

Garmin G5

Electronic Flight Instrument Part 23 AML STC Pilot's Guide





©2016-2017 Garmin International or its subsidiaries
All Rights Reserved

Except as expressly provided herein, no part of this manual may be reproduced, copied, transmitted, disseminated, downloaded or stored in any storage medium, for any purpose without the express prior written consent of Garmin. Garmin hereby grants permission to download a single copy of this manual and of any revision to this manual onto a hard drive or other electronic storage medium to be viewed and to print one copy of this manual or of any revision hereto, provided such electronic or printed copy of this manual or revision must contain the complete text of this copyright notice and provided further any unauthorized commercial distribution of this manual or any revision hereto is strictly prohibited.

Garmin® and flyGarmin® are registered trademarks of Garmin International or its subsidiaries. G5™ is a trademark of Garmin International or its subsidiaries. These trademarks may not be used without the express permission of Garmin.

Garmin International, Inc
1200 E. 151st Street Olathe, KS 66062 USA
Telephone: 913-397-8200
Technical Support and Field Service Engineers: 888.606.5482
www.flyGarmin.com

Garmin (Europe) Ltd.
Liberty House
Bull Copse Road
Hounsdown Business Park
Southampton, SO40 9LR, UK
Telephone: +44 (0) 23 8052 4000
Fax: +44 (0) 23 8052 4004

Garmin AT, Inc.
2345 Turner Rd. SE
Salem, OR 97302 USA
Telephone: 503.581.8101



RECORD OF REVISIONS

Revision	Revision Date	Description
1	7/21/16	Initial Release
2	4/19/17	Add G5 HSI



INFORMATION SUBJECT TO EXPORT CONTROL LAWS

This document may contain information which is subject to the Export Administration Regulations (“EAR”) issued by the United States Department of Commerce (15 CFR, Chapter VII, Subchapter C) and which may not be exported, released, or disclosed to foreign nationals inside or outside of the United States without first obtaining an export license. A violation of the EAR may be subject to a penalty of up to 10 years imprisonment and a fine of up to \$1,000,000 under Section 2410 of the Export Administration Act of 1979. Include this notice with any reproduced portion of this document.



NOTE:

The display uses a lens with a special coating that may be sensitive to skin oils, waxes, and abrasive cleaners. CLEANERS CONTAINING AMMONIA WILL HARM THE ANTI-REFLECTIVE COATING. It is very important to clean the lens using a clean, lint-free cloth and a cleaner that is specified as safe for anti-reflective coatings. Avoid any chemical cleaners or solvents that can damage plastic components.



NOTE:

Use of polarized eyewear may cause the display to appear dim or blank.



NOTE

All images used in this document are current at the time of publication but are subject to change and may not be up to date.



TABLE OF CONTENTS

<u>SECTION</u>	<u>PAGE</u>
1 SYSTEM DESCRIPTION.....	1
1.1 G5 Electronic Flight Instrument.....	1
1.2 Bezel Overview	2
1.3 microSD™ Cards	3
2 OPERATION	4
2.1 G5 Annunciations.....	4
2.2 G5 Attitude	5
2.3 G5 Heading	6
2.4 Backlight Intensity	6
3 ACCESSING FUNCTIONALITY	7
3.1 Pages	7
3.2 Menu	7
3.3 PFD Page.....	8
3.4 HSI Page.....	18
3.5 Navigation	21
4 SYSTEM MESSAGES	25



1 SYSTEM DESCRIPTION

1.1 G5 Electronic Flight Instrument

The G5 Electronic Flight Instrument is installed as an attitude display indicator (ADI) and/or horizontal situation indicator (HSI). The G5 contains integrated attitude/air data sensors that provide display of attitude and secondary display of air data information. The G5 can also be interfaced to an external sensor to provide heading information. The G5 features a bright, sunlight readable, 3.5-inch color display. In the case of aircraft power loss, the G5 battery sustains the G5 flight display with up to 4 hours of power.



G5 Electronic Flight Instrument (ADI)



G5 Electronic Flight Instrument (HSI)

1.2 Bezel Overview



G5 Bezel Overview

Power Button		Press to turn unit ON. Press and hold for 5 seconds to turn unit OFF. Once on, press to adjust the backlight.
microSD Card Slot		Insert microSD card to update software and log data.
Knob	Press	Press to access the Menu From the Menu, press to select the desired menu item. Press to accept the displayed value when editing numeric data or selecting from a list.
	Turn	From the Main Menu, turn the Knob to move the cursor to the desired menu item. For the ADI, rotate to adjust the barometric setting. For the HSI, rotate to adjust the heading or track bug. Turn to select the desired value when editing numeric data or selecting from a list.



1.3 microSD™ Cards

The G5 data card slot uses micro Secure Digital (SD) cards. The microSD™ card can be used for software updates and data logging. The maximum supported card size is 32GB.

Installing a microSD™ Card:

- 1) Insert the microSD™ card in the microSD™ card slot with the card contacts facing down (the card should be flush with the face of the bezel).
- 2) To eject the card, gently press on the microSD™ card to release the spring latch.

2 OPERATION

2.1 G5 Annunciations

When a G5 function fails, a large red 'X' is displayed over the instrument(s) or data experiencing the failure. Upon G5 power-up, certain instruments remain invalid as equipment begins to initialize. All instruments should be operational within one minute of power-up. If any instrument remains flagged and it is not likely an installation related problem, the G5 should be serviced by a Garmin-authorized repair facility.



G5 ADI Failure Indications



G5 HSI Failure Indications

2.2 G5 Attitude

The G5 calculates aircraft attitude using information from its built-in inertial sensors. The G5 also uses GPS and airspeed data to provide the most accurate attitude information. The G5 should display valid attitude within the first minute of power-up.

If the G5 senses that the attitude solution is valid, but not yet within the internal accuracy limits, "ALIGNING" is displayed. The displayed attitude information is still accurate and usable while this indication is shown. The G5 can align itself both while taxiing and during level flight.



Attitude Aligned Indication

If the G5 senses that the attitude solution is invalid, "ALIGNING KEEP WINGS LEVEL" is displayed. No attitude information is displayed while this indication is shown. The G5 can align itself both while taxiing and during level flight.



Attitude Aligned Keep Wings Level Indication

If the G5 inertial sensors fail, "ATTITUDE FAIL" is displayed in addition to a red-X flag. No attitude information is displayed while this indication is shown.



Attitude Failure Indication

2.3 G5 Heading

The G5 can display magnetic heading information received from the GMU 11 magnetometer. If magnetic heading input data is not available, the G5 will display GPS-derived ground track and the heading field will have a red-X displayed.



Heading Fail (ADI)



Heading Fail (HSI)

If both magnetic heading and GPS are unavailable, the heading field will have a red-X displayed and the compass card will be removed from the HSI.



Heading/Track Fail (ADI)



Heading/Track Fail (HSI)

The G5 corrects for shifts and variations in the Earth's magnetic field by applying the Magnetic Field Variation Database. The Magnetic Field Variation Database is derived from the International Geomagnetic Reference Field (IGRF). The IGRF is a mathematical model that describes the Earth's main magnetic field and its annual rate of change. The database is updated approximately every 5 years via a software update. Failure to update this database could lead to erroneous heading information being displayed to the pilot.

If the G5 senses that the magnetic heading measurement is valid but possibly outside of the internal accuracy limits, the numeric heading is displayed in yellow.

2.4 Backlight Intensity

When set to Auto, the backlight is automatically adjusted according to ambient light conditions. When set to Manual, the backlight level is set by the pilot.

Adjusting backlight intensity:

- 1) While the unit is turned on, press the **Power** Button.
- 2) Turn the Knob to adjust the backlight intensity.
- 3) Press the Knob to close the backlight page.

Setting the backlight intensity to automatic:

- 1) While the unit is turned on, press the Power Button.
- 2) Press the **Power** Button again to select **Auto**.
- 3) Press the Knob to close the backlight page.



3 ACCESSING FUNCTIONALITY

3.1 Pages

The G5 has two main pages, the PFD page and the HSI page. When installed as an ADI, the G5 displays the PFD Page only. When installed as an HSI, the G5 displays the HSI Page primarily but can display the PFD page as a backup to the ADI.



PFD Page



HSI Page

3.2 Menu

Press the Knob to access the G5 Menu. Navigate the menu by rotating the Knob and make selections by pressing the Knob.



PFD Page Menu



HSI Page Menu

3.3 PFD Page

The G5 PFD Page displays a horizon, airspeed, attitude, altitude, and vertical speed, as well as heading and course deviation information if combined with a G5 HSI.

The following flight instruments and supplemental flight data are displayed on the PFD Page:



G5 PFD Flight Instruments

- | | |
|-------------------------------|--|
| ① Airspeed Indicator | ⑫ Vertical Speed Indicator |
| ② Attitude Indicator | ⑬ Current Altitude |
| ③ Pitch Scale | ⑭ VNAV Indicator or Vertical Deviation Indicator |
| ④ Current Airspeed | ⑮ Altimeter |
| ⑤ Aircraft Symbol | ⑯ Selected Altitude |
| ⑥ Course Deviation Indicator | ⑰ Navigation Course |
| ⑦ Slip/Skid Indicator | ⑱ Current Heading or Ground Track |
| ⑧ Ground Speed (GS) | ⑲ Ground Track |
| ⑨ Altimeter Barometer Setting | ⑳ Selected Heading or Ground Track |
| ⑩ Turn Rate Indicator | ㉑ Vspeed Reference |
| ⑪ Selected Altitude Bug | ㉒ Battery Status Indicator |



3.3.1 Airspeed Indicator



NOTE:

The G5 Vspeed Reference values depend upon the aircraft's specific system configuration and may vary from the examples discussed in this section.

The Airspeed Indicator displays airspeed on a rolling number gauge using a moving tape. The numeric labels and major tick marks on the moving tape are marked at intervals of 10 MPH or KT, as indicated at bottom of airspeed tape). The actual airspeed is displayed inside the black pointer. The pointer remains black until reaching never-exceed speed (VNE), at which point it turns red.

A color-coded (red, white, green, yellow, and red/white “barber pole”) speed range strip is located on the moving tape. The colors denote flaps operating range, normal operating range, caution range, and never-exceed speed (VNE). A red range is also present for low speed awareness.

The Airspeed Trend Vector is a vertical, magenta line, extending up or down on the airspeed scale, shown to the right of the color-coded speed range strip. The end of the trend vector corresponds to the predicted airspeed in 6 seconds if the current rate of acceleration is maintained. If the trend vector crosses VNE, the text of the actual airspeed readout changes to yellow. The trend vector is absent if the speed remains constant or if any data needed to calculate airspeed is not available due to a system failure.

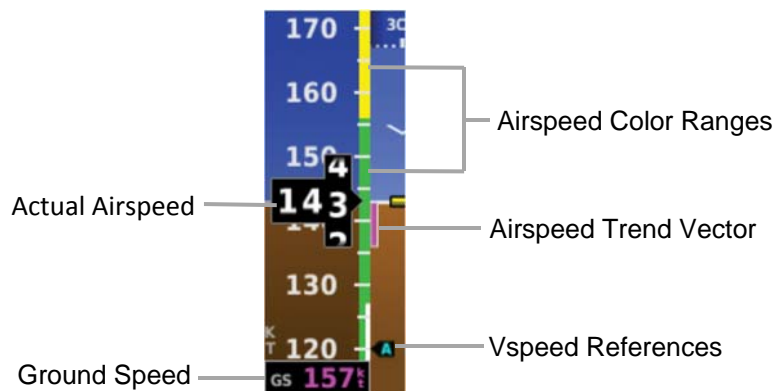

Airspeed Indicator



3.3.2 Vspeed Reference

Vspeed references including V_{NE} , V_{no} , V_{so} , V_{s1} , V_{fe} , V_a , V_x , V_y , V_{Yse} , V_g , V_r , are displayed on the G5 (as configured during installation.)

When airspeed is present, the Vspeeds configured are displayed at their respective locations to the right of the airspeed scale; otherwise, the Vspeeds are displayed at the bottom of the airspeed indicator.

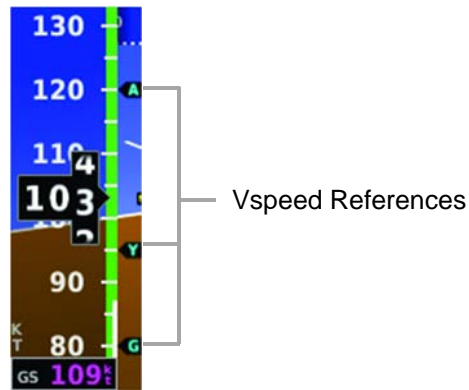

Vspeed References

3.3.3 Attitude Indicator

Attitude information is displayed over a virtual blue sky and brown ground with a white horizon line. The Attitude Indicator displays the pitch (indicated by the yellow symbolic aircraft on the pitch scale), roll, and slip/skid information.

The horizon line is part of the pitch scale. Pitch markings occur at 2.5° intervals through all pitch ranges. When the aircraft enters an unusual pitch attitude, red extreme pitch warning chevrons pointing toward the horizon are displayed on the Attitude Indicator starting at 60° above and 40° below the horizon line.

The inverted white triangle indicates zero on the roll scale. Major tick marks at 30° and 60° and minor tick marks at 10°, 20°, and 45° are shown to the left and right of the zero. Angle of bank is indicated by the position of the pointer on the roll scale.

Slip/skid is indicated by the location of the ball.

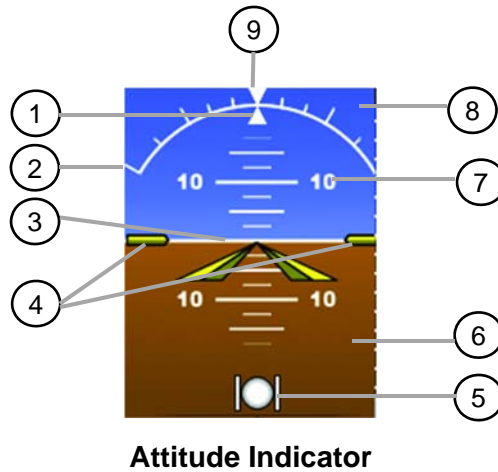

- ① Roll Pointer
- ② Roll Scale
- ③ Horizon Line
- ④ Aircraft Symbol
- ⑤ Slip/Skid Indicator
- ⑥ Land Representation
- ⑦ Pitch Scale
- ⑧ Sky Representation
- ⑨ Roll Scale Zero



3.3.4 Altimeter

The Altimeter displays 400 feet of barometric altitude values at a time on a rolling number gauge using a moving tape. Numeric labels and major tick marks are shown at intervals of 100 feet. Minor tick marks are at intervals of 20 feet. The current altitude is displayed in the black pointer. The Selected Altitude is displayed above the Altimeter in the box indicated by a selection bug symbol. A bug corresponding to this altitude is shown on the tape. If the Selected Altitude exceeds the range shown on the tape, the bug appears at the corresponding edge of the tape.

Setting the selected altitude:

- 1) Press the Knob to display the Menu.
- 2) Select **Altitude** and use the Knob to change the Selected Altitude.

Syncing to the current altitude:

- 1) Press the Knob to display the Menu.
- 2) Select **Altitude** and press and hold the Knob to sync the Selected Altitude to the current altitude.

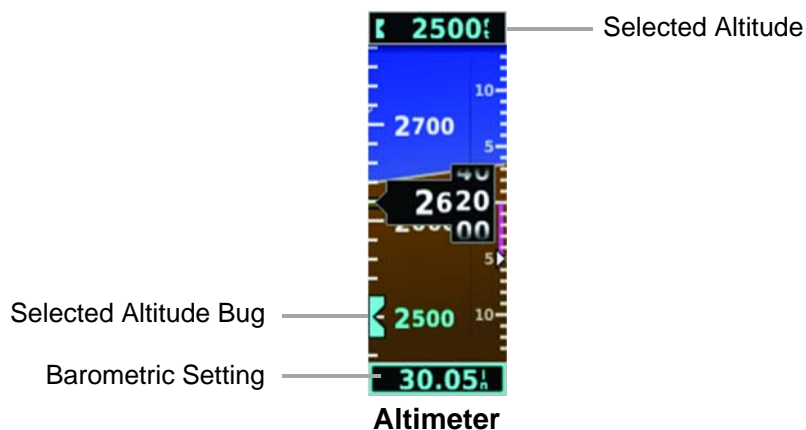

3.3.5 Barometric Pressure

The barometric pressure setting is displayed below the Altimeter in inches of mercury (in Hg).

Selecting the altimeter barometric pressure setting:

Turn the Knob to set the barometric pressure.



3.3.6 Altitude Alerting

The Altitude Alerting function provides the pilot with a visual alert when approaching the Selected Altitude. Whenever the Selected Altitude is changed, the Altitude Alerter is reset. The following will occur when approaching the Selected Altitude:

- Passing within 1000 feet of the Selected Altitude, the Selected Altitude (shown above the Altimeter) flashes for 5 seconds.
- When the aircraft passes within 200 ft of the Selected Altitude, the Selected Altitude flashes for 5 seconds to indicate that the aircraft is approaching the selected altitude.
- After reaching the Selected Altitude, if the pilot flies outside the deviation band (± 200 Feet of the Selected Altitude), the Selected Altitude changes to yellow text on a black background, flashes for 5 seconds.

Deviation of ± 200 ft

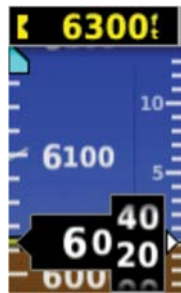

Altitude Alerting Visual Annunciation

3.3.7 Turn Rate Indicator

The Turn Rate Indicator is located at the bottom of the PFD Page. A magenta Turn Rate Trend Vector shows the current turn rate. A standard-rate turn (3 deg/sec) is shown on the indicator by the trend vector stopping at the standard turn rate tick mark.



Turn Rate
Trend Vector

Turn Rate Indicator
(Standard Rate Tick Marks)

Turn Rate Indicator

3.3.8 Heading/Ground Track

A Heading/Ground Track Tape is displayed at the top of the PFD Page and displays numeric labels every 10°. Major tick marks are at 5° intervals and minor tick marks at 1° intervals. Heading is displayed if a G5 HSI is installed and magnetometer data is available; otherwise, Track is displayed. The current track is represented by a magenta triangle. The Heading/Ground Track Tape also displays the navigation course.

When displaying Selected Heading, a light blue bug on the tape corresponds to the selected heading. When displaying Ground Track, a magenta bug is displayed on the tape.

Adjusting the selected heading or ground track:

- 1) Press the Knob to display the Menu.
- 2) Select **Heading** or **Track** and use the Knob to change the selected heading or track.

Syncing to the current heading or ground track:

- 1) Press the Knob to display the Menu.
- 2) Select **Heading** or **Track** and press and hold the Knob to sync the selected heading or ground track to the current heading or ground track.

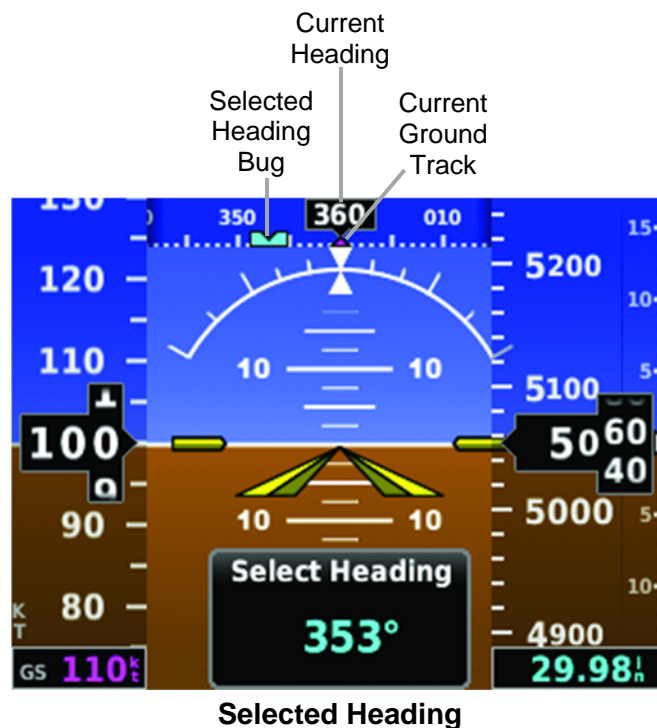

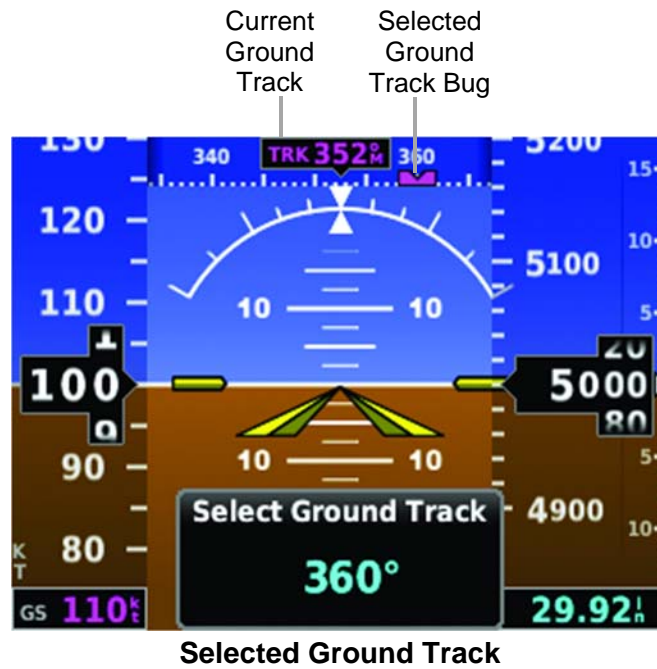

3.3.9 Vertical Speed Indicator (VSI)

The Vertical Speed Indicator displays the aircraft vertical speed using a non-moving tape to the right of the altimeter. The current vertical speed is displayed using a white arrow along the tape.

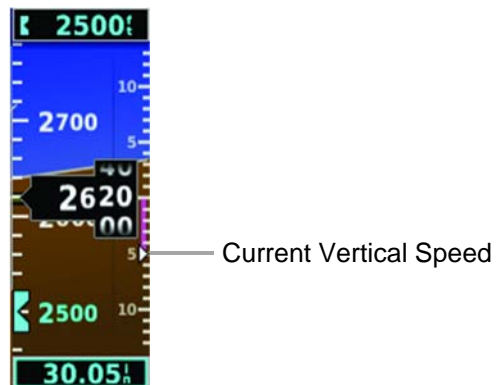

Vertical Speed Indicator



3.3.10 Battery Status Indicator

When the G5 is powered by the battery, the estimated time until the battery is empty is displayed in hours and minutes. The current charge level of the battery is indicated by the filled-in portion of the battery icon. The battery icon turns yellow or red to indicate a low-battery condition.



The battery is required for the G5 unit installed as an attitude display indicator (ADI) and is optional for the G5 unit installed as a horizontal situation indicator (HSI).

Other battery indications:

	<p>Battery charger hardware fault, or temperature too high or low to charge the battery safely</p>
	<p>Battery fault</p>
	<p>Battery is not present</p>

3.4 HSI Page

The G5 HSI Page displays a rotating compass card in a heading-up orientation. Letters indicate the cardinal points and numeric labels occur every 30°. Major tick marks are at 10° intervals and minor tick marks at 5° intervals. The current ground track is represented on the HSI by magenta triangle and a dashed line. The HSI also presents course deviation, bearing, and navigation source information. The following items are displayed on the HSI Page:

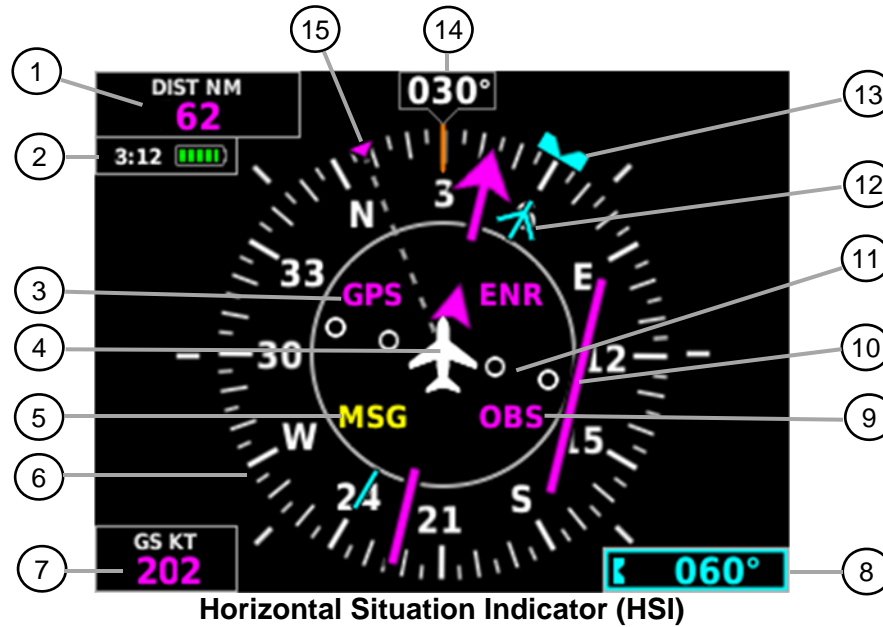

Horizontal Situation Indicator (HSI)

- | | |
|----------------------------|------------------------------------|
| ① Distance to Waypoint | ⑧ Selected Heading |
| ② Battery Status Indicator | ⑨ OBS Annunciator |
| ③ Navigation Source | ⑩ Course Deviation Indicator (CDI) |
| ④ Aircraft Symbol | ⑪ GPS CDI Scale |
| ⑤ Navigator Messages | ⑫ Bearing Pointer |
| ⑥ Rotating Compass Rose | ⑬ Heading Bug |
| ⑦ Ground Speed (GS) | ⑭ Current Heading |
| | ⑮ Current Ground Track Indicator |

③ Nav Source Annunciations				⑪ GPS CDI Scale Annunciations		
GPS/ GPS1/ GPS2	VLOC/ VLOC1/ VLOC2	VOR/ VOR1 VOR2	LOC/ LOC1/ LOC2	LP	LPV	LNAV
				LNAV/VNAV	LNAV+V	APR
				TERM	ENR	OCN
⑤ Navigator Messages Annunciations						
LOI	Loss of GPS Integrity			MSG	Pending Nav Message	
DR	GPS Dead-Reckoning Mode			WPT	Waypoint Arrival	

3.4.1 Bearing Pointer

A bearing pointer can be displayed on the HSI for NAV (VOR) and GPS sources. The bearing pointer is cyan. The bearing pointer never overrides the CDI and is visually separated from the CDI by a white ring (shown when the bearing pointer is selected but not necessarily visible due to data unavailability).



HSI Page with Bearing Pointer

Enabling/disabling the bearing pointer:

- 1) From the HSI Page, press the **Knob** to display the Menu.
- 2) Turn the **Knob** to highlight **Bearing Pointer**.
- 3) Press the **Knob** to enable or disable the Bearing Pointer.



Bearing Pointer Menu Option

3.4.2 Heading/Ground Track

The Selected Heading or Ground Track is shown to the right of the HSI. The cyan bug (heading) or magenta bug (ground track) on the compass rose corresponds to the Selected Heading or Ground Track. Heading is displayed if magnetometer data is available; otherwise, Ground Track is displayed.

Adjusting the selected heading or ground track from the HSI page:

Turn the Knob to adjust the selected heading or ground track.

Syncing to the current heading or ground track from the HSI page:

Press and hold the Knob to sync to the current heading or ground track.



Selected Heading



Selected Ground Track

3.5 Navigation

The G5 will only display data from the #1 navigation source. If the navigation source is a GNS/GTN unit, both GPS and VLOC data can be displayed.

3.5.1 Course Deviation Indicator (CDI)

The PFD Page displays the Course Deviation Indicator (CDI) above the slip/skid indicator. The HSI contains a Course Deviation Indicator (CDI) with a Course Pointer. The course pointer (GPS or VLOC) points in the direction of the selected course.

The Course Deviation Indicator (CDI) moves left or right along a lateral deviation scale to display aircraft position relative to the course. If the course deviation data is not valid, the CDI is not displayed.

The CDI is capable of displaying two sources of navigation: GPS or NAV (VOR, localizer). Color indicates the current navigation source: magenta (for GPS) or green (for VOR and LOC). The full-scale limits for the CDI are defined by a GPS-derived distance when coupled to GPS. When coupled to a VOR or localizer (LOC), the CDI has the same angular limits as a mechanical CDI.

Changing the navigation source (GPS, VOR, LOC, or VLOC):

Use the #1 external navigator to toggle between GPS and VOR/LOC source types.



Course Deviation Indicator (PFD Page)



Course Deviation Indicator (HSI Page)

3.5.2 Vertical Deviation (Glideslope) Indicator - ILS Source

The Vertical Deviation (Glideslope) Indicator (VDI) appears to the left of the altimeter (PFD page) and to the right of the compass rose (HSI page) whenever an ILS frequency is tuned in the active NAV field of an external navigator. A green diamond acts as the VDI, like a glideslope needle on a conventional indicator. If a localizer frequency is tuned and there is no glideslope signal, "NO GS" is annunciated.

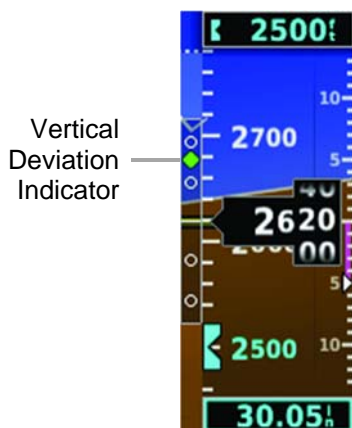

**Vertical Deviation Indicator
(Glideslope ILS Source)
(PFD Page)**

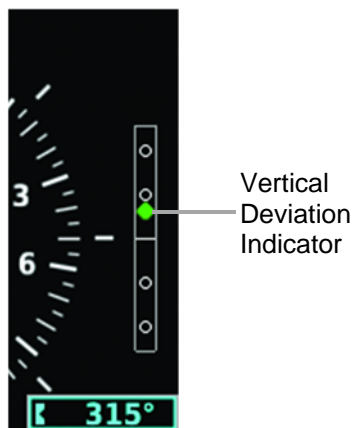

**Vertical Deviation Indicator
(Glideslope ILS Source)
(HSI Page)**

3.5.3 Vertical Deviation (Glidepath) Indicator - GPS Source

The Vertical Deviation (Glidepath) Indicator (VDI) also appears to the left of the altimeter (PFD page) and to the right of the compass rose (HSI page) during a GPS approach. The glidepath is analogous to the glideslope for GPS approaches supporting WAAS vertical guidance (LNAV+V, L/VNAV, LPV). The Glidepath Indicator appears on the G5 as a magenta diamond. If the approach type downgrades past the final approach fix (FAF), "NO GP" is annunciated.

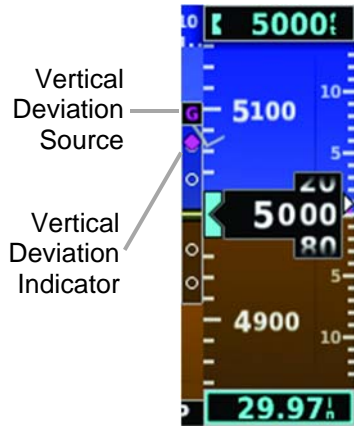

**Vertical Deviation Indicator
(Glidepath GPS Source)
(PFD Page)**

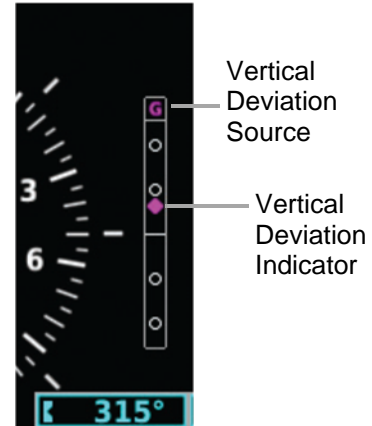

**Vertical Deviation Indicator
(Glidepath GPS Source)
(HSI Page)**

3.5.4 VNAV Indicator

The magenta chevron (VNAV Indicator) to the left of the altimeter (PFD page) and to the right of the compass rose (HSI page) on the Vertical Deviation Scale displays the VNAV profile.

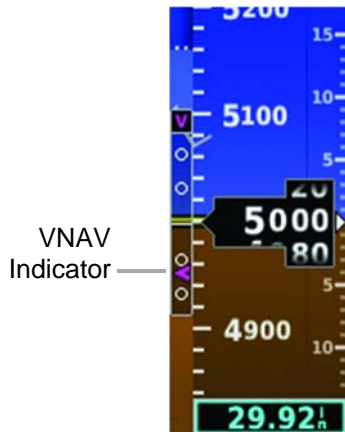

**VNAV Indicator
(PFD Page)**

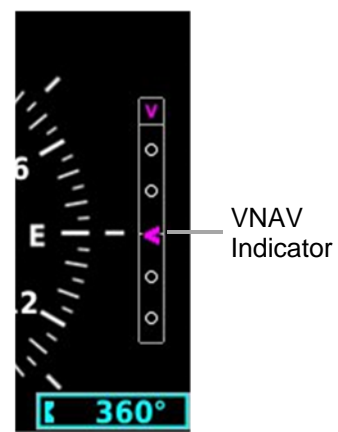

**VNAV Indicator
(HSI Page)**

3.5.5 Course Selection

When the G5 is receiving VOR or LOC data, a **Course** menu option is displayed.

Setting the course for a VOR or localizer:

- 1) From the HSI Page, press the Knob to display the Menu.
- 2) Select **Course** and use the Knob to adjust the course.

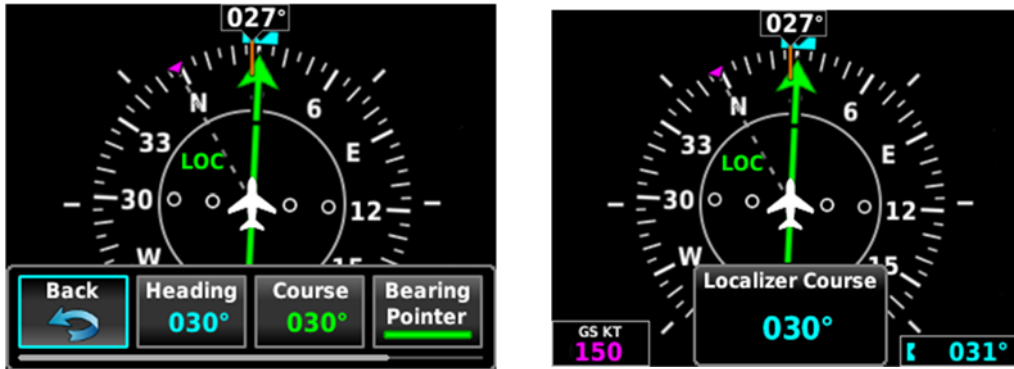

Course on HSI Page

3.5.6 OBS Selection

When OBS is activated on the navigator, an **OBS** menu option is displayed.

Setting the OBS:

- 1) From the HSI Page, press the Knob to display the Menu.
- 2) Select **OBS** and use the Knob to adjust the OBS (course).

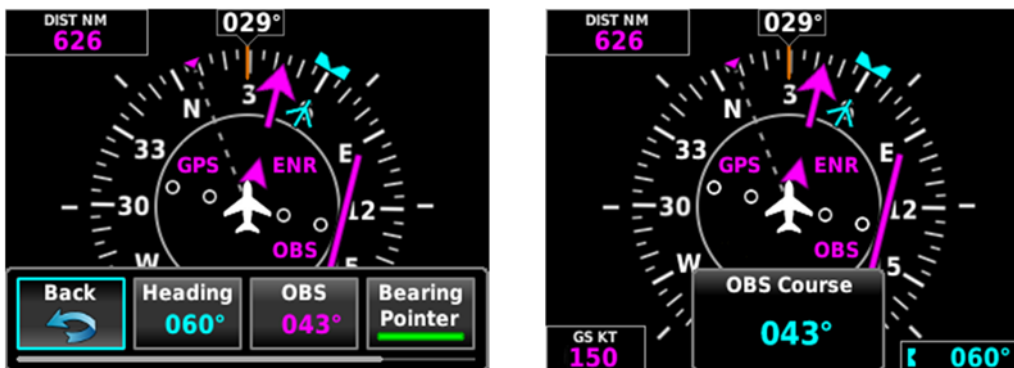

OBS on HSI Page



4 SYSTEM MESSAGES

The following table shows G5 system messages that may appear along the bottom of the display. These messages remain while the condition persists or until cleared by pressing the knob.

<i>Message</i>	<i>Meaning</i>
External Power Lost	Aircraft power has been removed from the G5
Critical battery fault! Powering off...	Battery has critical fault condition and the unit is about to power off to avoid damage to the battery.
Battery fault	Battery has a fault condition - contact Garmin if it persists.
Battery charger fault	Battery charger has a fault condition - contact Garmin if it persists.
Low battery	Battery charge level is low
Hardware fault	Unit has a hardware fault - contact Garmin for service
Power supply fault	Unit power supply fault detected - contact Garmin for service if it persists
Unit temperature limit exceeded	Unit is too hot or too cold
Network address conflict	Another G5 with the same address is detected on the network (most commonly a wiring error on one of the units)
Communication error	General communication error (most commonly appears in conjunction with Network Address Conflict message)
Factory calibration data invalid	Unit calibration data not valid - return to Garmin
Magnetic field model database out of date	Internal magnetic field database is out of date - software update required
Using external GPS data	GPS data from another network LRU is being used. The unit's internal GPS receiver is enabled, but unable to establish a GPS fix