

Edge[®] 810

Quick Start Manual



Introduction

⚠ WARNING

See the *Important Safety and Product Information* guide in the product box for product warnings and other important information.

Always consult your physician before you begin or modify any exercise program.

Getting Started

When using your device the first time, you should complete these tasks to set up the device and learn about the basic features.

- 1 Install your device using the standard mount (page 2) or the out-front mount (page 2).
- 2 Turn on the device (page 3).
- 3 Locate satellites (page 3).
- 4 Go for a ride (page 3).
- 5 Charge the device (page 2).
- 6 Register the device (page 6).
- 7 Upload your ride to Garmin Connect™ (page 4).
- 8 Get the owner's manual (page 6).

Charging the Device

NOTICE

To prevent corrosion, thoroughly dry the mini-USB port, the weather cap, and the surrounding area before charging or connecting to a computer.

The device is powered by a built-in lithium-ion battery that you can charge using a standard wall outlet or a USB port on your computer.

NOTE: The device will not charge when outside the temperature range of 32° to 113°F (0° to 45°C).

- 1 Pull up the weather cap ① from the mini-USB port ②.



- 2 Plug the small end of the USB cable into the mini-USB port.
- 3 Plug the USB end of the cable into the AC adapter or a computer USB port.
- 4 Plug the AC adapter into a standard wall outlet.
When you connect the device to a power source, the device turns on.
- 5 Charge the device completely.

A fully charged battery can run for up to 15 hours before it must be recharged.

Installing the Standard Mount

For the best GPS reception, position the bike mount so the front of the Edge is oriented toward the sky. You can install the bike mount on the stem or the handlebars.

- 1 Select a secure location to mount the Edge where it does not interfere with the safe operation of your bike.

- 2 Place the rubber disk ① on the back of the bike mount.
The rubber tabs align with the back of the bike mount so it stays in place.

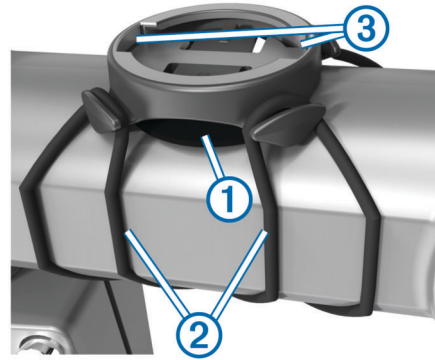

- 3 Place the bike mount on the bike stem.
- 4 Attach the bike mount securely using the two bands ②.
- 5 Align the tabs on the back of the Edge with the bike mount notches ③.
- 6 Press down slightly and turn the Edge clockwise until it locks into place.



Installing the Out-Front Mount

- 1 Select a secure location to mount the Edge where it does not interfere with the safe operation of your bike.
- 2 Use the hex key to remove the screw ① from the handlebar connector ②.

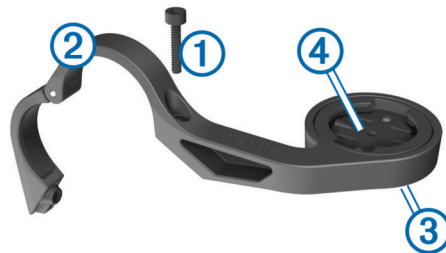

- 3 If you want to change the orientation of the mount, remove the two screws on the back side of the mount ③, rotate the connector ④, and replace the screws.
- 4 If the handlebar diameter is 26 mm, place the rubber pad around the handlebar.
- 5 Place the handlebar connector around the rubber pad or handlebar (31.8 mm diameter).
- 6 Replace the screw.
NOTE: Garmin® recommends a torque specification of 7 lbf-in. (0.8 N-m). Check the tightness of the screw periodically.
- 7 Align the tabs on the back of the Edge with the bike mount notches ⑤.

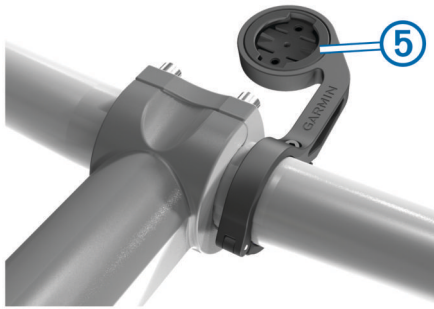

8 Press down slightly and turn the Edge clockwise until it locks into place.

Releasing the Edge

- 1 Turn the Edge clockwise to unlock the device.
- 2 Lift the Edge off the mount.

Turning On the Device



The first time you turn on the device, you are prompted to configure system settings and profiles (page 6).

- 1 Hold .
- 2 Follow the on-screen instructions.
- 3 If your device included a heart rate monitor and a GSC™ 10, activate the ANT+™ sensors during configuration.

For more information about ANT+ sensors, see page 5.





Keys



①		Select to turn the backlight on and off. Hold to turn the device on and off.
②		Select to mark a new lap.
③		Select to start and stop the timer.











Home Screen Overview

The home screen gives you quick access to all the features of the Edge.

 Bike 1 >	Select to change your bike profile.
RIDE	Select to go for a ride.
Road >	Select to change your activity profile.
	Select to manage your history, courses, workouts, and personal records.
	Select to view the map.
	Select to view the setup menu.

Using the Touchscreen

- When the timer is running, tap the screen to view the timer overlay.
The timer overlay allows you to use the settings and search features during a ride.

- Select  to save your changes and close the page.
- Select  to close the page and return to the previous page.
- Select  to return to the previous page.
- Select  to return to the home screen.
- Select  and  to scroll.
- Select  to view the connections page.
- Select  to search for a location.
- Select  to search near a location.
- Select  to search by name.
- Select  to delete an item.

Viewing the Connections Page

The connections page displays the status of the satellite signals, ANT+ sensors, and your smartphone.

From the home screen, select the status bar at the top of the page.

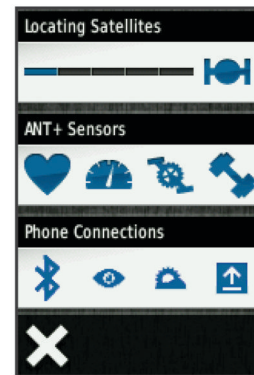

The connections page appears. A flashing icon means the device is searching. You can select any icon to change the settings.

Acquiring Satellite Signals

Before you can use the GPS tracking and navigation features, you must acquire satellite signals.

The device may need a clear view of the sky to acquire satellite signals. The time and date are set automatically based on the GPS position.

- 1 Go outdoors to an open area.
The front of the device should be oriented toward the sky.
- 2 From the home screen, select **RIDE**.
- 3 Wait while the device locates satellites.
It may take 30–60 seconds to locate satellite signals.

TIP: Do not begin moving until the timer page appears (page 3).

Going for a Ride

Before you can record speed and distance, you must locate satellite signals (page 3) or pair your device with an optional ANT+ sensor.

NOTE: History is recorded only while the timer is running.

- 1 From the home screen, select **RIDE**.
- 2 Wait while the device locates satellites.
- 3 Select  to start the timer.

Time 01:08:43	
Speed 18.2^m	
Distance 20.23^m	
Elevation 1087^f	Totl. Ascent 1155^f
Cadence 83^r_p_m	Heart Rate 163^b_p_m

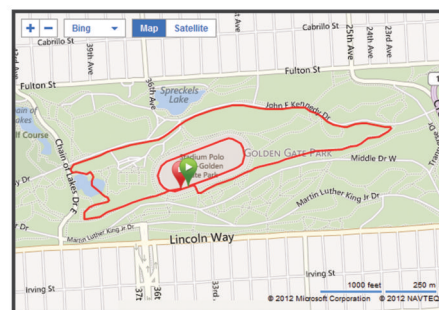

Share your activities: You can email your activities to others, or post links to your activities on your favorite social networking sites.

Connected Features

The Edge has several connected features for your compatible Bluetooth®-enabled smartphone. For more information about how to use your Edge, go to www.garmin.com/intosports/apps.

NOTE: Your Edge must be connected to your Bluetooth-enabled smartphone to take advantage of these features.

LiveTrack: Allows friends and family to follow your races and training activities in real time. You can invite followers using email or social media, allowing them to view your live data on a Garmin Connect tracking page.

Activity upload to Garmin Connect: Automatically sends your activity to Garmin Connect as soon as you finish recording the activity.

Course and workout downloads from Garmin Connect: Allows you to search for activities on Garmin Connect using your smartphone and send them to your device so that you can repeat them as a course or workout.

Social media interactions: Allows you to automatically post an update to your favorite social media website when you upload an activity to Garmin Connect.

Weather updates: Sends real-time weather conditions and alerts to your device.

Following a Course From the Web

Before you can download a course from Garmin Connect, you must have a Garmin Connect account ([page 4](#)).

- 1 Connect the device to your computer.
- 2 Go to www.garminconnect.com.
- 3 Create a new course or select an existing course.
- 4 Select **Send to Device**.
- 5 Disconnect the device, and turn it on.
- 6 Select **■** > **Courses**.
- 7 Select the course.
- 8 Select **RIDE**.

Locations

You can record and store locations in the device.

Saving Your Location

You can save your present location, such as your home or parking spot.

From the home screen, select **✕** > **System** > **GPS** > **Mark Location** > **✓**.

History

History includes time, distance, calories, speed, lap data, elevation, and optional ANT+ sensor information.

NOTE: History is not recorded while the timer is stopped or paused.

- 4 Swipe the screen for additional data pages.
- 5 If necessary, tap the screen to view the timer overlay.
- 6 Select **▶** to stop the timer.
- 7 Select **Save**.

Sending Your Ride to Garmin Connect

NOTICE

To prevent corrosion, thoroughly dry the mini-USB port, the weather cap, and the surrounding area before charging or connecting to a computer.

- 1 Pull up the weather cap ① from the mini-USB port ②.



- 2 Plug the small end of the USB cable into the mini-USB port.
- 3 Plug the large end of the USB cable into a computer USB port.
- 4 Go to www.garminconnect.com.
- 5 Select **Getting Started**.
- 6 Follow the on-screen instructions.

Garmin Connect

Garmin Connect gives you a simple way to store and track your activities, analyze your data, and share with others. To sign up for a free account, go to www.garminconnect.com/start.

Store your activities: After you complete and save an activity with your device, you can upload that activity to Garmin Connect and keep it as long as you want.

Analyze your data: You can view more detailed information about your activity, including an overhead map view, pace and speed charts, and customizable reports.

When the device memory is full, a message appears. The device does not automatically delete or overwrite your history. Upload your history to Garmin Connect periodically to keep track of all your ride data.

Viewing Your Ride

- 1 From the home screen, select **Rides**.
- 2 Select **Last Ride** or **All Rides**.
- 3 Select an option.

Deleting History

- 1 From the home screen, select **Delete**.
- 2 Select an option:
 - Select **All Rides** to delete all saved activities from the history.
 - Select **Old Rides** to delete activities recorded more than one month ago.
 - Select **All Totals** to reset all distance and time totals.

NOTE: This does not delete any saved activities.
 - Select **All Courses** to delete all courses you have saved or transferred to the device.
 - Select **All Workouts** to delete all workouts you have saved or transferred to the device.
 - Select **All Personal Records** to delete all personal records saved to the device.

NOTE: This does not delete any saved activities.
- 3 Select **✓**.

ANT+ Sensors

Your device can be used with wireless ANT+ sensors. For more information about compatibility and purchasing optional sensors, go to <http://buy.garmin.com>.

Putting On the Heart Rate Monitor

NOTE: If you do not have a heart rate monitor, you can skip this task.

You should wear the heart rate monitor directly on your skin, just below your breastplate. It should be snug enough to stay in place during your activity.

- 1 Snap the heart rate monitor module **1** onto the strap.



- 2 Wet both electrodes **2** on the back of the strap to create a strong connection between your chest and the transmitter.



- 3 If the heart rate monitor has a contact patch **3**, wet the contact patch.
- 4 Wrap the strap around your chest, and connect the strap hook **4** to the loop.

The Garmin logo should be right-side up.
- 5 Bring the device within range (3 m) of the heart rate monitor.

After you put on the heart rate monitor, it is on standby and ready to send data.

TIP: If the heart rate data is erratic or does not appear, you may have to tighten the strap on your chest or warm up for 5–10 minutes.

Installing the GSC 10

NOTE: If you do not have a GSC 10, you can skip this task. Both magnets must be aligned with their respective indication lines for the Edge to receive data.

- 1 Place the GSC 10 on the rear chain stay (on the side opposite the drive train).
- 2 If necessary, place the flat rubber pad **1** or the triangle-shaped rubber pad between the GSC 10 and the chain stay for stability.

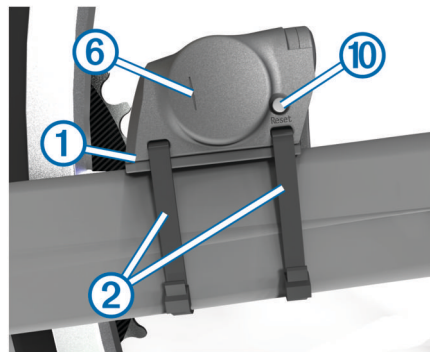

- 3 Loosely attach the GSC 10 using two cable ties **2**.
- 4 Attach the pedal magnet **3** to the crank arm using the adhesive mount and a cable tie **4**.

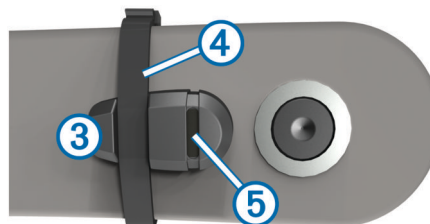

The pedal magnet must be within 5 mm of the GSC 10. The indication line **5** on the pedal magnet must line up with the indication line **6** on the GSC 10.

- 5 Unscrew the spoke magnet **7** from the plastic piece.

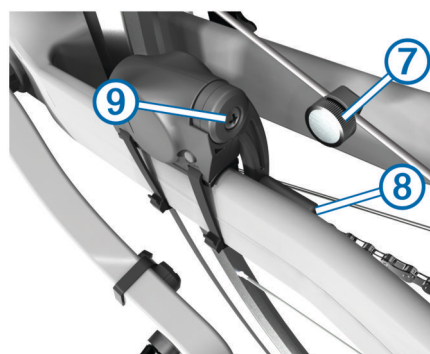

- 6 Place the spoke in the groove of the plastic piece, and tighten it slightly.

The spoke magnet can face away from the GSC 10 if there is not enough room between the sensor arm and the spoke. The spoke magnet must line up with the indication line **8** on the sensor arm.
- 7 Loosen the screw **9** on the sensor arm.
- 8 Move the sensor arm to within 5 mm of the spoke magnet. You can also tilt the GSC 10 closer to either magnet to improve alignment.
- 9 Select **Reset** **10** on the GSC 10.

The LED turns red, then green.

10 Pedal to test the sensor alignment.

The red LED blinks each time the pedal magnet passes the sensor. The green LED blinks each time the spoke magnet passes the sensor arm.

NOTE: The LED blinks for the first 60 passes after a reset. Select **Reset** again if you require additional passes.

11 When everything is aligned and working correctly, tighten the cable ties, the sensor arm, and the spoke magnet.

Garmin recommends that the torque is 1.9 to 2.4 lbf-in. (0.21 to 0.27 N-m) to ensure a water tight seal on the GSC 10 sensor arm.

Training with Power Meters

- Go to www.garmin.com/intosports for a list of third-party ANT+ sensors that are compatible with your device.
- For more information, see your owner's manual.

Customizing the Device

Profiles

The Edge has several ways for you to customize the device including profiles. Profiles are a collection of settings that optimize your device based on how you are using it. For example, you can create different settings and views for training and mountain biking.

When you are using a profile and you change settings such as data fields or units of measurement, the changes are saved automatically as part of the profile.

Bike Profiles: You can create bike profiles for each bike you own. The bike profile includes optional ANT+ sensors, bike weight, wheel size, odometer value, and crank length.

Activity Profiles: You can create activity profiles for each type of biking. For example, you can have a profile for training, racing, and mountain biking. The activity profile includes customized data pages, alerts, training zones (such as heart rate and speed), training settings (such as **Auto Pause** and **Auto Lap**), and navigation settings.

User Profile: You can update your gender, age, weight, height, and lifetime athlete settings. The device uses this information to calculate accurate ride data.

Customizing the Data Pages

You can customize data pages for each activity profile ([page 6](#)).

- 1 From the home screen, select **✖** > **Activity Profiles**.
- 2 Select a profile.
- 3 Select **Training Pages**.
- 4 Select a data page.
- 5 If necessary, enable the data page.
- 6 Select the number of data fields you want to see on the page.
- 7 Select **✓**.
- 8 Select a data field to change it.
- 9 Select **✓**.

Troubleshooting

Registering Your Device

Help us better support you by completing our online registration today.

- Go to <http://my.garmin.com>.
- Keep the original sales receipt, or a photocopy, in a safe place.

Resetting the Device

If the device stops responding, you may need to reset it. This does not erase any of your data or settings.

- 1 Hold **⏻** for 10 seconds.
- 2 Hold **⏻** for one second to turn on the device.

Clearing User Data

You can restore all of the device settings to the factory default values.

NOTE: This deletes all user-entered information, but it does not delete your history.

- 1 Turn off the device.
- 2 Place your finger on the top left corner of the touchscreen.
- 3 While holding your finger on the touchscreen, turn on the device.
- 4 Select **✓**.

Locking the Touchscreen

You can lock the screen to prevent inadvertent screen touches.

- 1 Select **⏻**.
- 2 Select **🔒**.

Unlocking the Touchscreen

- 1 Select **⏻**.
- 2 Select **🔒**.

Getting More Information

- Go to www.garmin.com/intosports.
- Go to www.garmin.com/learningcenter.
- Go to <http://buy.garmin.com>, or contact your Garmin dealer for information about optional accessories and replacement parts.

Getting the Owner's Manual

You can get the latest owner's manual from the web.

- 1 Go to www.garmin.com/support.
- 2 Select **Manuals**.
- 3 Follow the on-screen instructions to select your product.

Getting the Owner's Manual from the Device

- 1 Connect the device to your computer using the USB cable.
- 2 Open the **Garmin** drive or volume.
- 3 Open the **Garmin > Documents** folder or volume.
- 4 Double-click **START HERE.html**.

www.garmin.com/support



913-397-8200
1-800-800-1020



0808 2380000
+44 870 850 1242



1-866-429-9296



43 (0) 3133 3181 0



00 32 2 672 52 54



00 45 4810 5050



00 358 9 6937 9758

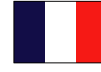

00 331 55 69 33 99



0180 5 / 42 76 46 - 880



00 39 02 3669 9699



0800-0233937



815 69 555



00800 4412 454
+44 2380 662 915



00 35 1214 447 460



00 34 902 007 097



00 46 7744 52020

Garmin International, Inc.

1200 East 151st Street
Olathe, Kansas 66062, USA

Garmin (Europe) Ltd.

Liberty House, Hounslow Business Park
Southampton, Hampshire, SO40 9LR UK

Garmin Corporation

No. 68, Zhangshu 2nd Road, Xizhi Dist.
New Taipei City, 221, Taiwan (R.O.C.)

Edge®, Garmin®, and the Garmin logo are trademarks of Garmin Ltd. or its subsidiaries, registered in the USA and other countries. ANT+™, Garmin Connect™, and GSC™ are trademarks of Garmin Ltd. or its subsidiaries. These trademarks may not be used without the express permission of Garmin.

The Bluetooth® word mark and logos are owned by the Bluetooth SIG, Inc. and any use of such marks by Garmin is under license. Other trademarks and trade names are those of their respective owners.

TRA
REGISTERED No:
ER0093823/12
DEALER No:
0015955/08

