



GPS III
PLUS

Owner's Manual & Reference



GARMIN International, 1200 E. 151st Street, Olathe, Kansas 66062 USA
Tel: 913/397.8200 Fax: 913/397.8282

GARMIN (Europe) Ltd., Unit 5, The Quadrangle, Abbey Park, Romsey, Hampshire SO51 9AQ UK
Tel: 44/1794.519944 Fax: 44/1794.519222

GARMIN Corporation, No. 68, Jangshu 2nd Road, Shijr, Taipei County, Taiwan
Tel: 886/2/2642.9199 Fax: 886/2.2642.9099

Web Site Address: www.garmin.com

© 1999-2001 GARMIN Corporation. All rights reserved. Except as expressly provided herein, no part of this manual may be reproduced, copied, transmitted, disseminated, downloaded or stored in any storage medium, for any purpose without prior written consent of GARMIN Corporation. GARMIN Corporation hereby grants permission to download a single copy of this manual onto a hard drive or other electronic storage medium to be viewed for personal use, provided that such electronic or printed copy of this manual contains the complete text of this copyright notice and provided further that any unauthorized commercial distribution of this manual is strictly prohibited.

GARMIN®, Autolocate®, TracBack®, and Phasetrac 12® are registered trademarks and MapSource™ is a trademark of GARMIN Corporation and may not be used without the express permission of GARMIN Corporation.

Information in this manual is subject to change without notice. GARMIN Corporation reserves the right to change or improve its products and to make changes in the content without obligation to notify any person or organization of such changes. Visit the GARMIN web site (www.garmin.com) for current updates and supplemental information concerning the use and operation of this and other GARMIN products.

Thank You!

Thank you for choosing the GARMIN GPS III+ — an easy-to-use GPS navigator for marine, automotive and outdoor use! The GPS III+ represents GARMIN's continuing commitment to provide quality navigation information in a versatile and user-friendly flexible design you'll enjoy for years. To get the most from your new GPS, take the time to read through the owner's manual in order to understand the operating features of the GPS III+. This manual is organized into three sections for your convenience:

Section One (Getting Started) introduces you to the basic features of the unit and provides a quick-start orientation to the GPS III+.

Section Two (Simulator Tour) provides a step-by-step lesson in how your new GPS III+ would operate in the real world by utilizing the built-in simulator mode.

Section Three (Reference) provides details about the advanced features and operations of the GPS III+ by topic.

Before getting started with your GPS, check to see that your GARMIN GPS III+ package includes the following items. If you are missing any parts, please contact your dealer immediately.

Standard Package:

- GPS III+ Unit with Detachable Antenna
- Wrist Strap
- GPS III+ Owner's Manual
- Quick Reference Card
- Velcro Mount
- PC Interface Cable



INTRODUCTION

Cautions



CAUTION: The Global Positioning System (GPS) is operated by the government of the United States, which is solely responsible for its accuracy and maintenance. The system is subject to changes which could affect the accuracy and performance of all GPS equipment. Although the GPS III+ is a precision electronic NAVigation AID (NAVAID), any NAVAID can be misused or misinterpreted and, therefore, become unsafe.

WARNING: For vehicular applications, it's the sole responsibility of the owner/operator of the GPS III+ to secure the GPS unit so that it will not cause damage or personal injury in the event of an accident. Do not mount the GPS III+ over airbag panels or in a place where the driver or passengers are likely to have an impact with it in an accident or collision. The mounting hardware provided by GARMIN is not warranted against collision damage or the consequences thereof.

WARNING: For vehicular operations, it is the sole responsibility of the operator of the vehicle to operate his or her vehicle in a safe manner, maintain full surveillance of all driving conditions at all times, and never become distracted by the GPS III+ to the exclusion of safe operating practices. It is unsafe to operate the GPS III+ while you are driving. Failure by the operator of a vehicle equipped with a GPS III+ to pay full attention to operating the vehicle and road conditions while the vehicle is in motion could result in an accident or collision with property damage and personal injury.

MAP DATA INFORMATION: One of the goals of GARMIN is to provide customers with the most complete and accurate cartography that is available to us at a reasonable cost. We use a combination of governmental and private data sources, which we identify as required in product literature and copyright messages displayed to the consumer. Virtually all data sources contain inaccurate or incomplete data to some degree. This is particularly true outside the United States, where complete and accurate digital data is either not available or prohibitively expensive.

This device complies with Part 15 of the FCC limits for Class B digital devices. This equipment generates, uses, and can radiate radio frequency energy and, if not installed and used in accordance with the instructions, may cause harmful interference to radio communications. Furthermore, there is no guarantee that interference will not occur in a particular installation.

If this equipment does cause harmful interference to other equipment, which can be determined by turning the affected equipment off and on, the user is encouraged to try and correct the interference by relocating the equipment or connecting the equipment to a different circuit than the affected equipment. Consult an authorized dealer or other qualified service technician for additional help if these remedies do not correct the problem.

Operation of this device is subject to the following conditions: (1) This device may not cause harmful interference, and (2) this device must accept any interference received, including interference that may cause undesired operation.

The GPS III+ does not contain any user-serviceable parts. Repairs should only be made by an authorized GARMIN service center. Unauthorized repairs or modifications could void your warranty and authority to operate this device under Part 15 regulations.



INTRODUCTION

Limited Warranty

GARMIN Corporation warrants this product to be free from defects in materials and workmanship for one year from the date of purchase. GARMIN will, at its sole option, repair or replace any components which fail in normal use. Such repairs or replacement will be made at no charge to the customer for parts or labor. The customer is, however, responsible for any transportation costs. This warranty does not cover failures due to abuse, misuse, accident or unauthorized alteration or repairs.

THE WARRANTIES AND REMEDIES CONTAINED HEREIN ARE EXCLUSIVE AND IN LIEU OF ALL OTHER WARRANTIES EXPRESSED OR IMPLIED, INCLUDING ANY LIABILITY ARISING UNDER WARRANTY OF MERCHANTABILITY OR FITNESS FOR A PARTICULAR PURPOSE, STATUTORY OR OTHERWISE. THIS WARRANTY GIVES YOU SPECIFIC LEGAL RIGHTS, WHICH MAY VARY FROM STATE TO STATE.

IN NO EVENT SHALL GARMIN BE LIABLE FOR ANY INCIDENTAL, SPECIAL, INDIRECT OR CONSEQUENTIAL DAMAGES, WHETHER RESULTING FROM THE USE, MISUSE OR INABILITY TO USE THIS PRODUCT OR FROM DEFECTS IN THE PRODUCT. SOME STATES DO NOT ALLOW THE EXCLUSIONS OF INCIDENTAL OR CONSEQUENTIAL DAMAGES, SO THE ABOVE LIMITATIONS MAY NOT APPLY TO YOU.

To obtain warranty service, call the GARMIN Customer Service department (913-397-8200) for a returned merchandise tracking number. The unit should be securely packaged with the tracking number clearly marked on the outside of the package, and sent freight prepaid and insured to a GARMIN warranty service station. A copy of the original sales receipt is required as the proof of purchase for warranty repairs. GARMIN retains the exclusive right to repair or replace the unit or software or offer a full refund of the purchase price at its sole discretion. SUCH REMEDY SHALL BE YOUR SOLE AND EXCLUSIVE REMEDY FOR ANY BREACH OF WARRANTY.

Customer Service Product Registration

Help us better support you by completing our on-line registration today! Have the serial number of your GPS III+ handy and connect to our web site (www.garmin.com). Look for the Product Registration link on the Home page. You can also find current user's manuals, updated unit operating software, FAQs and more on the Support page. Also, be sure to record your serial number in the area provided below.

NOTE: If you have previously registered a GARMIN product purchase using a mail-in registration card, we invite you to re-register using our on-line system. Many services provided by our new product registration system are now being automated and re-registering your purchase ensures you the best possible support from GARMIN.

Why should you register your GARMIN GPS unit:

- Notification of Product Updates
- Notification of New Products
- Lost or Stolen unit tracking

Serial Number

Use this area to record the serial number (8-digit number located on the back of the unit) in case it is lost, stolen, or needs service. Be sure to keep your original sales receipt in a safe place or attach a photocopy inside the manual.

Serial Number:

--	--	--	--	--	--	--	--

INTRODUCTION

Table of Contents

INTRODUCTION

About This Manual	i
Cautions	ii
FCC Compliance	iii
Limited Warranty	iv

GETTING STARTED

Unit Features	1
Keypad Usage / Display	2
Battery Installation	3
What is GPS?	4
Initialization	5
Main Page Sequence	7
Satellite Status Page	8
Position Page	9
Map Page	10
Compass Page	11
Highway Page	12
Main Menu	13

Marking Waypoint Positions	14
Going to a Waypoint	15
Active Route Page	16

SIMULATOR TOUR17

REFERENCE

Satellite Status Page	25
Satellite Status Page Options	29
Position Page	30
Position Page Options	31
Map Page	33
Highway Exits	35
Map Page Options	36
Compass Page	43
Compass Page Options	44
Highway Page	45
Highway Page Options	46
Waypoints	47
Waypoint Options	52

Nearest Waypoints	53
GOTO	55
GOTO Options	56
MOB	57
TracBack	58
Routes	59
Route Options	65
Active Route Page	66
Active Route Page Options	67
Main Menu	69
Setup Menu	74
APPENDIX A: Dashboard Mounting	86
APPENDIX B: Specifications	87
APPENDIX C: Wiring/Interfacing	88
APPENDIX D: Antenna/Remote Mounting	89
APPENDIX E: Messages	90
APPENDIX F: Map Datums	92
APPENDIX G: Navigation Terms	95
APPENDIX H: Time Offsets	97
APPENDIX I: Index	98

INTRODUCTION

"How To" Index

This list is provided to help you quickly find some of the more important procedures you will use on your new GPS III+.

TO DO THIS:

SEE PAGE(S):

Turn the unit on or off.....	5
Initialize the GPS receiver (first time use)	5
Adjust screen contrast or backlighting.....	25
Enter data and select options	2
Learn how to operate the unit's function keys.....	2
Mark your present location as a waypoint.....	14,22
Goto a destination.....	15,55
Create and use a route	60
Learn about the map page	10,33
Pan using the map arrow	20,34
Zoom in or out on the Map page	10,33
Reconfigure the Map Page display.....	36
Access the Main Menu	69
Change units of measure (statute, nautical, metric)	78
Change the displayed time (zone).....	80
Set alarms	81
See current position, date and time.....	9,20
View a unit message.....	90

GETTING STARTED

Unit Features

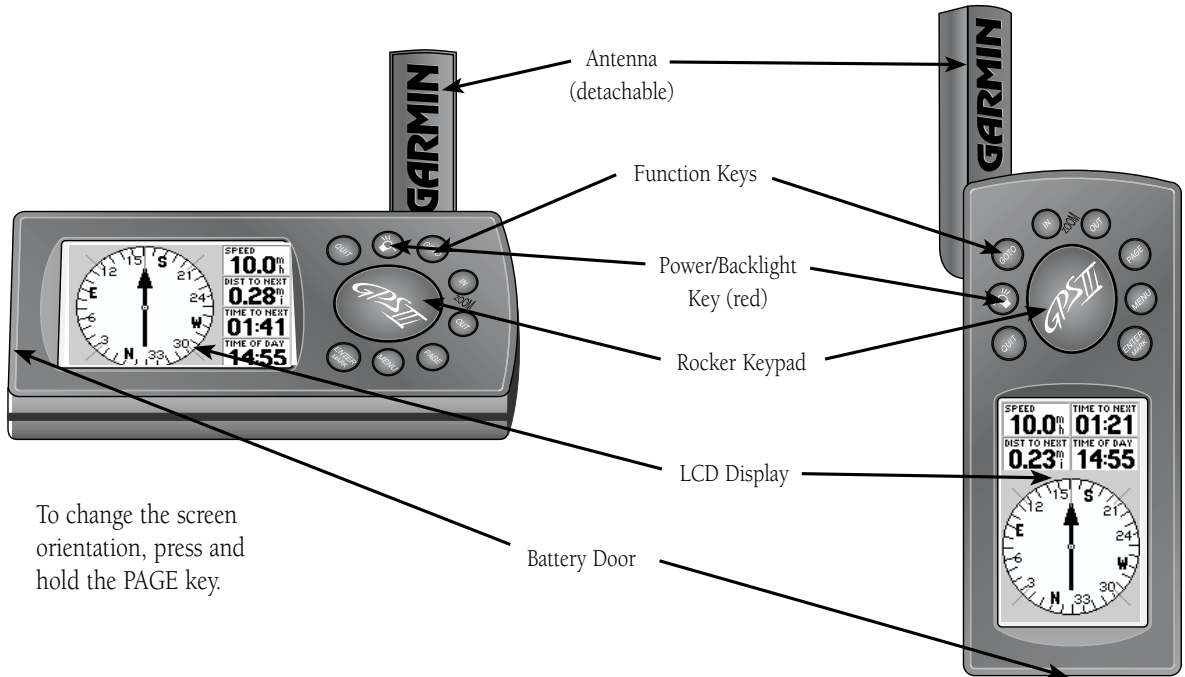

GETTING STARTED

Keypad Usage / Display



(POWER)— Red key turns the unit on and off, and controls three levels of screen backlighting intensity.



(PAGE)— Scrolls main pages in sequence and returns display from a menu/options page to a main page. Press and hold this key to change screen orientation.



(MENU)— Displays a menu of available options for the current page. Press twice to display the Main Menu.



(GOTO)— Displays the GOTO waypoint window, allowing you to select the destination waypoint. Press and hold this key to activate MOB feature.



(ENTER/MARK)— Activates highlighted fields and confirms menu options and data entry. Press and hold this key to mark present position as a waypoint.



(QUIT)— Returns the display to a previous page or restores a data field's previous value.



(IN and OUT)— Allows you to zoom in/out through 24 scales on the Map Page. Also adjusts scale on the Highway Page.



(ROCKER KEYPAD)— Controls the movement of the cursor, is used to select options and positions, and to enter data.

N 28°28.327'
W082°42.401'



N 28°28.328'
W082°42.401'

Pressing UP or DOWN on the ROCKER KEYPAD changes numbers and letters.

N 28°28.328'
W082°42.401'



N 28°28.328'
W082°42.401'

Pressing LEFT or RIGHT on the ROCKER KEYPAD moves the cursor along the line or to the next line.

DATA ENTRY— Entering data, such as waypoint names, typically begins and ends with the ENTER/MARK key. Use the rocker keypad to enter the actual data: UP/DOWN to change the highlighted character, RIGHT to move on to the next character.

CURSOR— A solid black bar which can be moved up, down, left, and right with the keypad to select individual fields on the display.

FIELD— The location on a page where a group of characters or option is entered and displayed.

HIGHLIGHT— The act of using the cursor to select a field for the purpose of entering data.

SCROLL— The act of moving through characters or options from a selected field.

DEFAULT— A system-selected format, built into the operating software or the unit's memory, that will be followed unless the user chooses a different setting.

The GPS III+ operates on 4 AA batteries (not included), which are installed at the base of the unit. These batteries provide up to 36 hours of continuous use (See page 87). Rechargeable NiCad or lithium batteries may also be used.



NOTE: The on-screen battery level indicator is calibrated for alkaline batteries, and will not be accurate when using NiCad or lithium batteries (see page 77).

To install the batteries:

1. Flip up the metal ring at the base of the unit, and turn the ring 90° counterclockwise.
2. Install the batteries and close the battery compartment door. When replacing the GPS III+'s batteries, observe the polarity markings engraved in the plastic case.
3. Lock the door in the closed position by rotating the metal ring 90° clockwise.

Battery life varies due to a variety of factors, including temperature, use of an external antenna, and backlighting. You may find that the battery life varies in different conditions and that lithium batteries provide longer life in colder conditions. An internal 10-year lithium battery will retain your data while you're changing batteries.

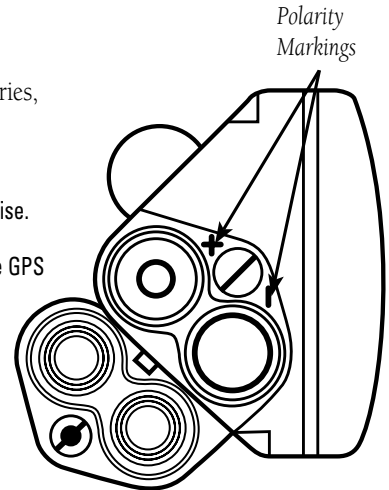

GETTING STARTED

What is GPS?

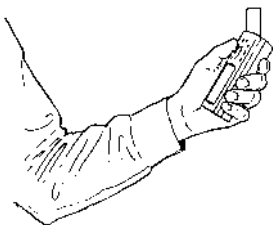

Hold the receiver at a comfortable height with the antenna pointing up.



When new (or if a position cannot be determined after 10 minutes), the GPS III+ will prompt you to initialize the receiver. The unit needs a starting position to determine which satellites are in view.

The Global Positioning System (GPS) is a system of 24 satellites which circle the earth twice a day in a very precise orbit and transmit information to earth. The GPS III+ must continuously “see” at least three of these satellites to calculate your position and track your movement. At times, additional satellites may be needed to determine a position. Visit the GARMIN web site for more information on GPS.

By using an almanac (a timetable of satellite numbers and their orbits) stored in the receiver’s memory, the GPS III+ can determine the distance and position of any GPS satellite and use this information to compute your position.

Your GPS receiver can only see satellites above the horizon, so it needs to know what satellites to look for at any given time. To use this almanac data, your GPS needs to either be told its general location (“initialized”) or given the opportunity to find itself. Once you initialize the unit to a position, it will typically compute a fix within a few minutes. We’ll show you how to initialize your new GPS III+ on page 5.

Initialization is only necessary under the following conditions:

- The first time you use your receiver (new from the factory).
- After the receiver has been moved over 500 miles (with the power off) from the last time you used it.
- If the receiver’s memory has been cleared and all internally stored data has been lost.

Because the GPS III+ relies on satellite signals to provide you with navigation guidance, the receiver needs to have an unobstructed, clear view of the sky for best performance. In a nutshell, the GPS receiver’s view of the sky will generally determine how fast you get a position fix—or if you get a fix at all. GPS signals are relatively weak and do not travel through rocks, buildings, people, or metal, so remember to keep a clear view of the sky at all times for best performance.

Once the GPS III+ has calculated a position fix, you'll usually have anywhere from five to twelve satellites in view. The receiver will then continuously select the best satellites in view to update your position. If some of the satellites in view get blocked or "shaded," the receiver can simply use an alternate satellite to maintain the position fix. Although a GPS receiver needs four satellites to provide a three-dimensional (3D) fix, it can maintain a two-dimensional (2D) fix with only three satellites. A three-dimensional fix means the unit knows its latitude, longitude, and altitude, while a two-dimensional fix means the unit knows only its latitude and longitude.

Initializing Your GPS III+

To initialize the GPS III+, take the receiver outside and find an open area where the antenna has a clear view of the sky. You may either hold the receiver at a comfortable height with the antenna pointing up (see page 4), or mount the receiver on the dash of a vehicle (Appendix A) or on a bike. (Likewise, when you use your GPS III+ in a vehicle, make sure the antenna is pointing up.)

To turn the GPS III+ on, press and hold the red power key.

The Welcome Page will be displayed while the unit conducts a self test. Once testing is complete, the Welcome Page will be replaced by a warning page, then by the Satellite Status Page. A message will inform you to "select initialization method". (If the initialization prompt has not automatically appeared, press MENU and highlight 'Initialize Position' and press ENTER.)

To initialize your unit:

1. Press ENTER to acknowledge the message and see a list of initialization options.
2. Use the rocker keypad to highlight 'Use Map', and press ENTER.
3. Use the rocker keypad to point the map cursor to your approximate location (within 250 miles). You may also wish to use the IN and OUT zoom keys to make it easier to identify your approximate position.
4. Press ENTER to select the position and begin searching for satellites.

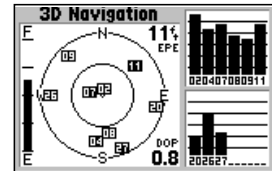

Check the Satellite Status Page for '2D Navigation' or '3D Navigation' to verify a position fix.



To initialize the GPS III+, designate your approximate location directly on the map display. Use the rocker keypad and IN/OUT zoom keys to position the cursor on the map.

GETTING STARTED

Initialization

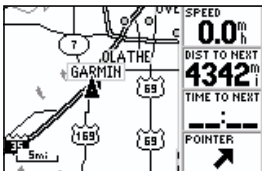

Once the GPS III+ has a position fix, it will automatically transition from the Satellite Status Page to the Map Page.



If powering the III+ with external power, and the external power is lost, the unit will automatically turn off after 30 seconds.

This usually provides a position fix in 1 minute. You'll know you have a fix when the unit automatically transitions from the Satellite Page to the Map Page, unless you have manually changed pages (shown left). Your receiver is now ready to use!

To turn the unit off:

1. Press and hold the red power key for 1 second.

Troubleshooting

If you have trouble initializing or getting a position fix, check the following:

• Does the receiver have a clear view of the sky?

If there are large buildings or mountains, or if there is heavy tree cover, the receiver may not be receiving enough satellite signals to calculate a fix. Also, if you're using the GPS III+ on a car dash, make sure the unit is placed so that it has the clearest possible view of the sky. Your GPS will only be able to detect satellites that it can "see" through your vehicle's windshield. Depending on the slope of your dash or the overall surface area of the window, it may be necessary to mount an external antenna on your vehicle's roof or trunk in order to give the unit a better view of the sky. (Contact your local GARMIN dealer or GARMIN Sales and inquire about the GA 26C low-profile remote antenna, part number 010-10052-04.)

• Have you selected the right area when initializing?

Check for the correct approximate position on the Map Page (press PAGE until the Map Page appears; see pages 7 and 10), or reselect your approximate location to restart the initialization.

• Have you moved more than 500 miles from the last calculated position with the receiver off?

Reinitialize the receiver by selecting your approximate position on the map, or select 'AutoLocate' from the Satellite Status Page options (see page 29).

GETTING STARTED

Main Page Sequence

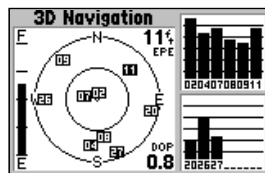

Satellite Status Page

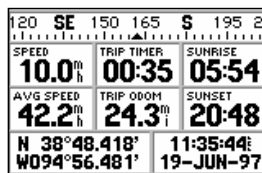

Position Page

PAGE

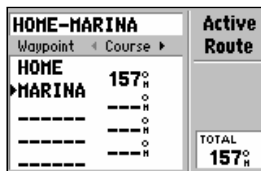

Active Route Page

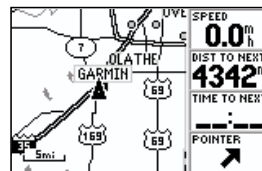
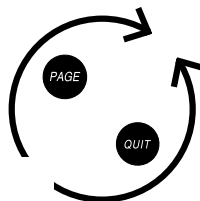

Map Page

Press the PAGE key to move through each of the main pages in normal fashion.

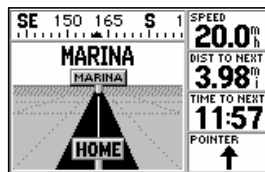

Highway Page

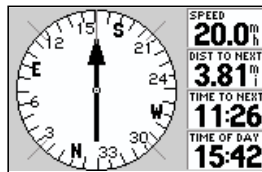

Compass Page

QUIT

To turn the GPS III+ back on, press and hold the red power key.

The GPS III+ features six main pages which are linked together in a chain. You can quickly scroll through the pages in either direction using the PAGE or QUIT keys. Let's briefly tour each of these pages in order to give you some insight into how they help you navigate. We'll go over all of them in more detail in the reference section.

Press the QUIT key to sequence through the main pages in reverse order.

GETTING STARTED

Satellite Status Page

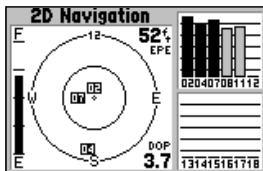

The signal strength bars give you an indication of what satellites are visible to the receiver, whether or not they're being used to calculate a position fix, and the signal quality.

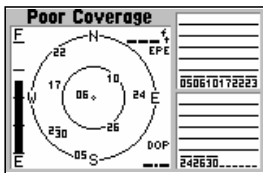

If satellite reception is lost, or an insufficient number of satellites are available, you will be alerted with a 'Poor Coverage' receiver status and message.

Let's start with the Satellite Status Page, which is the page you'll view while your unit is getting a position fix. If you're not already on this page, press PAGE or QUIT until it appears. The Satellite Status Page shows you status information that helps you understand what the receiver is doing at any given time, and it's a page that you'll want to occasionally refer back to as you use your unit. It features a sky view of available satellites, corresponding signal strength bars, the status of your current position fix (acquiring, 2D, 3D, etc.), and your estimated position error (EPE). You can also tell how much battery power is remaining, and you can adjust the screen contrast/backlighting by pressing the rocker keypad.

Satellites are indicated on the sky view and the signal strength bars by their corresponding number, from 01 through 32. The sky view shows where it is looking in the sky for each satellite, by indicating the direction and elevation (angle above the horizon). The signal strength bars depict the relative strength of the signal from each satellite being received. The taller the bar, the stronger the signal.

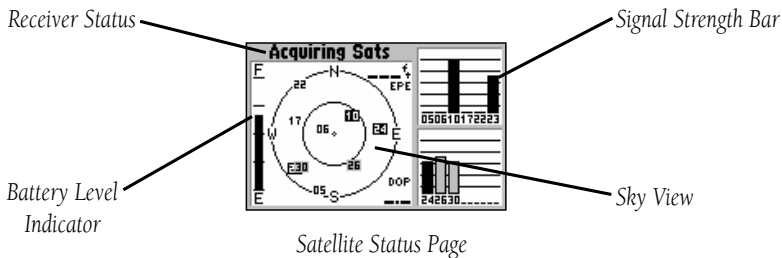

Satellite Status Page

GETTING STARTED

Position Page

The Position Page shows you where you are, what direction you're heading, and how fast you're going—and it's the page you'll want to use when you don't have a destination selected.

A graphic compass display at the top of the page shows your direction of travel (track) while you're moving, while six user-selectable data fields below display your current speed, average speed, trip odometer, trip timer, and sunrise/sunset times at your current position. "User-selectable" means you can change them to display other information. We'll cover these fields more in the reference section.

Below the user-selectable data fields are additional data fields to display your current position, along with current time and date. The current position readout can be in latitude/longitude, UTM/UPS, Loran TD, MGRS, Maidenhead or one of several regional grids. Current time and date can be in local time or UTC (Coordinated Universal Time).

NW 330 345 N 015 030		
SPEED 0.0 ^m / _h	TRIP TIMER 01:28	SUNRISE 05:56
AVG SPEED 44.4 ^m / _h	TRIP ODOM 65.0 ^m / _i	SUNSET 20:49
15 S 033143Z		14:11:23 ⁱ
UTM 4297146		25-JUN-97

Position Page showing UTM coordinates for use with USGS topographic maps, etc.

Track Compass

Current Position Coordinates

120 SE 150 165 S 195 2		
SPEED 10.0 ^m / _h	TRIP TIMER 00:35	SUNRISE 05:54
AVG SPEED 42.2 ^m / _h	TRIP ODOM 24.3 ^m / _i	SUNSET 20:48
N 38°48.418'		11:35:44 ⁱ
W094°56.481'		19-JUN-97

Trip Odometer

Current Time and Date

Position Page



The trip odometer, trip timer and average speed readings can all be reset from the 'Trip Computer' option on the Main Menu. See page 74.

GETTING STARTED

Map Page

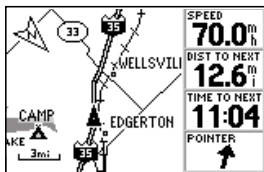

With the map oriented to 'track up', the pointer always points up and the map rotates to your current direction of travel (track). Note the north indicator on the map.

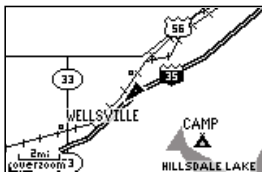

You can also select a full-screen map from the Map Page Options. See page 37.

The Map Page shows your movement using a real-time track log (an electronic breadcrumb trail that appears directly on the map as you're traveling), and your present position as a pointer icon in the center of the map. The Map Page also shows any nearby lakes, rivers, highways and towns. Use the zoom keys (IN and OUT) to adjust the map to the desired scale.

To change the map scale:

1. Press the IN zoom key to select a smaller scale and more detail for a smaller area.
2. Press the OUT zoom key to select a larger scale and display a larger area.

The map can be oriented with the top of the page always pointing north, oriented along your desired course, or it can automatically rotate to keep your current direction of travel (track) at the top of the screen. The default setting is 'North Up', which keeps the top of the page always pointing north.

Nearby waypoints are depicted on the map with any one of over 70 different symbols, with the waypoint name shown directly above the symbol. We'll cover more about the GPS III+'s waypoint features and the Map Page in the reference section of this manual.

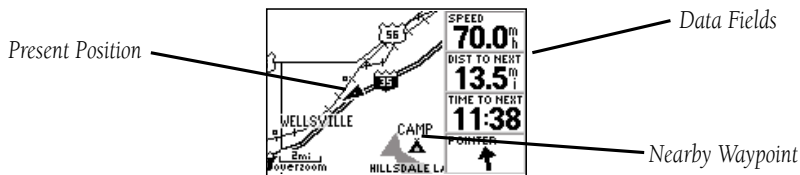

Map Page

GETTING STARTED

Compass Page

The GPS III+ features two different navigation pages: Compass and Highway. The Compass Page is first. This page provides graphic steering guidance to a destination waypoint, with an emphasis on the bearing to your destination and current direction of travel. (The Highway Page places greater emphasis on the straight-line desired course and the distance and direction you are off course.) The middle of the page features a rotating 'compass ring' that shows your course over ground (track) while you're moving, and a bearing pointer that indicates the direction of the destination (bearing) relative to the course over ground. The compass ring and pointer arrow work independently to show—at a glance—the direction of your movement and the direction to your destination. For instance, if the arrow points up, you are going directly to the waypoint. If the arrow points any direction other than up, turn toward the arrow until it points up—then continue in that direction.

The current speed and distance to the destination waypoint are displayed at the top of the screen. The bottom of the page displays the time to the destination waypoint and the current time. This page provides better steering guidance than the Highway Page when travelling at slower speeds and/or when making frequent directional changes.

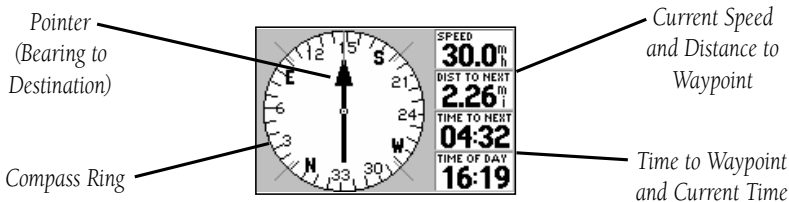

Compass Page

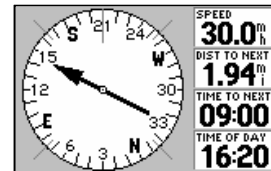

If the bearing pointer points up, you are going directly to your destination. If not, turn toward the arrow until it points up, then continue in that direction.

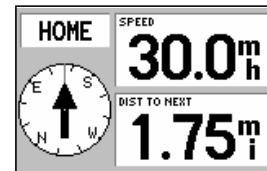

The 'Big Numbers' option (available from the Compass Page Options) shows a much smaller compass display and larger data field characters. See page 44.

GETTING STARTED

Highway Page

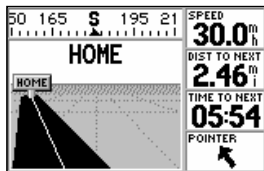

If you move off course the highway display will move, indicating the direction you are off course. To stay on course, simply move toward the center of the highway.

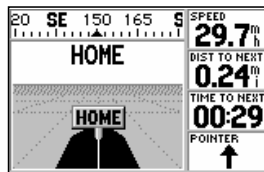

As you approach your destination, the graphic highway will stop at the destination waypoint. You have arrived when the waypoint is at the bottom center of the display.

The GPS III+'s Highway Page also provides graphic steering guidance to a destination waypoint. As you head toward your destination, the middle of the screen provides visual guidance to your waypoint on a moving graphic "highway." Your present position is at the bottom center of the highway display. The line down the middle of the highway represents your desired course. As you navigate toward a waypoint, the highway will actually move—indicating the direction you're off course. To stay on course, simply move toward the center of the highway.

The top of the page indicates speed and distance to your destination (or the next waypoint in a route), along with a track compass showing current direction of travel. Directly below the distance reading is the time required to reach your destination (or the next waypoint in a route), in hours/minutes or minutes/seconds. The pointer at the bottom of the page also shows the bearing to your destination, relative to your current track. If the pointer points straight ahead, you're heading directly to your destination!

Use the Highway Page as your primary navigation page (in lieu of the Compass Page) when your main concern is following a defined course.

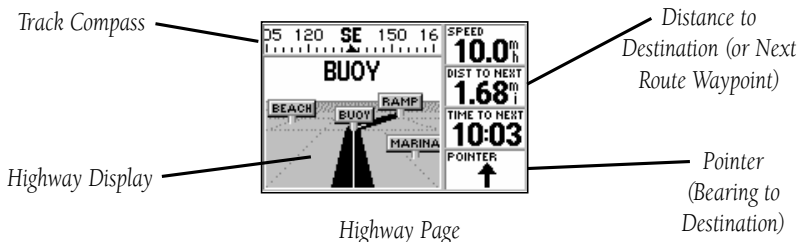

The GPS III+'s Main Menu provides access to additional pages (submenus) that are used to create or edit waypoints, create routes, list nearby waypoints, review trip information and timers or make changes to system settings. These six pages are divided into categories by function. The waypoint and route management features of the Main Menu are described in more detail in the Reference section of this manual. Let's take a quick look at the Main Menu and one of its submenu items.

To view the Main Menu:

1. Press the MENU key twice.

To select a submenu item from the Main Menu:

1. Highlight the desired item using the rocker keypad, and press ENTER.
2. To return to the Main Menu, press QUIT.

The 'Setup' option provides a list of choices (presented as a series of 'file tabs') to perform various configuration settings including system settings, selection of position format and units of measure, time display, setting various alarms, enabling the built-in simulator feature and interface options with other equipment:

To change units of measure for distance and speed:

1. Select the 'Setup' option from the Main Menu (as described above), and press ENTER.
2. Highlight the 'Units' tab with the rocker keypad. The units settings are automatically displayed.
3. Highlight the 'Distance & Speed' field using the rocker keypad, and press ENTER. A pop-up menu appears showing the available options.
4. Select the desired option using the rocker keypad, and press ENTER.

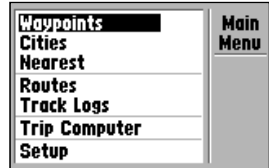

The Main Menu provides access to seven additional (submenu) pages.

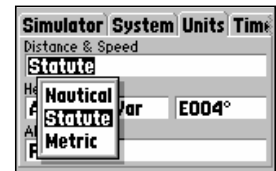

The 'Setup' option provides a list of menu choices to perform various configuration settings, such as changing units of measure for distance and speed.

GETTING STARTED

Marking Waypoint Positions

Mark Waypoint	
■ HOM ---	Done
Comment	Reference
CRTD 17:32	-----
11-JAN-01	Bearing
Position	000?
N 38°51.335'	Distance
W094°47.930'	0?

Each waypoint stored in memory is identified by a unique name, up to six characters long (letters and/or numbers).

Waypoint Symbol	
Com	Residence
CR	Y1 Restaurant
Pos	RV Restroom
N	RV Park
HC	Scales

Each waypoint may also be assigned a custom waypoint symbol, making it easy to identify the waypoint on the Map Page.

GPS is really about marking and going to places called 'waypoints'. Before we can use the GPS III+ to guide us somewhere, we have to mark a position as a waypoint. Your GPS III+ can hold up to 500 waypoints.

To mark your present position:

1. Press and hold the ENTER/MARK key. The Mark Waypoint Page will appear, with a default three-digit name for the new waypoint in the upper-left portion of the page.

To rename the waypoint:

1. Use the keypad to highlight the name field, and press ENTER.
2. Enter the new waypoint name using the rocker keypad, and press ENTER.

Each waypoint may also be assigned a custom waypoint symbol for easy waypoint recognition on the Map Page.

To change the waypoint symbol:

1. Highlight the waypoint symbol field (immediately to the left of the waypoint name field) and press ENTER.
2. Select the desired symbol, and press ENTER.
3. Move the cursor to the 'DONE?' prompt, and press ENTER.

The Mark Position Page will be replaced with the page displayed before you pressed ENTER/MARK to mark your position. The new waypoint is now stored in the GPS III+'s memory.

GETTING STARTED

Going to a Waypoint

Once you've stored a waypoint in memory, you can use the GPS III+ to guide you to it by using the GOTO feature. A GOTO is really nothing more than a straight-line course from your present position to the destination you've selected. A GOTO can be performed several ways: by specifying the destination from the GOTO Page, graphically from the map display or by highlighting the waypoint name on any page (such as from one the 'Nearest' lists).

To select a GOTO destination from the GOTO Page:

1. Press GOTO. This captures your current position as the starting point for your trip.
2. Highlight the 'All' tab, using the rocker keypad, to list all waypoints currently stored in memory.
3. Highlight the desired waypoint, using the rocker keypad, and press ENTER.

To select a GOTO destination from the Map Page:

1. With the Map Page displayed, use the rocker keypad to place the cursor over the desired destination waypoint. (If no waypoint exists at the destination location, the GPS III+ will automatically create one, named 'MAP' in the step below.)
2. Press GOTO, and then ENTER to navigate to the selected location.

To GOTO a listed point on the Nearest Waypoints, Nearest Cities, Nearest Exits, or Nearest Geo Points Lists:

1. With the Nearest Waypoints, Cities, Exits, or Geo Points tab highlighted (see pages 53 and 55), use the rocker keypad to highlight the desired point.
2. Press GOTO, and then ENTER to navigate to the selected location.

Once the GOTO destination is selected, use the Map Page, Compass Page and/or Highway Page to keep track of your progress as you head toward your destination.



To select a destination from all waypoints stored in memory, highlight the 'All' tab, then select the desired waypoint and press ENTER.

The screenshot shows a table with columns 'Waypoints', 'Cities', 'Exits', and 'Geo P'. The 'Cities' column is active, showing a list of cities with their bearings and distances. 'Lenexa' is highlighted.

City	Brg	Dist
Stanley	091°	7.1°
Overland Park	057°	7.3°
Spring Hill	193°	7.4°
Lenexa	004°	7.4°
Gardner	246°	7.6°

To GOTO one of the listed 'Nearest' cities, highlight the desired city, press GOTO and then ENTER. A new waypoint will be created using the city name. Cities with names longer than six characters will be abbreviated.

GETTING STARTED

Cancel GOTO/Active Route



To cancel the current GOTO destination, select 'Cancel GOTO' from the GOTO Options Page.

FISH-RAMP		Active Route
Waypoint	Distance	
FISH	---	
► BUOY	2.89 ^m	
RAMP	5.79 ^m	
-----	---	
-----	---	
TOTAL		5.79 ^m

Use the LEFT/RIGHT keys on the rocker keypad to select the desired data item. Available items include course, distance, fuel, and sunrise/sunset times.

To cancel the current GOTO destination, simply select another destination. If no destination is currently desired, or you want to resume a previously selected route, the GOTO operation may be cancelled from the GOTO Options Page.

To cancel the current GOTO destination:

1. Press GOTO.
2. Press MENU.
3. Highlight 'Cancel GOTO' and press ENTER.

Active Route Page

The last of the six main pages is the Active Route Page. This page shows the GOTO waypoint or each waypoint of a route, with waypoint name and the course along each leg (segment) of the route. When using a route, the current destination is marked with an arrow on the left-hand side of the screen. If no destination has been specified using the GOTO key or a route, no waypoints will be listed on the page. (For more information on using routes, see page 60 in the Reference section.)

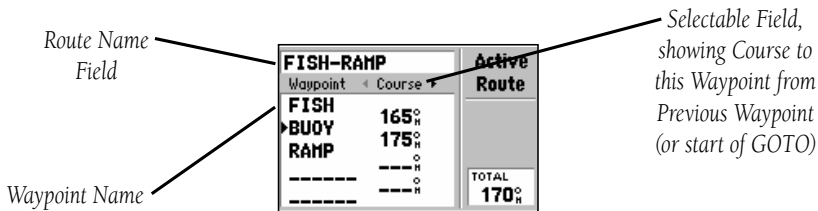

Active Route Page

The GPS III+ is a powerful navigation system providing detailed mapping information in a convenient, compact package. This simulator tour is designed to show you the basic features of your new GPS III+ during a simulated trip. The simulator tour assumes that the receiver has been properly initialized as outlined in the Getting Started section of this manual, and that you have not changed any of the factory default settings. If you have changed any settings (position formats, units of measure, etc.), the descriptions and pictures in the tour may not match your configuration.

Once you're familiar with the primary functions of the GPS III+, you'll be ready to use your new receiver on a real trip to a destination of your choice. The Reference section of this manual may be consulted for any additional questions you may have, or to learn about the more advanced features of the GPS III+. For now, let's get started on the Simulator Tour!

If the GPS III+ is currently off, we'll need to start by turning it on.

To turn the GPS III+ on, press and hold the red power key.

The Welcome Page will be displayed while the unit conducts a self test. Once testing is complete, the Welcome Page is replaced by a warning page, then by the Satellite Status Page. Since we'll be using the simulator mode, we don't need to wait for the receiver to acquire satellites.



WARNING: Keep in mind that the GPS III+ does not track satellites in simulator mode and should never be used for actual navigation. The GPS III+ cannot be turned on in simulator mode. If you forget to change back to normal operation before shutting the receiver off, it will automatically return to normal mode the next time you use the receiver.



The Welcome Page is displayed when the GPS III+ is first turned on. After a brief self-test, it is replaced by a warning page for about 10 seconds. To acknowledge this page, press ENTER.

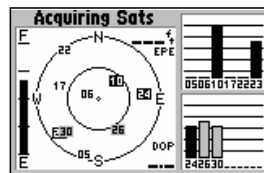

The Satellite Status Page appears next. For simulator mode operations, there's no need to wait for the GPS III+ to acquire satellites.

SIMULATOR TOUR

Selecting Simulator Mode



Select 'Start Simulator' from the Satellite Status Page Options to enable the built-in simulator.

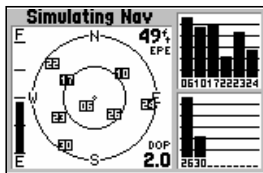

The simulator imitates satellite reception and shows that information on the Satellite Status Page. Remember, in this mode the GPS III+ is **not** actually tracking satellites.

To select the simulator mode:

1. Press MENU to list the options for the Satellite Status Page.
2. Highlight 'Start Simulator' with the rocker keypad, and press ENTER.
3. Press ENTER again to acknowledge the simulator warning message.

Let's look at the sequence of pages again. The PAGE and QUIT keys are used to find your way around on the GPS III+.

To cycle through the main pages:

1. Press PAGE to move through each of the main pages in normal fashion.
2. Press QUIT to sequence through the main pages in reverse order.

In normal mode operation, the GPS III+ would automatically sequence from Satellite Status Page to Map Page once enough satellites were received to determine your position. At that point the receiver is ready to use for navigation. Since we're in simulator we won't see that automatic sequence of steps, but as you cycle through the main pages, notice that the simulator imitates satellite reception and shows that information on the Satellite Status Page.

The Position Page will show the last known position as a starting location. If you've already initialized the receiver, as outlined in the Getting Started section, the starting location should be very close to your current position! We'll use this starting location from which to begin our simulated trip. Let's move on to the Map Page to see where we are, create a destination and explore the navigation features of the GPS III+.

SIMULATOR TOUR

Using the Map Page

To select the Map Page, press PAGE repeatedly until it appears.

The GPS III+'s Map Page combines digital charting with a number of user-selectable features. Before we select our destination and begin navigating toward it, let's take a look at some of those features.

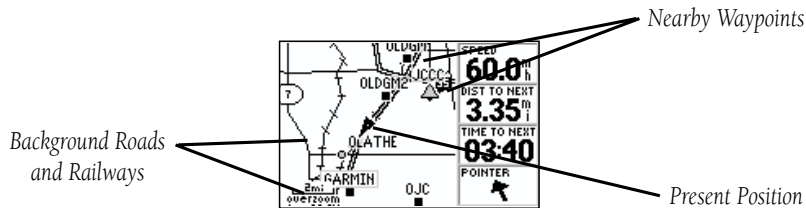

The map display shows your present position using a pointer icon in the center of the screen. The Map Page also shows any nearby lakes, rivers, highways and towns. Use the zoom keys (IN and OUT) to adjust the map to the desired scale. The current scale is indicated in the lower-left corner.

To change the map scale:

1. Press the IN zoom key to select a smaller scale and display a smaller geographic area.
2. Press the OUT zoom key to select a larger scale and display a larger geographic area.

The map can be oriented with the top of the page always pointing north ('North Up'), oriented along your desired course ('Course Up'), or it can automatically rotate to keep your current direction of travel at the top of the screen ('Track Up').

Nearby waypoints are depicted on the map with any one of over 70 different symbols, with the waypoint name displayed directly above the symbol. Let's create a waypoint directly on the map display to see how that process works, then we'll navigate to this new waypoint.

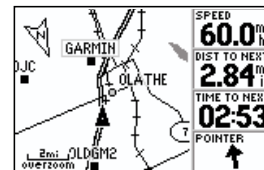

In the 'Track Up' orientation, the map is automatically rotated to keep your current direction of travel at the top of the screen. Note the north indicator in upper-left corner.

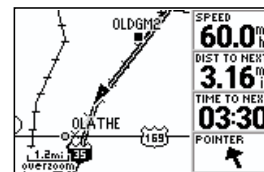

Use the IN/OUT zoom keys to change the map scale. The current scale appears in the lower-left corner of the map display.

SIMULATOR TOUR

Creating a Waypoint

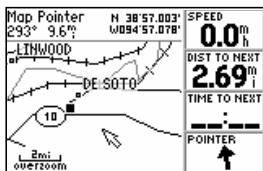

Use the rocker keypad to pan to other areas on the map display. When panning an on-screen arrow appears for reference, along with a data field above the map.

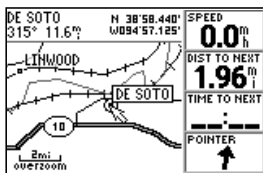

Place the panning arrow over an on-screen item to display a descriptive name.

Select a five mile scale by pressing zoom IN or OUT repeatedly.

Working from the Map Page is a simple process that centers around the use of a reference “arrow”. Controlled by the rocker keypad, the reference arrow is an important tool allowing you to pan to other areas on the map display, create waypoints, view waypoint information and create routes. To get a feel for using the Map Page and the arrow, try the following exercise:

1. Using the rocker keypad to move the arrow, try following a highway (or other feature) near your position. Simply press and hold one side of the rocker keypad to move more quickly. Notice how a data field appears above the map, showing the bearing and distance from present position to the cursor, along with the latitude/longitude of the arrow's position.
2. Using the rocker keypad, move the arrow in any direction until you find a nearby city or town. Once you find a nearby city or town, place the pointer on it to highlight the location. Now, press ENTER to create a waypoint at the arrow location and display the New Map Waypoint Page.

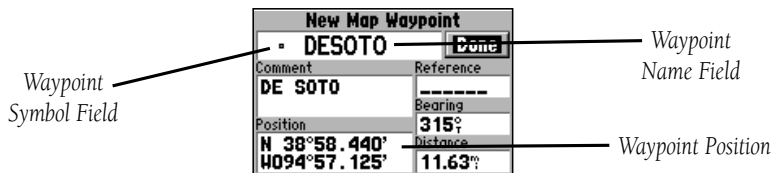

3. If the name of the city or town is longer than six characters, the GPS III+ will abbreviate the name when it creates the waypoint. (If you select an open location on the map, where no city, town or other feature is located, a three-digit number is pre-assigned to the new waypoint created at the panning arrow location. To change the name, highlight the waypoint name field, press ENTER and use the rocker keypad to enter a new name – UP/DOWN to change the first character, RIGHT to move to the next character, and repeat. Once the new name is spelled out, press ENTER.)

4. A city symbol is assigned to the new waypoint, but let's use a special symbol to identify it. Highlight the waypoint symbol field, using the rocker keypad, and press ENTER. Use UP/DOWN on the rocker keypad to select the 'Information' icon (?) and press ENTER.

5. To save the new waypoint, highlight 'Done' with the rocker keypad and press ENTER.

Now that we've created our new waypoint (also see pg. 47), let's see how the GPS III+ is used to navigate to it. The reference arrow can also be used to GOTO any point on the map—even without a waypoint already at that location—by simply pressing GOTO. (We won't try that here. A waypoint named 'MAP' is automatically created, so all the previous steps for creating and naming a waypoint wouldn't be needed. You might want to experiment with this procedure at the end of the Simulator Tour.) For the Simulator Tour, we'll stick with the waypoint we just created.

To select the GOTO destination:

1. Press GOTO.
2. If the 'All' file tab is not selected, use the rocker keypad to highlight this tab. ('All' will display a list of all waypoints currently stored in memory.)
3. Highlight the new waypoint you just created using the rocker keypad, and press ENTER.

Notice that a course line appears on the map display showing the way to our destination. Imagine you're about to depart. Maybe you're heading out from the marina or you're about to venture into the wilderness. What if you want to return to your present position when you're done for the day? You have two options available:

- You can mark your present position now and save it as a waypoint, or
- You can use the TracBack feature at the end of the day to retrace your steps – following the same path you travelled, but in reverse.

For now, we'll mark our present position and save it as a waypoint. (You might want to experiment with the TracBack feature later. It's described on page 58.)

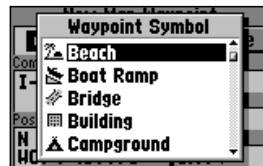

You can select a special symbol to identify the waypoint on the Map Page.



To select a GOTO destination, press GOTO and highlight the desired waypoint on the list. (You may also need to select the 'All' file tab on the GOTO Page, to see all waypoints currently in memory.)

SIMULATOR TOUR

Marking Present Position

Mark Waypoint	
001	Done
Comment	Reference
CRTD 20:32	-----
11-JAN-01	Bearing
Position	000?
N 38°51.335'	Distance
W094°47.930'	0'

To mark your present position and save it as a waypoint, press and hold ENTER. A three-digit name is automatically assigned to the waypoint.

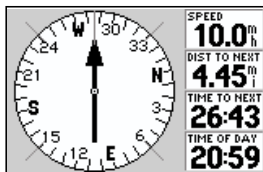

From the Compass Page you can increase/decrease the simulated speed using the UP/DOWN keys on the rocker keypad.

To mark your present position:

1. Press and hold the ENTER/MARK key. The Mark Waypoint Page will appear, with a default three-digit name for the new waypoint in the upper-left portion of the page.

Let's call our present position 'HOME'. (If you were at home when you initialized your GPS III+, you might want to keep this waypoint in memory for future use!)

To rename the waypoint and change its symbol:

1. Use the keypad to highlight the name field, and press ENTER.
2. Enter the new waypoint name ('HOME') using the rocker keypad, and press ENTER. (Remember to use UP/DOWN to change the character and RIGHT to move to the next character field.)
3. Highlight the waypoint symbol field and press ENTER.
4. Select the 'Residence' symbol, and press ENTER.
5. Move the cursor to the 'DONE?' prompt, and press ENTER.

Now we have two waypoints in memory and on the map: the city location we saved earlier and 'HOME'. It's about time we get started, so let's plug a speed into this simulator to animate the displays!

To enter a simulated speed and animate the displays:

1. Press PAGE repeatedly until the Compass Page appears.
2. Enter a simulated speed of '10' (mph or knots) using the rocker keypad. (Press UP on the rocker keypad once to select '10'. The speed readout is on the upper right corner of the Compass Page.)
3. Press PAGE (or QUIT) repeatedly to return to the Map Page.

Notice the information on the map display is slowly moving? That's how it would look in actual use as well. The background map information and nearby waypoints will move across the screen, while your current position remains fixed in the center.

The other primary navigation screens are the Compass and Highway pages, with the Compass Page appearing first in the sequence of main pages.

To view the Compass Page, press PAGE.

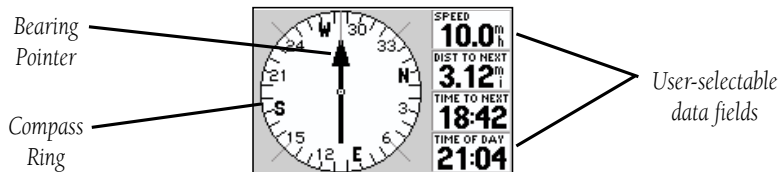

The GPS III+'s Compass Page provides graphic steering guidance to a destination waypoint. The middle of the page features a rotating 'compass ring' that shows your course over ground (track) while you're moving, and a bearing pointer that indicates the direction of the destination (bearing) relative to the course over ground. The compass ring and pointer arrow work independently to show—at a glance—the direction of your movement and the direction to your destination. If the arrow points up, you are going directly to the waypoint. If the arrow points any direction other than up, turn toward the arrow until it points up—then continue in that direction. The distance to the next waypoint, time to the next waypoint and current speed are displayed to the right of the graphic compass display. To see how all this works on our simulated trip, let's head off course and watch the displays change.

To move off course / on course in simulator mode, use the LEFT/RIGHT keys on the rocker keypad.

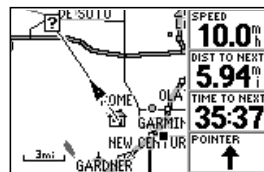

The background map moves while keeping your current position at the center of the map display.

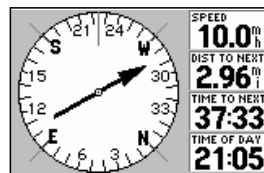

The Compass Page will also guide you to your destination. The rotating 'compass ring' shows the direction of travel (track) and the arrow points to your destination (bearing).

SIMULATOR TOUR

Highway Page

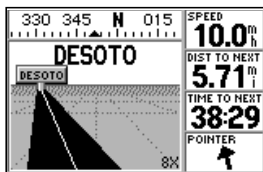

Use the LEFT/RIGHT keys on the rocker keypad to move off course / on course. To return to your course, steer toward the highway centerline.

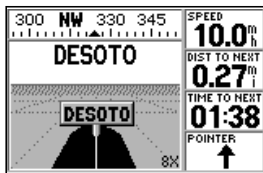

When you reach your destination, the highway will end at the waypoint marker. Also note the 'distance to next' waypoint readout. If you pass the waypoint the pointer will swing around, pointing down.

To view the Highway Page, press PAGE.

The Highway Page provides a graphic highway display that shows your movement relative to the desired course. The line down the middle of the highway represents your desired course. As you navigate toward your destination, the highway will actually move, indicating the direction you're off course. To stay on course, simply steer toward the center of the highway. As you approach the waypoint, the highway will end at the final destination. When the waypoint marker is at the bottom center of the highway display, you've arrived at your destination. A track compass also shows your current track directly above the highway display, making it easy to see at a glance which way you're headed.

The pointer arrow at the bottom of the page indicates the direction to the destination waypoint (bearing) relative to the direction you are moving (track). If the pointer points straight ahead, you're heading directly to the waypoint. If not, turn in the direction of the pointer and the pointer will swing around, pointing straight ahead as you begin moving toward the destination waypoint. Try moving on course/ off course again using the rocker keypad and watch as the highway display and bearing pointer change.

That's it! You've covered the basics and you're ready to venture off on your own. Operating the GPS III+ is just as simple as you've seen here in the Simulator Tour, but in real applications you won't need to change speed and track with the rocker keypad. That's all done automatically utilizing information from the GPS satellites as you move about.

Before ending the tour, try a few experiments of your own, such as going back to the 'HOME' waypoint, retracing your steps utilizing the TracBack feature, or creating a few more waypoints. Use the Reference section of this manual for more ideas.

REFERENCE

Satellite Status Page

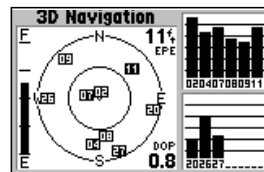

The *Satellite Status Page* shows where the satellites are and how strong the signal is from each one. A solid signal bar means the satellite is ready to use.

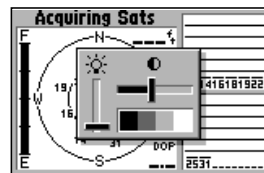

Use the *LEFT/RIGHT* keys on the rocker keypad to adjust the screen contrast and the *UP/DOWN* keys to adjust the backlighting. Press *ENTER* to save the settings.

The GPS III+'s Satellite Status Page provides a visual reference of various receiver functions, including current satellite coverage, receiver operating mode, battery level and position accuracy. As the receiver locks onto satellites, a signal strength bar will appear for each satellite in view, with the appropriate satellite number (01-32) underneath each bar. The progress of satellite acquisition is shown in three stages:

- No signal strength bars— the receiver is looking for the satellites indicated.
- Hollow signal strength bars— the receiver has found the satellite(s) and is collecting data.
- Solid signal strength bars— the receiver has collected the necessary data and the satellite(s) is ready for use.

Each satellite has a 30-second data transmission that must be collected (hollow bar status) before that satellite may be used for navigation (solid bar status). Once a fix has been calculated, the GPS III+ will then update your position, track, and speed by selecting and using the best satellites in view. You can also access the GPS III+'s backlight and contrast feature from this page.

To adjust the screen contrast and/or backlighting:

1. Press *LEFT* or *RIGHT* on the rocker keypad to adjust the level of contrast, and press *ENTER* to save the new contrast setting.
2. Press *UP* or *DOWN* on the rocker keypad to adjust the level of backlighting, and press *ENTER* to save the new backlight setting.

Sky View and Signal Strength Bars

The sky view and signal strength bars give you an indication of what satellites are visible to the receiver, whether or not they are being used to calculate a position fix, and the signal quality. The satellite sky view shows a bird's-eye view of the position of each available satellite relative to the unit's last known position. The outer circle represents the horizon (north up); the inner circle 45° above the horizon; and the center point directly overhead.

REFERENCE

Satellite Status Page

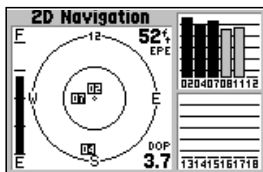

'2D Navigation' means the GPS III+ has determined a horizontal position (latitude/longitude), but is unable to determine altitude. Additional satellites may be needed.

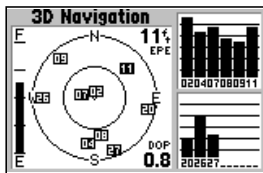

'3D Navigation' means the GPS III+ has determined a horizontal and vertical position (latitude, longitude and altitude). The receiver is ready for navigation.

You can use the sky view to help determine if any satellites are being blocked, and whether you have a current position fix (indicated by a '2D Navigation' or '3D Navigation' in the status field). You can also set the sky view to a 'Track Up' configuration, causing the top of the sky view to align along your current track heading.

When the receiver is looking for a particular satellite, the corresponding signal strength bar will be blank and the sky view indicator will not be highlighted. Once the receiver has found the satellite, a hollow signal strength bar will appear, indicating that the satellite has been found and the receiver is collecting data from it. The satellite number in the sky view will appear highlighted. As soon as the GPS III+ has collected the necessary data to calculate a fix, the status field will indicate a 2D or 3D status. (For '2D', you may need to enter your altitude. See page 29.)

Receiver Status

Receiver status is indicated at the top left of the page. The status will be shown as one of the following conditions:

Searching— the GPS III+ is looking for any available satellites in view.

AutoLocate— the GPS III+ is initializing and collecting new almanac data. This process can take up to 5 minutes, depending on the satellites currently in view.

Acquiring— the receiver is collecting data from available satellites, but has not collected enough data to calculate a position fix.

2D Navigation— at least three satellites with good geometry have been locked onto and a 2-dimensional position fix (latitude and longitude) is being calculated. '2D Diff' will appear when you are receiving DGPS corrections in 2D mode.

3D Navigation— at least four satellites with good geometry have been locked onto, and your position is now being calculated in latitude, longitude and altitude. '3D Diff' will appear when you are receiving DGPS corrections in 3D mode.

Poor GPS Coverage— the receiver isn't tracking enough satellites for a 2D or 3D fix due to bad satellite geometry.

Not Usable— the receiver is unusable, possibly due to incorrect initialization or abnormal satellite conditions. Turn the unit off and back on to reset, and reinitialize the receiver if necessary.

Simulating Nav— the receiver is in simulator mode.

'Need to Select Initialization' Prompt

If no satellites are received for several minutes (or an insufficient number of satellites are received to determine a position fix) a message will appear, prompting you to initialize the receiver (see page 5). This allows you to specify a starting location from which to search for satellites, or to enable the AutoLocate feature, and is useful if you have traveled over 500 miles with the receiver off. (This message will automatically appear when you first use your GPS III+. The prompt may also appear during normal use if the antenna is shaded or the unit is used indoors.)

Battery Level Indicator

The Satellite Status Page also features a battery level indicator, located to the left of the sky view, which displays the strength of the unit's batteries. The battery indicator will not appear if the receiver is operating on external power.



NOTE: The battery level indicator is calibrated for alkaline batteries. NiCad and lithium batteries will display the battery level differently due to voltage differences. To display battery level accurately select the appropriate type, as described on page 77. The GPS III+ features an internal 10-year lithium battery that will maintain the unit's memory when the receiver is not running off batteries or external power.

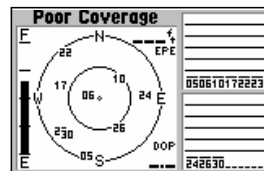

'Poor GPS Coverage' means the receiver isn't tracking enough satellites for a position fix. Check for obstructions, such as trees, buildings, etc.



This message appears if a position fix cannot be determined after several minutes. After acknowledging the message, select 'Use Map' or 'AutoLocate' from the options list.



The Satellite Status Page Options allow you to enable the built-in simulator, change the sky view orientation or initialize the receiver.



'AutoLocate' forces the receiver to search for all satellites (twelve at a time) until enough satellites are found to determine a position.

EPE and DOP

The Satellite Status Page also indicates the accuracy of the position fix, using Estimated Position Error (EPE) and Dilution of Precision (DOP) figures. DOP measures satellite geometry quality (i.e., number of satellites received and where they are relative to each other) on a scale from one to ten. The lowest numbers are the best accuracy and the highest numbers are the worst. EPE uses DOP and other factors to calculate a horizontal position error, in feet or meters.

Satellite Status Page Options

Many features of the GPS III+ are menu driven. Each of the main pages has an options menu, allowing you to custom tailor the corresponding page to your preferences and/or select special features which specifically relate to that page.

To display the Satellite Status Page Options, press MENU (with the Satellite Status Page displayed).

The following Satellite Status Page options are available:

Start Simulator— allows you to activate the GPS III+'s built-in simulator mode. If 'Start Simulator' is selected, 'Stop Simulator' will appear as an option instead.

To activate (deactivate) simulator mode:

1. Highlight 'Start Simulator' (or 'Stop Simulator') and press ENTER.
2. Highlight 'Yes' and press ENTER.

Track Up— changes the sky view display from 'North Up' orientation to align to current direction of travel (track). If 'Track Up' is selected, 'North Up' will appear as an option instead.

To change the sky view orientation:

1. Highlight 'Track Up' (or 'North Up') and press ENTER.

AutoLocate— forces the GPS III+ to search for any available satellite(s) to determine its position. This option is useful if you've relocated a long distance (>500 miles) from the last location the GPS III+ was used.

To select AutoLocate, highlight 'AutoLocate' and press ENTER.

Initialize Position— allows you to designate your approximate position in order to speed up satellite acquisition. This option may be used in lieu of 'AutoLocate', above.

To initialize your starting position:

1. Highlight 'Initialize Position' and press ENTER.
2. Designate your approximate position on the map using the rocker keypad and press ENTER. (You may wish to use the IN/OUT zoom keys to adjust the level of detail displayed, as you determine your approximate position.)

Set 2D Altitude— allows you to designate your approximate altitude, when the GPS III+ is acquiring satellites or navigating in 2D mode. By default, 2D navigation will attempt to use the last known altitude. If the altitude shown is off by several hundred feet (or more), manually entering your approximate altitude will enable the receiver to more accurately determine a position fix.

To enter an altitude:

1. Highlight 'Set 2D Altitude' and press ENTER.
2. Enter your approximate altitude using the rocker keypad, and press ENTER.



'Initialize Position' is used to designate your approximate position directly on the map display. The receiver uses this information to determine which satellites should be in view.

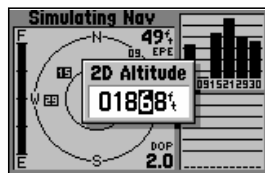

With 2D coverage, you will need to enter your approximate altitude. Without an approximate altitude, your position error can be substantial.

REFERENCE

Contrast and Backlighting

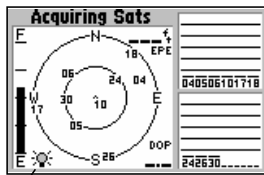

When screen backlighting is on, a bulb icon will appear in the lower-left corner of the Satellite Status Page.

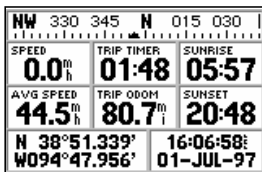

The Position Page shows you where you are, what direction you're heading and how fast you're going.

Contrast and Backlighting

On page 25, we introduced display contrast and backlighting adjustments accessible from the Satellite Status Page. Display settings can also be adjusted from any page, by pressing the red power key. When backlighting is on, a bulb icon will appear on the Satellite Status Page, to the bottom left of the sky view. To adjust the duration of the screen backlighting, refer to the operation setup section (see pg. 77).

To adjust the screen contrast and/or backlighting from any page:

1. Press the red power key momentarily. A window will appear showing the current contrast and backlighting settings.
2. Press LEFT or RIGHT on the rocker keypad to adjust the level of contrast, and press ENTER to save the new contrast setting.
3. Press UP or DOWN on the rocker keypad to adjust the level of backlighting, and press ENTER to save the new backlight setting.

Position Page

The second page in the GPS III+'s main page sequence is the Position Page. This page shows you where you are, what direction you're heading, and how fast you're going, and it's most useful when you are traveling without an active destination waypoint. The graphic heading display at the top of the page indicates the direction you're heading, or track, only while you're moving.

Directly below this display are the speed, average speed, trip timer, trip odometer and sunrise/sunset fields (default). The sunrise/sunset times indicated are for your present position. These times, and the current time display in the lower-right corner, can be displayed in local or UTC (universal) time. The lower left-hand corner of the page shows your current latitude and longitude in degrees and minutes (default). The GPS III+ uses this basic information to mark exact positions as waypoints, which help guide you from one place to another. Average speed, sunrise and sunset times (at

your present position) also appear on the Position Page (as default selections). Units of measure and the position readout are selectable from the Main Menu, as outlined on page 74-75. ‘Trip Computer’ functions—such as average speed, max speed, trip odometer and trip timer—can each be reset from the Main Menu, as described on page 74.

Many features of the GPS III+ are menu driven. Each of the main pages has an options menu, allowing you to custom tailor the corresponding page to your preferences and/or select special features which specifically relate to that page.

To display the Position Page Options, press MENU (with the Position Page displayed).

The following options are available:

Average Position— allows you to average position samples over time and save the averaged result as a waypoint. Averaging reduces the effects of selective availability on position error and results in a more accurate position reading.

To average position samples and save the result as a waypoint:

1. Highlight ‘Average Position’ and press ENTER. The Average Position Page will appear. Observe the ‘Estimated Accuracy’ and ‘Measurement Count’ fields.
2. When the ‘Estimated Accuracy’ and/or ‘Measurement Count’ figures reach the desired value(s), highlight ‘Save’ and press ENTER. (To cancel the averaging function, highlight ‘Discard’ and press ENTER.)
3. The New Waypoint Page appears with a three-digit number assigned as a name for the new waypoint. To save the waypoint with this name, highlight ‘Done’ and press ENTER. **Or,**
4. To change the waypoint name, highlight the waypoint name field and press ENTER. Use the rocker keypad to enter a new name for this waypoint and press ENTER when finished. Highlight ‘Done’ and press ENTER to save the waypoint.



The Position Page Options allow you to average position samples and save the result as a waypoint, change data fields or restore factory defaults.

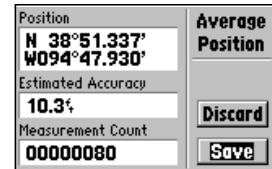

When averaging positions to create a waypoint, observe the ‘Estimated Accuracy’ and ‘Measurement Count’ figures. When they reach the desired value(s), highlight ‘Save’ and press ENTER.

REFERENCE

Position Page Options

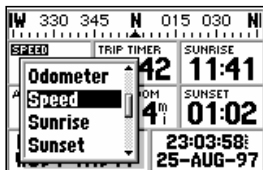

'Change Fields' allows you to custom tailor the information that appears on the Position Page. Select the desired data type from the list.



'Restore Defaults' will override any data field changes you've made to the Position Page, reverting back to the factory default settings.

Change Fields— allows you to choose the data displayed on the six user-selectable data fields. Available data types are: Altitude, Average (Avg) Speed, Battery (Bat) Timer, Max Speed, Odometer, Speed, Sunrise (at present position), Sunset (at present position), Track, Trip Odometer, Trip Timer, User Timer and Voltage. See page 95 for descriptions of navigation terms.

To change a data field:

1. Highlight 'Change Fields' and press ENTER.
2. Highlight the data field you wish to change (using the rocker keypad) and press ENTER.
3. Select the type of data you want to appear on this field and press ENTER.

Restore Defaults— resets all data fields to the factory default settings.

To restore the factory default settings, highlight 'Restore Defaults' and press ENTER.

The GPS III+ features a powerful real-time moving map that can do much more than just plot your course and route. The Map Page also displays background detail, including geographic names, lakes, rivers, coastlines and highways. An on-screen cursor lets you pan ahead to nearby waypoints, determine the distance and bearing to any map position, mark new waypoints while you navigate or retrieve exit information. The GPS III+ also features dedicated zoom keys for instant zooming (see pg. 2). The map portion of the page displays your present position as a pointer icon, with your track and/or route displayed as small points on the screen (an electronic bread crumb trail, if you will). Nearby waypoints are represented with names and symbols. You may select which features are shown via the Map Page Options (see pg. 36).

The data window beside (or above when display is vertical) the map displays the time and distance to next waypoint, plus your current speed (all defaults). A bearing pointer lets you know if you're heading toward your destination. (If the pointer points straight ahead, you're heading directly to it.) Each data field may be configured to display any one of twenty-four data options.

Zooming and Panning

There are three main functions you can perform from the Map Page: zooming, panning, and pointing. The map has 24 map scales (from 120 feet to 500 miles, or 30 meters to 800 km) which are selected by pressing the IN and OUT zoom keys. The current map scale is indicated in the bottom left corner of the map display.

To change the map scale:

1. Press zoom IN to see a smaller area with more detail.
2. Press zoom OUT to see a larger area with less detail.

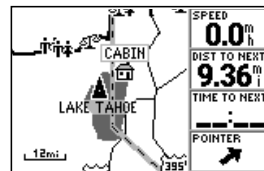

The Map Page displays a digital map, including lakes, rivers, highways, highway exits and towns.

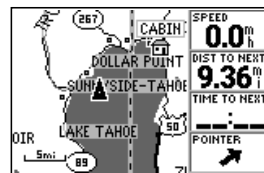

Zoom IN to see more detail for a smaller area. Zoom OUT to see a larger area.

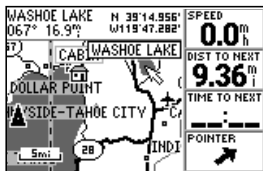

Use the rocker keypad to pan away from your present position. Place the arrow on a waypoint and press ENTER to see more information.

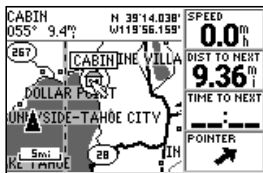

By placing the panning arrow over an on-screen waypoint and pressing GOTO, you won't have to manually select your destination from the GOTO Page.

Another function on the Map Page is the pan function, which allows you to move the map with the keypad in order to view areas beyond the current map.

To activate the pan function:

1. Use the rocker keypad to move the map in any direction, including diagonally.

As you begin to pan on the map, an arrow appears. This arrow will serve as a target marker for the map. When the arrow is placed on an object, the name of that object will be highlighted. (If the name wasn't originally displayed it will appear when the arrow is placed on the object.) This feature applies to waypoints, roads, lakes, rivers—pretty much everything displayed except route lines and track log data.

When a waypoint name is highlighted, you can review information about the waypoint, list waypoint options, or execute a GOTO right from the Map Page.

To select an on-screen waypoint with the panning arrow:

1. Use the rocker keypad to highlight the desired waypoint.
2. Press ENTER to review information for the selected waypoint.
3. To exit the information page, press QUIT.

To GOTO a highlighted waypoint:

1. With the waypoint highlighted, press GOTO, followed by ENTER.

The GOTO function can be used anywhere on the map. If a waypoint or highway exit is not highlighted, a new waypoint (called 'MAP') will be created at the arrow location before the GOTO is initiated.

To cancel the pan function and re-center the map on your position:

1. Press the QUIT key.

Highway exit information is also available when using the pan function. Simply place the panning pointer over the exit location to retrieve additional information—including available services—about the exit. Exit information is generally limited to interstate highways and is categorized into two types:

Common Exits— traditional ramp, cloverleaf or intersection exits.

Special Exits— rest areas, service areas, toll booths, welcome centers and weigh stations.

Common exits are depicted with an open square icon when services are available and a filled-gray square icon when no services are available.

To display available services for an exit shown on the map page:

1. Use the rocker keypad to place the panning arrow on the desired exit. A window will appear showing the exit number, along with icons depicting the available services.
2. Press ENTER to display the Exit Info Page for the selected exit. The Exit Info Page shows the number of available services, and the bearing and distance to the exit location.
3. Highlight the “View” button at the bottom of the page and press ENTER to display the Services Near Exit List. The Services Near Exit List shows a service icon and the name for each available service.
4. Highlight the desired service and press ENTER to display an Exit Service Detail Page. This page provides a checklist of available services—such as fuels, parking, convenience stores, etc.
5. Press QUIT, as often as needed, to back out of each exit services page. If you continue to press QUIT, you will return to the Map Page.

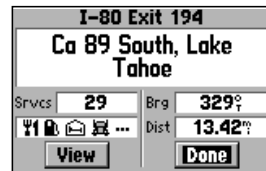

For a selected highway exit, the Exit Info Page displays the number of available services and icons depicting the type of available services.

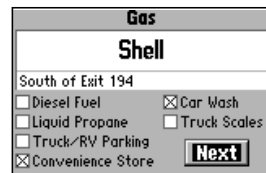

The Exit Services Detail Page provides a checklist of available services. Start from the Services Near Exit List and select the desired service to display this page.

REFERENCE

Map Page Options

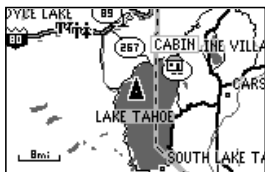

A full-screen map, without the data fields, is available by selecting the 'Data Fields Off' option.



The 'Change Fields' option allows you to select the desired data you wish to display in the four user-selectable fields (along the right-hand side of the map page).

Many GPS III+ features are menu driven. Each of the main pages has an options menu, allowing you to custom tailor the corresponding page to your preferences and/or select special features which specifically relate to that page.

To display the Map Page Options, press MENU (with the Map Page displayed).

The following options are available:

Data Fields On/Off—allows you to toggle between a full-screen map display or the default map display with data window. If the data fields are off, 'Data Fields On' will appear as an option instead and vice-versa.

To turn the data fields off (or on), highlight 'Data Fields Off' (or 'Data Fields On') and press ENTER.

Change Fields—allows you to choose the data displayed on four user-selectable data fields. There are twenty-four available data types, including Average (AVG) Speed, Bearing, Distance, ETA to Destination (DEST), Speed, Time to Destination (DEST), Track and a Trip Odometer. See page 95 for descriptions of navigation terms.

To change a data field:

1. Highlight 'Change Fields' and press ENTER.
2. Highlight the data field you wish to change and press ENTER.
3. Select the type of data you want to appear on this field and press ENTER.

MapSource Info— shows the number of maps downloaded from the optional MapSource software package and the amount of memory used (in kilobytes). MapSource allows you to supplement the built-in map with up to 1.44 MB of additional detail, including residential streets and topographic information. Each downloaded map is described by name, and may be deselected if you wish to retain the map in memory, but not display the data on the Map Page. (When a MapSource file is selected, the boundary for any downloaded map is shown on the Map Page as a gray shaded outline.)

To display the MapSource Info Page:

1. Highlight 'MapSource Info' and press ENTER.
2. Use the rocker keypad to scroll through the list of downloaded maps.
3. To select/deselect a map, highlight the box to the immediate left of the desired map. Press ENTER to select/deselect the map. The map is selected and will be displayed on the Map Page when an "X" appears in the box adjacent to that map.
4. To Enable/Disable All maps, press MENU from the MapSource Info Page, select the desired setting, and press ENTER.

Measure Dist— allows you to measure the bearing and distance between any two points on the map display.

To measure bearing and distance between two points:

1. Highlight 'Measure Dist' and press ENTER. An on-screen pointer will appear on the map display at your present position.
2. Move the cursor to the desired reference point (the point you want to measure from) and press ENTER.
3. Move the cursor to the point you want to measure to. The bearing and distance from the reference point will be displayed at the top of the page.

Map-Source Info	KBytes Used	1328 of 1440
	Maps Loaded	6 of 25
<input checked="" type="checkbox"/>	US Road & Rec - Continental US Arapahoe Co, Colorado	
<input checked="" type="checkbox"/>	US Road & Rec - Continental US Jefferson Co, Colorado	
<input checked="" type="checkbox"/>	US Road & Rec - Continental US Boulder Co, Colorado	

The MapSource Info page lists any detailed maps that have been downloaded from the optional MapSource software package.

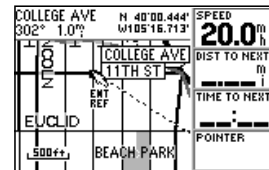

When using the 'Measure Dist' option, the arrow includes an 'Enter Reference' prompt and the arrow position appears at the top of the map display.

REFERENCE

Map Page Options



The 'Nearest to Pntr' option will only be available when the pointer is moved on the screen.

Waypoints	Cities	Exits	Geo Pnts
Exit on I-35	Brg	Dist	
□ 217	139 [°]	3.0 ^m	
□ 218	120 [°]	2.5 ^m	
□ 220	074 [°]	3.2 ^m	
□ 222ab	059 [°]	5.2 ^m	
□ 224	052 [°]	6.5 ^m	

The exit with the arrow to the left of the number is the next exit ahead, given your direction of travel. Exits which appear above in the list are the closest the opposite direction.

Nearest to Pntr (Pointer)— allows you to view the bearing and distance of the nine nearest waypoints, 50 nearest cities, 50 exits on the nearest (interstate) highway and 50 geo (geographical) points nearest to the map pointer. The nearest locations pages are organized by a series of 'file tabs' (denoting categories for Waypoints, Cities, Exits and Geo Points) and display the bearing (BRG) and distance (DST) to each nearby location for the selected tab (category). The lists are continuously updated as you're moving and provide quick access to the closest points of safety in an emergency.

To view points nearest the map pointer:

1. Use the rocker keypad to move the cursor to the desired position on the Map Page.
2. Press the MENU key, then highlight 'Nearest to Pntr' and press ENTER.
3. Highlight the appropriate tab (Waypoints, Cities, Exits or Geo Pnts) for the desired nearest list.
4. Scroll through the list using the UP/DOWN portion of the rocker keypad.

To view additional information for a nearby item:

1. Scroll through the selected nearest list (as described above) and highlight the desired item (Waypoint, City, Exit or Geo Pnts).
2. Press ENTER to display the info page for the selected item.
3. For waypoints, the information is displayed on the Waypoint Edit Page. You can edit the waypoint's location, name, symbol, etc. from this page, as outlined on pages 50-51.
4. For cities, the information includes state, country, size or reference, and position. You can show the map area for the city, save it as a waypoint or switch between city size and reference information as described on pages 69-70.

REFERENCE

Map Page Options

- For exits, all the exit services information (described on page 35) is available. You can show the map area for the point or save it as a waypoint.
- For geo points, the information includes geographic points, rivers/lakes, park areas and airports. If you do not have optional MapSource data loaded, only airports will be shown. You can show the map area for the point or save it as a waypoint.

Options menus available from the Cities, Exits and Geo Pnts info pages allow you to select special features which specifically relate to that page.

Show Map— allows you to return to the map, centered on the selected item. While viewing the map display, you can also use the IN and OUT zoom keys to see additional detail.

To view the map area around an item on the City, Exit, or Geo Pnts Info Pages:

- Press MENU, then select 'Show Map' (from the Info Page Options) and press ENTER. Press QUIT to return to the previous screen.

Save As Waypnt— creates a waypoint at the item location and saves it in memory. If the item name is longer than six characters, it will be abbreviated when creating the waypoint.

To save an item as a waypoint from the City, Exit, or Geo Pnt Info Page:

- Press MENU, then select 'Save As Waypnt' and press ENTER.
- With 'Done' highlighted, press ENTER to save the new waypoint.

Show Reference (For cities only)— See page 70 for details.

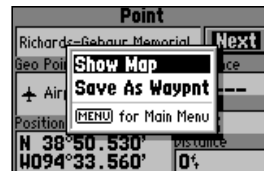

Menu options for Geo Pnts.

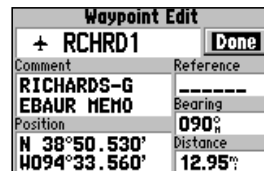

Items with names longer than six characters will be abbreviated when saved as a waypoint or activated as an active GOTO.

REFERENCE

Map Page Options



Geo Pnts setup allows you to choose what category items are to be displayed.



Pressing MENU from the Services Near Exit page displays options for the Services Near Exit List. See page 54 for details.

Options menus are also available for the Cities, Exits and Geo Pnts lists which allow you to select special features which specifically relate to that page. These options include a setup feature to exclude those item categories you don't wish to view and a setting to restore defaults. To view these options press MENU from the nearest Cities, Exits or Geo Pnts lists.

Cities/Exits/Geo Pnts Setup— allows you to designate which item categories you wish to display on the City, Exit services or Geo Pnts list pages. See page 54 for setup instructions.

Restore Defaults— resets all options to the factory default settings for the current list only.

To restore the factory default settings, highlight 'Restore Defaults' (from any list option window) and press ENTER.

Map Setup— allows you to configure the map display to your preferences, including map detail, map orientation, automatic zoom, lat/lon grid, track and route lines, exits and waypoint names. The map setup option uses a 'file tab' feature, making it easier to organize the various settings and easier for you to use. The following table lists the file tabs and the settings available under each tab:

Map	Detail, Orientation, AutoZoom, Accuracy Circle
Source	Built-in Base Map, MapSource Files
Line	Track Log, Active Route Lines, Local Roads, Street Labels
Pnts	All Waypoints and Text, Active Route Wpts, Exits
City	Large/Medium/Small Cities and Small Towns Text
Geo	Geo Points, Rivers/Lakes, Park Areas
Topo	Major/Medium/Minor Contours, Land Cover
Other	Marine Nav aids, Railroads, Metro Areas, Lat/Lon Grid

NOTES: Large cities are those with approximate populations greater than 200,000. Medium cities are those with approximate populations over 50,000 and small cities are greater than 5,000. Small towns have approximate populations under 5,000 or an unknown population size.

The 'Detail' setting applies to any map feature set to "Auto". Those features for which you have specified a maximum scale, or turned "Off", are unaffected by the detail setting.

To change a map setup feature:

1. Highlight 'Map Setup' and press ENTER.
2. To set the desired map detail, select the 'Map' tab (if not already selected). Scroll down (using the rocker keypad) to highlight the 'Detail' field and press ENTER. Select the desired detail level—More, Normal, Less, Least—and press ENTER.



'Map Setup' allows you to change map orientation, background map detail, text size, etc.

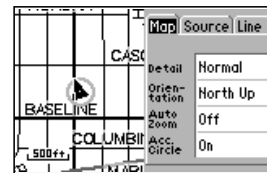

The map settings are organized by a series of 'file tabs'. Use the rocker keypad to select the desired tab, and to select the desired setting(s).

REFERENCE

Map Page Options

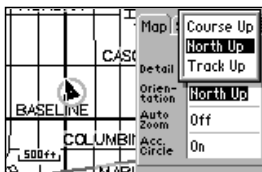

Select the 'North Up' option to keep the top of the map display fixed on North. 'Track Up' will cause the map to rotate so the top of the map is the direction you're heading.



The 'Zoom' setting allows you to define the maximum scale at which the feature will appear. Select "Auto" to control the feature using the 'Detail' setting.

- To change map orientation, select the 'Map' tab (if not already selected). Scroll down to highlight the 'Orientation' field and press ENTER. Select 'North Up' to fix the top of the map display to a north heading. Select 'Track Up' to adjust the top of the map display to your current track heading. Select 'Course Up' to fix the top of the map display to your desired course. Press ENTER to accept the selected option.
- To enable/disable automatic zoom, select the 'Map' tab (if not already selected). Scroll down to highlight the 'Auto Zoom' field and press ENTER. Select 'On' or 'Off' to enable or disable automatic zoom. Press ENTER to accept the selected option. The automatic zoom feature will automatically adjust the map scale from 80 miles through each lower scale, stopping at 800 ft. as you approach your destination waypoint.
- To enable/disable the accuracy circle, select the 'Map' tab (if not already selected). Scroll down to highlight the 'Acc. Circle' field and press ENTER. Select 'On' or 'Off' to enable or disable the accuracy circle. Press ENTER to accept selected option. With the accuracy circle on, a gray circle will appear around your position (at lower scale settings) depicting the estimated accuracy of your position reading.
- To enable/disable the built-in base map or MapSource files, select the 'Source' tab. Scroll down to highlight 'Basemap' or 'MapSource' and press ENTER. Select 'On' or 'Off' to enable or disable the selected map data and press ENTER.
- For all waypoints, active route waypoints, rivers/lakes and cities: select the appropriate tab (per the chart on page 41). Scroll down to highlight the zoom field for the desired feature and press ENTER. Select the maximum scale at which the feature should appear on screen, or 'Off' to never display, and press ENTER. Highlight the text field for the desired feature and press ENTER. Select the text size for the desired feature, or 'None' to disable text, and press ENTER.
- For track log data, active route lines, local roads, street labels, highway exits, lat/lon grid, metro areas, and railroad lines: select the appropriate tab (per the chart on page 41). Scroll down to highlight the zoom field for the desired feature and press ENTER. Select the maximum scale at which the feature should appear on screen, or select 'Off' to never display the feature. Press ENTER to accept the settings.

REFERENCE

Compass Page

Whenever a destination waypoint(s) has been selected, the GPS III+'s Compass Page will guide you to your destination with digital readouts and a graphic compass display, which includes a bearing pointer. Use this page (instead of the Highway Page) when travelling at slower speeds, when making frequent directional changes, or where straight line navigation is not possible due to obstructions or terrain.

The middle of the page features a rotating 'compass ring' that shows your course over ground (track) while you're moving. (Your present course over ground is indicated at the top of the compass ring.) A bearing pointer, in the middle of the compass ring, indicates the direction of the destination (bearing) relative to the course over ground. The compass ring and pointer arrow work independently to show—at a glance—the direction of your movement and the direction to your destination. For instance, if the arrow points up, you are going directly to the waypoint. If the arrow points any direction other than up, turn toward the arrow until it points up—then continue in that direction.

Along the right side of the page (top, when display is vertical) are four user-selectable data fields that display current speed, distance and time to next waypoint, and current time (defaults). Each data field may be configured to display any one of twenty-five data options.

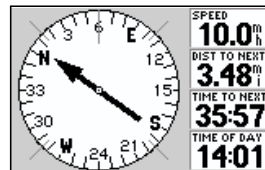
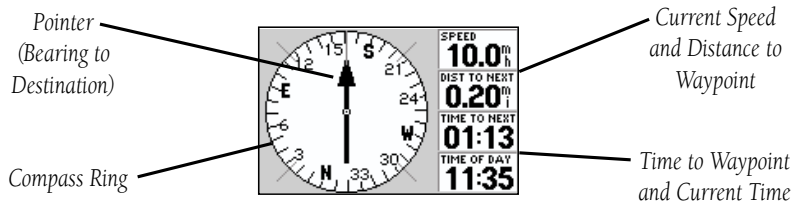

The bearing pointer indicates the direction (bearing) to your destination. If the arrow points any direction other than up, turn toward the arrow until it points up.

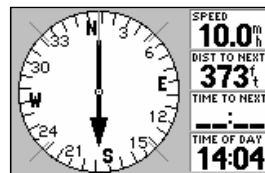

If you pass your destination waypoint, the bearing pointer will swing around 180° and the 'Dist to Next' waypoint will increase.

REFERENCE

Compass Page Options

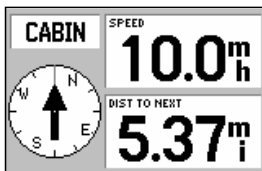

'Big Numbers' provides a smaller compass display, a large bearing pointer, and two user-selectable, large character data fields.

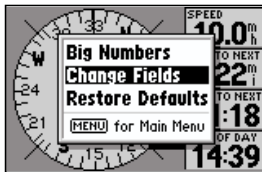

The 'Change Fields' option allows you to select from a list of available data types. Four different items may be displayed on the Compass Page—two when using the 'Big Numbers' option.

Many features of the GPS III+ are menu driven. Each of the main pages has an options menu, allowing you to custom tailor the corresponding page to your preferences and/or select special features which specifically relate to that page.

To display the Compass Page Options, press MENU (with the Compass Page displayed).

The following options are available:

Big Numbers— allows you to select a different Compass Page layout, with a smaller compass display and two user-selectable, large-character data fields. If 'Big Numbers' is selected, 'Big Compass' will appear as an option instead.

To toggle between Compass Page formats, highlight 'Big Numbers' (or 'Big Compass') and press ENTER.

Change Fields— allows you to choose the data displayed on four user-selectable data fields (two fields for the 'Big Numbers' option). There are twenty-five available data types, including Average (AVG) Speed, Bearing, Distance (DIST) to Destination, ETA to Destination (DEST), Speed, Time to Destination (DEST), Track, and a Trip Odometer. See page 95 for descriptions of data terms.

To change a data field:

1. Highlight 'Change Fields' and press ENTER.
2. Highlight the data field you wish to change and press ENTER.
3. Select the type of data you want to appear on this field and press ENTER.

Restore Defaults— resets all data fields to the factory default settings.

To restore the factory default settings, highlight 'Restore Defaults' and press ENTER.

REFERENCE

Highway Page

The GPS III+'s Highway Page also provides graphic steering guidance to your destination, by using a graphic highway display. Along the right side of the page (top, when display is vertical) are four user-selectable data fields that display current speed, distance and time to next waypoint, and a bearing pointer (defaults). The bearing pointer always points to the destination waypoint (or the next waypoint when using a route) relative to the direction you are moving (track). If the bearing pointer points straight ahead, you are heading directly to your destination. If the bearing pointer points any direction other than up, turn toward the arrow until it points up—then continue in that direction. Each data field may be configured to display any one of twenty-three data options.

The graphic heading compass at the top of the page indicates the direction you are moving (track). Directly below the heading compass, the highway display provides visual guidance to the destination waypoint and keeps you on your intended course line. Your course is represented by the center line down the middle of the graphic highway. As you head toward your destination, the highway perspective will move to indicate your progress to the waypoint and which direction you should steer to stay on course. If you are navigating a route, the highway display will show each route waypoint in sequence, with the route course indicated by a black highway. Nearby waypoints not in the route will also be displayed. You can zoom in or out on the highway display for a smaller or larger view. Five available settings range from 1X to 16X, with a default setting of 8X.

To zoom in or out on the highway display:

1. Press the IN zoom key to increase the zoom level and show a smaller view area.
2. Press the OUT zoom key to decrease the zoom level and show a larger view area.

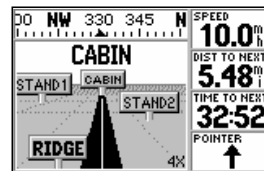

Your course is represented by the highway center line. Keep the center line in the middle of the display to stay on course.

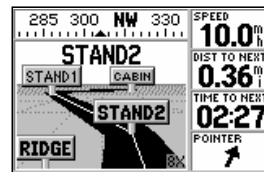

When using a route, the Highway Page will guide you to each waypoint along the route.

REFERENCE

Highway Page Options



The 'Sign Posts Off' option allows you to remove the waypoint markers from the highway display.

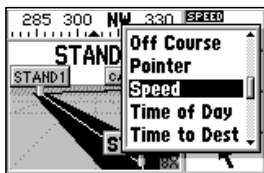

The 'Change Fields' option allows you to choose the type of data to display on four user-selectable data fields. Select the desired type from the 'Change Fields' list.

Many features of the GPS III+ are menu driven. Each of the main pages has an options menu, allowing you to custom tailor the corresponding page to your preferences and/or select special features which specifically relate to that page.

To display the Highway Page Options, press MENU (with the Highway Page displayed).

The following options are available:

Sign Posts Off— removes the waypoint markers from the highway display. If 'Sign Posts Off' is selected, 'Sign Posts On' will appear as an option instead.

To remove (or display) waypoint markers on the highway, highlight 'Sign Posts Off' (or 'Sign Posts On') and press ENTER.

Change Fields— allows you to choose the data displayed on four user-selectable data fields. There are twenty-three available data types, including Average (AVG) Speed, Bearing, Distance (DIST) to Destination, ETA to Destination (DEST), Speed, Time to Destination (DEST), Track, a Trip Odometer and a bearing Pointer. See page 95 for data type descriptions.

To change a data field:

1. Highlight 'Change Fields' and press ENTER.
2. Highlight the data field you wish to change and press ENTER.
3. Select the type of data you want to appear on this field and press ENTER.

Restore Defaults— resets all data fields to the factory default settings.

To restore the factory default settings, highlight 'Restore Defaults' and press ENTER.

REFERENCE

Creating Waypoints

The GPS III+ stores up to 500 waypoints, with a selectable symbol and comment available for each waypoint. Waypoints can be created using five methods:

Mark Present Position— your present position can be captured and saved as a waypoint using the ENTER/MARK key.

On Map— a new waypoint position can be created directly on the map display using the panning arrow.

Text Entry— waypoints can be created by entering position coordinates manually (from a chart, etc.) or by referencing bearing and distance from a previously stored waypoint (or present position).

Average Position— position samples can be averaged over time and the result saved as a waypoint. Averaging reduces the effects of selective availability and improves the accuracy of the position reading. (See page 31 for more info.)

Nearest Locations— nearest cities or highway exits can be saved as waypoints from the nearest locations pages. (See page 53 for more info.)

Marking Present Position

The GPS III+'s mark feature lets you quickly capture your present position in order to create a new waypoint. You must be locked onto satellites, with a valid position fix, to mark your present position.

To mark your present position:

1. Press and hold the ENTER/MARK key. The Mark Waypoint Page is automatically displayed.
2. To change the waypoint name (a three-digit number is automatically assigned), highlight the waypoint name field and press ENTER. Use the rocker keypad to enter the new waypoint name and press ENTER when finished.
3. To save the waypoint in memory, highlight 'Done' and press ENTER.

Mark Waypoint	
■ BEAC	Done
Comment	Reference
CRTD 17:07	-----
22-JAN-01	Bearing
Position	000°
N 38°51.335'	Distance
W094°47.930'	0%

The ENTER/MARK key allows you to mark your current position as a waypoint. You can give this waypoint any name you choose—up to six characters long.

Waypoint Symbol
Skiing Area
Soft Field
Summit
Swimming Area
Tall Tower

You can also choose from a list of symbols used to identify the user waypoint on the map display.

REFERENCE

Creating Waypoints

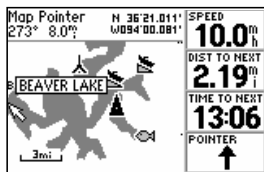

Waypoints can be created directly from the Map Page, by placing the panning arrow on the desired position and pressing ENTER.

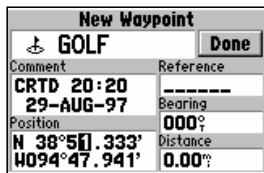

User waypoints can also be created by entering the position coordinates for the waypoint.

Marking Waypoints on the Map Page

Waypoints can also be quickly created from the Map Page, which allows you to “point and shoot” at any map position to create a new waypoint.

To create a new waypoint on the map:

1. Press the PAGE key repeatedly to select the Map Page.
2. Use the rocker keypad to move the arrow to the desired map position. You may also need to use the IN and OUT zoom keys, in conjunction with the rocker keypad, to speed up this process.
3. Press ENTER to capture the arrow position and display the New Waypoint Page. (If the arrow is placed on a highway exit, the exit services pages will appear instead. To create a waypoint at a highway exit location, see page 39.)
4. To change the waypoint name (a three-digit number is automatically assigned), highlight the waypoint name field and press ENTER. Use the rocker keypad to enter the new waypoint name and press ENTER when finished.
5. To save the waypoint in memory, highlight ‘Done’ and press ENTER.

Creating Waypoints by Text Entry

Waypoints may be created by manually entering the position coordinates or by entering the bearing and distance from an existing waypoint (or present position).

To create a new waypoint by manually entering its coordinates, or by bearing/distance from another position:

1. Press the MENU key twice to select the Main Menu.
2. Highlight ‘Waypoints’ and press ENTER. A list of all waypoints stored in memory is displayed.
3. Press MENU to display the Waypoint List Options.

4. Highlight 'New Waypoint' and press ENTER. The New Waypoint Page appears.
5. To enter a name for the new waypoint, highlight the waypoint name field and press ENTER. Use the rocker keypad to enter the waypoint name and press ENTER when finished.
6. To enter position coordinates for the new waypoint, highlight the waypoint coordinates field and press ENTER. Use the rocker keypad to enter the position coordinates and press ENTER when finished. (For lat/long coordinates, enter both the latitude and longitude information before pressing ENTER.) **OR**,
7. To create the new waypoint by referencing another position, highlight the reference waypoint name field and press ENTER. Use the rocker keypad to enter the name of the reference waypoint and press ENTER. (If the reference waypoint name field is left blank, your present position will be used as the reference position.) Use the same procedure to enter the bearing (BRG) and distance (DIST) from the reference waypoint to the new waypoint. (Remember to press ENTER once each data item is selected with the rocker keypad.)
8. To save the new waypoint in memory, highlight 'Done' and press ENTER.

Waypoint List Options

The Waypoint List Options were displayed using the first three steps, above. In addition to 'New Waypoint', there are five additional options:

Show Map— allows you to view the map area around the highlighted waypoint on the Waypoint List. While viewing the map display, you can also use the IN and OUT zoom keys to see additional detail.

To view the map area around a highlighted waypoint on the Waypoint List:

1. Select 'Show Map' (from the Waypoint List Options) and press ENTER.



You can choose from a list of symbols used to identify the waypoint on the map display.



The Spell 'n Find option allows you to retrieve waypoint information by manually entering the waypoint's name with the rocker keypad.

REFERENCE

Editing Waypoints



Waypoints can be deleted individually, by common symbol or all at once. Select the desired 'Delete' option and press ENTER.

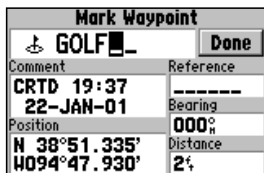

To rename a waypoint, enter the new name directly over the old name and press ENTER.

Spell 'n Find— allows you to display the Waypoint Edit Page for any waypoint in memory, by typing in the first few characters of the waypoint's name.

To Spell 'n Find a waypoint:

1. Select the Spell 'n Find option and use the rocker keypad to enter the first few characters of the waypoint name.
2. Press ENTER to view waypoints starting with characters entered.

Delete Waypoint— allows you to delete the waypoint which is highlighted on the Waypoint List.

Delete by Symbol— allows you to select a waypoint symbol and all waypoints with this corresponding symbol will be deleted from memory.

Delete All— deletes all waypoints currently stored in memory.

To delete a waypoint (or waypoints):

1. Select the desired delete option from the list above and press ENTER. The GPS III+ will delete all waypoints not used in a route, then prompt you to continue before deleting any route waypoints.
2. If 'Delete by Symbol' is selected, select the desired symbol and press ENTER.

Editing Waypoints

Once you have created and stored a waypoint, it may be modified, reviewed, renamed or deleted at any time through the Waypoint Edit Page. The Waypoint Edit Page for any stored waypoint can be retrieved by highlighting the desired waypoint on the map display, or selecting it from any waypoint list, and pressing the ENTER key.

To access the Waypoint Edit Page:

1. Use the rocker keypad to highlight the desired waypoint on the map display or on any waypoint list.
2. Press ENTER to display the Waypoint Edit Page for the selected waypoint.

From the Waypoint Edit Page, highlight the appropriate field to rename a waypoint, change its symbol, edit the comment or edit the position.

To rename the waypoint:

1. Highlight the waypoint name field and press ENTER.
2. Use the rocker keypad to enter the new waypoint name and press ENTER.
3. If finished, highlight 'Done' and press ENTER.

To change the waypoint's symbol:

1. Highlight the waypoint symbol field and press ENTER.
2. Use the rocker keypad to select the desired symbol and press ENTER. The selected symbol will be used to denote the waypoint position on the map display.
3. If finished, highlight 'Done' and press ENTER.

When a waypoint is created, the time and date of creation is automatically added as a waypoint comment. You can edit this information or create a entirely new comment, as needed.

To edit the waypoint comment:

1. Highlight the waypoint comment field and press ENTER.
2. Use the rocker keypad to enter the desired comment and press ENTER.
3. If finished, highlight 'Done' and press ENTER.

To edit the waypoint position:

1. Highlight the waypoint coordinates field to change the position coordinates, or highlight the reference waypoint name, bearing or distance fields to change the reference waypoint information. Press ENTER to begin editing.
2. Use the rocker keypad to enter the new information. Press ENTER to accept the new information.
3. When finished, highlight 'Done' and press ENTER.

Waypoint Edit	
■ GOLF	Done
Comment	Reference
BELLA VIST	-----
Position	Bearing
N 38°51.333'	000°?
W094°47.941'	0.00°?

The default waypoint comment is the time and date the waypoint was created. You can enter your own comment using the rocker keypad.

Waypoint Edit	
■ GOLF	Next
Comment	Reference
BELLA VISTA	-----
Position	Bearing
N 36°29.023'	312°?
W094°17.941'	16.10°?

Edit a waypoint's position by entering the new position coordinates directly over the old position.

REFERENCE

Waypoint Edit Options



'Show Map' allows you to view the area around the waypoint's position.

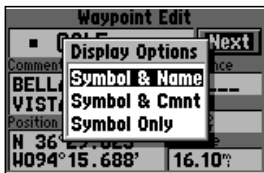

'Display Options' lets you determine what waypoint information will appear on the map display.

The Waypoint Edit Page also features an options page that allows you to delete the waypoint, view the map area around the waypoint position, define how the waypoint will appear on the map display or average the waypoint position to improve accuracy.

To display the Waypoint Edit Options, press MENU (with the Waypoint Edit Page displayed).

The following options are available:

Show Map— allows you to view the map area surrounding the selected waypoint's position. While viewing the map display, you can also use the IN and OUT zoom keys to see additional detail.

Display Options— lets you designate how the selected waypoint will appear on the map display. Options are provided to show Symbol & Name, Symbol & Comment (Cmnt), or Symbol Only.

To change the display options for a waypoint:

1. Highlight 'Display Options' and press ENTER.
2. Highlight the desired option and press ENTER.

Average Position— allows you to average position samples over time to update the waypoint's position with a more accurate position reading. (See page 31 for more information on averaging.)

Delete Waypoint— allows you to remove the selected waypoint from memory.

To delete a waypoint:

1. Highlight 'Delete Waypoint' and press ENTER. A confirmation screen is displayed.
2. ENTER to delete (or QUIT to cancel).

Another waypoint feature of the GPS III+ is the nearest locations pages, which show up to nine nearest waypoints and 50 nearest cities—within 200 miles of your present position—along with 50 exits on the nearest (interstate) highway and 50 nearest geo (geographic) points. The nearest locations pages are organized by a series of ‘file tabs’ (denoting categories for Waypoints, Cities, Exits and Geo Pnts) and display the bearing (BRG) and distance (DST) to each nearby location for the selected tab (category). The lists are continuously updated as you’re moving and provide quick access to the closest points of safety in an emergency.

To view the nearest locations pages:

1. Press the MENU key twice to display the Main Menu.
2. Highlight ‘Nearest’ and press ENTER.
3. Highlight the appropriate tab (Waypoints, Cities, Exits or Geo Pnts) for the desired nearest list.
4. Scroll through the list using the UP/DOWN portion of the rocker keypad.

To view additional information for a nearby location:

1. Scroll through the selected nearest list (as described above) and highlight the desired location (Waypoint, City or Exit).
2. Press ENTER to display an info page for the selected location.
3. For waypoints, the information is displayed on the Waypoint Edit Page. You can edit the waypoint’s location, name, symbol, etc. from this page, as outlined on pages 50-51.
4. For cities, the information includes state, country, size or reference, and position. You can show the map area for the city, save it as a waypoint or switch between size and reference information as described on pages 69-71.
5. For exits and geo points, all the additional pages and related options menus (described on pages 35, 39-40 and 54) are available.

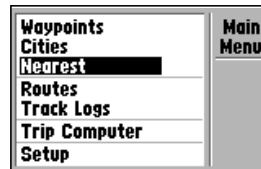

To view the nearest locations pages, select ‘Nearest’ from the Main Menu.

Waypoints	Cities	Exits	Geo P
Waypoint	Bearing	Distance	
FISH	024°	2.8°	
HTWHIT	077°	8.4°	
RAMP	078°	12°	
MARINA	080°	13°	
GOLF	311°	16°	

The nearest locations pages are organized as a series of “file tabs”. Select the appropriate tab to show as many as nine nearby waypoints, 50 nearest cities or 50 nearest highway exits—along with the bearing and distance to each.

REFERENCE

Nearest Location Options



The Nearest Location Options allows you to define the category of exits which will appear on the Nearest Exits List. Start by highlighting the 'Exits' tab, then press MENU.

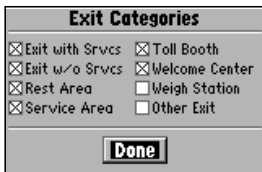

Select the exit categories you wish to appear on the Nearest Exits List. A category is enabled when an "X" appears in the box adjacent to the desired category.

To GOTO a nearby location:

1. Highlight the desired location on the selected nearest list. Press GOTO to display the GOTO Page with the desired location selected.
2. Press ENTER to confirm the selected waypoint and begin navigating.

Nearest Location Options

The nearest locations pages also feature an options page that allows you to define the category of items you want to appear on the Nearest Cities, Exits or Geo Pnts Lists or restore the factory default settings after you've made any changes.

To display the nearest location options for Nearest Lists:

1. From the nearest locations pages, highlight the a tab and press MENU.
2. Highlight the desired option and press ENTER.

The following options are available:

Cities/Exits/Geo Pnts Setup— allows you to define the item categories you wish to display on the Nearest Cities, Exits or Geo Pnts Lists.

To select the desired item categories:

1. Highlight 'Cities, Exits or Geo Pnts Setup' and press ENTER.
2. Highlight the field adjacent to the desired category and press ENTER to enable/disable the category. A category is selected, and will appear on the Nearest List, when an "X" appears in the field adjacent to that category.

Restore Defaults— resets all nearest settings to the factory defaults for the current list only.

The GPS III+ can navigate to a destination using any of four different methods:

GOTO— lets you select a waypoint as your destination and quickly plot a direct course from present position to that waypoint.

MOB (man overboard)— captures your present position, saves it as a waypoint and sets a course back to the position for quick response in an emergency.

TracBack— allows you to retrace your path using the track log automatically stored in the receiver's memory. This eliminates the need to store waypoints along the way. (See page 58 for more information about TracBack.)

Routes— allows you to manually create a sequence of intermediate waypoints which lead you to your final destination. The GPS III+ will store up to 20 reversible routes, with up to 30 waypoints in each route.

GOTO Navigation

The easiest way to select your destination is by using the GOTO key. The GOTO key can be used by itself, after highlighting a waypoint name on a list, or after designating a position on the map display.

To GOTO a waypoint:

1. Press GOTO. The GOTO Page shows a series of file tabs for 'Recent' waypoints, 'All' waypoints, 'Nearest' waypoints or 'Spell n Find'.
2. To GOTO a recently used waypoint or a nearby waypoint, select the 'Recent' tab or the 'Nearest' tab, highlight the desired waypoint on the list and press ENTER.
3. To GOTO any waypoint stored in memory, select the 'All' tab, highlight the desired waypoint and press ENTER.
4. To enter the name of the destination waypoint, highlight the waypoint name field and press ENTER. (The 'Spell n Find' tab is automatically selected.) Use the rocker keypad to enter the name of the desired waypoint—UP/DOWN to change each character and RIGHT to move to the next character. Press ENTER to confirm the selection.



To GOTO a waypoint, press GOTO and select the desired tab. Highlight the waypoint name field at the top of the page to spell the name of the desired destination waypoint.

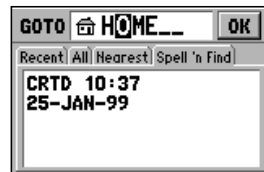

Press ENTER and use the rocker keypad to enter the identifier of the destination waypoint. Press ENTER again to confirm the waypoint and begin navigation.

REFERENCE

GOTO / GOTO Options

Waypoints	Cities	Exits	Geo	P
Waypoint	Bearing	Distance		
MTWHIT	062°	3.9 ^m		
FISH	304°	4.3 ^m		
RAMP	072°	6.9 ^m		
MARINA	074°	7.9 ^m		
GOLF	302°	20 ^m		

By highlighting a waypoint name on a list and pressing GOTO, you won't have to manually enter the name of your destination waypoint.

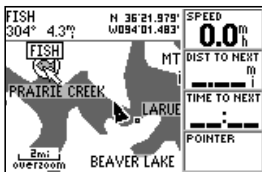

A GOTO can also be initiated from the map display by placing the panning arrow on the desired target waypoint, city or highway exit.

To designate a GOTO waypoint from a list of waypoints:

1. Highlight the desired waypoint on the list and press GOTO. A confirmation page shows the selected destination waypoint.
2. Press ENTER to confirm the selected waypoint and begin navigating.

To GOTO an existing waypoint, city or highway exit on the map display:

1. Use the rocker keypad to place the arrow on the desired target location. If a city or exit is selected, a waypoint will be created at that location using the city or exit name.
2. Press GOTO, followed by ENTER, to begin navigating.

To GOTO any position on the map display:

1. Use the rocker keypad to place the arrow on any position you wish to navigate to.
2. Press GOTO to create a waypoint, called 'MAP', at the arrow position. Each time you perform this step it will overwrite any previously created 'MAP' waypoint.
3. Press ENTER to be navigating.

GOTO Options

GOTO Options are also provided to initiate a TracBack route or cancel the current GOTO destination.

To display the GOTO Options, press MENU (immediately after pressing GOTO).

The following options are available:

TracBack— allows you to retrace your path using the track log automatically stored in the receiver's memory. This eliminates the need to store waypoints along the way. (See page 58 for more information about TracBack.)

Cancel GOTO— cancels the current GOTO destination and resumes navigation of any previously selected route. If no route is currently in use; bearing, distance, etc. will remain blank until a destination waypoint is defined.

To cancel the current GOTO destination, highlight 'Cancel GOTO' and press ENTER.

MOB (man overboard)

The GPS III+'s MOB function lets you simultaneously mark and set a course to a position for quick response in an emergency. Once an MOB has been activated, an MOB symbol will appear on the map display and the navigation screens will guide you back to the 'MOB' waypoint.

To activate the MOB function:

1. Press and hold GOTO to capture the MOB position.
2. Press ENTER to begin navigating back to the 'MOB' waypoint.
3. To cancel the MOB function, select 'Cancel GOTO' from the GOTO Options and press ENTER.



NOTE: Each time an MOB is activated, any previous 'MOB' position stored in memory will be overwritten and permanently lost. If you wish to save an 'MOB' waypoint for future use, you should give the waypoint a new name using the steps outlined on pages 50-51.



To cancel a current GOTO destination, select 'Cancel GOTO' from the GOTO Options.



Press and hold the GOTO key to activate the MOB (man overboard) feature.

REFERENCE

TracBack



Clear any old data from the active track log before you depart. This defines the starting point for a TracBack route.



A TracBack route can also be created from the GOTO Options by pressing GOTO, followed by MENU and selecting 'TracBack'.

The TracBack navigation feature allows you to retrace your path using the track log automatically stored in the receiver's memory. This eliminates the need to manually store waypoints along the way. A track log is an electronic breadcrumb trail, showing the path you have travelled. Your GPS III+ can be set to automatically record track log points any time the receiver is on and locked onto satellites (see page 71).

TracBack routes are created by reducing your track log into a route of up to 30 waypoints and activating the new route in reverse order along those waypoints. Once activated, a TracBack route will lead you back to the oldest track log point stored in memory, so it's a good idea to clear the active track log at the beginning of your current trip (e.g., at the dock or trailhead), before you get started.

To clear the active track log and define a starting point for a TracBack:

1. Press MENU twice to display the Main Menu.
2. Highlight 'Track Logs' and press ENTER.
3. With the 'Active Log' highlighted press MENU to display the options list.
4. Highlight 'Clear Active Log' and press ENTER.
5. Press ENTER to delete the track log data. (Or press QUIT to cancel.)

To create and activate a TracBack route:

1. Enable track log recording and leave the GPS III+ on to automatically record track log positions while under way. Refer to page 69 for more information on track log settings.
2. Press MENU twice to display the Main Menu.
3. Highlight 'Track Logs' and press ENTER.
4. Highlight the desired track log ('Active Log' or 'Saved Logs') and press MENU to display the options list.
5. Highlight 'TracBack' and press ENTER to create/activate the TracBack route. (A message box will appear while the GPS III+ analyzes the data and creates the route.)

REFERENCE

TracBack Tips

Once a TracBack has been activated, the GPS III+ will take the track log currently stored in memory and divide it into route segments, called 'legs'. Up to 30 track log waypoints (labeled 'T###', e.g. 'T001') will be created to mark the most significant features of the track log in order to duplicate your path as closely as possible. To gain the most benefit from the TracBack feature, keep the following tips in mind:

- Always clear the track log at the point you want to return to (boat ramp, dock, trailhead, etc.)
- The 'Record Mode' on the Track Logs Page must be set to 'Wrap' or 'Fill'.
- There must be at least two track log points stored in memory to create a TracBack route.
- If there is not enough available memory to add more waypoints and create a TracBack route, you will be alerted with a 'waypoint memory full' message. The receiver will use the available waypoints to create a route with an emphasis on the track log data closest to the destination. Also, existing TracBack waypoints ('T###') that are not contained in routes will be erased to free more memory. The GPS III+ will create new waypoints using the first available three-digit number.
- If the Track Logs Page 'Interval' field is set to 'Time', the route may not follow your exact path. (Keep the 'Interval' field set to 'Resolution' for best results.)
- If the receiver is turned off or satellite coverage is lost during your trip, TracBack will draw a straight line between any point where coverage was lost and where it resumed.
- If there are frequent changes in direction and distance in your track log, 30 waypoints may not accurately depict your exact path. The receiver will then assign the 30 waypoints to the most significant points of your track log, and simplify segments with fewer changes in direction.

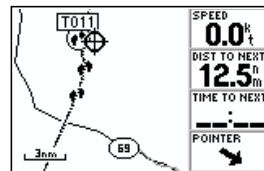

A TracBack route contains a series of waypoints labeled 'T###' that approximate your previous route of travel.



'Wrap' will overwrite the old track log data in memory, once all memory has been used. 'Fill' will record data until memory is full, then stop.

REFERENCE

Routes

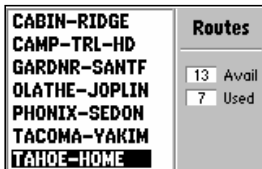

To display the Route List, showing all routes stored in memory, select 'Routes' from the Main Menu.



To create a new route, select 'New Route' from the Route Options and enter the identifiers for the route waypoints in the sequence you wish to follow them.

Route navigation allows you to manually create a sequence of intermediate waypoints which lead you to your final destination. The GPS III+ will store up to 20 reversible routes, with up to 30 waypoints in each route. Routes can be created and modified by text entry (using the rocker keypad to enter waypoint names) or directly from the map display. Using the map display allows you to see each route graphically on-screen as you create, review, modify or navigate the route. All of the GPS III+'s route functions are accessed through the Main Menu.

To create a new route by entering the name of each waypoint:

1. Press MENU twice to display the Main Menu.
2. Highlight 'Routes' and press ENTER. The Route List is displayed, showing all routes stored in memory.
3. Press MENU to display the Route Options.
4. Highlight 'New Route' and press ENTER. The GPS III+ creates a route called 'EMPTY-1'. (The name changes as you add waypoints to the route, so make note of the route name for future reference.)
5. Highlight the first waypoint name field and press ENTER to begin entering the name of an existing waypoint in memory.
6. Use the rocker keypad to enter the name of the route waypoint.
7. Press ENTER to accept the selected route waypoint.
8. Highlight the next waypoint name field, press ENTER and repeat steps 6 & 7 until all the waypoints have been added to the route.

To create a route from the map display:

1. Press MENU twice to display the Main Menu.
2. Highlight 'Routes' and press ENTER. The Route List is displayed, showing all routes stored in memory.
3. Press MENU to display the Route Options.
4. Highlight 'New Route' and press ENTER. The GPS III+ creates a route called 'EMPTY- 1'. (The name changes as you add waypoints to the route, so make note of the route name for future reference.)
5. Press MENU to display the New Route Options and highlight 'Show Map'.
6. Press ENTER and use the rocker keypad to place the arrow over the first route waypoint. (Use the IN and OUT zoom keys to aid in locating the desired waypoint.)
7. Press ENTER to accept the selected route waypoint.
8. Highlight the next waypoint on the map display and press ENTER to add the waypoint to the route. Repeat this step until all route waypoints have been added to the route. Press PAGE or QUIT to exit the page.
9. You can also create route waypoints during this process. If no waypoint exists at the arrow location, the GPS III+ will automatically create one—using a three digit number as the waypoint's name. (You can rename the waypoint following the steps on page 51.)
10. If you wish to include a city location in the route, place the arrow over the city and press ENTER. A confirmation page will appear with the name of the city as a new waypoint (sometimes abbreviated, depending on the length of the original name). To add to the route, select 'Use' and press ENTER.

As you add each new waypoint to the route, the data window at the top of the map display will show the name of the route you are creating, which includes the first and last waypoints in the route. A solid route line will appear on the map to indicate each leg, and a dotted line will appear to indicate the distance and bearing from the last route waypoint to the cursor position.



To create a route directly from the map display, select 'New Route' from the Main Menu, then select 'Show Map' from the New Route Options.

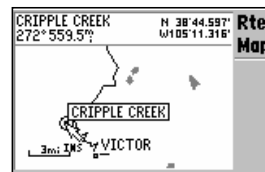

You can add city (or highway exit) locations to a route by placing the editing arrow on a city (or highway exit) and pressing ENTER.

REFERENCE

Route List

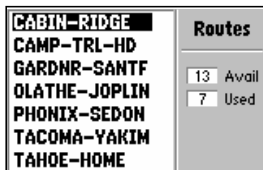

The Route List shows all routes currently stored in memory. Highlight the desired route and press ENTER to see the Route Plan Page.



Activating a route tells the GPS III+ you wish to use this route for navigation guidance.

The GPS III+'s Route List displays all the routes currently stored in memory, along with a descriptive name for each route. Once a route has been created, it can be activated and used for navigation from the Route List. A route may be followed in the same sequence as it was originally created, or you can invert the route and navigate from the end waypoint back to the beginning waypoint.

To activate a route:

1. Press MENU twice to display the Main Menu.
2. Highlight 'Routes' and press ENTER. The Route List is displayed, showing all routes stored in memory.
3. Highlight the desired route and press MENU to display the Route Options.
4. Highlight 'Activate' and press ENTER to navigate the route in sequence.

To deactivate the route and stop using it for navigation:

1. Press PAGE repeatedly to display the Active Route Page. (See page 66.)
2. Press MENU to display the Active Route Options.
3. Highlight 'Deactivate' and press ENTER to stop navigating the currently selected route.

The Route List also allows you to enter your own 13-character name for any listed route. By default the name includes the first and last waypoints in the route.

To enter a custom route name:

1. Press MENU twice to display the Main Menu.
2. Highlight 'Routes' and press ENTER. The Route List is displayed, showing all routes stored in memory.

3. Highlight the desired route and press ENTER to display the Route Plan Page.
4. Highlight the name field and press ENTER to begin editing.
5. Use the rocker keypad to enter the desired name and press ENTER when finished.

Route Editing

Once a route is added to memory you can review and/or edit the route from the Route Plan Page. The Route Plan Page shows the sequence of waypoints for the selected route and provides additional options to depict the route layout on the map display, insert waypoints, remove waypoints or perform trip/fuel planning functions.

To edit a route:

1. From the Route List, highlight the route you wish to edit and press ENTER. The Route Plan Page appears for the selected route.
2. To change a route waypoint, highlight the waypoint you wish to change and press ENTER. Use the rocker keypad to enter the new waypoint and press ENTER.
3. To review the information for a route waypoint, highlight the desired waypoint and press MENU. A pop-up menu appears with additional options. Highlight 'Review Wpt' and press ENTER to display information for the selected waypoint.
4. To insert a waypoint in the route, highlight the waypoint that will immediately follow the new route waypoint and press MENU. A pop-up menu appears with additional options. Highlight 'Insert Wpt' and press ENTER to display a blank line for the new waypoint. Enter the name of the new waypoint, using the rocker keypad, and press ENTER.
5. To delete a waypoint from the route, highlight the waypoint you wish to delete and press MENU. A pop-up menu appears with additional options. Highlight 'Remove Wpt' and press ENTER.



The Route Plan Page allows for easy editing of an existing route.

CABIN-RIDGE		Route Plan
Waypoint	Distance	
CABIN	0.00 ^m	
STAND1	3.20 ^m	
STAND2	5.84 ^m	
RIDGE	10.3 ^m	
-----	----- ^m	TOTAL
		10.3 ^m

To edit the route, highlight the route waypoint which is affected by the change. If inserting a waypoint, highlight the waypoint which follows the new waypoint.

REFERENCE

Route Editing / Planning

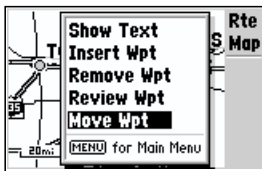

The 'Show Map' option allows you to change the route from the map display. Place the arrow on the point affected by the change and press MENU to display editing options.

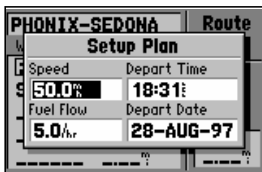

With the Route Plan Page displayed, use the LEFT/RIGHT keys on the rocker keypad to select the trip planning features. Press MENU and select 'Setup Plan' to define departure time, fuel usage and speed.

6. To edit the route from the map display, press MENU from the Route Plan Page. Highlight 'Show Map' and press ENTER. Use the rocker keypad to place the cursor on the desired waypoint and press MENU. A pop-up menu appears. Select the desired option and press ENTER. If 'Move' is selected, move the cursor to the desired location and press ENTER to accept the change.

Route Planning

The Route Plan Page also displays trip planning information for each leg of the entire route. Available information includes desired course, time to waypoint, distance to waypoint, required fuel and sunrise/sunset times at the waypoint location.

To use the trip planning features:

1. To select the desired planning figure, highlight the desired route from the Route List and press ENTER to display the Route Plan Page. One of ten available planning figures appears to the right of each route waypoint. Use the LEFT/RIGHT keys on the rocker keypad to select the desired item.
2. To enter planning information, Press MENU and select 'Setup Plan' from the options list. Enter the figures for speed, fuel flow, departure time and departure date. Press QUIT to return to the Route Plan Page.



NOTE: Fuel flow rates on your GPS III+ are measured in "units per hour". System setting changes for units of measure (statute, nautical or metric) do not affect the fuel flow measure. You should enter fuel flow rates based upon available information for your vehicle (operator's manual, performance specifications, etc.) and make note of the desired units of measure (gallons, liters, etc.)

When a route is highlighted on the Route List, additional functions are available from the Route Options.

To display the Route Options, press MENU (with the Route List displayed).

The following options are available:

New Route— allows you to create a new route, as described on page 60.

Activate Route— allows you to navigate the route in the same sequence it was originally created, as described on page 62.

Copy— allows you to copy the selected route to a new route. The copy function can be used to save a TracBack route for future use. The copy function is also useful for duplicating an existing route before making changes.

To copy a route:

1. Highlight the desired route on the Route List and press MENU.
2. Highlight 'Copy' and press ENTER.
3. The Route Plan Page will appear for the duplicate route and the name for the new route will be identical to the original, but followed by a number (e.g. 'HOME-CAMP 1').

Delete Route— allows you to remove the selected route from memory. The waypoints contained in the route will still appear in memory, but not as part of the route.

To delete a route from memory:

1. Highlight the desired route on the Route List and press MENU.
2. Highlight 'Delete Route' and press ENTER. A confirmation page will appear.
3. Press ENTER to delete the route (or QUIT to cancel).



'Copy' allows you to make a duplicate of a route before making editing changes.



'Delete' will remove the selected route from memory, but not the waypoints contained in the route.

REFERENCE

Route Options / Active Route

CABIN-RIDGE		Active Route
Waypoint	Distance	
CABIN	---	
▶STAND1	3.19 ^m	
STAND2	5.52 ^m	
RIDGE	9.36 ^m	
-----	---	
	TOTAL 9.36 ^m	

The Active Route Page shows the route currently being used for navigation guidance. The next waypoint in the route is denoted by an arrow on the left-hand side of the screen.



Selecting a GOTO destination along the current route will take you directly to that waypoint, then continue with the remainder of the route.

Delete All— allows you to remove all routes from memory. The waypoints contained in all stored routes will remain in memory, but not as part of any route.

To delete all routes from memory:

1. Highlight 'Delete All' and press ENTER. A confirmation page will appear.
2. Press ENTER to delete all routes (or QUIT to cancel).

Active Route Page

The last page appearing in the main sequence (using the PAGE or QUIT keys) is the Active Route Page. Whenever you have activated a route, GOTO, MOB or TracBack, the Active Route Page will show each waypoint (by name) of the active route, along with the desired course, distance to waypoint, time to each waypoint, fuel requirements or sunrise/sunset times at each route waypoint. As you navigate the route, the information on the Active Route Page will automatically update to indicate the destination waypoint and any remaining interim waypoints—with the next point along the route denoted by an arrow on the left-hand side of the screen.

From the Active Route Page you can change the name of the active route (see page 62), review information on a route waypoint (see page 47) or bypass route waypoints and GOTO any waypoint in the route (see page 56). The user-selectable data field on the right side of the page also keeps you informed of current conditions. There are ten different data items available. See page 95 for data type descriptions.

To change the Active Route Page data, press the LEFT/RIGHT keys on the rocker keypad.

Active Route Page Options

Many features of the GPS III+ are menu driven. Each of the main pages has an options menu, allowing you to custom tailor the corresponding page to your preferences and/or select special features which specifically relate to that page.

To display the Active Route Page Options, press MENU (with the Active Route Page displayed).

The following options are available:

Show Map— allows you to view the area around the active route. When selected, 'Show Map' will show the map display centered around the first waypoint in the active route.

Setup Plan— displays a trip planning screen, allowing you to plan and review distance, fuel, time en route and sunrise/sunset information for the selected route.

To use the trip planning features:

1. Highlight 'Setup Plan' and press ENTER. The trip planning screen is displayed, showing speed, fuel flow, departure time and departure date information.
2. Enter an hourly fuel flow (if desired) in the fuel field, using the same steps above. Fuel flow rate units (gallons, liters, etc.) are not specified on the GPS III+. Enter these figures based upon available information for your vehicle and make note of the desired units.
3. Press QUIT to return to the Route Plan Page, then use the LEFT/RIGHT keys on the rocker keypad to review the planning information.

Re-evaluate— reactivates the current route and selects the route leg closest to your current position as the active leg. The active leg defines the current 'from' and 'to' waypoints.

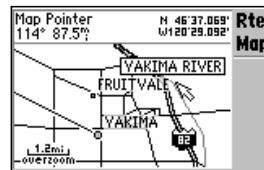

To view each waypoint along your route and the surrounding area, select 'Show Map' and use the panning arrow to move along your route on the map display.



'Setup Plan' allows you to define planned speed, fuel flow and departure time in order to review trip planning figures.

REFERENCE

Active Route Page Options



'Re-evaluate' will reactivate the current route and select the closest leg. This feature is handy if you stray well off course and later wish to return to the route.



To reverse the sequence of waypoints in the active route, select the 'Invert' option.

Deactivate— cancels navigation of the route you are currently using. See page 62.

Invert— reactivates the current route in reverse order and navigates from the end waypoint back to the beginning waypoint. See page 62.

Insert Wpt— allows you to insert an additional waypoint into the route, directly in front of the currently highlighted waypoint in the route. If no route waypoint is highlighted, this option is not available. See page 63 for route editing info.

Remove Wpt— removes the currently highlighted waypoint from the route. If no waypoint is highlighted, this option is not available. See page 63 for route editing information.

Review Wpt— allows you to view information for the currently highlighted waypoint in the route. If no route waypoint is highlighted, this option is not available. See page 53 for waypoint review information.

Delete Route— allows you to remove the current route from memory. The waypoints contained in the route will still appear in memory, but not as part of the route. See page 65.

The GPS III+'s Main Menu provides access to the waypoint, route, track log, timer and setup features of the receiver. The Main Menu can be accessed at any time using the MENU key.

To display the Main Menu, press the MENU key twice.

The 7 menu options are divided into categories by function: waypoints/cities/nearest locations, routes/track logs, trip computer, and system setups.

To select an option from the Main Menu, highlight the desired item and press ENTER.

The following menu options are available (continued on the next five pages):

Waypoints— allows you to create, edit or delete waypoints. See pages 47-52.

Cities— allows you to search the built-in database for a particular city or town. The City Spell 'n Find Page will display the location, size/reference, bearing and distance to the selected city. (Categories for small towns and small/medium/large cities are provided, based on the population levels described on page 70.)

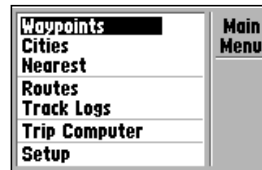

Press MENU twice to display the Main Menu.

City Spell 'n Find

To select a city and display it on the City Spell 'n Find Page:

1. Highlight 'Cities' from the Main Menu and press ENTER.
2. The first character of the city name field should already be highlighted. Enter the name of the desired city using the ROCKER KEYPAD—UP/DOWN to change the highlighted character, and RIGHT to move to the next character. As you spell the name of the desired city, the GPS III+ will display the first entry in the built-in database which corresponds to the characters you have entered. If duplicate entries exist for the desired city, continue scrolling through the database entries using the UP/DOWN keys on the ROCKER KEYPAD. (When the same city name exists in several states/countries, pay particular attention to the 'State/Country' field directly below the city name field.)
3. Once the desired city is displayed, press ENTER to accept the selection.

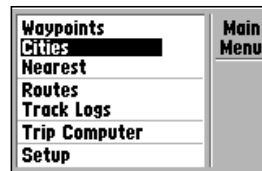

Select the desired menu option by highlighting it with the rocker keypad and pressing ENTER.

REFERENCE

Main Menu: City Options

City Spell 'n Find	
ATLANTA	Done
State/Country	Reference
Georgia	-----
USA	Bearing
Position	106°
N 33°45.824'	Distance
W084°25.302'	567.5'

The City Spell 'n Find Page lets you retrieve information for any city in the built-in database.



The 'Show Map' Option allows you to view the area around the city location. Use the IN and OUT zoom keys to view the desired detail.

City Spell 'n Find Options

To view the City Spell 'n Find Options, press MENU (with the City Spell 'n Find Page displayed).

The following options are available:

Show Map allows you to view the map area surrounding the selected city's position. While viewing the map display, you can also use the IN and OUT zoom keys to see additional detail.

To view the map area around the city location:

1. Select 'Show Map' and press ENTER.

Save As Waypnt creates a waypoint at the city location and saves it in memory. If the city name is longer than six characters, it will be abbreviated when creating the waypoint.

To save an exit location as a waypoint:

1. Select 'Save As Waypnt' and press ENTER.
2. With 'Done' highlighted, press ENTER to save the new waypoint.

Show Reference / Show City Size allows you to toggle between a reference waypoint field or size information. The reference waypoint field allows you to determine bearing and distance from any waypoint to the selected city. The size information block describes the size of the selected city as follows: Large cities are those with approximate populations greater than 200,000. Medium cities are greater than 50,000 and small cities are greater than 5,000. Small towns include those with approximate populations under 5,000 or towns of unknown size.



NOTE: When the 'Reference' field is left blank or the size information field is displayed, the 'Bearing' and 'Distance' information provided is from your current position.

City Spell 'n Find Options (cont.)

To select between size information and a reference waypoint field:

1. Select 'Show City Size' or 'Show Reference' (as appropriate) and press ENTER. (When one of the options is selected, the other option will appear on the City Spell 'n Find Options menu.)
2. If 'Show Reference' is selected, the City Spell 'n Find Page will reappear.

To enter a reference waypoint and display the bearing and distance from the waypoint to the selected city:

1. Select the 'Show Reference' option, as described above.
2. With the cursor highlighting the reference waypoint field, press ENTER to begin entering the reference waypoint name.
3. Use the **ROCKER KEYPAD** to enter the name of the reference waypoint and press ENTER when finished. The bearing and distance from the reference waypoint to the city location will appear at the bottom right corner of the screen.

Nearest— displays up to nine nearest waypoints and 50 nearest cities within 200 miles of your present position, along with 50 exits on the nearest interstate highway. See page 53.

Routes— allows you to create, edit, activate or delete routes. See pages 60-64.

Track Log— lets you specify whether or not to record a track log (an electronic 'breadcrumb trail' recording of your path), define how it is recorded or save track log data for future use. The Track Logs Page also provides an indicator of the memory used for the active track log and options to clear the track memory or start a TracBack route. See pages 58-59 for TracBack information.

The Track Logs Page is divided in two main sections: one for the active log (the log currently being recorded) and available memory, and the second section showing any saved track logs and the total number saved. The active log stores up to 1900 track log positions, based upon the criteria specified in the Track Log Options. Up to 10 additional track logs may be saved in memory, with up to 250 track log positions in each saved log. You may also choose to display/not display the saved log.

City Spell 'n Find	
Atlanta	Done
State/Country	Reference
Georgia	NEWMAN
USA	Bearing
Position	038°
N 33°45.824'	Distance
W084°25.302'	33.86"

'Show Reference' allows you to display bearing and distance (from any waypoint you have stored in memory) to the selected city.

City Spell 'n Find	
Atlanta	Done
State/Country	Reference
Georgia	-----
USA	Bearing
Position	332°
N 33°45.824'	Distance
W084°25.302'	23.04"

To clear the reference field (and use your present position instead) press LEFT side of the **ROCKER KEYPAD** until the reference waypoint field becomes blank, then press ENTER.

REFERENCE

Main Menu: Track Logs

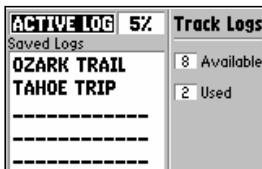

The Track Logs Page shows available memory for the active log (the log currently being recorded) and lists any saved track logs.



From the Track Logs Page, press MENU to view the Track Log Options.

Track Log Settings

To view the Track Log Options, highlight 'Active Log' or any of the 'Saved Logs' (on the Track Logs Page) and press MENU.

The following options are available:

TracBack converts the track log data in memory into an inverted route (of up to 30 waypoints) and begins navigation along the route. See pages 58-59.

Save Active Log extracts up to 250 of the most significant points along the active log, saves this information as a 'saved log', and clears the active log. Up to 10 saved logs may be stored in memory, along with a 13-character name. The default name is the date the log was saved, but you can specify any name you wish.

To rename a saved log:

1. Highlight the saved log you wish to rename and press ENTER. An information box appears, showing the name of the saved log, the number of points in the track log and the total distance covered.
2. Highlight the track log name field and press ENTER.
3. Use the rocker keypad to enter the new name for the saved log. Press ENTER when finished.

Clear Active Log / Delete Saved Log clears the selected track log, active or saved, from memory. Highlight the 'Active Log' to display the 'Clear Active Log' option, or highlight any of the 'Saved Logs' to display the 'Delete Saved Log' option. You should select the 'Clear Active Log' option at the beginning of any trip where you'll want to convert the track log data into a TracBack route. See pages 58-59.

To delete a track log:

1. Highlight the track log you wish to delete (active or saved) on the Track Logs Page, and press MENU to display the Track Log Options.
2. Highlight 'Clear Active Log' or 'Delete Saved Log' and press ENTER.
3. Press ENTER again to confirm (or press QUIT to cancel).

Track Log Settings (cont.)

Delete All allows you to clear all track logs, active and saved, from memory.

To delete all track logs from memory:

1. Select 'Delete All' from the Track Log Options and press ENTER.
2. Press ENTER again to confirm (or QUIT to cancel).

Setup Logging provides a setup screen to define how track log data will be recorded. The Setup Logging Page provides options for 'Record Mode', 'Interval' and 'Interval Value'.

Record Mode lets you select one of three track recording options:

'Off' – No track log will be recorded.



NOTE: Selecting 'Off' may prevent you from using the TracBack feature.

'Fill' – A track log will be recorded until the track memory is full.

'Wrap' (default) – A track log will be continuously recorded, wrapping through available memory; replacing the oldest track data with new data.

Interval defines the frequency with which the track plot is recorded. Three interval settings are available:

'Resolution' (default) – Records track log based upon a user-defined variance from your course over ground. The resolution option is recommended for the most efficient use of memory and TracBack performance. The distance value (entered in the 'Interval Value' field) is the maximum left/right deviation allowed from the last defined ground track before recording a new point.

'Time' – Records track log based on a user-defined time interval.

'Distance' – Records track log based on a user-defined distance between points.

Interval Value defines the distance or time interval used to record the track log.



Select 'Save Active Log' to save the active log data for future use. This process extracts the most significant points along the active route (up to 250) and creates a 'saved log'.



The 'Setup Logging' option allows you to change the criteria used to record the active track log.

REFERENCE

Main Menu / Setup Menu

Trip Computer	
Trip Odometer	Average Speed
0.00 ^m	0.0 ^k
Trip Timer	Maximum Speed
00:00:00	0.0 ^k
Odometer	
	0 ^m

'Trip Computer' provides readouts for the trip odometer, trip timer, average speed and maximum speed. Options are provided to reset these figures.

Simulator	System	Units	Time
Mode		Speed	
Simulator On		0.0 ^k	
Track Control		Track	
Auto Track		225 ^k	
Altitude			
1252 ^k			

The 'Setup' option uses file tabs (across the top of the page) for quick selection/ review of unit settings.

Track Log Settings (cont.)

Displayed on Map/Not Displayed— allows you to control if a saved track log is displayed on the map page.

To display/not display a saved track log:

1. Highlight a saved track log from the Track Logs list and press ENTER. This will display the details of the saved track log. (You may also change the name of the track log or start a TracBack from this page.)
2. Press MENU, then with Display Options highlighted, press ENTER. Choose the desired display option and press ENTER.

Trip Computer— provides readouts for average speed, maximum speed, odometer, trip odometer and trip timer. These readouts can be reset from the Trip Computer Options.

To reset a trip computer readout(s):

1. Press MENU (with the Trip Computer Page displayed). An options list is displayed.
2. To reset all trip computer readouts, highlight 'Reset All' and press ENTER.
3. To reset a single readout item, highlight the desired option and press ENTER.
4. To log trip time only while moving, highlight 'Use Time Moving' and press ENTER. If this option is selected, 'Use Total Time' will appear instead. This latter option logs trip time any time the GPS III+ is on and has a position fix.

NOTE: The 'Reset Trip' option resets trip odometer, trip timer and average speed readouts.

Setup— provides a group of pages to perform various system setup functions, including selection of position format, units of measure, setting various alarms, configuring the display orientation and backlighting. Each available page is denoted by a 'file tab' which identifies the function of that page.

REFERENCE

Setup Menu

To select a Setup option, highlight the file tab for the desired function. The information is automatically displayed when the file tab is highlighted.

The file tab headings and setup functions for these pages are:

Simulator	Enable/Disable; Settings for simulated Track, Speed and Altitude
System	Backlight timeout, Battery type, Power Saver Mode and Display Orientation
Units	Units of measure settings for – Distance & Speed, Heading and Altitude
Timers	Count up/down User Timer, Battery Timer, and usage timers for current day and since new
Time	Formats for local 24 hour, local 12 hour (AM/PM) or UTC; Difference setting from UTC to local time
Alarms	Alarm Clock, Arrival Alarm, Off Course Alarm
Position	Position Format (latitude/longitude, UTM/UPS, Maidenhead, regional grids); Map Datum selection
Interface	Format (NMEA, RTCM, GARMIN proprietary); Mode setting for use with PC or a second unit

The following pages describe, in more detail, the available settings for each Setup file tab item.

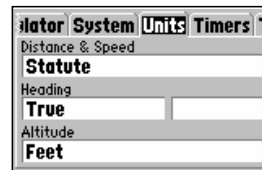

To display the desired information, highlight the appropriate file tab (using the LEFT/RIGHT keys on the rocker keypad).

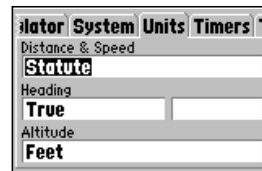

Once the desired tab is selected, use the UP/ DOWN keys on the rocker keypad to select the desired item on the page.

REFERENCE

Setup Menu: Simulator

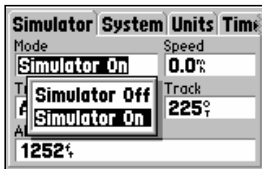

'Simulator' allows you to configure the built-in simulator feature.

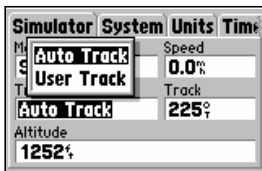

The 'Track Control' setting allows the simulator to automatically "line up" on the correct bearing to a destination waypoint.

Simulator Settings

Mode lets you turn the built-in simulator on or off.

To enable/disable the built-in simulator:

1. Highlight the 'Mode' field and press ENTER.
2. Select 'Simulator Off' or 'Simulator On' (as desired) and press ENTER.

Speed lets you select a simulated speed when the simulator is enabled.

Track Control allows the built-in simulator to automatically align track heading to the desired course (when using a GOTO or route), or allows you to manually adjust the track heading, as desired.

Track allows you to manually enter a track heading. This setting is only available when Track Control is set to 'User Track'.

Altitude allows you to specify a user-defined altitude for your simulated position.

To select a simulator setting:

1. For track control, highlight the 'Track Control' field and press ENTER. Select 'Auto Track' or 'User Track' and press ENTER.
2. For simulated speed, user track, or altitude, highlight the desired field and press ENTER. Enter the desired value using the rocker keypad and press ENTER when finished.

System Settings

Backlight lets you keep the screen/keypad backlighting on continuously ('always on') when selected, or enable the automatic shutoff to preserve battery life. Automatic shutoff times from 15 seconds to 4 minutes (since last key press) are available.

To set the backlight timeout:

1. Highlight the 'Backlight' field and press ENTER.
2. To keep backlighting on continuously, select 'Always On' and press ENTER, **OR**
3. To set a timeout duration, select the desired time period and press ENTER.

Battery is used to designate the type of batteries currently being used to power your GPS III+: Alkaline, Lithium or NiCad. This setting ensures accurate readings from the battery gauge on the Satellite Status Page (see page 27).

Power Saver is suitable for most applications and offers position updates which adapt to your needs while extending battery life. The GPS III+ will operate up to 36 hours when using Power Saver mode.

To select power saver mode:

1. Highlight the 'Power Saver' field and press ENTER.
2. Use the UP/DOWN keys on the **ROCKER KEYPAD** to select 'ON' (or 'OFF') and press ENTER.

Display allows you set the display orientation to horizontal ('Landscape') or vertical ('Portrait').



NOTE: Display orientation can also be changed by pressing and holding the PAGE key.



Set the 'Backlight' field to 'Always On' to prevent the backlighting from timing out and turning off automatically.

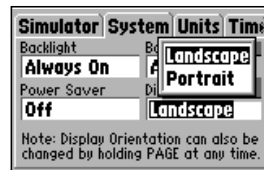

Display orientation is adjustable by pressing and holding the PAGE key, or from the 'System' settings.

REFERENCE

Setup Menu: Units

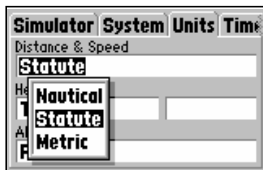

Select nautical, statute or metric units of measure from the 'Units' settings.

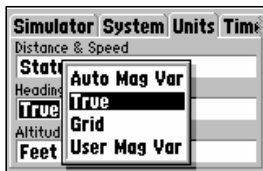

The 'User Mag' option allows you to define the magnetic variation for your area. 'Auto Mag Var' is the preferred setting in most cases.

Units Settings

Distance & Speed lets you select the desired units of measure for distance and speed readouts in 'Nautical', 'Statute' or 'Metric' terms.

Heading lets you select the reference used in calculating heading information. You can select from 'Auto Mag Var', 'True', 'Grid' and 'User Mag Var'. 'Auto Mag Var' provides magnetic north heading references which are automatically determined from your current position. 'True' provides headings based upon a true north reference. 'Grid' provides headings based on a grid north reference (and is used in conjunction with the grid position formats described on page 82). 'User Mag Var' allows you to specify the magnetic variation at your current position and provides magnetic north heading references based upon the variation you enter.

Altitude lets you select altitude readouts in 'Feet' or 'Meters'.

To select a units setting:

1. Highlight the desired field and press ENTER to display the available options.
2. Select the desired option and press ENTER.
3. If 'User Mag Var' is selected in the 'Heading' field, highlight the heading reference field (immediately to the right) and press ENTER. Enter the magnetic variation at your current position using the rocker keypad and press ENTER.



WARNING: If 'User Mag Var' is selected, you must periodically update the magnetic variation as your position changes. Using this setting, the GPS III+ will not automatically calculate and update the magnetic variation at your present position. Failure to update this setting may result in substantial differences between the information displayed on your GPS III+ and external references, such as a magnetic compass.

Timers Settings

User Timer lets you select a count up or count down timer. For a count down timer you may also specify the count down duration.

To select a user timer setting:

1. For a count down timer, highlight the 'User Timer' field in the right-hand column, press ENTER and enter the count duration using the rocker keypad. Press ENTER to accept, then—with the left-hand column highlighted—press ENTER to view the User Timer options. Select 'Down' and press ENTER.
2. For a count up timer, highlight the 'User Timer' field in the left-hand column, press ENTER and select 'Up'. Press ENTER to confirm.
3. To reset the timer or turn the timer off, highlight the 'User Timer' field in the left-hand column, press ENTER and select 'Reset' or 'Off' (as appropriate). Press ENTER to confirm.

Battery Timer provides a running count of how long the GPS III+ has been in operation with the current batteries. The timer automatically stops when using an external power source. The timer will automatically reset when depleted batteries are replaced, but can also be manually reset.

To select a battery timer setting:

1. Highlight the 'Battery Timer' field in the left-hand column and press ENTER.
2. Select 'Off', 'On' or 'Reset' (as appropriate) and press ENTER.

Since Midnight provides a running count of how long the GPS III+ has been in operation since midnight of the current day.

Since Factory Reset provides a running count of total GPS III+ operating time since the receiver was shipped from the factory.



The 'User Timer' option provides both count up and count down timers.



The battery timer will automatically reset when depleted batteries are replaced with a fresh set.

REFERENCE

Setup Menu: Time

System	Units	Timers	Time	£
Time Format				
Local 24hr				
Local Time Zone				
05:00		Behind UTC		
Time		Date		
11:00:34		29-AUG-97		

Enter an offset amount to adjust the time display to your local area. In the United States, all offset amounts will be 'Behind UTC'.

System	Units	Timers	Time	£
Time Format				
Local 24hr				
Local Time Zone				
Local 24hr		Behind UTC		
Local 12hr		date		
UTC		29-AUG-97		

If you're unsure of the exact offset, select a 'Local' time format, then enter offset values until you arrive at the correct local time.

Time Settings

Time Format allows current time to be displayed using a 12- or 24- hour clock. This field is also used to select between local and UTC time readouts.

To select a time format:

1. Highlight the 'Time Format' field and press ENTER to display the available options.
2. Select 'Local 24hr' or 'Local 12hr' to display local time references. 'Local 12hr' will show current time using a traditional AM/PM format, **OR**
3. Select 'UTC' to display universal time references (also referred to as 'Greenwich' or 'zulu' time).

Local Time Zone is used to define the current local time. UTC (also called Greenwich time) date and time are calculated directly from the satellites' signals and cannot be edited. If you prefer to use local time, you may designate an offset, either 'Behind UTC' or 'Ahead of UTC'. The offset is the difference, in hours and minutes, between local time and UTC time. See the table on page 97 for time offsets.

To enter the local time zone:

1. Highlight the 'Local Time Zone' field and press ENTER.
2. Select the desired offset amount (in hours and minutes) using the rocker keypad and press ENTER.
3. Highlight the offset direction field (immediately to the right) and press ENTER.
4. Select 'Behind UTC' or 'Ahead of UTC' (as appropriate) and press ENTER.

Time displays the current time based on the settings made above and information provided by the satellites received.

Date displays the current date based on the settings made above and information provided by the satellites received.

Alarms Settings

Clock Alarm uses the internal clock to provide an 'Alarm Clock' message at the time you set.

To enable/disable the alarm clock:

1. Highlight the 'Clock Alarm' field and press ENTER.
2. Select 'On' or 'Off' (as desired) and press ENTER.
3. If enabling the alarm, highlight the time field (to the immediate right) and press ENTER. Enter the alarm time using the rocker keypad and press ENTER.



NOTE: The GPS III+ must be turned on when the alarm time is reached. Otherwise, the message will not occur.

Arrival Alarm provides an alarm message once you're within a set distance from your destination waypoint. As you approach the destination waypoint, an 'Arrival at ____' message occurs when you are within the alarm distance you entered.

Off Course Alarm provides an alarm message ('Off Course Alarm') when you deviate off course beyond the specified limits.

To set the arrival and/or off course alarms:

1. Highlight the 'Arrival Alarm' or 'Off Course Alarm' field and press ENTER.
2. Select 'On' or 'Off' (as desired) and press ENTER.
3. If enabling the alarm, highlight the alarm distance field (to the immediate right) and press ENTER. Enter the alarm distance using the rocker keypad and press ENTER.

Units	Timers	Time	Alarms	F
Clock Alarm				
Off		00:00:		
Arrival Alarm				
On		02.00:		
Off Course Alarm				
Off		0.00:		

An 'Approaching' message automatically appears one minute before reaching the destination waypoint. The arrival alarm allows you to set a distance-defined message.

Units	Timers	Time	Alarms	F
Clock Alarm				
Off		00:00:		
Off		Alarm	0.00:	
On		Off Course Alarm	0.50:	

The 'Off Course Alarm' provides an alert if you drift off course beyond the limits you have set.

REFERENCE

Setup Menu: Position



Only the latitude/longitude, UTM/UPS and Maidenhead settings apply worldwide. The additional grid settings are only valid for a specific region.



Datums are used to describe geographic positions for surveying, mapping, and navigation and are not actual maps built in the unit. Use WGS 84 unless your chart specifies otherwise.

Position Settings

Position Format is used to change the coordinate system in which a given position reading is displayed. The default format is latitude and longitude in degrees and minutes (hddd°mm.mmm'). The following additional formats are available:

- hddd.dddd° — latitude/longitude in decimal degrees only
- hddd°mm.mmm' — latitude/longitude in degrees, minutes, seconds
- UTM/UPS — Universal Transverse Mercator / Universal Polar Stereographic grids
- MGRS — Military Grid Reference System
- British Grid
- Maidenhead
- Swiss Grid
- Loran TD (See following page.)
- German Grid
- New Zealand
- Taiwan Grid
- Irish Grid
- Swedish Grid
- User UTM Grid

Map Datum allows you to select the datum reference used to determine where a given position is. The default setting is 'WGS 84'. Although over 100 datums are available (as listed on page 92-94), you should only change the datum if you are using a map or chart that specifies a different datum. Make sure the settings under the 'Position' tab of the III+ match that of the map or chart. This information should be displayed somewhere on the map or chart. If the information is not present, contact the map or chart maker to determine what position format, datum, heading and units of measure are being used for the map or chart.

WARNING: Selecting the wrong map datum can result in substantial position errors. When in doubt, seek assistance or use the default WGS 84 datum for best overall performance.

To change the position format and/or map datum:

1. Highlight the 'Position Format' or 'Map Datum' field and press ENTER.
2. Select the desired setting (using the rocker keypad) and press ENTER.

Setup Menu: Loran TD

Loran TD Setup Page

LORAN TD Feature

The LORAN TD (Time Delay) feature eases the transition from using LORAN to using GPS. The III+ unit automatically converts GPS coordinates to LORAN TDs for those who have a collection of LORAN fixes for favorite fishing spots and other waypoints recorded as TDs. You can display your position as a TD or enter waypoints as TDs. The accuracy to be expected from this conversion is approximately thirty meters. When the unit is placed in the LORAN TD format mode, it simulates the operation of a LORAN receiver. Position coordinates may be displayed as TDs, and all navigation functions may be used as if the unit was actually receiving LORAN signals.

Using the LORAN TD Format

When creating new waypoints using LORAN TD coordinates you must set the correct LORAN chain number and secondary stations in the Setup TD field before storing the waypoint. After the waypoint is stored in unit memory, it will always reference the LORAN chain number and secondary stations currently selected in the Setup TD field. If you enter a different LORAN chain number, change the secondary stations or offsets in the Setup TD field, the active waypoint information will reflect those changes. Since the III+ does not rely on the LORAN signal for navigation, it can reference a different GRI chain and/or secondary stations and still navigate to the location stored in memory.

The LORAN Position Format field is located under the Position tab in the Main Menu. The 'LORAN TD Setup' window contains the fields where the Loran GRI-Chain Number, Primary & Secondary Stations and TD Offsets are selected.

To setup Loran TD from the Main Menu:

1. With the Position Format set to 'Loran TD', press MENU
2. Highlight 'Setup Loran TD', press ENTER/MARK
3. To change the settings of any of the five fields, highlight the field, press ENTER/MARK, select/enter the desired setting and press ENTER/MARK.
4. When done, highlight 'Save' and press ENTER/MARK.

Selecting the Loran Chain Number

Setup Menu: Interface

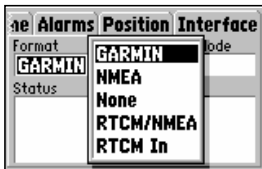

The 'GARMIN' option allows the GPS III+ to exchange data with a PC or another GPS III+. Use this setting with the optional PC Software Kit.

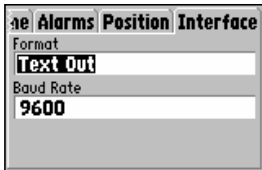

Select the 'Text Out' option to output simple text (ASCII). For additional details on this format, please visit the GARMIN web site.

Interface Settings

Format lets you control the input/output format used when connecting your GPS III+ to external NMEA devices, a DGPS beacon receiver, a personal computer, etc. Five format settings are available:

- GARMIN — the proprietary format used to upload/download MapSource data, exchange waypoint, route, track log data with a PC or with another GPS III+.
- GRMN DGPS — used to connect the III+ with a GARMIN DGPS beacon receiver
- NMEA — supports the input/output of standard NMEA 0183 version 2.0 data.
- None — provides no interfacing capabilities.
- RTCM/NMEA — allows Differential GPS (DGPS) input using a standard RTCM format and also provides NMEA 0183 version 2.0 output.
- RTCM/Text — allows DGPS input using a standard RTCM format and also provides simple text (ASCII) output which contains time, position and velocity data.
- Text Out — outputs simple text (ASCII) which contains time, position and velocity.

To select an input/output format:

1. Highlight the 'Format' field and press ENTER.
2. Select the desired setting and press ENTER.
3. If the 'GARMIN' format is selected, highlight the 'Transfer Mode' field and press ENTER. Select the desired setting and press ENTER. The 'Transfer Mode' field allows you to specify what information to request or send to a second GARMIN GPS III+. The 'Host' setting lets you control all data transfer functions from the second GPS III or from a PC. Set to 'Host' when using the III+ with MapSource.
4. If an 'RTCM' format is selected, additional fields are provided to control a GARMIN differential beacon receiver (e.g. GBR 21/23) directly from your GPS III+. The unit will automatically scan for a frequency, or you can manually enter the beacon frequency and bit rate. For more information, refer to the owner's manual for your GARMIN differential beacon receiver.

To have the unit automatically scan for a frequency:

1. With the unit set to 'Garmin DGPS' or 'RTCM/NMEA', use the ARROW KEYPAD to highlight the 'Tuning Mode' field and press ENTER/MARK.
2. Highlight 'Scan' and press ENTER/MARK. The numbers in the 'Beacon' field will change as the unit scans from 284 kHz to 325 kHz, 200 bit rate, then 100, at 6-second intervals.

To restart the scan:

1. Press MENU, highlight 'Restart Scan' and press ENTER/MARK.

To manually enter a frequency and bit rate:

1. With the unit set to 'Garmin DGPS' or 'RTCM/NMEA', use the ARROW KEYPAD to highlight the 'Beacon' field and press ENTER/MARK.
2. Highlight 'User' and press ENTER/MARK.
3. Highlight the 'Beacon' or 'Bit Rate' field, press ENTER/MARK, then enter a frequency or bit rate and press ENTER/MARK when done.

The "Status" field will show one of the following:

- Tuning— unit is attempting to tune to the specified frequency and bit rate.
- Scanning— unit is automatically scanning through the frequencies and bit rates.
- Receiving— unit is receiving DGPS signal and ready for operation.
- Check Wiring— unit is not making connection with DGPS receiver.

When the unit is receiving a DGPS signal, the "SNR" (Signal to Noise Ratio) and "Distance" fields will show data. The SNR range is 0dB to 30dB, with 30 being the best. The Distance may or may not show data, depending upon the signal being broadcast from the DGPS site.

The DGPS beacon transmitters are operated by the U.S. Coast Guard (or similar government agency in other countries), which is responsible for their accuracy and maintenance. For DGPS transmitter problems or to find the most updated list of frequencies & coverage areas, contact your local USCG, or see their web site at <http://www.navcen.uscg.mil/>.

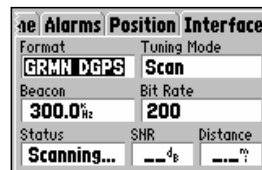

The III+ can automatically tune the GARMIN GBR 21 or GBR 23.



Press MENU to restart the scan. 'View Beacon Log' allows you to view the last 5 valid frequencies. To use a frequency from the list, highlight it and press ENTER/MARK.

APPENDIX A

Dashboard Mounting

The GPS III+ can be mounted on the dashboard of an automobile or to another convenient surface using the two Velcro™ strips provided with the unit. **Be sure to read the warnings on page ii before mounting the GPS in a vehicle!**

To mount the GPS III+ using the Velcro strips:

1. Select a location for the unit that provides a clear and unobstructed view of the sky.
2. Remove the paper strip liners from both pieces of Velcro.
3. Make sure the surface to which you're adhering the Velcro is clean and dry. Place the adhesive side of the rough piece of Velcro on the desired mounting surface, and press into place.
4. Place the adhesive side of the smooth piece of Velcro on the bottom of the unit (between the rubber anti-skid bumps), and press into place.
5. Mount the unit, placing one piece of Velcro on top of the other.

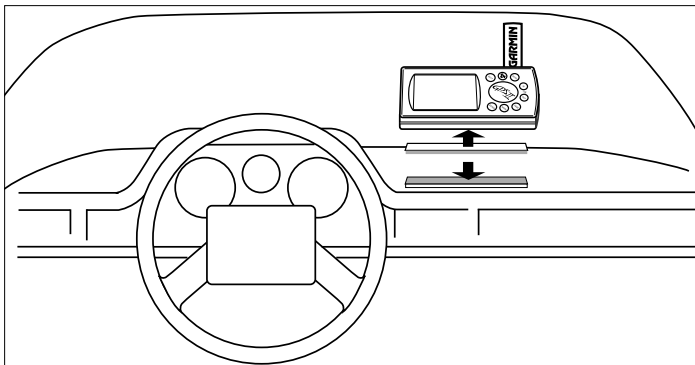

Optional Dash Mounting Bracket

An optional dash mount bracket is also available for your GPS III+. This bracket allows you to adjust the GPS III+ for best viewing angle, while installed on the dash of a vehicle. The dash mount bracket may be permanently installed or temporarily mounted using supplied Velcro fasteners.

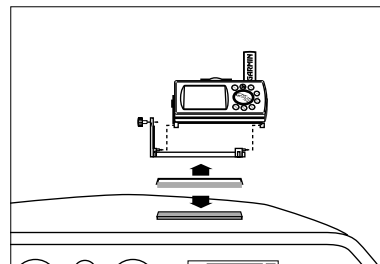

The GPS III+ is constructed of high-quality materials and should not require user maintenance. Should you ever encounter a problem with your unit, please contact your GARMIN dealer or GARMIN Customer Service. The GPS III+ has no user-serviceable parts. Never attempt any repairs yourself, as this may cause injury or void your warranty. To protect your GPS III+, keep it in its carrying case (optional accessory) when not in use, and never allow gasoline or other solvents to come into contact with the case. To clean the case and lens, use a soft cloth and a household window cleaner.

PHYSICAL

Case: Fully-gasketed, high-impact plastic alloy, waterproof to IPX7 standards

Size: 6.15"H x 2"W x 1.23"D (15.6 x 5.1 x 1.23 cm)

Weight: Approx. 9 ounces (255g) w/ batteries

Temperature Range: 5 to 158°F (-15° to 70°C)†

Memory Back Up: Internal Lithium Battery

POWER

Input: Four 1.5-volt AA batteries† or 10-32 VDC external

Power Consumption: 0.5 watts max.

Battery Life: Up to 36 hours in Power Saver mode ‡

PERFORMANCE

Receiver: Differential-ready PhaseTrac12™

Acquisition Time: Approx. 15 seconds (warm start)
Approx. 45 seconds (EZinit/cold start)
Approx. 5 minutes (AutoLocate™)

Update Rate: 1/second, continuous

Position Accuracy: 3-5 meters (10-16 ft) with DGPS corrections, 95% typical*
<15 meters (49 ft) RMS, 95% typical**

Velocity Accuracy: 0.1 knot RMS steady state

Dynamics: Performs to specification to 6 g's

Interfaces: NMEA 183, RTCM (for DGPS corrections) and RS-232 for PC interface

Antenna: Detachable with standard BNC connector

Specifications subject to change without notice.

* With optional GARMIN Differential Beacon Receiver Input (such as GARMIN GBR 21 or GBR 23).

** Subject to accuracy degradation to 100m 2DRMS under the U.S. DoD-imposed Selective Availability Program.

† The temperature rating for the GPS III+ may exceed the usable range of some batteries. Alkaline batteries can rupture at high temperatures.

‡ Alkaline batteries lose a significant amount of their capacity as temperature decreases. Use lithium batteries when operating the GPS III+ in below freezing conditions. Extensive use of screen backlighting will significantly reduce battery life.

APPENDIX C

Interfacing / Wiring



Complete information concerning NMEA & RTCM formats and sentences is available for purchase

from NMEA at:

NMEA

PO Box 3435

New Bern, NC 28564-3435

U.S.A.

252-638-2626

252-638-4885 FAX

www.nmea.org

Radio Technical Commission For
Maritime Services (RTCM)

1800 Diagonal Road, Suite 600
Alexandria, VA 22314-2480

U.S.A.

703-684-4481 (Info Only)

703-836-4229 FAX

www.rtcmm.org

Interfacing formats are selected from the Setup Menu, described on page 84. The input/output lines on your GPS III+ are RS-232 compatible allowing easy interface to a wide range of external devices, including PCs, differential beacon receivers, marine autopilots and/or a second GPS receiver.

The NMEA 0183 version 2.0 interface format is supported by the GPS III+ and enables the unit to drive up to three NMEA devices:

NMEA 0183 version 2.0 Approved sentences:

GPGGA, GPGLL, GPGSA, GPGSV, GPRMB, GPRMC, GPRTE, GPWPL, GPBOD

Proprietary sentences:

PGRME (estimated error), PGRMM (map datum), PGRMZ (altitude), PSLIB (beacon receiver control)

DGPS (Differential GPS) corrections are accepted in RTCM SC-104 version 2.0 format through the Data In line. A GARMIN Differential Beacon Receiver (such as the GBR 21 or GBR 23) is recommended for use with the GPS III+. Other beacon receivers with the correct RTCM format may be used, but may not correctly display status or allow tuning control from the GPS unit.

The GPS III+ may be hard-wired to a vehicle's electrical system (10-32 VDC) using an optional Power/Data Cable. Consult the diagram to the left for proper connections. (The male connector on the back of the GPS III+ is illustrated.) A cigarette lighter adapter is also available to power your GPS III+ without making permanent connections.

Additional cables are available for the GPS III+. Contact your GARMIN dealer or visit the GARMIN web site (www.garmin.com) for additional accessories.

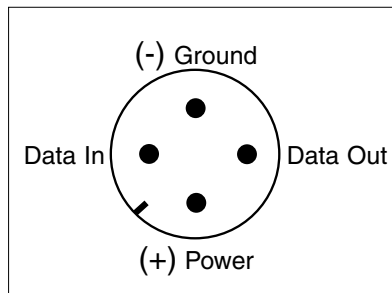

GPS III+ Connections (from back of unit)

The GPS III+'s antenna may be removed to allow attachment of an optional remote-mounted antenna. In some applications, using a remote-mounted antenna will dramatically increase the number of satellites received. The GPS antenna should be mounted in a location which provides an unobstructed view of much of the sky. A minimum of four satellites are needed to determine a three dimensional position. Satellite coverage will vary throughout the day, but may be checked at any time using the Satellite Status Page (see page 25). If satellite reception is limited in your particular installation, you may want to consider one of the following options:

Remote Suction Cup Mount – allows you to mount the standard detachable antenna up to 6 feet away from the GPS III+ unit, using a suction cup mount. This mount should only be used inside a vehicle.

GA 26C Remote Antenna – allows you to mount an amplified antenna outside the vehicle, up to 8 feet away, using supplied magnetic or suction cup mounts. An optional extension cable allows you to mount the antenna up to 16 feet away. Trunk lip and permanent flange mounts are also available.

GA 29 Remote Marine Antenna - allows you to mount an amplified antenna outside the vehicle, up to 30 feet away, using a standard 1-inch marine antenna mount (not supplied). An optional extension cable allows you to mount the antenna up to 60 feet away.

To remove the attached antenna:

1. Rotate the antenna toward the rear of the unit as shown. Note: The antenna can only be removed or installed in this position.
2. Pull the antenna gently away from the unit.
3. To install an optional external antenna, mate the BNC connector notches with the mounting posts and turn the knurled knob one-quarter turn clockwise.

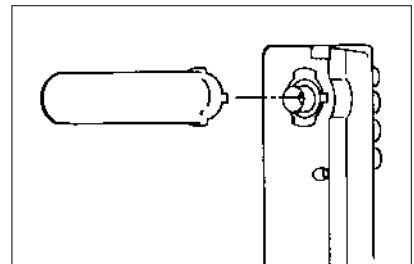

APPENDIX E

Messages

The GPS III+ uses an on-screen message indicator to alert you to important information. Whenever the message appears, press ENTER to acknowledge the message and return to the previous page you were viewing. Messages are provided for system status, waypoint/route editing, battery condition, etc. For your safety, pay careful attention to all messages.

Alarm Clock—The alarm clock time that was set from the Alarms submenu has been reached.

Approaching—You are one minute away from reaching a destination waypoint.

Arrival at—You have reached your destination waypoint.

Battery Power Low—The batteries are low and should be replaced.

Data Transfer Complete—The unit has finished uploading or downloading information to the connected device.

Degraded Accuracy—The unit's accuracy has been degraded beyond 500 meters due to poor satellite geometry or data quality. Check other navigational sources to verify the position indicated.

Leg not Smoothed—The upcoming route leg is too short for smooth waypoint transitions.

Memory Battery Power Low—The battery that sustains user memory is low and should be replaced by an authorized service center as soon as possible. Failure to do so may result in loss of stored data, including all user waypoints and routes.

Need Altitude for 2D Nav—The unit needs altitude input in order to start and/or continue 2D navigation.

Need to Select Init Method—You must select an initialization method so the unit can locate satellites and obtain a fix.

No Differential GPS Position—Not enough data is available to compute a DGPS position.

No RTCM Input—Beacon receiver is improperly connected or baud rates do not match.

Off Course Alarm—You are left or right of course, beyond the limits set on the Alarms submenu.

Oscillator Needs Adjustment—The GPS III+ has detected excessive drift in its internal crystal oscillator which may result in longer acquisition time. The unit should be taken to an authorized GARMIN service center.

Poor GPS Coverage—The unit cannot acquire the necessary number of satellites to compute a position. Try another location with a clearer view of the sky.

Power Down and Re-init—The unit cannot calculate a position due to abnormal satellite conditions. Turn power off and use other means to verify the last position shown. Try the unit again later, possibly in a different location.

RAM Failed—The GPS III+ has detected a failure in its internal memory. If the message persists, the GPS III+ is unusable and should be taken to an authorized GARMIN service center.

Received Invalid Waypoint—A waypoint was received during upload transfer that has an invalid identifier.

Receiver Failed—A failure in receiver hardware has been detected. If this message persists, do not use the unit and take it to an authorized dealer for repair.

ROM Failed—The permanent memory has failed and the unit is not operable. Take your unit to an authorized GARMIN dealer for repairs.

Route Already Exists—You have attempted to name a route with the same name currently in use with an existing route. Enter a different name for the route.

Route Full—You have attempted to add more than 30 waypoints to a route.

Route Memory Full—Route memory is full and no additional routes can be added from another GPS III+ or uploaded from a PC.

Route Waypoint Deleted—The waypoint being deleted was part of a route. The deleted waypoint is removed from waypoint memory and from the route.

RTCM Input Failed—DGPS data being received has been lost. You are no longer receiving the beacon signal.

Searching the Sky—

The GPS III+ is in searching the sky for almanac data or the unit is in AutoLocate mode.

Steep Turn Ahead—This message appears approximately one minute prior to a turn that requires a bank angle in excess of 25 degrees in order to stay on course.

Stored Data Lost—All waypoints, routes, time, and almanac data have been lost due to battery failure, or the receiver's memory has been cleared.

Timer Expired—The countdown timer has expired.

Track Log Already Exist—The name selected for the track log is identical to another track log already stored in memory.

Track Memory Full—You have used all track log points in the GPS III+. (The unit holds approximately 1900 points in the active track log.) Delete unwanted track points to make room for new entries.

Using Simulator for Faster Data Transfer—While using the PC Software Kit or the MapSource program, simulator mode is automatically selected to enable a higher data transfer rate.

Waypoint Memory Full—You have used all 500 waypoints in the GPS III+. Delete unwanted waypoints to make room for new entries.

Waypoint Already Exists—The name you are entering already exists in the GPS III+'s memory.

APPENDIX F

Map Datums

The following are the map datums available for the GPS III+. Menu Page abbreviations are listed first, followed by the corresponding map datum name and area. The default map datum for the GPS III+ is WGS 84.

Adindan	Adindan- Ethiopia, Mali, Senegal, Sudan	Cape Canavrl	Cape Canaveral- Florida, Bahama Islands
Afgooye	Afgooye- Somalia	Carthage	Carthage- Tunisia
AIN EL ABD '70	AIN EL ANBD 1970- Bahrain Island, Saudi Arabia	CH-1903	CH 1903- Switzerland
Anna 1 Ast '65	Anna 1 Astro '65- Cocos Isl.	Chatham 1971	Chatham 1971- Chatham Island (New Zealand)
ARC 1950	ARC 1950- Botswana, Lesotho, Malawi, Swaziland, Zaire, Zambia, Zimbabwe	Chua Astro	Chua Astro- Paraguay
ARC 1960	ARC 1960- Kenya, Tanzania	Corrego Alegre	Corrego Alegre-Brazil
Ascnsn Isl'd '58	Ascension Island '58- Ascension Island	Djakarta	Djakarta (Batavia)- Sumatra Island (Indonesia)
Astro B4 Sorol	Astro B4 Sorol Atoll- Tern Island	Dos 1968	Dos 1968- Gizo Island (New Georgia Islands)
Astro Bcn "E"	Astro Beacon "E"- Iwo Jima	Easter Isl'd 67	Easter Island 1967
Astro Dos 71/4	Astro Dos 71/4- St. Helena	European 1950	European 1950- Austria, Belgium, Denmark, Finland, France, Germany, Gibraltar, Greece, Italy, Luxembourg, Netherlands, Norway, Portugal, Spain, Sweden, Switzerland
Astr Stn '52	Astronomic Stn '52- Marcus Island	European 1979	European 1979- Austria, Finland, Netherlands, Norway, Spain, Sweden, Switzerland
Astrln Geod '66	Australian Geod '66- Australia, Tasmania Island	Finland Hayfrd	Finland Hayford- Finland
Astrln Geod '84	Australian Geod '84- Australia, Tasmania Island	Gandajika Base	Gandajika Base- Republic of Maldives
Bellevue (IGN)	Efate and Erromango Islands	Geod Datm '49	Geodetic Datum '49- New Zealand
Bermuda 1957	Bermuda 1957- Bermuda Islands	Guam 1963	Guam 1963- Guam Island
Bogata Obsrv	Bogata Obsrvatry- Colombia	Gux 1 Astro	Gux 1 Astro- Guadalcanal Island
Campo Inchspe	Campo Inchauspe- Argentina	Hjorsey 1955	Hjorsey 1955- Iceland
Canton Ast '66	Canton Astro 1966- Phoenix Islands		
Cape	Cape- South Africa		

Hong Kong '63	Hong Kong '63- Hong Kong	NAD27 Canal Zone	North Am. 1927- Canal Zone
Hu-Tzu-Shan	Hu-Tzu-Shan- Taiwan	NAD27 Caribbn	North American 1927- Caribbean (Barbados, Caicos Islands, Cuba, Dom. Rep., Grand Cayman, Jamaica, Leeward and Turks Islands)
Indian Bngldsh	Indian- Bangladesh, India, Nepal	NAD27 Central	North American 1927- Central America (Belize, Costa Rica, El Salvador, Guatemala, Honduras, Nicaragua)
Indian Thailand	Indian- Thailand, Vietnam	NAD27 CONUS	North Am. 1927- Mean Value
Indonesia '74	Indonesia 1974- Indonesia	NAD27 Cuba	North American 1927- Cuba
Ireland 1965	Ireland 1965- Ireland	NAD27 Grnland	North American 1927- Greenland (Hayes Peninsula)
ISTS 073 Astro	ISTS 073 ASTRO '69- Diego Garcia	NAD27 Mexico	N. American 1927- Mexico
Johnston Island	Johnston Island Kandawala- Sri Lanka	NAD27 San Sal	North American 1927- San Salvador Island
Kerguelen Islnd	Kerguelen Island	NAD83	North American 1983- Alaska, Canada, Central America, CONUS, Mexico
Kertau 1948	Kertau 1948- West Malaysia, Singapore	Nhrwn Masirah	Nahrwn- Masirah Island (Oman)
L. C. 5 Astro	Cayman Brac Island	Nhrwn Saudi A	Nahrwn- Saudi Arabia
Liberia 1964	Liberia 1964- Liberia	Nhrwn United A	Nahrwn- United Arab Emirates
Luzon Mindanao	Luzon- Mindanao Island	Naparima BWI	Naparima BWI- Trinidad and Tobago
Luzon Philippine	Luzon- Philippines (excluding Mindanao Island)	Obsrvtorio '66	Observatorio 1966- Corvo and Flores Islands (Azores)
Mahe 1971	Mahe 1971- Mahe Island	Old Egyptian	Old Egyptian- Egypt
Marco Astro	Marco Astro- Salvage Island		
Massawa	Massawa- Eritrea (Ethiopia)		
Merchich	Merchich- Morocco		
Midway Ast '61	Midway Astro '61- Midway		
Minna	Minna- Nigeria		
NAD27 Alaska	North American 1927- Alaska		
NAD27 Bahamas	North American 1927- Bahamas (excluding San Salvador Island)		
NAD27 Canada	North American 1927- Canada and Newfoundland		

APPENDIX F

Map Datums

Old Hawaiian	Old Hawaiian- Mean Value
Oman	Oman- Oman
Ord Srvy GB	Old Survey Grt Britn- England, Isle of Man, Scotland, Shetland Isl., Wales
Pico De Las Nv	Canary Islands
Ptcairn Ast '67	Pitcairn Astro '67- Pitcairn Isl.
Prov S Am '56	Prov So Amrcn '56- Bolivia, Chile, Colombia, Ecuador, Guyana, Peru, Venezuela
Prov S Chln '63	Prov So Chilean '63- S. Chile
Puerto Rico	Puerto Rico & Virgin Islands
Qatar National	Qatar National- Qatar
Qornoq	Qornoq- South Greenland
Reunion	Reunion- Mascarene Island
Rome 1940	Rome 1940- Sardinia Island
RT 90	Sweden
Santo (Dos)	Santo (Dos)- Espirito Santo Island
Sao Braz	Sao Braz- Sao Miguel, Santa Maria Islands (Azores)
Sapper Hill '43	Sapper Hill 1943- East Falkland Island
Schwarzeck	Schwarzeck- Namibia

Sth Amrcn '69	South American '69- Argentina, Bolivia, Brazil, Chile, Colombia, Ecuador, Guyana, Paraguay, Peru, Venezuela, Trinidad and Tobago
South Asia	South Asia- Singapore
SE Base	Southeast Base- Porto Santo and Madiera Islands
SW Base	Southwest Base- Faial, Graciosa, Pico, Sao Jorge and Terceira Islands (Azores)
Timbalai 1948	Timbalai 1948- Brunei and E. Malaysia (Sarawak and Sabah)
Tokyo	Tokyo- Japan, Korea, Okinawa
Tristan Ast '68	Tristan Astro 1968- Tristan da Cunha
Viti Levu 1916	Viti Levu 1916- Viti Levu/ Fiji Islands
Wake-Eniwetok	Wake-Eniwetok- Marshall Isl.
WGS 72	World Geodetic System 1972
WGS 84	World Geodetic System 1984
Zanderij	Zanderij-Surinam
User	User defined datum

The 'User' datum is based on a WGS-84-Local datum and is an advanced feature for unlisted or custom datums. Check your local library or on the world wide web for educational materials on datums and coordinate systems.

Altitude—Height above mean sea level (MSL).

Avg Speed—The average of all second-by-second speed readings since last reset.

Bearing (BRG)—The compass direction from your present position to a destination waypoint.

Course—The desired course between the active 'from' and 'to' waypoints.

Distance (Dist)—The 'great circle' distance from present position to a destination waypoint.

Dist to Dest—The 'great circle' distance from present position to a GOTO destination, or the final waypoint in a route.

Dist to Next—The 'great circle' distance from present position to a GOTO destination, or the next waypoint in a route.

ETA—Estimate Time of Arrival. The estimated time you will reach your destination waypoint, based on current speed and track.

ETA at Dest—The estimated time you will reach a GOTO destination, or the final waypoint in a route.

ETA at Next—The estimated time you will reach a GOTO destination, or the next waypoint in a route.

Fuel—The fuel required to travel from present position to the indicated route waypoint.

Leg Dist—The distance between two route waypoints.

Leg Fuel—The fuel required to travel from a route waypoint to the next waypoint (in sequence) in the route.

Leg Time—The time required to travel from a route waypoint to the next waypoint (in sequence) in the route.

Max Speed—The maximum second-by-second speed recorded since last reset.

Odometer—A running tally of distance travelled, based upon the distance between second-by-second position readings. Both the 'Odometer' and 'Trip Odometer' are resettable, however the 'Odometer' is typically used to keep track of total distance covered, where the 'Trip Odometer' is used to keep track of shorter point-to-point distances.

Off Course—The distance you are off a desired course in either direction, left or right. Also referred to as 'cross-track error' or 'course error'.

Ref—Reference Waypoint. Used to create a new waypoint, by specifying a bearing and distance from an existing (reference) waypoint.

Speed—The current velocity at which you are travelling, relative to a ground position. Also referred to as 'ground speed'.

Time To—The estimated time required to reach a GOTO destination, or the next waypoint in a route. Also referred to as 'estimated time enroute'.

Time to Dest—The estimated time required to reach a GOTO destination, or the final waypoint in a route.

Time to Next—The estimated time required to reach a GOTO destination, or the next waypoint in a route.

APPENDIX G

Navigation Terms

To Course—The recommended direction to steer in order to reduce course error or stay on course. Provides the most efficient heading to get back to the desired course and proceed along your route.

Track—The direction of movement relative to a ground position. Also referred to as 'ground track'.

Trip Odometer—A running tally of distance travelled since last reset. Also see 'Odometer'.

Turn—The angle difference between the bearing to your destination and your current track. 'L' indicates you should turn left, 'R' indicates you should turn right. The degrees indicate the angle you are off course.

VMG—Velocity Made Good. The speed you are closing in on a destination along a desired course. Also referred to as the 'vector velocity' to your destination.

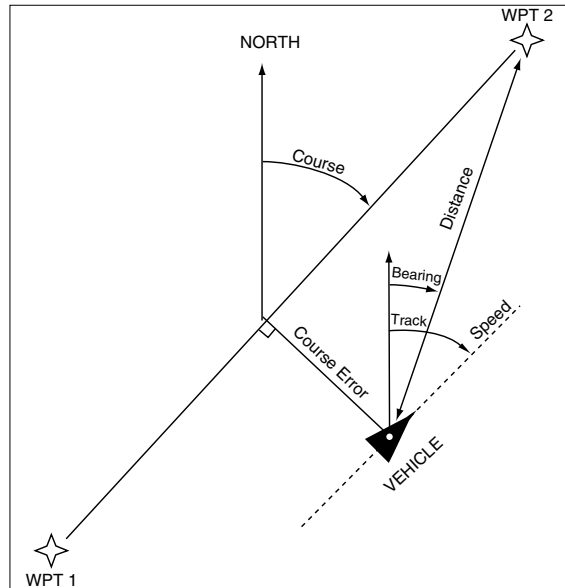

APPENDIX H

Time Offsets

The chart below gives an approximate UTC (Universal Time Coordinate) time offset for the various longitudinal zones. Check with local charts for more detailed information. If you are in daylight savings time, add one hour to the offset.

Longitudinal Zone	Offset	Longitudinal Zone	Offset
W180.0° to W172.5°	-12	E007.5° to E022.5°	+1
W172.5° to W157.5°	-11	E022.5° to E037.5°	+2
W157.5° to W142.5°	-10	E037.5° to E052.5°	+3
W142.5° to W127.5°	-9	E052.5° to E067.5°	+4
W127.5° to W112.5°	-8	E067.5° to E082.5°	+5
W112.5° to W097.5°	-7	E082.5° to E097.5°	+6
W097.5° to W082.5°	-6	E097.5° to E112.5°	+7
W082.5° to W067.5°	-5	E112.5° to E127.5°	+8
W067.5° to W052.5°	-4	E127.5° to E142.5°	+9
W052.5° to W037.5°	-3	E142.5° to E157.5°	+10
W037.5° to W022.5°	-2	E157.5° to E172.5°	+11
W022.5° to W007.5°	-1	E172.5° to E180.0°	+12
W007.5° to E007.5°	0		



A simple way to determine your local time offset is how many hours you are behind or ahead of UTC (also called 'Greenwich' or 'zulu' time).

Example: EST (Eastern Standard Time) is 5 hours behind UTC, so your offset would be -5. Adding one hour for daylight savings would make EDT (Eastern Daylight Time) - 4. Subtract an hour for each time zone as you travel west.

Offsets for Continental U.S. would be:

EST	-5	EDT	-4
CST	-6	CDT	-5
MST	-7	MDT	-6
PST	-8	PDT	-7

APPENDIX I

Index

A

Accuracy Circle	41-42
Active Route Options	41,67-68
Active Route Page	16,66
Alarms	75,81
Almanac	4
Altitude	95
Altitude Entry	29
Antenna, Removing	89
Arrival Alarm	75,81
Arrow, panning	20
AutoLocate™ Mode	6,29
Automatic Shutdown	6
Autotune(DGPS)	84-85
AutoZoom	41-42
Averaging Positions	31,47,52
Average Speed	95

B

Backlight Timer	75,77
Backlighting On/Off	30,77
Battery Installation/Replacement	3
Battery Level Indicator	3,27,77

Battery Type	27,77
Beacon Receiver Setup	84-85
Bearing	95
Bearing Pointer	11,23,43
Big Numbers	11,44

C

Cancel GOTO	16,57
Cautions	ii
Cities, on Map	10,20,33,39-42
Cities, Nearest	15,38-39,53-54
Cities, Spell 'n Find	69-71
Common Exits	35
Compass Page	11,23,45
Compass Page Options	46
Compass Ring	11,23,45
Contrast	25,30
Course	95
Cursor	2

D

Data Entry	2
Date and Time Setup	80
Default	2
Detail, Map	41
DGPS Setup	84-85

Differential GPS (DGPS)	26,84-85
Dilution of Precision (DOP)	28
Display Features	2
Distance	95

E

Enter/Mark Key	2
Estimated Position Error (EPE)	28
Estimated Time of Arrival (ETA)	95
Exit Services	35,38-40,54
Exits	35,38-40,53-54
Exits, Nearest	38-40,53-54

F

Features	1
Field	2
File Tabs	41,53,74
Fuel	95

G

Geo Points	15,38-41,53-54
GOTO Function	15,21,34,55-56
Cancelling	16,57
From List	15
From Map Display	15
Key	2
Nearest Waypoints	55

Options56-57
GPS Overview 4

H

Heading Selection 76
Highlight 2
Highway Display 12,24,43
Highway Page 12,24,43
Highway Page Options 44
Highway Exits 35,52
"How To" Index viii

I

Initialization 4-6,27,29
Installation, antenna 85
Installation, wiring 84
IN Zoom Key 2
Interface Formats 73,81,84
Interface Settings 73,81,84
Interstate Highway Exits 35

K

Keypad Usage 2

L

Lakes, on Map 39-40

Lat/Long Grid39-40
Leg Distance 91
Leg Fuel 91
Leg Time 91
Loran TD82-83

M

Main Menu13,67
Main Page Sequence7,18
Manual Tune(DGPS) 85
Map Datum List88-90
Map Datum Selection73,80
Map Detail 39
Map Orientation10,19,39-40
Map Page10,19,33-34
Map Page Options37-40
Map Scale 10,19,33
Map Setup39-40
MapSource Data 37,39,42,84,91
Mark Position Page 14,22,45
Marking a Position14,22,45-46
Maximum Speed 91
Measuring Between Waypoints 38
Menu Key 2
Messages86-87
MGRS Coordinates 82

MOB Function53,55
Mounting 82

N

Navigation Basics91-92
Navigation Units 76
Nearest Cities 15,38-41,51-52
Nearest Exits 15,38-41,51-52
Nearest Geo Points ... 15,38-41,51-52
Nearest Location Options 52
Nearest Locations List51,64
Nearest To Pointer38-39
Nearest Waypoints ... 15,38-41,51-52
NMEA Output Formats 84

O

Off Course79,91
Offset, local time 78
Odometer 91
Orientation, map10,19
Orientation, screen1,75
OUT Zoom Key 2
Output Setup 81

APPENDIX I

Index

P

Package Contents	i
Page Key	2
Page Sequence	7,18
Panning	20,33-34
Pointer Arrow	11,12,23-24
Position Averaging	31,47,52
Position Format	9,75,82
Position Page	9,30
Position Page Options	31-32
Power Key	2,7
Power Off	6
Power On	5,17
Power Saver Mode	75,77

Q

Quit Key	2,7
----------	-----

R

Railroads, on Map	41-42
Receiver Status	8,26-27
Reference Waypoints	48-49,70-71
Registration	v

Rivers, on Map	41-42
Roads, on Map	41-42
Rocker Keypad	2

Routes

Active Route Page	66-67
Activating	62,65
Copying	65
Creating	60,65
Creating From Map	61
Deactivating	62,68
Deleting	65,68
Deleting All	66
Editing Routes	63-64,68
Inverting	64
List	62
Naming	62
Options	65-68
Planning	64,67
Route Plan Page	63-64

S

Satellite Status Page	8,25
Satellite Status Page Options	28-29
Screen Backlighting	28
Screen Contrast	25,30

Screen Orientation	1,77
Scrolling	2
Serial Number	v
Services, at Exit	35,53-54
Setup Options	13,74-85
Sign Posts	46
Signal Strength Bars	8,25
Simulator Mode	17-18,28,75-76
Simulator Tour	17-24
Sky View Display	8,25,28
SNR(DGPS)	85
Special Exits	35
Specifications	87
Speed	95
Spell 'n Find	50,69-70
Street/Road Labels	41-42
Submenus	13
System Setup	75,77

T

Text Output	84
Time Format	80
Time Settings	75,80
Timers	75,79
Topo Information	15,37,41,53-54
TracBack Navigation	55,58-59,71-72

APPENDIX I

Index

Track	96
Track Compass	9,12
Track Logs	58-59, 71-74
Clearing Active	58,72
Deleting	72
Deleting All	73
Displaying	74
Naming	72
Options	72-73
Recording	58,71-73
Saving Active	72
Track Log Setup	41,58,71-73
Trip Computer	9,74
Trip Odometer	9,74,96
Trip Planning	64,67
Troubleshooting	6
Turn	96
2D Altitude	29
U	
Unit Features	1
Units of Measure	13,75,78
User Datum	94
User Grid	82
UTC time	80
UTM Coordinates	82

V	
Velocity Made Good (VMG)	96
W	
Warnings	ii
Warranty	iv
Waypoints	14,47-52,69
Comments	51
Create By Text	48
Create On Map	20,48
Deleting	50,52
Deleting All	50
Deleting by Symbol	50
Display Options	52
Edit Options	52
Editing	50-51
List Options	49-50
Marking	14,47
Naming	14,20,47-48
Nearest	52,55,71
Options	52
Waypoints	
Reference	49,70,95
Renaming	14,22,51
Reviewing	34,50
Sign Posts	46

Symbols	14,19,22,50-51
Waypoint Edit Page	50
Waypoint List Options	49
Waypoint List Page	48,69
Web Site	covers,v,88
Welcome Page	5,17
Wiring Installation	88

Z

Zoom In/Out	10,19,33,36,39,41-42,45
Zoom Keys	2,19,39,45,70



© 1999-2001 GARMIN Corporation

GARMIN International, Inc., 1200 E. 151st Street, Olathe, KS 66062

GARMIN (Europe) Ltd., Unit 5, The Quadrangle, Abbey Park Industrial Estate, Romsey SO51 9AQ UK

GARMIN Corporation, No. 68, Jangshu 2nd Road, Shijr, Taipei County, Taiwan

Web Site Address: www.garmin.com

Part Number 190-00162-00 Rev. B