

GARMIN

CIRRUS PERSPECTIVE®

BY GARMIN.



Cirrus SR22x
Integrated Avionics System Pilot's Guide
System Software Version 0764.36 or later

SYSTEM OVERVIEW

FLIGHT INSTRUMENTS

ENGINE INDICATION SYSTEM

AUDIO PANEL & CNS

FLIGHT MANAGEMENT

HAZARD AVOIDANCE

AUTOMATIC FLIGHT CONTROL SYSTEM

ADDITIONAL FEATURES

APPENDICES

INDEX

BLANK PAGE

Copyright © 2008-2015, 2018, 2019 Garmin Ltd. or its subsidiaries. All rights reserved.

This manual reflects the operation of System Software 0764.36 or later for the Cirrus Perspective by Garmin Integrated Avionics System. Where used, references to 'SR2x' are inclusive of the SR20, SR22 (3400 lb & 3600 lb GW), SR22TN (3400 lb GW only), and SR22T (3400 lb & 3600 lb GW). Some differences in operation may be observed when comparing the information in this manual to earlier or later software versions. Always refer to the FAA approved pertinent flight manual for a description of systems, limitations, and procedures.

Garmin International, Inc.
1200 East 151st Street
Olathe, Kansas 66062, U.S.A.

Garmin (Europe) Ltd.
Liberty House, Hounsdown Business Park
Southampton, Hampshire SO40 9LR U.K.

Garmin AT, Inc.
2345 Turner Road SE
Salem, OR 97302, U.S.A.

Garmin Corporation
No. 68, Zhangshu 2nd Road
Xizhi District, New Taipei City, Taiwan

Contact Garmin Product Support at www.flygarmin.com.

For warranty information refer to www.flygarmin.com.

Except as expressly provided herein, no part of this manual may be reproduced, copied, transmitted, disseminated, downloaded or stored in any storage medium, for any purpose without the express written permission of Garmin. Garmin hereby grants permission to download a single copy of this manual and of any revision to this manual onto a hard drive or other electronic storage medium to be viewed for personal use, provided that such electronic or printed copy of this manual or revision must contain the complete text of this copyright notice and provided further that any unauthorized commercial distribution of this manual or any revision hereto is strictly prohibited.

Garmin®, G1000®, GDL®, FliteCharts®, ConnexT®, and SafeTaxi® are registered trademarks of Garmin International, Inc. or its subsidiaries. Garmin ESP™, Garmin SVT™, and SurfaceWatch™ are trademarks of Garmin International, Inc. or its subsidiaries. These trademarks may not be used without the express permission of Garmin.

Perspective™ is a trademark of Cirrus Design Corporation.

Skywatch® and Stormscope® are registered trademarks of L-3 Communications. Ryan®, TCAD® and Avidyne® are registered trademarks of Avidyne Corporation. CO Guardian is a trademark of CO Guardian, Inc. AC-U-KWIK® is a registered trademark of Penton Business Media Inc. Bendix/King® and Honeywell® are registered trademarks of Honeywell International, Inc. Becker® is a registered trademark of Becker Flugfunkwerk GmbH. NavData® is a registered trademark of Jeppesen, Inc.; Wi-Fi® is a registered trademark of the Wi-Fi Alliance. Sirius, XM, and all related marks and logos are trademarks of Sirius XM Radio, Inc. and its subsidiaries. The Bluetooth® word mark and logos are owned by the Bluetooth SIG, Inc. and any use of such marks by Garmin is under license.

AOPA Membership Publications, Inc. and its related organizations (hereinafter collectively "AOPA") expressly disclaim all warranties, with respect to the AOPA information included in this data, express or implied, including, but not limited to, the implied warranties of merchantability and fitness for a particular purpose. The information is provided "as is" and AOPA does not warrant or make any representations regarding its accuracy, reliability, or otherwise. Under no circumstances including negligence, shall AOPA be liable for any incidental, special or consequential damages that result from the use or inability to use the software or related documentation, even if AOPA or an AOPA authorized representative has been advised of the possibility of such damages. User agrees not to sue AOPA and, to the maximum extent allowed by law, to release and hold harmless AOPA from any causes of action, claims or losses related to any actual or alleged inaccuracies in the information. Some jurisdictions do not allow the limitation or exclusion of implied warranties or liability for incidental or consequential damages so the above limitations or exclusions may not apply to you.

AC-U-KWIK and its related organizations (hereafter collectively "AC-U-KWIK Organizations") expressly disclaim all warranties with respect to the AC-U-KWIK information included in this data, express or implied, including, but not limited to, the implied warranties of merchantability and fitness for a particular purpose. The information is provided "as is" and AC-U-KWIK Organizations do not warrant or make any representations regarding its accuracy, reliability, or otherwise. Licensee agrees not to sue AC-U-KWIK Organizations and, to the maximum extent allowed by law, to release and hold harmless AC-U-KWIK Organizations from any cause of action, claims or losses related to any actual or alleged inaccuracies in the information arising out of Garmin's use of the information in the datasets. Some jurisdictions do not allow the limitation or exclusion of implied warranties or liability for incidental or consequential damages so the above limitations or exclusions may not apply to licensee.

-
-  **WARNING:** Do not use terrain avoidance displays as the sole source of information for maintaining separation from terrain and obstacles. Garmin obtains terrain and obstacle data from third party sources and cannot independently verify the accuracy of the information.
-
-  **WARNING:** Always refer to current aeronautical charts and NOTAMs for verification of displayed aeronautical information. Displayed aeronautical data may not incorporate the latest NOTAM information.
-
-  **WARNING:** Do not use geometric altitude for compliance with air traffic control altitude requirements. The primary barometric altimeter must be used for compliance with all air traffic control altitude regulations, requirements, instructions, and clearances.
-
-  **WARNING:** Do not use basemap information (land and water data) as the sole means of navigation. Basemap data is intended only to supplement other approved navigation data sources and should be considered only an aid to enhance situational awareness.
-
-  **WARNING:** Do not rely solely upon the display of traffic information to accurately depict all of the traffic within range of the aircraft. Due to lack of equipment, poor signal reception, and/or inaccurate information from aircraft or ground stations, traffic may be present that is not represented on the display.
-
-  **WARNING:** Do not use data link weather information for maneuvering in, near, or around areas of hazardous weather. Information contained within data link weather products may not accurately depict current weather conditions.
-
-  **WARNING:** Do not use the indicated data link weather product age to determine the age of the weather information shown by the data link weather product. Due to time delays inherent in gathering and processing weather data for data link transmission, the weather information shown by the data link weather product may be older than the indicated weather product age.
-
-  **WARNING:** Do not rely on the displayed minimum safe altitude (MSAs) as the sole source of obstacle and terrain avoidance information. Always refer to current aeronautical charts for appropriate minimum clearance altitudes.
-
-  **WARNING:** Do not operate this equipment without first obtaining qualified instruction.
-
-  **WARNING:** Do not use GPS to navigate to any active waypoint identified as a 'NON WGS84 WPT' by a system message. 'NON WGS84 WPT' waypoints are derived from an unknown map reference datum that may be incompatible with the map reference datum used by GPS (known as WGS84) and may be positioned in error as displayed.
-
-  **WARNING:** Do not rely on the autopilot to level the aircraft at the MDA/DH when flying an approach with vertical guidance. The autopilot will not level the aircraft at the MDA/DH even if the MDA/DH is set in the altitude preselect.
-

 **WARNING:** Do not rely solely upon the display of traffic information for collision avoidance maneuvering. The traffic display does not provide collision avoidance resolution advisories and does not under any circumstances or conditions relieve the pilot's responsibility to see and avoid other aircraft.

 **WARNING:** Do not rely on the accuracy of attitude and heading indications in the following geographic areas (due to variations in the earth's magnetic field): North of 72° North latitude at all longitudes; South of 70° South latitude at all longitudes; North of 65° North latitude between longitude 75° W and 120° W. (Northern Canada); North of 70° North latitude between longitude 70° W and 128° W. (Northern Canada); North of 70° North latitude between longitude 85° E and 114° E. (Northern Russia); South of 55° South latitude between longitude 120° E and 165° E. (Region south of Australia and New Zealand).

 **WARNING:** Do not rely on information from a lightning detection system display as the sole basis for hazardous weather avoidance. Range limitations and interference may cause the system to display inaccurate or incomplete information. Refer to documentation from the lightning detection system manufacturer for detailed information about the system.

 **WARNING:** Use appropriate primary systems for navigation, and for terrain, obstacle, and traffic avoidance. Garmin SVT is intended as an aid to situational awareness only and may not provide either the accuracy or reliability upon which to solely base decisions and/or plan maneuvers to avoid terrain, obstacles, or traffic.

 **WARNING:** Do not use TAWS information for primary terrain or obstacle avoidance. TAWS is intended only to enhance situational awareness.







 **WARNING:** Do not use a QFE altimeter setting with this system. System functions will not operate properly with a QFE altimeter setting. Use only a QNH altimeter setting for height above mean sea level, or the standard pressure setting, as applicable.

 **CAUTION:** Do not clean display surfaces with abrasive cloths or cleaners containing ammonia. They will harm the anti-reflective coating.

 **CAUTION:** Do not allow repairs to be made by anyone other than an authorized Garmin service center. Unauthorized repairs or modifications could void both the warranty and affect the airworthiness of the aircraft.

 **NOTE:** Do not rely solely upon data link services to provide Temporary Flight Restriction (TFR) information. Always confirm TFR information through official sources such as Flight Service Stations or Air Traffic Control.

 **NOTE** All visual depictions contained within this document, including screen images of the system panel and displays, are subject to change and may not reflect the most current system and aviation databases. Depictions of equipment may differ slightly from the actual equipment.

-
-  **NOTE:** The United States government operates the Global Positioning System and is solely responsible for its accuracy and maintenance. The GPS system is subject to changes which could affect the accuracy and performance of all GPS equipment. Portions of the system utilize GPS as a precision electronic NAVigation AID (NAVAID). Therefore, as with all NAVAIDs, information presented by the system can be misused or misinterpreted and, therefore, become unsafe.
-
-  **NOTE:** This device complies with part 15 of the FCC Rules. Operation is subject to the following two conditions: (1) this device may not cause harmful interference, and (2) this device must accept any interference received, including interference that may cause undesired operation.
-
-  **NOTE:** Interference from GPS repeaters operating inside nearby hangars can cause an intermittent loss of attitude and heading displays while the aircraft is on the ground. Moving the aircraft more than 100 yards away from the source of the interference should alleviate the condition.
-
-  **NOTE:** Use of polarized eyewear may cause the flight displays to appear dim or blank.
-
-  **NOTE:** This product, its packaging, and its components contain chemicals known to the State of California to cause cancer, birth defects, or reproductive harm. This notice is being provided in accordance with California's Proposition 65. If you have any questions or would like additional information, please refer to our web site at www.garmin.com/prop65.
-
-  **NOTE:** Operating the system in the vicinity of metal buildings, metal structures, or electromagnetic fields can cause sensor differences that may result in nuisance miscompare annunciations during start up, shut down, or while taxiing. If one or more of the sensed values are unavailable, the annunciation indicates no comparison is possible.
-
-  **NOTE:** The system responds to a terminal procedure based on data coded within that procedure in the Navigation Database. Differences in system operation may be observed among similar types of procedures due to differences in the Navigation Database coding specific to each procedure.
-

 **NOTE:** The FAA has asked Garmin to remind pilots who fly with Garmin database-dependent avionics of the following:

- It is the pilot's responsibility to remain familiar with all FAA regulatory and advisory guidance and information related to the use of databases in the National Airspace System.
- Garmin equipment will only recognize and use databases that are obtained from Garmin or Jeppesen. Databases obtained from Garmin or Jeppesen that have a Type 2 Letter of Authorization (LOA) from the FAA are assured compliance with all data quality requirements (DQRs). A copy of the Type 2 LOA is available for each applicable database and can be viewed at <http://fly.garmin.com> by selecting 'Aviation Database Declarations.'
- Use of a current Garmin or Jeppesen database in your Garmin equipment is required for compliance with established FAA regulatory guidance, but does not constitute authorization to fly any and all terminal procedures that may be presented by the system. It is the pilot's responsibility to operate in accordance with established AFM(S) and regulatory guidance or limitations as applicable to the pilot, the aircraft, and installed equipment.

 **NOTE:** The pilot/operator must review and be familiar with Garmin's database exclusion list as discussed in SAIB CE-14-04 to determine what data may be incomplete. The database exclusion list can be viewed at www.flygarmin.com by selecting 'Database Exclusions List.'







 **NOTE:** The pilot/operator must have access to Garmin and Jeppesen database alerts and consider their impact on the intended aircraft operation. The database alerts can be viewed at www.flygarmin.com by selecting 'Aviation Database Alerts.'

 **NOTE:** If the pilot/operator wants or needs to adjust the database, contact Garmin Product Support.

 **NOTE:** Garmin requests the flight crew report any observed discrepancies related to database information. These discrepancies could come in the form of an incorrect procedure; incorrectly identified terrain, obstacles and fixes; or any other displayed item used for navigation or communication in the air or on the ground. Go to FlyGarmin.com and select 'Aviation Data Error Report'.

 **NOTE:** Electronic aeronautical charts displayed on this system have been shown to meet the guidance in AC 120-76D as a Type B Electronic Flight Bag (EFB) for FliteCharts and ChartView. The accuracy of the charts is subject to the chart data provider. Own-ship position on airport surface charts cannot be guaranteed to meet the accuracy specified in AC 120-76D. Possible additional requirements may make a secondary source of aeronautical charts, such as traditional paper charts or an additional electronic display, necessary on the aircraft and available to the pilot. If the secondary source of aeronautical charts is a Portable Electronic Device (PED), its use must be consistent with the guidance in AC 120-76D.

 **NOTE:** The navigation databases used in Garmin navigation systems contain Special Procedures. Prior to flying these procedures, pilots must have specific FAA authorization, training, and possession of the corresponding current, and legitimately-sourced chart (approach plate, etc.). Inclusion of the Special Procedure in the navigation database DOES NOT imply specific FAA authorization to fly the procedure.

-
-  **NOTE:** Terrain and obstacle alerting is not available north of 89° North latitude and south of 89° South latitude. This is due to limitations present within the Terrain database and the system's ability to process the data representing the affected areas.
-
-  **NOTE:** Lamp(s) inside this product contain mercury (HG) and must be recycled or disposed of according to local, state, or federal laws. For more information, refer to our website at www.garmin.com/en-US/company/environment/recycling
-
-  **NOTE:** When using Stormscope, there are several atmospheric phenomena in addition to nearby thunderstorms that can cause isolated discharge points in the strike display mode. However, clusters of two or more discharge points in the strike display mode do indicate thunderstorm activity if these points reappear after the screen has been cleared.
-
-  **NOTE:** Intruder aircraft at or below 500 ft. AGL may not appear on the Garmin SVT display or may appear as a partial symbol.
-
-  **NOTE:** The nose of the 'own ship' symbol represents the location of the aircraft. The center of any traffic symbol represents the location of that traffic. The traffic and own ship symbols are an abstract representation and do not reflect the physical extent of the aircraft/traffic, and should not replace other methods for identifying traffic.
-
-  **NOTE:** Operate Perspective™ system power through at least one cycle in a period of four days of continuous operation to avoid an autonomous system reboot.
-

BLANK PAGE

SOFTWARE LICENSE AGREEMENT

BY USING THE DEVICE, COMPONENT OR SYSTEM MANUFACTURED OR SOLD BY GARMIN ("THE GARMIN PRODUCT"), YOU AGREE TO BE BOUND BY THE TERMS AND CONDITIONS OF THE FOLLOWING SOFTWARE LICENSE AGREEMENT. PLEASE READ THIS AGREEMENT CAREFULLY. Garmin Ltd. and its subsidiaries ("Garmin") grants you a limited license to use the software embedded in the Garmin Product (the "Software") in binary executable form in the normal operation of the Garmin Product. Title, ownership rights, and intellectual property rights in and to the Software remain with Garmin and/or its third-party providers. You acknowledge that the Software is the property of Garmin and/or its third-party providers and is protected under the United States of America copyright laws and international copyright treaties. You further acknowledge that the structure, organization, and code of the Software are valuable trade secrets of Garmin and/or its third-party providers and that the Software in source code form remains a valuable trade secret of Garmin and/or its third-party providers. You agree not to reproduce, decompile, disassemble, modify, reverse assemble, reverse engineer, or reduce to human readable form the Software or any part thereof or create any derivative works based on the Software. You agree not to export or re-export the Software to any country in violation of the export control laws of the United States of America.

BLANK PAGE

Record of Revisions				
Part Number	Revision	Date	Page Range	Description
190-00820-00	A	04/11/08	ALL	Initial release
	B	05/02/08	408 through 421	Made clerical changes
	C	05/12/08	v	Made clerical changes
	D	06/04/08	184 and I-1	Made update to optional equipment and made clerical changes
190-00820-01	A	09/29/08	i – I-6	Added Enhanced Vision System Added changes in page navigation Added new procedures for creating user waypoints Added importing and exporting flight plans Updated Warning, Caution and Advisory Alerts Added other GDU 9.12 parameters
190-00820-02	A	11/17/08	i – I-6	Added Flight Into Known Icing (FIKI) Added the SR20 Added other GDU 9.12 parameters
190-00820-03	A	6/30/09	i – I-6	Added AOPA Airport Directory Added dual navigation database capability Added database synchronization Added other GDU 10.00 parameters
190-00820-04	A	2/28/10	i – I-6	Added the SR22T Updated Warning and Caution Alerts Added other GDU 11.00 parameters
190-00820-05	A	5/3/10	i – I-6	Added GTX 33 w/ES transponder option Added GTS 800 traffic option Added other GDU 11.01 parameters
190-00820-06	A	11/15/10	i-I-6	Added Profile View Updated Active Flight Plan modification procedures to include the Quick Select Box and Insertion Point Indicator Updated XM Weather product status display Added Electronic Stability and Protection Added Underspeed Protection Added Selected Altitude Intercept Arc Added Hypoxia Recognition System Added other GDU 11.11 parameters
190-00820-07	A	10/7/11	i-I-6	Added GMA 350 Audio Panel Added Iridium Satellite Telephone Added GFDS Worldwide Weather Added WX LGND, LEGEND, and METAR Softkeys Added other GDU 12.01 parameters

Record of Revisions				
Part Number	Revision	Date	Page Range	Description
190-00820-08	A	12/16/2011	i-I-6	Added Pilot Profile Import/Export Added XM mute capability to XM Info and XM Radio pages Replace BRG field with ETE field on PFD Added other GDU 12.10 parameters
190-00820-09	A	01/14/2013	i-I-6	Added GDL 59 Added integrated fuel gauges Added fuel imbalance aircraft alerts Added AC-U-KWIK airport directory Added other GDU 12.11 parameters
190-00820-09	B	01/29/2013	i-I-6	Updated Advisory Alerts table Made clerical changes
190-00820-10	A	01/24/2014	i-I-6	Added independent display of Flight Path Marker Added Ground Speed display to PFD Added user-defined holding patterns Added support for LP approaches Added stall CAS message Added spin recognition CAS message Added Connex position reporting feature Removed CO RST Softkey Added other GDU 14.01 parameters
190-00820-11	A	12/18/2015	i-I-6	Added GMA 350c Added GDL 88 Added Flight Stream 210 Added Baro VNAV Added support for SR18 Updated HSI icon Added other GDU 15.01 parameters
190-00820-12	A	11/16/2018	All	Production release at GDU 15.24 Made clerical changes throughout Removed support for SR18 Updated CAS messages Updated aural alerts Added approval as Type B EFB Fixed AOA sensor auto conditions Added stick shaker Added VRPs
190-00820-12	B	01/10/2019	All	Removed Stick Shaker Updated Voice Alert

SECTION 1 SYSTEM OVERVIEW	
1.1	Garmin Line Replaceable Units (LRU) 2
1.2	System Controls 8
	PFD/MFD Controls 8
	PFD/MFD Control Unit..... 10
	GMA 350/350c Audio Panel Controls..... 13
	GMA 347 Audio Panel Controls..... 16
	Softkey Function..... 18
1.3	System Power-up 27
1.4	System Operation 28
	Display Operation 28
	System Annunciations 30
	System Status..... 31
	AHRS Operation 32
	GPS Receiver Operation 33
1.5	Accessing System Functionality 38
	Menus 38
	Page Groups 39
	System Settings 43
	Timers 52
	GPS Position 54
1.6	Display Backlighting 55
1.7	Secure Digital Cards 56
SECTION 2 FLIGHT INSTRUMENTS	
2.1	Flight Instruments 60
	Airspeed Indicator 60
	Attitude Indicator 62
	Altimeter 63
	Vertical Speed Indicator (VSI)..... 65
	Vertical Deviation 65
	Horizontal Situation Indicator (HSI) 66
	Course Deviation Indicator (CDI) 71
2.2	Supplemental Flight Data 78
	Temperature Display 78
	Wind Data 80
	Angle of Attack (AOA) Indicator 81
	Vertical Navigation (VNV) Indications..... 82
2.3	PFD Annunciations and Alerting Functions 83
	Marker Beacon Annunciations..... 83
	Baro Transition Alert..... 83
	Traffic Annunciation 84
	Terrain Annunciations 85
	Altitude Alerting 85
	Low Altitude Annunciation 86
	Minimum Altitude Alerting 86
2.4	Abnormal Operations 88
	Abnormal GPS Conditions 88
	Heading Failure Modes..... 89
	Unusual Attitudes 90
SECTION 3 ENGINE INDICATION SYSTEM	
3.1	EIS Display 92
3.2	Engine Page 95
	Fuel Calculations 99
	Ice Protection Systems 101
3.3	Leaning Assist Mode 104
3.4	EIS Display in Reversionary Mode 105
	System Display 106
SECTION 4 AUDIO PANEL AND CNS	
4.1	Overview 109
	MFD/PFD Controls and Frequency Display 110
	GMA 350/350c Audio Panel Controls..... 112
	GMA 347 Audio Panel Controls..... 114
	Control Unit 116
4.2	COM Operation 118
	COM Transceiver Selection and Activation 118
	COM Transceiver Manual Tuning 119
	Quick-tuning and Activating 121.500 MHz..... 120
	Auto-tuning the COM Frequency 121
	Frequency Spacing..... 125
	Automatic Squelch..... 126
	Volume..... 126
4.3	NAV Operation 127
	NAV Radio Selection and Activation 127
	NAV Receiver Manual Tuning..... 128
	Auto-tuning a NAV Frequency from the MFD..... 130
	Auto-tuning NAV Frequencies on Approach Activation . 133
	Marker Beacon Receiver 133
	DME Tuning 135
4.4	GTX 32/GTX 33 Transponder 136
	Transponder Controls..... 136
	Transponder Mode Selection..... 137
	Entering a Transponder Code 140
	IDENT Function 142

- 4.5 Additional Audio Panel Functions** 143
 - Power-Up 143
 - Mono/Stereo Headsets 143
 - Speaker 143
 - Passenger Address Mode (PA Mode) 143
 - Clearance Recorder and Player 143
 - Intercom System (ICS) with the GMA 350/350c 144
 - Split COM Mode with the GMA 350/350c 149
 - 3D Audio (GMA 350/350c Only) 149
 - Intercom with the GMA 347 151
 - Split COM with the GMA 347 154
 - Entertainment Inputs with the GMA 350 154
 - Entertainment Inputs with the GMA 347 155
 - Bluetooth® (GMA 350c Only) 156
- 4.6 Audio Panel Preflight Procedure** 158
 - GMA 350/350c Preflight 158
 - GMA 347 Preflight 158
- 4.7 Abnormal Operation** 160
 - Audio Panel Fail-safe Operation 160
 - Stuck Microphone 160
 - COM Tuning Failure 160

SECTION 5 FLIGHT MANAGEMENT

- 5.1 Introduction** 161
 - Navigation Status Box 162
- 5.2 Using Map Displays** 164
 - Map Orientation 164
 - Map Range 166
 - Map Panning 169
 - Measuring Bearing and Distance 173
 - Topography 174
 - Map Symbols 177
 - Airways 182
 - Track Vector 185
 - Wind Vector 186
 - Nav Range Ring 187
 - Fuel Range Ring 188
 - Field of View (SVT) 189
 - Selected Altitude Intercept Arc 190
 - Destination Airport Information 191
- 5.3 Waypoints** 192
 - Airports 193
 - Intersections 200

- NDBs 202
- VORs 204
- VRPs 206
- User Waypoints 208
- 5.4 Airspaces** 214
- 5.5 Direct-to-Navigation** 218
- 5.6 Flight Planning** 223
 - Flight Plan Creation 224
 - Adding Waypoints to an Existing Flight Plan 231
 - Adding Airways to a Flight Plan 234
 - Adding Procedures to a Stored Flight Plan 236
 - Flight Plan Storage 243
 - Flight Plan Editing 245
 - Along Track Offsets 249
 - Parallel Track 250
 - Activating a Flight Plan Leg 253
 - Inverting a Flight Plan 254
 - Flight Plan Views 255
 - Closest Point of FPL 257
 - User-Defined Holding Patterns 258
- 5.7 Vertical Navigation** 264
 - Altitude Constraints 266
- 5.8 Procedures** 271
 - Departures 272
 - Arrivals 275
 - Approaches 277
- 5.9 Trip Planning** 286
 - Trip Planning 286
- 5.10 RAIM Prediction** 290
- 5.11 Navigating a Flight Plan** 293
- 5.12 Abnormal Operation** 317

SECTION 6 HAZARD AVOIDANCE

- 6.1 SiriusXM Weather** 320
 - Activating Services 320
 - Using SiriusXM Weather Products 321
- 6.2 Garmin Connex Weather** 356
 - Accessing Garmin Connex Weather Products 356
 - Registering the Iridium Satellite System 356
 - Registering the system for Garmin Connex Weather 358
 - Connex Weather Data Requests 367
 - Garmin Connex Weather Products 371
 - Abnormal Operations 387

6.3 FIS-B Weather	389	6.12 Garmin GDL 88 ADS-B Traffic	477
Using FIS-B Weather Products	389	ADS-B System Overview	477
FIS-B Weather Status	411	ADS-B with TAS	479
6.4 Lightning Detection System	412	Conflict Situational Awareness & Alerting	480
Setting Up Lightning Detection on the Navigation Map	412	Airborne and Surface Applications	483
Selecting the Stormscope Page	416	Traffic Description	484
6.5 Terrain Proximity	417	Operation	484
Displaying Terrain Proximity Data	417	System Status	493
Terrain Proximity Page	420		
6.6 Terrain-SVS	422	SECTION 7 AUTOMATIC FLIGHT CONTROL SYSTEM	
Displaying Terrain-SVS Data	423	7.1 Garmin AFCS	497
Terrain-SVS Page	425	AFCS Controls	498
Terrain-SVS Alerts	427	Flight Director Operation	500
System Status	430	Vertical Modes	503
6.7 TAWS-B	431	Lateral Modes	517
Displaying TAWS-B Data	432	Autopilot and Yaw Damper Operation	524
TAWS-B Page	434	Example Flight Plan	526
TAWS-B Alerts	436	AFCS Annunciations and Alerts	540
System Status	442	Overspeed Protection	541
6.8 Profile View Terrain	444	Underspeed Protection	541
Profile View Display	445	7.2 S-TEC Fifty Five X Autopilot (Optional)	544
6.9 Garmin GTS 800 Traffic	448		
Theory of operation	448	SECTION 8 ADDITIONAL FEATURES	
TAS Alerts	452	8.1 Synthetic Vision Technology (SVT)	546
System Test	453	SVT Operation	547
Operation	454	SVT Features	549
System Status	461	Field of View	558
6.10 Avidyne TAS610 Traffic	462	8.2 Enhanced Vision System & Auxiliary Video	560
TAS Symbology	462	EVS Image Quality and Interpretation	560
Displaying Traffic Information	463	Video Softkeys	560
Altitude Display	465	Zoom/Range	563
Traffic Map Page Display Range	465	8.3 SafeTaxi	564
TAS Alerts	467	8.4 ChartView	567
System Status	468	ChartView Softkeys	568
6.11 L-3 Skywatch Traffic	469	Terminal Procedures Charts	569
TAS Symbology	469	Chart Options	578
Operation	470	Day/Night View	583
Displaying Traffic Information	470	8.5 FliteCharts	586
Altitude Display	473	FliteCharts Softkeys	587
Traffic Map Page Display Range	473	Terminal Procedures Charts	587
TAS Alerts	475	Chart Options	595
System Status	475	Day/Night View	598
		8.6 Airport Directory	600

8.7 Database Cycle Number and Revisions	601	Terrain-SVS System Status Annunciations	682
Cycle Number and Revision	601	TAWS-B ALERTS	682
8.8 SiriusXM Satellite Radio Entertainment	603	TAWS-B System Status Annunciations	684
Activating SiriusXM Satellite Radio Services	603	Flight Plan Import/Export Messages	684
Using SiriusXM Radio	604	Pilot Profile Import/Export Messages	685
8.9 Satellite Telephone & SMS Messaging Service	608	TAS System Annunciations	685
Registering the Iridium Satellite System	608	ADS-B Traffic Annunciations	686
Telephone Communication	609	Connex Weather Messages	688
Text Messaging (SMS)	620	Database Management	689
8.10 WI-FI Connections	631	Jeppesen Databases	689
8.11 Scheduler	636	Garmin Databases	693
8.12 Electronic Checklists	638	Aviation Terms and Acronyms	701
8.13 Flight Data Logging	641	Frequently Asked Questions	711
8.14 Hypoxia Recognition with Automatic Descent Mode	643	Map Symbols	715
Determining Pilot Alertness	643		
Automatic Descent Mode	644		
8.15 Electronic Stability and Protection (ESP™)	646		
Roll Engagement	646		
Pitch Engagement	648		
Low Speed Protection	649		
High Airspeed Protection	650		
8.16 Position Reporting	651		
8.17 Bluetooth® Management	654		
8.18 Abnormal Operation	656		
SVT Troubleshooting	656		
Reversionary Mode	656		
Unusual Attitudes	657		

INDEX

Index	I-1
--------------------	-----

APPENDICES

Annunciations and Alerts	659
Alert Level Definitions	661
Aircraft Alerts	662
Perspective Voice Alerts	666
GTS 800 Traffic Advisory System Voice Alerts	666
System Annunciations	667
System Message Advisories	669
ADS-B Status Page Messages	679
AFCS Status Alerts	680
Garmin AFCS Condition/Stall Alert	681
Terrain-SVS Alerts	681

SECTION 1 SYSTEM OVERVIEW

The Cirrus Perspective® Integrated Avionics by Garmin presents flight instrumentation, position, navigation, communication, and identification information to the pilot through large-format displays. The system consists of the following Garmin Line Replaceable Units (LRUs), listed alphabetically:

- **FlightStream 210** Bluetooth® Wireless Gateway (optional)
- **GCU 478** PFD/MFD Control Unit
- **GDC 74A** Air Data Computer (ADC)
- **GDL 59** Data Link (optional)
- **GDL 69/69A/69A SXM** Satellite Data Link Receiver (optional)
- **GDU 1240A** Primary Flight Display (PFD)
- **GDU 1240A** Multi Function Display (MFD)
- **GDU 1040A** Primary Flight Display (optional)
- **GDU 1040A** Multi Function Display (optional)
- **GEA 71** Engine/Airframe Unit
- **GIA 63W** Integrated Avionics Unit
- **GMA 347/350** Audio Panel with Integrated Marker Beacon Receiver
- **GMC 705** AFCS Control Unit (if the Garmin Automatic Flight Control System (AFCS) is installed)
- **GMU 44** Magnetometer
- **GRC 10** Remote Control (option with GDL 69A)
- **GRS 77** Attitude and Heading Reference System (AHRS)
- **GRT 10** SiriusXM Radio Remote Transceiver (option with GDL 69A/69A SXM)
- **GSA 80** AFCS Yaw Servo (if the Garmin AFCS is installed)
- **GSA 81** AFCS Pitch and Roll Servos (if the Garmin AFCS is installed)
- **GSR 56** Iridium Transceiver (optional)
- **GTP 59** Outside Air Temperature (OAT) Probe
- **GTX 32** Transponder (optional)
- **GTX 33** Mode S Transponder (optional)
- **GTX 33 ES** Mode S Transponder with 1090 MHz Extended Squitter (1090ES) (optional)
- **GSM 85/86** Servo Gearboxes (if the Garmin AFCS is installed)
- **GTA 82** Pitch Trim Adapter (if the Garmin AFCS is installed)

A top-level system block diagram is shown in Figure 1-1 (it does not include the GSM 85, GTA 82, GRC 10, or GRT 10).

The optional Garmin Automatic Flight Control System (AFCS) provides the flight director (FD), autopilot (AP), yaw damper (YD - optional), and manual electric trim (MET) functions. Refer to the AFCS section for more information.

1.1 GARMIN LINE REPLACEABLE UNITS (LRU)

- **GDU 1240A-30/1040A-30** (1) – This unit is configured as a PFD that features a 12 or 10.4-inch LCD with 1024 x 768 resolution. The unit installed on the left/pilot side is designated as the PFD. This unit communicates with the GDU 1240A-20/1040A-20 (MFD), and with the on-side GIA 63W Integrated Avionics Unit through a High-Speed Data Bus (HSDB) connection.



- **GDU 1240A-20/1040A-20** (1) – This unit is configured as a MFD that features a 12 or 10.4-inch LCD with 1024 x 768 resolution. The unit installed on the right/copilot side is designated as MFD. This unit communicates with the GDU 1240A-30/1040A-30 (PFD), and with the on-side GIA 63W Integrated Avionics Unit through a High-Speed Data Bus (HSDB) connection.



- **GIA 63W** (2) – The Integrated Avionics Units (IAU) function as the main communication hub, linking all LRUs with the PFD. Each GIA 63W contains a GPS Satellite-Based Augmentation System (SBAS) receiver, VHF COM/NAV/GS receivers, a flight director (FD; if the Garmin AFCS is installed) and system integration microprocessors. Each GIA 63W is paired with the on-side display via an HSDB connection. The GIA 63Ws are not paired and do not communicate with each other directly.



- **GDC 74A** (1 or 2) – The Air Data Computer (ADC) processes data from the pitot/static system and outside air temperature (OAT) sensor. This unit provides pressure altitude, airspeed, vertical speed and OAT information to the system, and it communicates with the primary GIA 63W, GDU 1240A and GRS 77, using an ARINC 429 digital interface (it also interfaces directly with the primary GTP 59).



- **GEA 71** (1) – Receives and processes signals from the engine and airframe sensors. This unit communicates with both GIA 63Ws using an RS-485 digital interface.



- **GRS 77** (1 or 2) – The Attitude and Heading Reference System (AHRS) provides aircraft attitude and heading information via ARINC 429 to both GDUs and the primary GIA 63W. The GRS 77 contains advanced sensors (including accelerometers and rate sensors) and interfaces with the primary GMU 44 to obtain magnetic field information, with the GDC 74A to obtain air data, and with both GIA 63Ws to obtain GPS information. AHRS modes of operation are discussed later in this document.



- **GMU 44** (1 or 2) – The Magnetometer measures local magnetic field and sends the data to the GRS 77 for processing to determine aircraft magnetic heading. This unit receives power directly from the GRS 77 and communicates with the GRS 77, using an RS-485 digital interface.



- **GMA 350** or **GMA 350c** or **GMA 347** (1) – The Audio Panel integrates NAV/COM audio, intercom, telephone, and marker beacon controls (refer to the Audio Panel & CNS Section). This unit communicates with both GIA 63Ws, using an RS-232 digital interface.



- **GTX 32** (1) or **GTX 33** (1) or **GTX 33 with Extended Squitter** (1) – The GTX 32 solid-state transponder provides Modes A and C capability. The GTX 33 solid-state transponder provides Modes A, C, and S capability. The GTX 33 may also be additionally be equipped with 1090 MHz Extended Squitter (1090ES) transmit capability. The PFD provides transponder controls. The transponder communicates with the primary GIA 63W through an RS-232 digital interface.



- **GTS 800** (1) (optional) – The GTS 800 provides real-time traffic information to the MFD (and, indirectly, to the inset map of the PFD). The GTS 800 communicates with the MFD with an HSDB connection. The GTS 800 also has an analog audio connection to the Audio Panel.



- **GDL 69/69A/69 SXM/69A SXM** (1) (optional) – The Data Link Satellite Radio Receiver provides weather information to the MFD (and, indirectly, to the inset map of the PFD) as well as digital audio entertainment. The unit communicates with the MFD via an HSDB connection. A subscription to the SiriusXM Satellite Radio and/or SiriusXM Weather service is required to enable the GDL 69/69A/69A SXM capabilities.



- **GDL 59** (1) (optional) – The GDL 59 is a Wi-Fi data link transceiver. Operation is performed on the MFD. The GDL 59 is connected to the GDL 69 (if installed) or to the MFD using HSDB. The GDL 59 also includes analog connections to the audio panel.



- **GSR 56** (1) (optional) – The Iridium Transceiver provides telephone voice communication by means of pilot and copilot headsets. The unit can also send and receive data over the Iridium satellite network. The GSR 56 is connected to the optional GDL 59 with an RS-232 digital interface and analog audio connections. Otherwise, the GSR 56 is connected the #1 GIA 63W with an RS-232 digital interface, with analog connections to the audio panel.



- **GCU 478** (1) – Provides the Flight Management System (FMS) controls for the PFD and MFD through an RS-232 digital interface.



- **GMC 705** (1) – Provides the controls for the Garmin AFCS through an RS-232 digital interface allowing communication with the PFD and MFD.



- **GTP 59** (1 or 2) – The Temperature Probe provides Outside Air Temperature (OAT) data to the primary GDC 74A.



- SYSTEM OVERVIEW
- FLIGHT INSTRUMENTS
- EIS
- AUDIO PANEL & CNS
- FLIGHT MANAGEMENT
- HAZARD AVOIDANCE
- AFCS
- ADDITIONAL FEATURES
- APPENDICES
- INDEX

- **GSA 80** (1), **GSA 81** (2), and **GSM 85A/86** (3) (optional) – The GSA 80 servo is used for the automatic control of yaw, while the GSA 81 servos are used for the automatic control of pitch and roll. These units interface with each GIA 63W. The GSM 85A/86 servo gearbox is responsible for transferring the output torque of the GSA 80/81 servo actuator to the mechanical flight-control surface linkage.

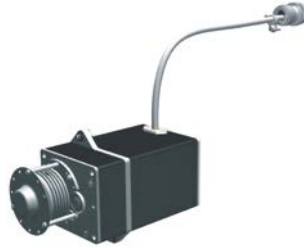

- **GTA 82** (1) (optional) – The Pitch Trim Adapter takes input from the trim switches, GIA 63W and GSA 81 to control the DC motor to drive the aircraft trim system.



- **GDL 88/88D** (1) (optional) – Provides ADS-B Traffic in and FIS-B Weather. It is connected to the PFD via HSDB.



- **Flight Stream 210** (1) (optional) – Provides wireless Bluetooth connectivity between a compatible tablet/mobile device and the avionics system. It is connected to the MFD using an RS-232 interface.



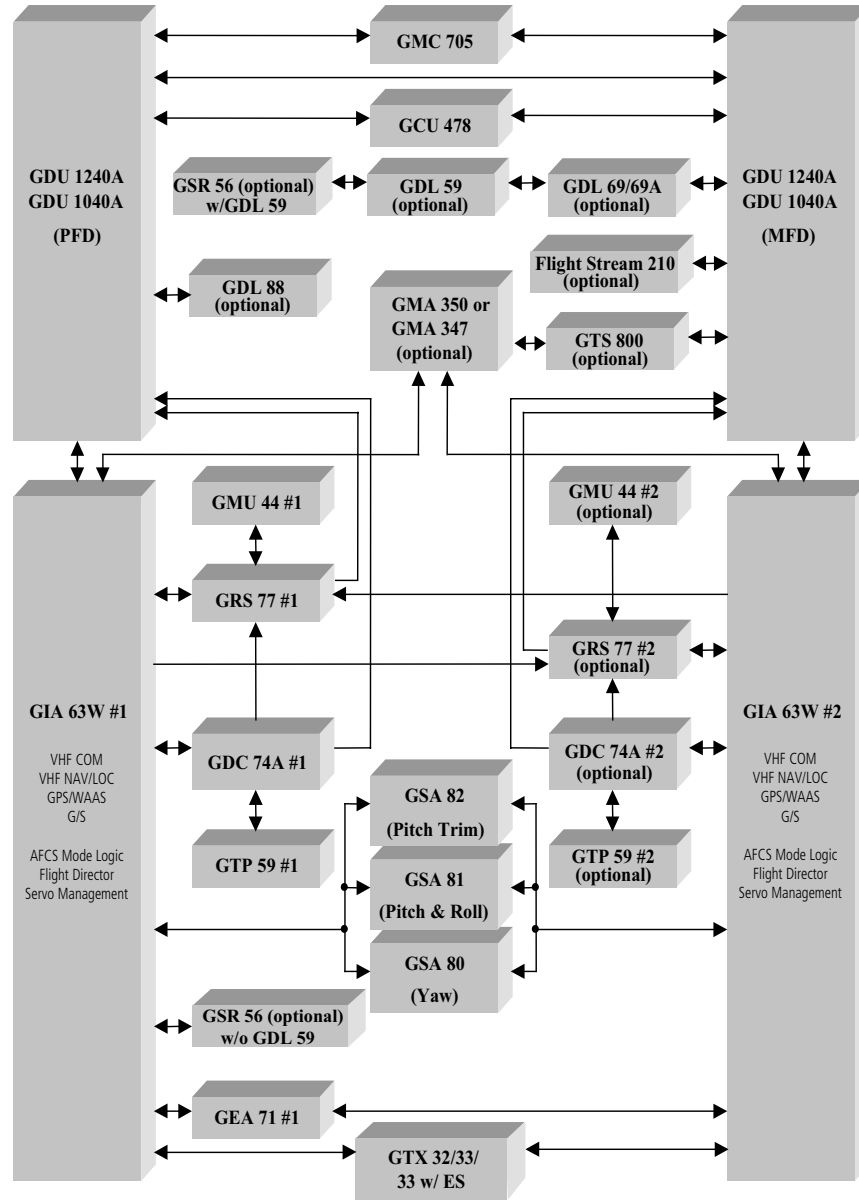

Figure 1-1 Perspective System (Example LRU Configuration)

SYSTEM OVERVIEW

FLIGHT INSTRUMENTS

EIS

AUDIO PANEL & CNS

FLIGHT MANAGEMENT

HAZARD AVOIDANCE

AFCS

ADDITIONAL FEATURES

APPENDICES

INDEX

1.2 SYSTEM CONTROLS

NOTE: The Audio Panel (GMA 347) and AFCS controls (GMC 705) are described in the Audio Panel & CNS and AFCS sections respectively.



The system controls are located on the PFD and MFD bezels, PFD/MFD Control Unit, AFCS Control Unit and audio panel. The controls for the PFD and MFD are discussed within the following pages of this section.

PFD/MFD CONTROLS



Figure 1-2 PFD & MFD Controls

The following list provides an overview of the controls located on the PFD and MFD bezel (see Figure 1-2).

- ① **COM Frequency Transfer Key** – Toggles the standby and active COM frequencies. Press and hold this key for two seconds to tune the emergency frequency (121.5 MHz) automatically into the active frequency field.
- ② **COM VOL/SQ Knob** – Controls COM audio volume level. Volume level is shown in the COM frequency field as a percentage. Push to turn the COM automatic squelch ON and OFF.
- ③ **COM Knob** – Tunes the standby frequencies for the COM transceiver (large knob for MHz; small knob for kHz). Push to switch the cyan tuning arrow  between COM1 and COM2.
- ④ **BARO Knob** – Sets the altimeter barometric pressure. Press to enter standard pressure (29.92).
- ⑤ **Joystick** – Changes the map range when rotated. Activates the map pointer when pushed. Moves the Quick Select Box or cursor on the 'FPL - Active Flight Plan' Page on the MFD when joystick is moved left, right, up, or down.
- ⑥ **MENU Key** – Displays a context-sensitive list of options. This list allows the user to access additional features or make setting changes that relate to particular pages.
- ⑦ **PROC Key** – Gives access to IFR departure procedures (DPs), arrival procedures (STARs) and approach procedures (IAPs) for a flight plan. If a flight plan is used, available procedures for the departure and/or arrival airport are automatically suggested. These procedures can then be loaded into the active flight plan. If a flight plan is not used, both the desired airport and the desired procedure may be selected.
- ⑧ **ENT Key** – Validates or confirms a menu selection or data entry.
- ⑨ **FMS Knob** – Flight Management System Knob. Push the **FMS** Knob to turn the selection cursor ON and OFF. When the cursor is ON, data may be entered in the applicable window by turning the small and large knobs. The large knob moves the cursor on the page, while the small knob selects individual characters for the highlighted cursor location.
- ⑩ **CLR Key** – Erases information, cancels entries, or removes page menus.
- ⑪ **FPL Key** – Displays the 'FPL - Active Flight Plan' Page for creating and editing the active flight plan.
- ⑫ **Direct-to Key** () – Allows the user to enter a destination waypoint and establish a direct course to the selected destination (the destination is either specified by the identifier, chosen from the active route, or taken from the map pointer position).
- ⑬ **Bezel Keys** – Used to select the appropriate softkey to access additional functionality.
- ⑭ **NAV Knob** – Tunes the standby frequencies for the NAV receiver (large knob for MHz; small knob for kHz). Push to switch the cyan tuning arrow  between NAV1 and NAV2.
- ⑮ **NAV VOL/ID Knob** – Controls NAV audio volume level. Push to toggle the Morse code identifier audio ON and OFF. Volume level is shown in the NAV frequency field as a percentage.
- ⑯ **NAV Frequency Transfer Key** – Toggles the standby and active NAV frequencies.

PFD/MFD CONTROL UNIT

The additional controls for the PFD and MFD are located on the PFD/MFD Control Unit (GCU 478). The following list provides an overview of the controls located on the PFD/MFD Control Unit:

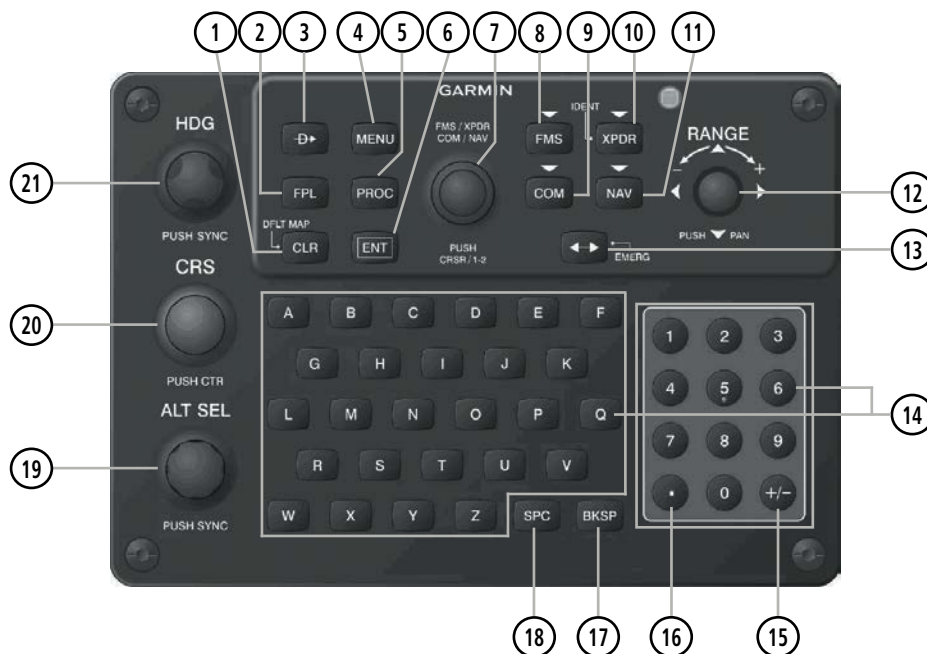

Figure 1-3 PFD/MFD Control Unit (GCU 478)

- ① **CLR Key** – Erases information, cancels entries, or removes page menus. Pressing and holding this key displays the ‘MAP - Navigation Map’ Page automatically.
- ② **FPL Key** – Displays the ‘FPL - Active Flight Plan’ Page for creating and editing the active flight plan, or for accessing stored flight plans.
- ③ **Direct-to Key (D>)** – Allows the user to enter a destination waypoint and establish a direct course to the selected destination (the destination is either specified by the identifier, chosen from the active route, or taken from the map pointer position).
- ④ **MENU Key** – Displays a context-sensitive list of options. This list allows the user to access additional features or make setting changes that relate to particular pages.
- ⑤ **PROC Key** – Gives access to IFR departure procedures (DPs), arrival procedures (STARs) and approach procedures (IAPs) for a flight plan. If a flight plan is used, available procedures for the departure and/or arrival airport are automatically suggested. These procedures can then be loaded into the active flight plan. If a flight plan is not used, both the desired airport and the desired procedure may be selected.
- ⑥ **ENT Key** – Validates or confirms a menu selection or data entry.
- ⑦ **FMS/XPDR/COM/NAV Knob** – Acts as the **FMS** Knob for the MFD. Sets the transponder code when in **XPDR** mode. Acts as the **COM** Knob when in COM tuning mode. Acts as the **NAV** Knob when in NAV tuning mode.

- ⑧ **FMS Key** – Selects/deselects FMS mode.
- ⑨ **COM Key** – Selects/deselects COM tuning mode.
- ⑩ **XPDR Key** – Selects/deselects XPDR mode.
- ⑪ **NAV Key** – Selects/deselects NAV tuning mode.
- ⑫ **Joystick** – Changes the map range when rotated. Activates the map pointer when pressed. Moves the Quick Select Box or cursor on the 'FPL - Active Flight Plan' Page on the MFD when joystick is moved left, right, up, or down.
- ⑬ **Frequency Transfer Key (EMERG)** – Transfers between active and standby COM or NAV tuning frequencies. Selects/deselects NAV tuning mode. Press and hold 2 seconds to tune the emergency frequency (121.5 MHz) automatically into the active frequency field.
- ⑭ **Alphanumeric Keys** – Allow the user to enter data quickly, without having to select individual characters with the **FMS Knob**. When the Quick Select Box is shown on the 'FPL - Active Flight Plan' Page on the MFD, alphanumeric keys can be used to enter data into the Quick Select Box area.
- ⑮ **Plus (+) Minus (-) Key** – Toggles a (+) or (-) character.
- ⑯ **Decimal Key** – Enters a decimal point.
- ⑰ **BKSP Key** – Moves the cursor back one character space.
- ⑱ **SPC Key** – Adds a space character.
- ⑲ **ALT SEL Knob** – Sets the selected altitude in the Selected Altitude Box. Pushing this knob synchronizes the selected altitude to the current altitude. In addition to providing the standard altitude alerter function, selected altitude provides an altitude setting for the Altitude Capture/Hold mode of the AFCS. The Selected Altitude Range Arc (when enabled), which appears on navigation maps during climbs or descents, is also based on the selected altitude setting.
- ⑳ **CRS Knob** – Sets the selected course on the HSI when the VOR1, VOR2, or OBS/SUSP mode is selected. Pushing this knob centers the CDI on the currently selected VOR. The selected course provides course reference to the flight director when operating in Navigation and Approach modes.
- ㉑ **HDG Knob** – Sets the selected heading on the HSI. Pushing this knob synchronizes the heading bug to the current heading. When operating in Heading Select mode, this knob provides the heading reference to the flight director.

GARMIN AFCS CONTROLS

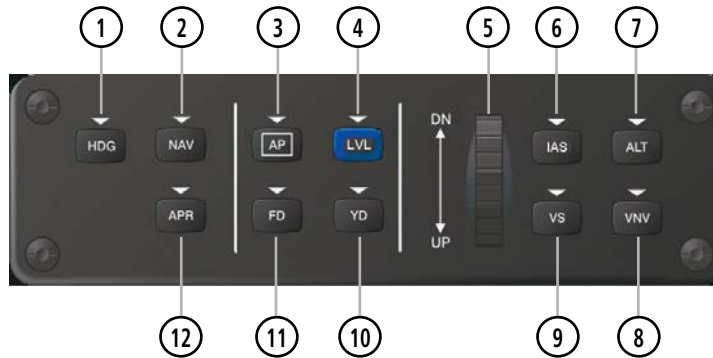

Figure 1-4 GMC 705 AFCS Control Unit



NOTE: If a key is selected, its respective annunciator is illuminated.

The Garmin AFCS is mainly controlled through the GMC 705 AFCS Control Unit. The AFCS Control Unit consists of the following controls:

- ① **HDG Key** – Selects/deselects Heading Select Mode.
- ② **NAV Key** – Selects/deselects Navigation Mode.
- ③ **AP Key** – Engages/disengages the autopilot.
- ④ **LVL Key** – Engages the autopilot (if the autopilot is disengaged and the aircraft is within the autopilot engagement limitations) in level vertical and lateral modes.



NOTE: The LVL Key will not engage the autopilot when Automatic Descent Mode (ADM) is active.

- ⑤ **NOSE UP/DN Wheel** – Controls the active mode reference for the Pitch, Vertical Speed, and Indicated Airspeed modes.
- ⑥ **IAS Key** – Selects/deselects Indicated Airspeed Mode.
- ⑦ **ALT Key** – Selects/deselects Altitude Hold Mode.
- ⑧ **VNV Key** – Selects/deselects Vertical Navigation mode.
- ⑨ **VS Key** – Selects/deselects Vertical Speed Mode.
- ⑩ **YD Key (optional)** – Engages/disengages the yaw damper.
- ⑪ **FD Key** – Activates/deactivates the flight director in the default pitch and roll modes. If the autopilot is engaged, the **FD Key** is disabled.
- ⑫ **APR Key** – Selects/deselects Approach Mode.

ADDITIONAL AFCS CONTROLS

The **AP DISC** (Autopilot Disconnect) Switch, **GA** (Go Around) Button, and **MET** (Manual Electric Trim) Switch are additional AFCS controls and are located in the cockpit, separately from the AFCS Control Unit. These are discussed in detail in the AFCS section.

GMA 350/350C AUDIO PANEL CONTROLS

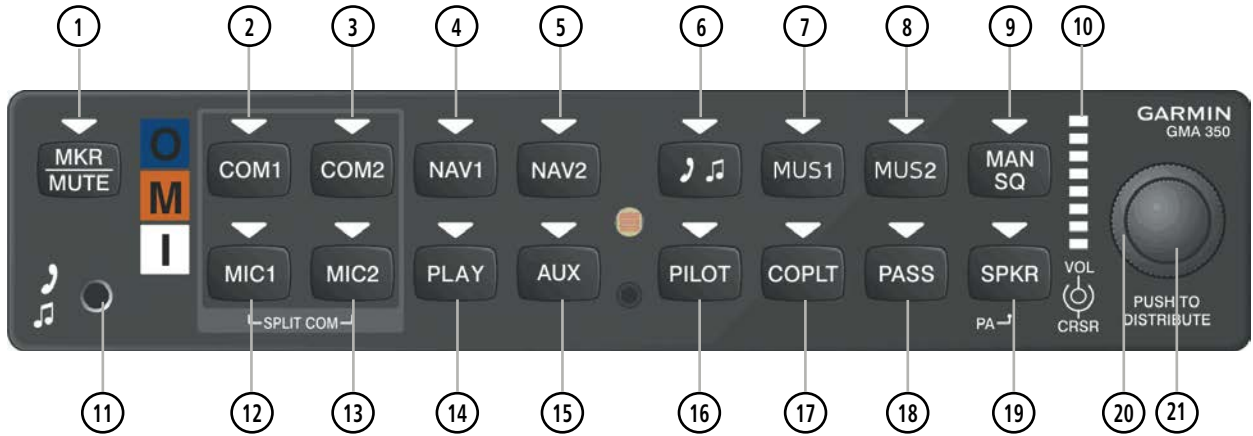

GMA 350 Controls

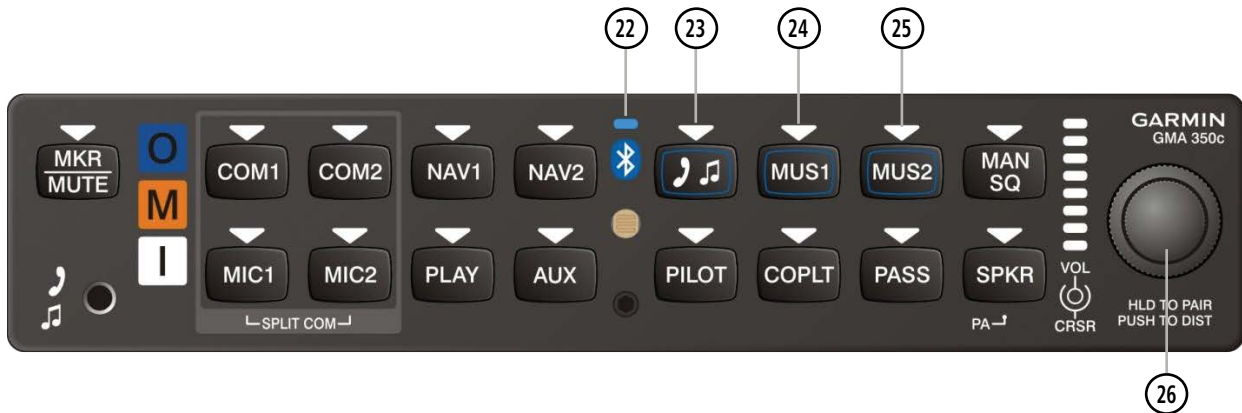



GMA 350c (Bluetooth) Controls

Figure 1-5 GMA 350/350c Audio Panel Controls



NOTE: When a key is selected, a triangular annunciator above the key is illuminated.

- ① **MKR/MUTE** – Selects marker beacon receiver audio. Mutes the currently received marker beacon receiver audio. Deactivates automatically and marker beacon audio is heard when the next marker beacon signal is received. Also, stops play of recorded COM audio.
- ② **COM1** – When selected, audio from the #1 COM receiver can be heard. Press and hold to enable/disable monitored COM muting during primary COM reception.

- ③ **COM2** – When selected, audio from the #2 COM receiver can be heard. Press and hold to enable/disable monitored COM muting during primary COM reception.
- ④ **NAV1** – When selected, audio from the #1 NAV receiver can be heard.
- ⑤ **NAV2** – When selected, audio from the #2 NAV receiver can be heard.
- ⑥  – Selects and deselects audio from a telephone or entertainment device connected to the Front Panel Jack. Audio from a telephone connected to the rear of the audio panel is used if a device is not connected to the Front Panel Jack. Press and hold to enable/disable  muting during reception.
- ⑦ **MUS1** – Selects and deselects music entertainment audio. Press and hold to enable/disable **MUS1** muting during reception.
- ⑧ **MUS2** – Selects and deselects music entertainment audio. Press and hold to enable/disable **MUS2** muting during reception.
- ⑨ **MAN SQ** – Manual Squelch annunciator. When lit, squelch is controlled manually.
- ⑩ **Volume Indicator** – Indicates volume/squelch setting relative to full scale.
- ⑪ **Front Panel Jack** – Used for an entertainment or telephone input.
- ⑫ **MIC1** – Selects the #1 transmitter for transmitting. COM1 receive is simultaneously selected when this key is pressed allowing received audio from the #1 COM receiver to be heard. COM2 receive can be added by pressing the **COM2** Key. Selection of a second MIC button initiates Split-COM mode. When in Split-COM mode, the pilot is using COM1, the copilot is using the COM2.
- ⑬ **MIC2** – Selects the #2 transmitter for transmitting. COM2 receive is simultaneously selected when this key is pressed allowing received audio from the #2 COM receiver to be heard. COM1 receive can be added by pressing the **COM1** Key. Selection of a second MIC button initiates Split-COM mode. When in Split-COM mode, the pilot is using COM1, the copilot is using the COM2.
- ⑭ **PLAY** – Press once to play the latest recorded memory block. Press while audio is playing begins playing the previously recorded memory block. Each subsequent press thereafter plays the previous block of memory.
- ⑮ **AUX** – When selected, audio from the ADF and DME (if equipped) can be heard.
- ⑯ **PILOT** – Controls the pilot intercom system. Press and hold to toggle 3D Audio on/off for all headset positions.
- ⑰ **COPLT** – Controls the copilot intercom system. Press and hold to toggle copilot configuration between crew and passenger.
- ⑱ **PASS** – Controls the passenger intercom system. Press and hold to enable/disable passenger muting during reception.

- ⑲ **SPKR** – Selects and deselects the cabin speaker. COM, NAV, AUX, and MKR receiver audio can be heard on the speaker. Press and hold for 2 seconds for Passenger Address (PA). The **SPKR** key flashes during PA.
- ⑳ **Cursor (CRSR) Control Knob** – Turn to move the cursor (flashing white or blue annunciator) to the desired source.
- ㉑ **Volume (VOL) Control Knob** – Turn the smaller knob to control volume or squelch of the selected source (indicated by the flashing white or blue annunciator). When the volume control cursor is not active press to switch to Blue-Select mode. If the volume control cursor is active, push twice (once to cancel the cursor, twice to activate Blue-Select mode).
- ㉒ **Bluetooth® Connection Annunciator** – (GMA 350c only) A flashing blue annunciator indicates the unit is discoverable. A solid blue annunciator indicates an active Bluetooth connection.
- ㉓ **🎵 Key Annunciator** – (GMA 350c only) Assigns the Bluetooth device to the 🎵 audio source. Press the 🎵 key until the annunciator turns blue. The key annunciator will cycle from OFF to WHITE to BLUE. WHITE selects the wired audio source and BLUE selects the Bluetooth audio source. **NOTE:** The Bluetooth audio can only be assigned to one source at a time. Once the Bluetooth audio is assigned to an audio source, the remaining entertainment audio sources will only cycle between OFF and WHITE.
- ㉔ **MUS1 Key Annunciator** – (GMA 350c only) Assigns the Bluetooth device to the **MUS1** audio source. Press the **MUS1** key until the annunciator turns blue. The key annunciator will cycle from OFF to WHITE to BLUE. WHITE selects the wired audio source and BLUE selects the Bluetooth audio source. **NOTE:** The Bluetooth audio can only be assigned to one source at a time. Once the Bluetooth audio is assigned to an audio source, the remaining entertainment audio sources will only cycle between OFF and WHITE.
- ㉕ **MUS2 Key Annunciator** – (GMA 350c only) Assigns the Bluetooth device to the **MUS2** audio source. Press the **MUS2** key until the annunciator turns blue. The key annunciator will cycle from OFF to WHITE to BLUE. WHITE selects the wired audio source and BLUE selects the Bluetooth audio source. **NOTE:** The Bluetooth audio can only be assigned to one source at a time. Once the Bluetooth audio is assigned to an audio source, the remaining entertainment audio sources will only cycle between OFF and WHITE.
- ㉖ **Control Knob** – (GMA 350c only) Push and hold for two seconds to enable the GMA 350c as discoverable for pairing. The Bluetooth Annunciator with flash to indicate that the unit is discoverable. The unit will remain discoverable for 90 seconds or until a successful pair is established. Once a successful pair is established, the audio “Bluetooth paired” is played.

GMA 347 AUDIO PANEL CONTROLS

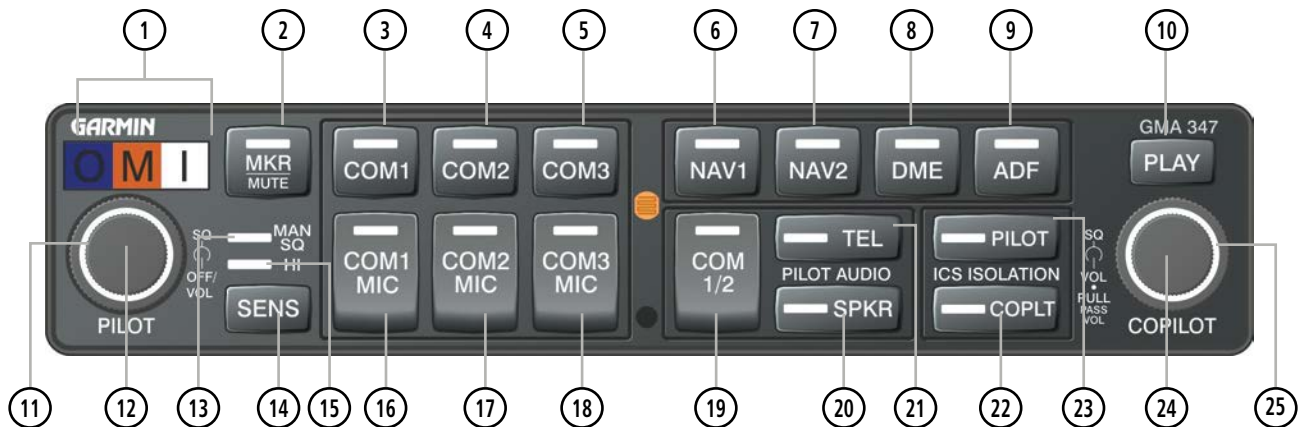

Figure 1-6 GMA 347 Audio Panel Controls

NOTE: When a key is selected, an annunciator in the key is illuminated.

- ① **Marker Beacon Annunciators** – Each annunciator lights independently when flying over the associated marker beacon station.
- ② **MKR/MUTE** – Selects marker beacon receiver audio. Mutes the currently received marker beacon receiver audio. Unmutes automatically when new marker beacon audio is received. Enables Music Mute feature. Also, stops play of recorded COM audio.
- ③ **COM1** – When selected, audio from the #1 COM receiver can be heard.
- ④ **COM2** – When selected, audio from the #2 COM receiver can be heard.
- ⑤ **COM3** – Reserved for optional COM radio.
- ⑥ **NAV1** – When selected, audio from the #1 NAV receiver can be heard.
- ⑦ **NAV2** – When selected, audio from the #2 NAV receiver can be heard.
- ⑧ **DME** – Turns optional DME audio on or off.
- ⑨ **ADF** – Turns optional ADF receiver audio on or off.
- ⑩ **PLAY** – Press once to play the last recorded COM audio. Press again while audio is playing and the previous block of recorded audio will be played. Each subsequent press plays each previously recorded block. Pressing the **MKR/MUTE** Key during play of a memory block stops play.
- ⑪ **PILOT Squelch** – Turn to adjust Pilot's squelch. The Pilots volume knob must be pressed to allow manual squelch adjustment.
- ⑫ **PILOT Volume** – Turn the left (Pilot) volume knob to control pilot's intercom volume and the ON and OFF function. (Full CCW detent is OFF) Push to switch between manual and automatic squelch control as indicated by illumination of the MAN SQ annunciator.

- ⑬ **MAN SQ** – Manual Squelch annunciator. When lit, pilot and copilot squelch knobs control manual squelch.
- ⑭ **SENS** – Press to increase marker beacon receiver sensitivity as indicated by illumination of the HI SENS annunciator. Press again to return to low sensitivity and extinguish the HI SENS annunciator.
- ⑮ **HI SENS Annunciator** – Indicates marker beacon receiver sensitivity, high sensitivity when illuminated, low sensitivity when extinguished.
- ⑯ **COM1 MIC** – Selects the #1 transmitter for transmitting. COM1 receive is simultaneously selected when this key is pressed allowing received audio from the #1 COM receiver to be heard. COM2 receive can be added by pressing the **COM2** Key.
- ⑰ **COM2 MIC** – Selects the #2 transmitter for transmitting. COM2 receive is simultaneously selected when this key is pressed allowing received audio from the #2 COM receiver to be heard. COM1 receive can be added by pressing the **COM1** Key.
- ⑱ **COM3 MIC** – Reserved for optional COM radio.
- ⑲ **COM 1/2** – Split COM operation key. When selected, the pilot uses the COM 1 transceiver and the copilot uses COM 2.
- ⑳ **SPKR** – Selects and deselects the cabin speaker. COM and NAV receiver audio can be heard on the speaker. Press and hold for 2 seconds for Passenger Address (PA). The **SPKR** key flashes during PA.
- ㉑ **TEL** – Selects and deselects telephone audio.
- ㉒ **COPLT** – Selects and deselects the copilot intercom isolation.
- ㉓ **PILOT** – Selects and deselects the pilot intercom isolation.
- ㉔ **COPILOT/PASS Volume** – Turn to adjust Copilot/Passenger intercom volume or squelch. Pulling the right volume knob controls passenger volume, pushing in controls Copilot volume.
- ㉕ **COPILOT/PASS Squelch** – Copilot and passenger share the squelch knob.

SOFTKEY FUNCTION

The softkeys are located along the bottoms of the displays. The softkeys shown depend on the softkey level or page being displayed. The bezel keys below the softkeys can be used to select the appropriate softkey. When a softkey is selected, its color changes to black text on gray background and remains this way until it is turned off, at which time it reverts to white text on black background. When a softkey function is disabled, the softkey label is subdued (dimmed).

Softkeys revert to the previous level after 45 seconds of inactivity.

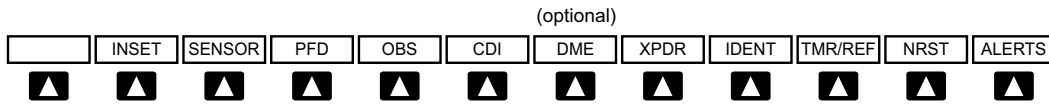

Figure 1-7 Softkeys (Second-Level PFD Configuration)

In the following descriptions, top level softkeys are denoted with bullets.

PFD SOFTKEYS

The PFD softkeys provide control over flight management functions, including GPS, NAV, terrain, traffic, and weather data (optional). Each softkey sublevel has a **BACK** Softkey which can be selected to return to the previous level. The **ALERTS** Softkey is visible at all softkey levels (label changes if messages are issued).



Press the **CDI** Softkey to cycle through navigation sources:
 - GPS
 - NAV1 (VOR/LOC)
 - NAV2 (VOR/LOC)

Figure 1-8 Top Level PFD Softkeys

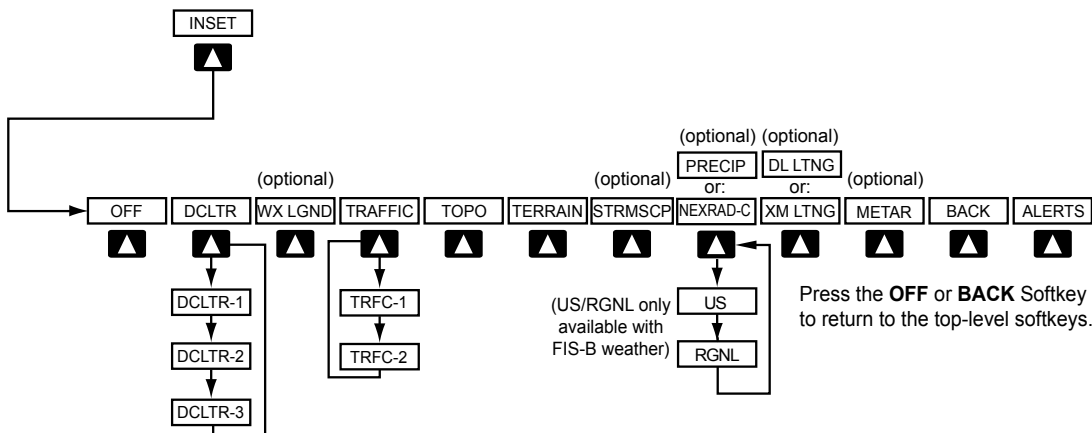
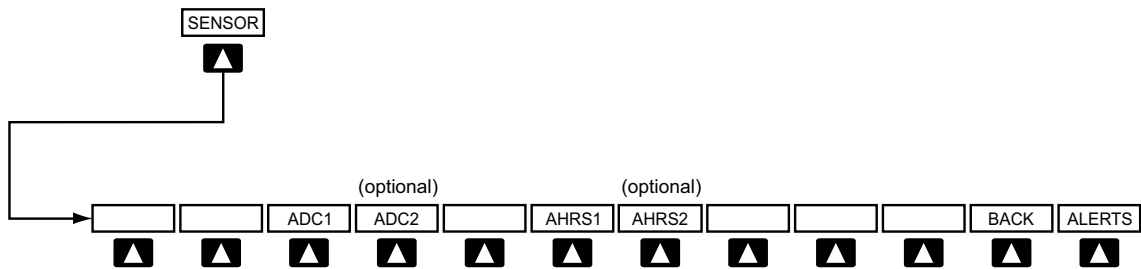

Figure 1-9 INSET Softkeys

Level 1	Level 2	Description
INSET		Displays Inset Map in PFD lower left corner
	OFF	Removes Inset Map
	DCLTR (3)	Selects desired amount of map detail; cycles through declutter levels: DCLTR (No Declutter): All map features visible DCLTR-1: Declutters land data DCLTR-2: Declutters land and special use airspace (SUA) data DCLTR-3: Removes everything except the active flight plan
	WX LGND	Displays icon and age on the Inset Map for the selected weather products (optional)
	TRAFFIC	Cycles through traffic display options: TRFC-1: Traffic displayed on inset map TRFC-2: 'MAP - Traffic Map' Page is displayed in the inset map window
	TOPO	Displays topographical data (e.g., coastlines, terrain, rivers, lakes) and elevation scale on Inset Map
	TERRAIN	Displays terrain information on Inset Map
	STRMSCP	Press to display the Stormscope lightning data on the Inset Map (within a 200 nm radius of the aircraft)
	NEXRAD-C	Displays SiriusXM NEXRAD-C weather and coverage on Inset Map (optional) When the GDL 88 is installed and FIS-B is the selected weather source, softkey cycles through NEXRAD-C coverage options on Inset Map (optional): US: Continental US NEXRAD-C weather displayed on Inset Map RGNL: Regional NEXRAD-C weather displayed on Inset Map
	or PRECIP	Displays/removes Garmin Connex radar precipitation and radar coverage information on Inset Map (optional)
	XM LTNG	Displays XM lightning information on the Inset Map (optional)
	or DL LTNG	Displays Connex Weather lightning information on the Inset Map (optional)
	METAR	Displays METAR flags for the airport symbols on the Inset Map (optional)



Press the **BACK** Softkey to return to the top-level softkeys.

Figure 1-10 SENSOR Softkeys

Level 1	Level 2	Description
SENSOR		Displays softkeys for selecting the #1 and #2 AHRS and Air Data Computers (only available when optional ADC2 and AHRS2 are installed)
	ADC1	Selects the #1 Air Data Computer
	ADC2	Selects the optional #2 Air Data Computer
	AHRS1	Selects the #1 AHRS
	AHRS2	Selects the optional #2 AHRS

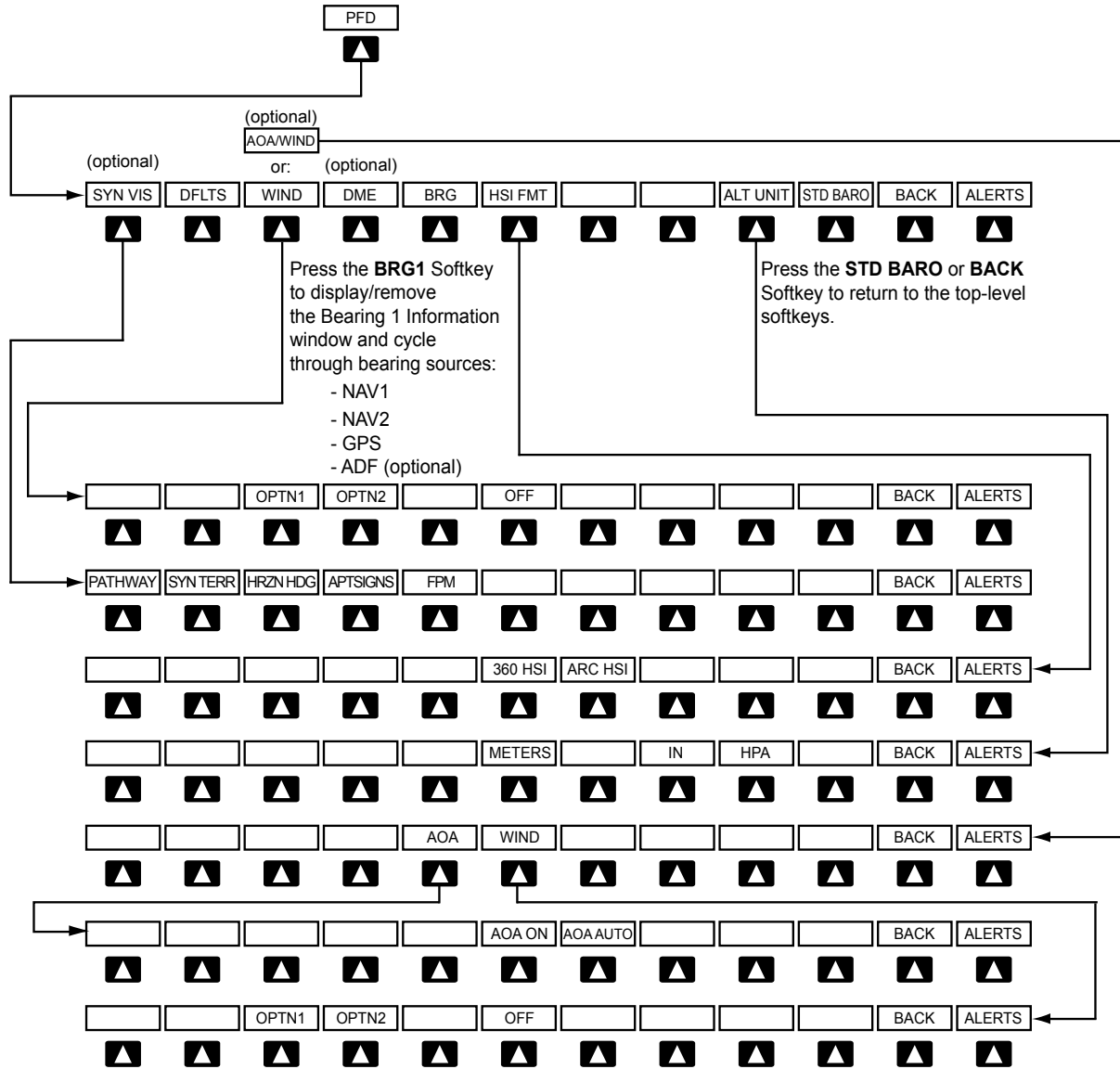

Figure 1-11 First PFD Softkey Level

Level 1	Level 2	Level 3	Level 4	Description
PFD				Displays second-level softkeys for additional PFD configurations
	SYN VIS			Displays the softkeys for enabling or disabling Synthetic Vision features
		PATHWAY		Displays rectangular boxes representing the horizontal and vertical flight path of the active flight plan
		SYN TERR		Enables synthetic terrain depiction
		HRZN HDG		Displays compass heading along the Zero-Pitch line
		APTSIGNS		Displays position markers for airports within approximately 15 nm of the current aircraft position. Airport identifiers are displayed when the airport is within approximately 9 nm.
		FPM		Enables the Flight Path Marker when SVT is disabled. HRZN HDG must be enabled.
	DFLTS			Resets PFD to default settings, including changing units to standard
AOA and Wind Softkeys shown if optional Angle of Attack Sensor is installed:				
	AOA/WIND			Displays the second-level softkeys for displaying Angle of Attack (AOA) Indicator and wind information.
		AOA		Shows softkeys for controlling the display of the AOA Indicator (optional).
			AOA ON	Enables/disables the display of the AOA Indicator on the PFD.
			AOA AUTO	When selected, AOA Indicator automatically appears when the AOA is greater than 0.2, or the flaps are extended.
		WIND		Displays softkeys to select wind data parameters
			OPTN 1	Wind direction arrow with direction and speed
			OPTN 2	Wind direction arrows with headwind and crosswind components
			OFF	Wind information not displayed
Wind Softkeys shown without Angle of Attack Sensor installed:				
	WIND			Displays the second-level softkeys for displaying wind information.
		OPTN 1		Wind direction arrow with direction and speed
		OPTN 2		Wind direction arrows with headwind and crosswind components
		OFF		Wind information not displayed

- SYSTEM OVERVIEW
- FLIGHT INSTRUMENTS
- EIS
- AUDIO PANEL & CNS
- FLIGHT MANAGEMENT
- HAZARD AVOIDANCE
- AFCS
- ADDITIONAL FEATURES
- APPENDICES
- INDEX

Level 1	Level 2	Level 3	Level 4	Description
	DME			Select to display the DME information window (optional)
	BRG			Cycles the Bearing Information Window through NAV1, NAV2 (omitted if BRG2 installed) or GPS/waypoint identifier and GPS-derived distance information, and ADF. All Bearing labels will be labeled BRG1 if BRG2 is installed.
	HSI FRMT			Displays the HSI formatting softkeys
		360 HSI		Displays the HSI in a 360 degree format
		ARC HSI		Displays the HSI in an arc format
	ALT UNIT			Displays softkeys for setting the altimeter and BARO settings to metric units
		METERS		When enabled, displays altimeter in meters
		IN		Select to display the BARO setting as inches of mercury
		HPA		Select to display the BARO setting as hectopascals
	STD BARO			Sets altimeter setting to standard barometric pressure

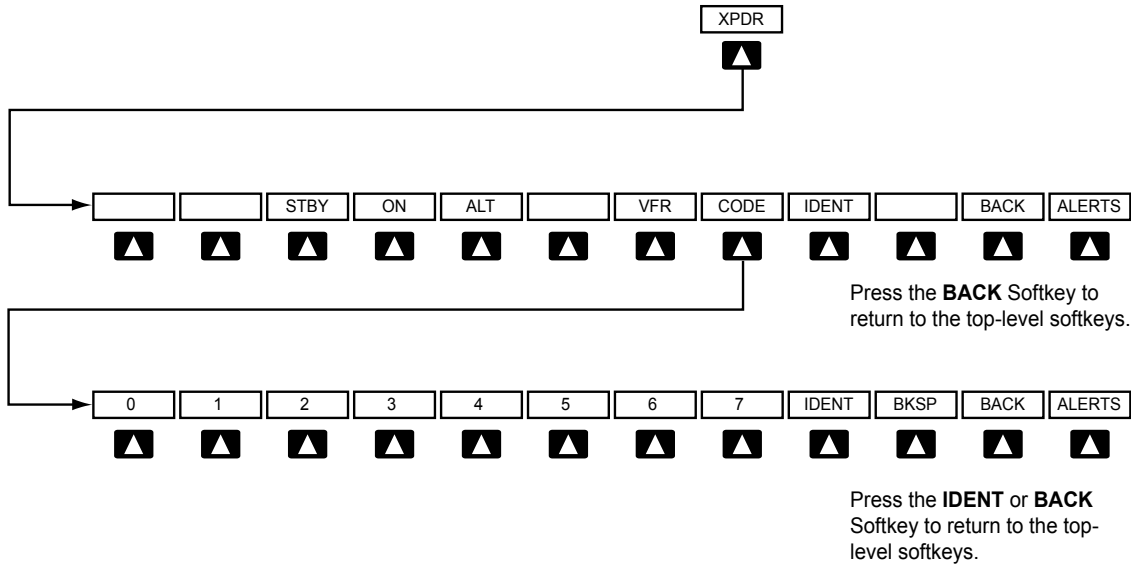

Figure 1-12 XPDR Softkeys

Level 1	Level 2	Level 3	Description
XPDR			Displays transponder mode selection softkeys
	STBY		Selects Standby Mode (transponder does not reply to any interrogations)
	ON		Selects Mode A (transponder replies to interrogations)
	ALT		Selects Mode C – Altitude Reporting Mode (transponder replies to identification and altitude interrogations)
	VFR		Automatically enters the VFR code (1200 in the U.S.A. only)
	CODE		Displays transponder code selection softkeys 0-7
		0 - 7	Use numbers to enter code
		BKSP	Removes numbers entered, one at a time
IDENT			Activates the Special Position Identification (SPI) pulse for 18 seconds, identifying the transponder return on the ATC screen
TMR/REF			Displays Timer/References Window
NRST			Displays Nearest Airports Window
ALERTS			Displays the Alerts Window

MFD SOFTKEYS

MFD softkeys vary depending on the page selected. 'EIS - Engine' and 'MAP - Navigation Map' Page (default MFD page) softkeys are described here.



NOTE: The ice protection system (optional) must be operated in accordance with pertinent flight manual limitations. This option is only available on SR22 models.

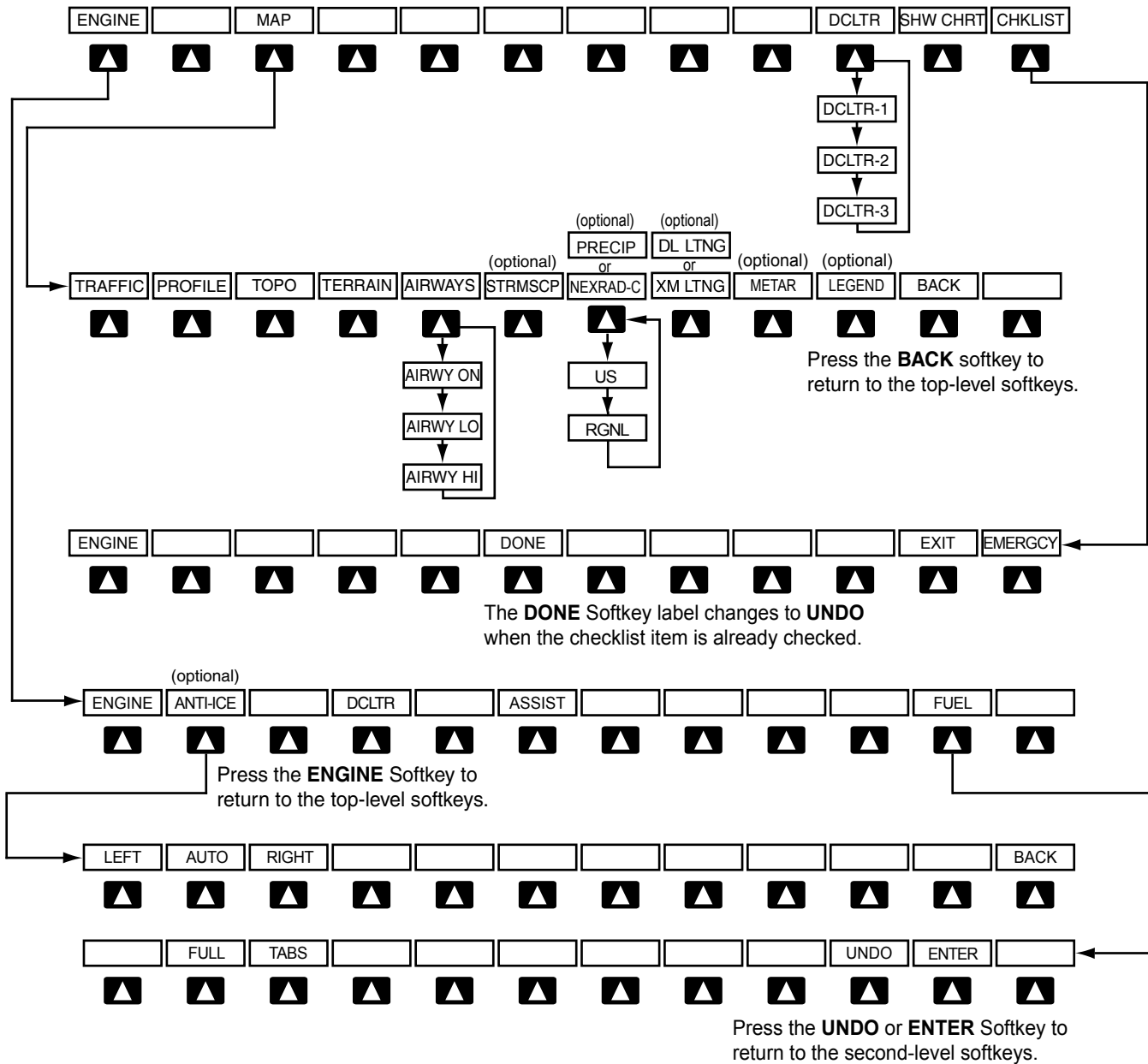





Figure 1-13 MFD Softkeys

Level 1	Level 2	Level 3	Description
ENGINE			Displays full 'EIS - Engine' Page and second-level engine softkeys; press again to return to the Engine Strip and top-level softkeys
	ANTI-ICE		Displays Anti-ice softkeys (optional-FIKI only)
		LEFT	Selects manual mode and opens the left tank valve and closes the right tank valve
		AUTO	Selects Auto Tank Mode
		RIGHT	Selects manual mode and opens the right tank valve and closes the left tank valve
	DCLTR		Declutters the Engine Temperatures Box removing bars and temperatures readouts
	ASSIST		Identifies temperature peaks
	FUEL		Accesses the 'Initial Usable Fuel' Page
		FULL	Resets fuel totalizer to full (<i>usable fuel</i>)
		TABS	Resets fuel totalizer to tabs (<i>usable fuel</i>)
		UNDO	Rejects the last entry and resets to the previous entry
		ENTER	Saves the usable fuel amount shown on the 'Initial Usable Fuel' Page
MAP			Enables second-level Navigation Map softkeys
	TRAFFIC		Displays traffic information on Navigation Map
	PROFILE		Displays/removes Profile View on 'MAP - Navigation Map' Page
	TOPO		Displays topographical data (e.g., coastlines, terrain, rivers, lakes) and elevation scale on Navigation Map
	TERRAIN		Displays terrain information on Navigation Map
	AIRWAYS		Displays airways on the map; cycles through the following: AIRWAYS: No airways are displayed AIRWY ON: All airways are displayed AIRWY LO: Only low altitude airways are displayed AIRWY HI: Only high altitude airways are displayed
	STRMSCP		Displays on-board lightning detection system information on the Navigation Map (optional feature).
	NEXRAD-C		Displays SiriusXM NEXRAD-C weather and coverage on Inset Map (optional) When the GDL 88 is installed and FIS-B is the selected weather source, softkey cycles through NEXRAD-C coverage options on Inset Map (optional): US: Continental US NEXRAD-C weather displayed on Inset Map RGNL: Regional NEXRAD-C weather displayed on Inset Map
	or PRECIP		Displays/removes Garmin Connex radar precipitation and radar coverage information on Inset Map (optional)

- SYSTEM OVERVIEW
- FLIGHT INSTRUMENTS
- EIS
- AUDIO PANEL & CNS
- FLIGHT MANAGEMENT
- HAZARD AVOIDANCE
- AFCS
- ADDITIONAL FEATURES
- APPENDICES
- INDEX

Level 1	Level 2	Level 3	Description
	XM LTNG or DL LTNG		Displays SiriusXM lightning information on the Navigation Map (optional) Displays Connex Weather lightning information on the Navigation Map (optional)
	METAR		Displays METAR flags on airport symbols shown on the Navigation Map (optional)
	LEGEND		Displays the legend for the selected weather products. Available only when NEXRAD, XM LTNG, and/or METAR softkeys are selected.
	BACK		Returns to top-level softkeys
DCLTR (3)			Selects desired amount of map detail; cycles through declutter levels: DCLTR (No Declutter): All map features visible DCLTR-1: Declutters land data DCLTR-2: Declutters land and SUA data DCLTR-3: Removes everything except the active flight plan
SHW CHRT			When available, displays optional airport and terminal procedure charts
CHKLIST			When available, displays optional checklists
	DONE		Selects the highlighted checklist item
	EXIT		Returns to the top-level softkeys
	EMERGCY		Immediately accesses the emergency procedures

1.3 SYSTEM POWER-UP

-  **NOTE:** Refer to the Appendices for AHRS initialization bank angle limitations.
-  **NOTE:** See the Appendices for additional information regarding system-specific annunciations and alerts.
-  **NOTE:** See the pertinent flight manual for specific procedures concerning avionics power application and emergency power supply operation.

The Perspective® system is integrated with the aircraft electrical system and receives power directly from electrical busses. The PFD, MFD and supporting sub-systems include both power-on and continuous built-in test features that exercise the processor, system memory, external inputs and outputs to provide safe operation.

During system initialization, test annunciations appear, as shown in Figure 1-14. All system annunciations should disappear typically within one minute of power-up. Upon power-up, key annunciator lights also become momentarily illuminated on the audio panels, the control units and the display bezels.

On the PFD, the AHRS initializes and displays 'AHRS ALIGN: Keep Wings Level'. The AHRS should display valid attitude and heading fields typically within one minute of power-up. The AHRS can align itself both while taxiing and during level flight.

When the MFD powers up (Figure 1-15), the MFD Power-up Page shows the following information:

- System version
- Copyright
- Checklist File
- Basemap database name and version
- SafeTaxi database and expiration date
- Terrain database name and version
- Obstacle database name and expiration date
- Navigation database name and expiration date
- Airport Directory name and expiration date
- FliteCharts/ChartView name and expiration date
- Pilot Profile

Current database information includes the valid operating dates, cycle number and database type. When this information has been reviewed for currency (to ensure that no databases have expired), the pilot is prompted to continue. Pressing the **ENT** Key acknowledges this information and the 'MAP - Navigation Map' Page is displayed upon pressing the key a second time. When the system has acquired a sufficient number of satellites to determine a position, the aircraft's current position is shown on the 'MAP - Navigation Map' Page.



Figure 1-14 PFD Initialization

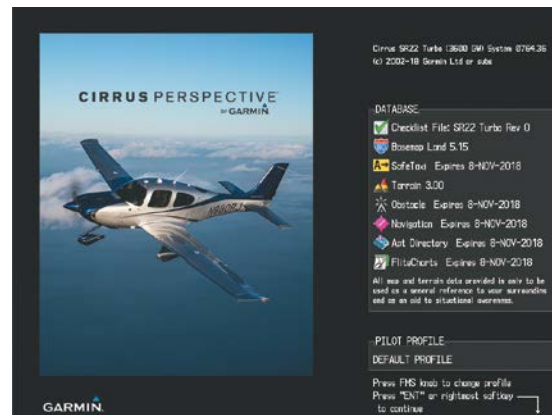

Figure 1-15 MFD Power-up Page

1.4 SYSTEM OPERATION

The displays are connected together via a single Ethernet bus, thus allowing for high-speed communication. As shown in Figure 1-1, each IAU is connected to the on-side display. This section discusses the normal and reversionary modes of operation as well as the various AHRS modes of the system.

DISPLAY OPERATION

NOTE: In normal operating mode, backlighting can only be adjusted from the PFD, or from any display operating in reversionary mode.

In normal operating mode, the PFD presents graphical flight instrumentation (attitude, heading, airspeed, altitude, vertical speed), replacing the traditional flight instrument cluster (see the Flight Instruments Section for more information). The MFD normally displays a full-color moving map with navigation information (see the Flight Management Section), while the left portion of the MFD is dedicated to the Engine Indication System (EIS; see the EIS Section). The PFD offers control for COM frequency selection and the MFD offers control for NAV frequency selection. The PFD/MFD Control Unit offers control for both COM and NAV frequency selection.



Figure 1-16 Normal Operation

- SYSTEM OVERVIEW
- FLIGHT INSTRUMENTS
- EIS
- AUDIO PANEL & CNS
- FLIGHT MANAGEMENT
- HAZARD AVOIDANCE
- AFCS
- ADDITIONAL FEATURES
- APPENDICES
- INDEX

In the event of a display failure, the system automatically switches to reversionary (backup) mode. In Reversionary Mode, all essential flight information from the PFD is combined with the EIS and presented on the display operating in Reversionary Mode. EIS operation while in Reversionary Mode is discussed in the EIS Section. As when the PFD is operating normally, windows for flight planning, nearest airports, and procedures are available. The Inset Map is moved to the right side of the display.

If a display fails, the appropriate IAU-display Ethernet interface is cut off. Thus, the IAU can no longer communicate with the remaining display (refer to Figure 1-1), and the NAV and COM functions provided to the failed display by the IAU are flagged as invalid on the remaining display. The system reverts to backup paths for the AHRS, ADC, Engine/Airframe Unit, and Transponder, as required. The change to backup paths is completely automated for all LRUs and no pilot action is required.

If the system fails to detect a display problem, Reversionary Mode may be manually activated by pressing the red **DISPLAY BACKUP** Button. Pressing this button again deactivates Reversionary Mode.



Figure 1-17 Reversionary Mode (Failed PFD)



NOTE: The system alerts the pilot when the LRUs use backup paths. Refer to the Appendices for further information regarding system-specific alerts.

SYSTEM ANNUNCIATIONS

When an LRU or an LRU function fails, a large red 'X' is typically displayed over the instrument experiencing failed data (Figure 1-18 displays failure annunciations with responsible LRUs). The system alerts the pilot when the LRUs are using backup paths. Upon power-up, certain instruments remain invalid as equipment begins to initialize. All instruments should be operational within one minute of power-up. If any instrument remains flagged, the system should be serviced by a Garmin-authorized repair facility.



NOTE: For a detailed description of all annunciations and alerts, refer to Appendix A. Refer to the pertinent flight manual for additional information regarding pilot responses to these annunciations.

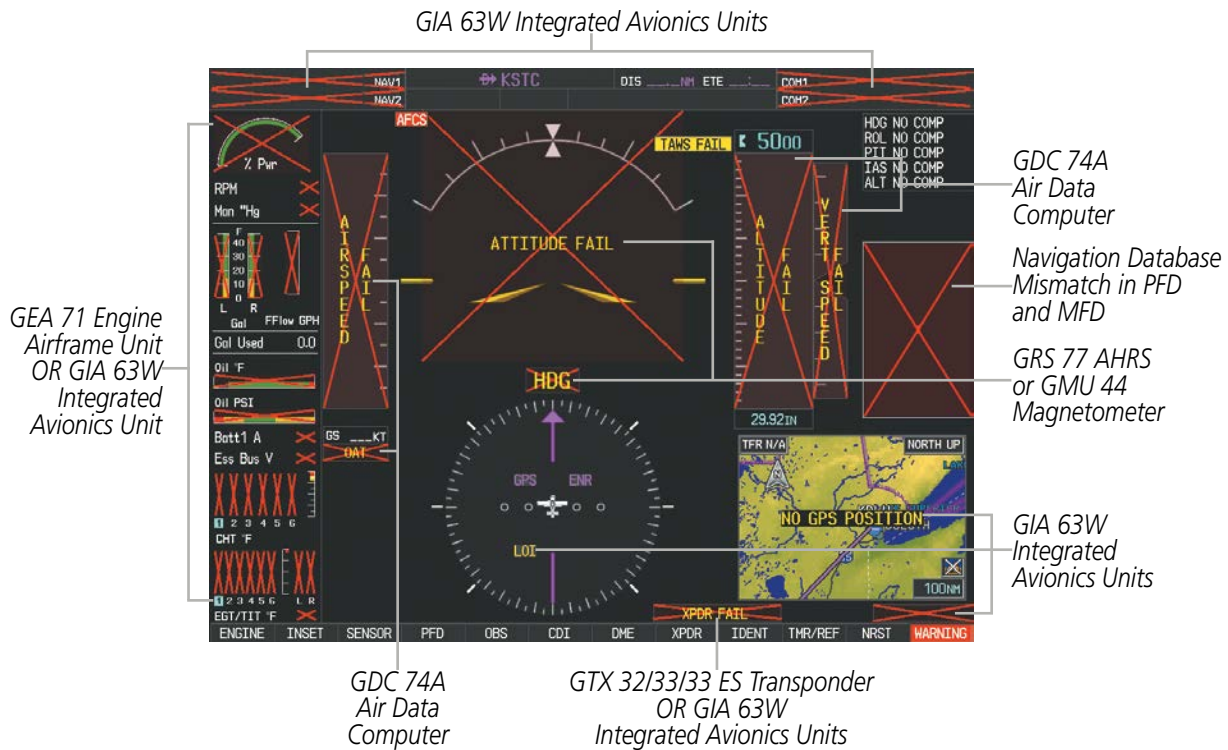

Figure 1-18 System Failure Annunciations

SYSTEM STATUS

The ‘AUX - System Status’ Page displays the status and software version numbers for all detected system LRUs. Pertinent information on all system databases is also displayed. Active LRUs are indicated by green check marks and failed LRUs are indicated by red “X”s. Note failed LRUs and inform a Cirrus service center or Garmin dealer.



Figure 1-19 Example ‘AUX - System Status’ Page

The **LRU** and **ARFRM** softkeys on the ‘AUX - System Status’ Page select the applicable list (LRU INFO or AIRFRAME window) through which the **FMS** Knob can be used to scroll information within the selected window.

Pressing the **MFD1 DB** Softkey (label background changes to grey indicating the softkey is selected) places the cursor in the DATABASE window. Use the **FMS** Knob to scroll through database information for the MFD. Pressing the softkey again will change the softkey label to **PFD1 DB**. PFD 1 database information is now displayed in the DATABASE window.

The **STBY DB** Softkey, when available on the ‘AUX - System Status’ Page, makes the standby navigation database become the active navigation database on the next power cycle. Refer to the Database Management section in the Appendices for more information.

The **ANN TEST** Softkey, when enabled, causes the system to issue a continuous double chime audio alert. In addition, the annunciator lights on the GMC 705 and GCU 478 controllers illuminate. To silence the audio alert and extinguish the annunciator lights, press the **ANN TEST** Softkey again.

AHRS OPERATION

NOTE: Aggressive maneuvering in reversionary mode can degrade AHRS accuracy.

The Attitude and Heading Reference System (AHRS) performs attitude, heading, and vertical acceleration calculations for the system, using GPS, magnetometer, and air data in addition to information from its internal sensors. Attitude and heading information are updated on the PFD while the AHRS receives appropriate combinations of information from the external sensor inputs.

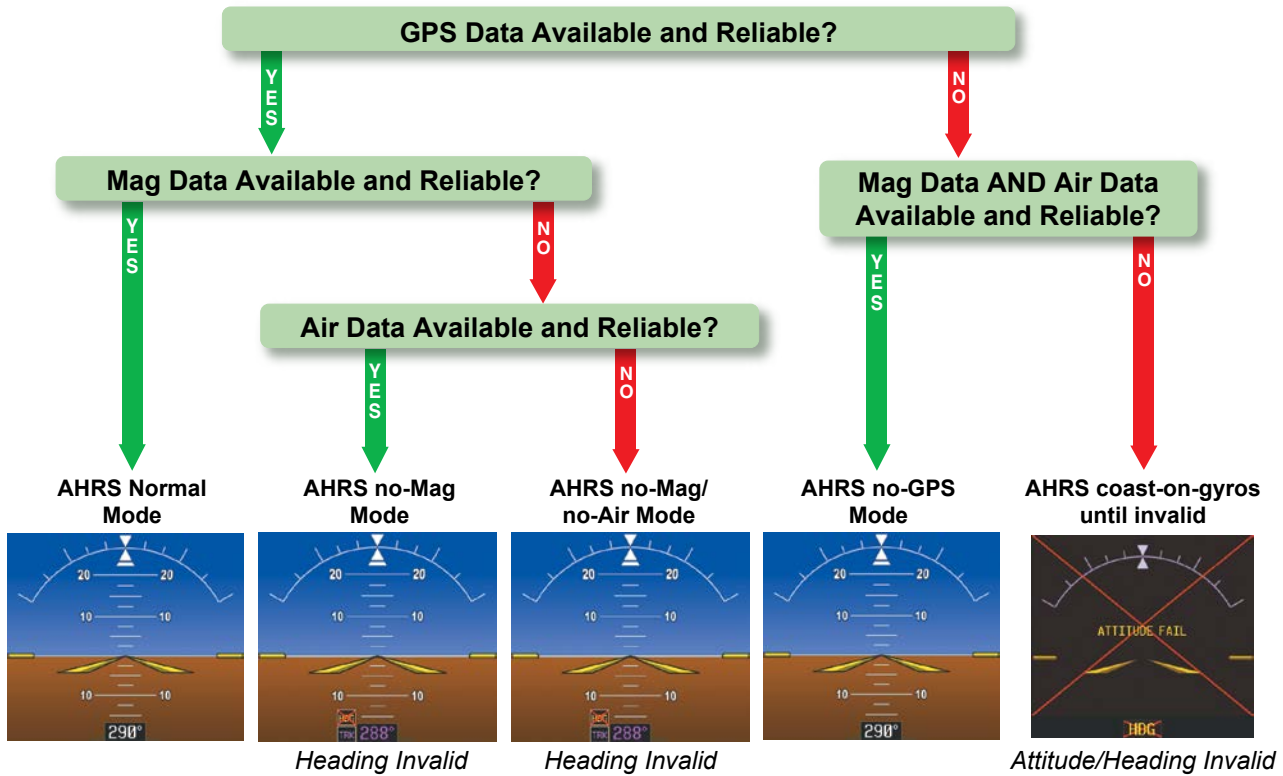

Figure 1-20 AHRS Operation

Loss of GPS, magnetometer, or air data inputs is communicated to the pilot by message advisory alerts (refer to Appendix A for specific AHRS alert information). Any failure of the internal AHRS inertial sensors results in loss of attitude and heading information (indicated by red 'X' indications over the corresponding flight instruments).

Two GPS inputs are provided to the AHRS. If GPS information from one of the inputs fails, the AHRS uses the remaining GPS input and an alert message is issued to inform the pilot. If both GPS inputs fail, the AHRS can continue to provide attitude and heading information to the PFD as long as magnetometer and airspeed data are available and valid.

If the magnetometer input fails, the AHRS continues to output valid attitude information. If GPS-based track information is available while magnetometer input has failed, the HSI displays the ground track instead of heading using HSI Track Mode. In this mode, a magenta 'TRK' annunciation and track readout appear on the

HSI. In addition, an amber 'HDG' annunciation with a red X appear above the 'TRK' annunciation to indicate the HSI is displaying track instead of heading.

If both the heading and track are unavailable, the HSI displays an amber 'HDG' annunciation with a red X over the heading readout box. The system also removes directional numbers and letters from the HSI.



HSI Track Mode (Heading Unavailable, Track Available)



Heading and Track Unavailable

Figure 1-21 Heading Failure Displays on the HSI

Failure of the air data input has no effect on the AHRS output while AHRS is receiving valid GPS information. Invalid/unavailable airspeed data in addition to GPS failure results in loss of all attitude and heading information.

The AHRS (GRS 77) corrects for shifts and variations in the Earth's magnetic field by applying the Magnetic Field Variation Database. The Magnetic Field Variation Database is derived from the International Geomagnetic Reference Field (IGRF). The IGRF is a mathematical model that describes the Earth's main magnetic field and its annual rate of change. The database is updated approximately every five years. See the Appendices for information on updating the Magnetic Field Variation Database. The system will prompt the pilot on startup when an update is available. Failure to update this database could lead to erroneous heading information being displayed to the pilot.

GPS RECEIVER OPERATION

Each GIA 63W Integrated Avionics Unit (IAU) contains a GPS receiver. Information collected by the specified receiver (GPS1 for the #1 IAU or GPS2 for the #2 IAU) may be viewed on the 'AUX - GPS Status' Page.

Internal system checking is performed to ensure both GPS receivers are providing accurate data to the PFD. In some circumstances, both GPS receivers may be providing accurate data, but one receiver may be providing a better GPS solution than the other receiver. In this case the GPS receiver producing the better solution is automatically coupled to the PFD. "BOTH ON GPS 1" or "BOTH ON GPS 2" are then displayed in the Reversionary Sensor Window (see Appendix A) indicating which GPS receiver is being used. Both GPS receivers are still functioning properly, but one receiver is performing better than the other at that particular time.

These GPS sensor annunciations are most often seen after system power-up when one GPS receiver has acquired satellites before the other, or one of the GPS receivers has not yet acquired an SBAS (Satellite Based Augmentation System) signal. While the aircraft is on the ground, the SBAS signal may be blocked by obstructions causing one GPS receiver to have difficulty acquiring a good signal. Also, while airborne, turning the aircraft may result in one of the GPS receivers temporarily losing the SBAS signal.

If the sensor annunciation persists, check for a system failure message in the Messages Window on the PFD. If no failure message exists, check the 'AUX - GPS Status' Page and compare the information for GPS1 and GPS2. Discrepancies may indicate a problem.

Viewing GPS receiver status information:

- 1) Turn the large **FMS** Knob on the MFD to select the 'AUX' Page Group (see Section 1.6 for information on navigating MFD page groups).
- 2) Turn the small **FMS** Knob to select 'AUX - GPS Status' Page.
- 3) To change the selected GPS receiver:
Press the desired **GPS** Softkey.

Or:

- a) Press the **MENU** Key.
- b) Use the **FMS** Knob to highlight the receiver which is not selected and press the **ENT** Key.

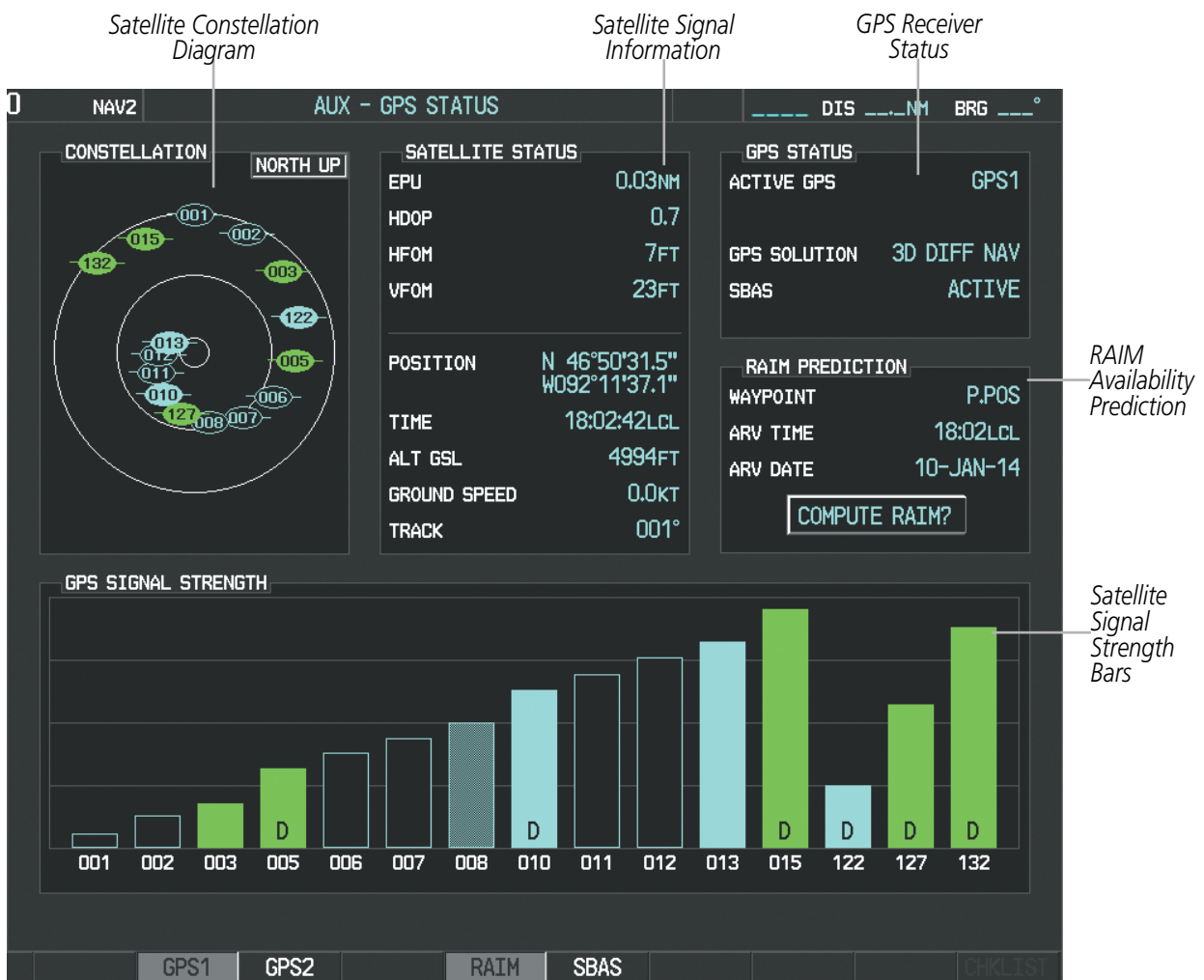

Figure 1-22 'AUX - GPS Status' Page

The 'AUX - GPS Status' Page provides the following information:

- Satellite constellation diagram

Satellites currently in view are shown at their respective positions on a sky view diagram. The sky view is always in a north-up orientation, with the outer circle representing the horizon, the inner circle representing 45° above the horizon, and the center point showing the position directly overhead.

Each satellite is represented by an oval containing the Pseudo-random noise (PRN) number (i.e., satellite identification number). Satellites whose signals are currently being used are represented by solid ovals.

- Satellite signal information status

The accuracy of the aircraft's GPS fix is calculated using Estimated Position Uncertainty (EPU), Dilution of Precision (DOP), and horizontal and vertical figures of merit (HFOM and VFOM). EPU is the radius of a circle centered on an estimated horizontal position in which actual position has 95% probability of laying. EPU is a statistical error indication and not an actual error measurement.

DOP measures satellite geometry quality (i.e., number of satellites received and where they are relative to each other) on a range from 0.0 to 9.9, with lower numbers denoting better accuracy. HFOM and VFOM, measures of horizontal and vertical position uncertainty, are the current 95% confidence horizontal and vertical accuracy values reported by the GPS receiver.

The current calculated GPS position, time, altitude, ground speed, and track for the aircraft are displayed below the satellite signal accuracy measurements.

- GPS receiver status

The GPS solution type (ACQUIRING, 2D NAV, 2D DIFF NAV, 3D NAV, 3D DIFF NAV) for the active GPS receiver (GPS1 or GPS2) is shown in the upper right of the 'AUX - GPS Status' Page. When the receiver is in the process of acquiring enough satellite signals for navigation, the receiver uses satellite orbital data (collected continuously from the satellites) and last known position to determine the satellites that should be in view. ACQUIRING is indicated as the solution until a sufficient number of satellites have been acquired for computing a solution.

When the receiver is in the process of acquiring a 3D differential GPS solution, 3D NAV is indicated as the solution until the 3D differential fix has finished acquisition. SBAS (Satellite-Based Augmentation System) indicates INACTIVE. When acquisition is complete, the solution status indicates 3D DIFF NAV and SBAS indicates ACTIVE.

- RAIM (Receiver Autonomous Integrity Monitoring) Prediction (**RAIM** Softkey is pressed)

In most cases performing a RAIM prediction is not necessary. However, in some cases, the selected approach may be outside the SBAS coverage area and it may be necessary to perform a RAIM prediction for the intended approach.

Receiver Autonomous Integrity Monitoring (RAIM) is a GPS receiver function that performs a consistency check on all tracked satellites. RAIM ensures that the available satellite geometry allows the receiver to calculate a position within a specified RAIM protection limit (2.0 nautical miles for oceanic and enroute, 1.0 nm for terminal, and 0.3 nm for non-precision approaches). During oceanic, enroute, and terminal phases of flight, RAIM is available nearly 100% of the time.

The RAIM prediction function also indicates whether RAIM is available at a specified date and time. RAIM computations predict satellite coverage within ±15 min of the specified arrival date and time.

Because of the tighter protection limit on approaches, there may be times when RAIM is not available. The system automatically monitors RAIM and warns with an alert message when it is not available. If RAIM is not predicted to be available for the final approach course, the approach does not become active, as indicated by the messages “Approach is not active” and “RAIM not available from FAF to MAP”. If RAIM is not available when crossing the FAF, the missed approach procedure must be flown.

Predicting RAIM availability

- 1) Select the ‘AUX - GPS Status’ Page.
- 2) If necessary, press the **RAIM** Softkey.
- 3) Push the **FMS** Knob. The ‘WAYPOINT’ field is highlighted.
- 4) Turn the small **FMS** Knob to display the Waypoint Information Window.
- 5) Enter the desired waypoint:
 - Use the **FMS** Knob to enter the desired waypoint by identifier, facility, or city name and press the **ENT** Key. Refer to Section 1.6 for instructions on entering alphanumeric data into the system.
 - Or:**
 - a) Use the large **FMS** Knob to scroll to the Most Recent Waypoints List.
 - b) Use the small FMS Knob to highlight the desired waypoint in the list and press the **ENT** Key. The system automatically fills in the identifier, facility, and city fields with the information for the selected waypoint.
 - c) Press the **ENT** Key to accept the waypoint entry.
- 6) Use the **FMS** Knob to enter an arrival time and press the **ENT** Key.
- 7) Use the **FMS** Knob to enter an arrival date and press the **ENT** Key.
- 8) With the cursor highlighting ‘COMPUTE RAIM?’, press the **ENT** Key. Once RAIM availability is computed, one of the following is displayed:
 - ‘COMPUTE RAIM?’—RAIM has not been computed for the current waypoint, time, and date combination
 - ‘COMPUTING AVAILABILITY’—RAIM calculation in progress
 - ‘RAIM AVAILABLE’—RAIM is predicted to be available for the specified waypoint, time, and date
 - ‘RAIM NOT AVAILABLE’—RAIM is predicted to be unavailable for the specified waypoint, time, and date

Predicting RAIM availability at present position

- 1) Select the ‘AUX - GPS Status’ Page.
- 2) If necessary, press the **RAIM** Softkey.
- 3) Push the **FMS** Knob. The ‘WAYPOINT’ field is highlighted.
- 4) Press the **MENU** Key.
- 5) With ‘Set WPT to Present Position’ highlighted, press the **ENT** Key.
- 6) Press the **ENT** Key to accept the waypoint entry.
- 7) Use the **FMS** Knob to enter an arrival time and press the **ENT** Key.
- 8) Use the **FMS** Knob to enter an arrival date and press the **ENT** Key.

- 9) With the cursor highlighting 'COMPUTE RAIM?', press the **ENT** Key. Once RAIM availability is computed, one of the following is displayed:
 - 'COMPUTE RAIM?'—RAIM has not been computed for the current waypoint, time, and date combination
 - 'COMPUTING AVAILABILITY'—RAIM calculation in progress
 - 'RAIM AVAILABLE'—RAIM is predicted to be available for the specified waypoint, time, and date
 - 'RAIM NOT AVAILABLE'—RAIM is predicted to be unavailable for the specified waypoint, time, and date
- SBAS Selection (**SBAS** Softkey pressed) (WAAS, EGNOS, or MSAS capable systems only)

In certain situations, such as when the aircraft is outside or on the fringe of the WAAS, EGNOS, or MSAS coverage area, it may be desirable to disable the reception of the applicable SBAS signal (although it is not recommended). When disabled, the SBAS field in the GPS Status box indicates DISABLED. There may be a small delay for the GPS Status box to be updated upon WAAS, EGNOS, and MSAS enabling/disabling.

Disabling WAAS, EGNOS or MSAS

- 1) Select the 'AUX - GPS Status' Page.
- 2) If necessary, press the **SBAS** Softkey.
- 3) Push the **FMS** Knob, and turn the large FMS Knob to highlight the desired SBAS system.
- 4) Press the **ENT** Key to uncheck the box.
- 5) Push the **FMS** Knob to remove the cursor.

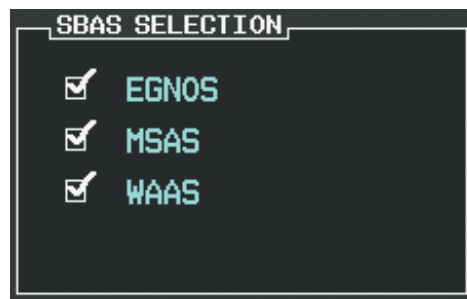

Figure 1-23 Enable/Disable SBAS

- GPS Satellite Signal Strengths

The 'AUX - GPS Status' Page can be helpful in troubleshooting weak (or missing) signal levels due to poor satellite coverage or installation problems. As the GPS receiver locks onto satellites, a signal strength bar is displayed for each satellite in view, with the appropriate satellite identification number below each bar. The progress of satellite acquisition is shown in three stages, as indicated by signal bar appearance:

 - No bar—Receiver is looking for the indicated satellite
 - Hollow bar—Receiver has found the satellite and is collecting data
 - Cyan bar—Receiver has collected the necessary data and the satellite signal can be used
 - Green bar—Satellite is being used for the GPS solution
 - Checkered bar—Receiver has excluded the satellite (Fault Detection and Exclusion)
 - "D" indication—Denotes the satellite is being used as part of the differential computations

Each satellite has a 30-second data transmission that must be collected (signal strength bar is hollow) before the satellite may be used for navigation (signal strength bar becomes solid).

1.5 ACCESSING SYSTEM FUNCTIONALITY

MENUS

The system has a dedicated **MENU** Key that when pressed displays a context-sensitive list of options. This options list allows the user to access additional features or make settings changes which specifically relate to the currently displayed window/page. There is no all-encompassing menu. Some menus provide access to additional submenus that are used to view, edit, select, and review options. Menus display 'No Options' when there are no additional features or settings for the window/page selected.

Navigating a menu:

- 1) Press the **MENU** Key to display the menu.
- 2) Turn the **FMS** Knob to scroll through a list of available options (a scroll bar always appears to the right of the window/box when the option list is longer than the window/box).
- 3) Press the **ENT** Key to select the desired option.
- 4) Press the **CLR** Key or **FMS** Knob to remove the menu and cancel the operation.

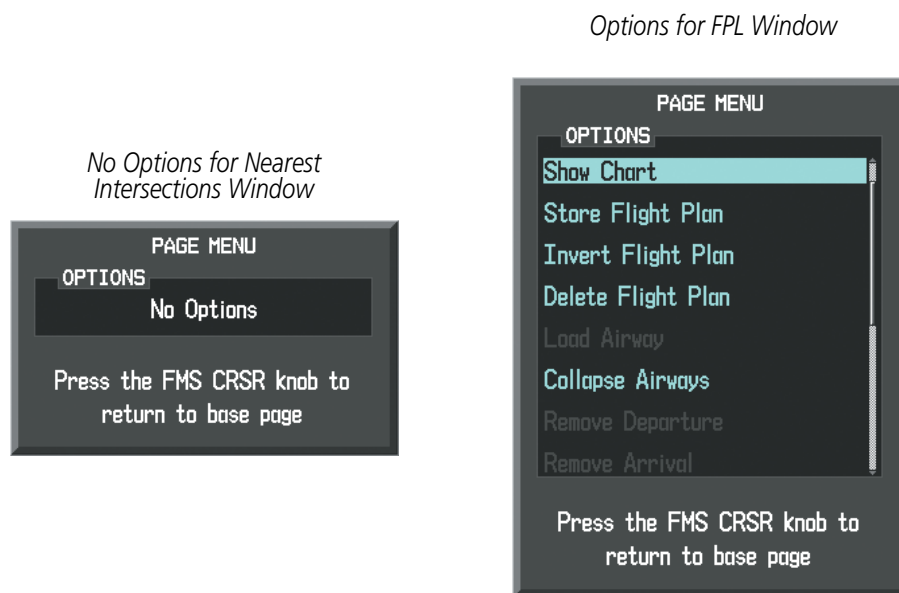

Figure 1-24 Page Menu Examples

PAGE GROUPS



NOTE: Refer to other supporting sections in this Pilot's Guide for details on specific pages.

Information on the MFD is presented on pages which are grouped according to function. The page group and active page title are displayed in the upper center of the screen, below the Navigation Status Box. In the bottom right corner of the screen, the page group tabs are displayed along the bottom. The titles of pages available in the group are displayed in a list above the page groups. The current page group and current page within the group are shown in cyan. For some of these pages (Airport/Procedures/Weather Information, XM, Procedure Loading), the active title of the page changes while the page name in the list remains the same.

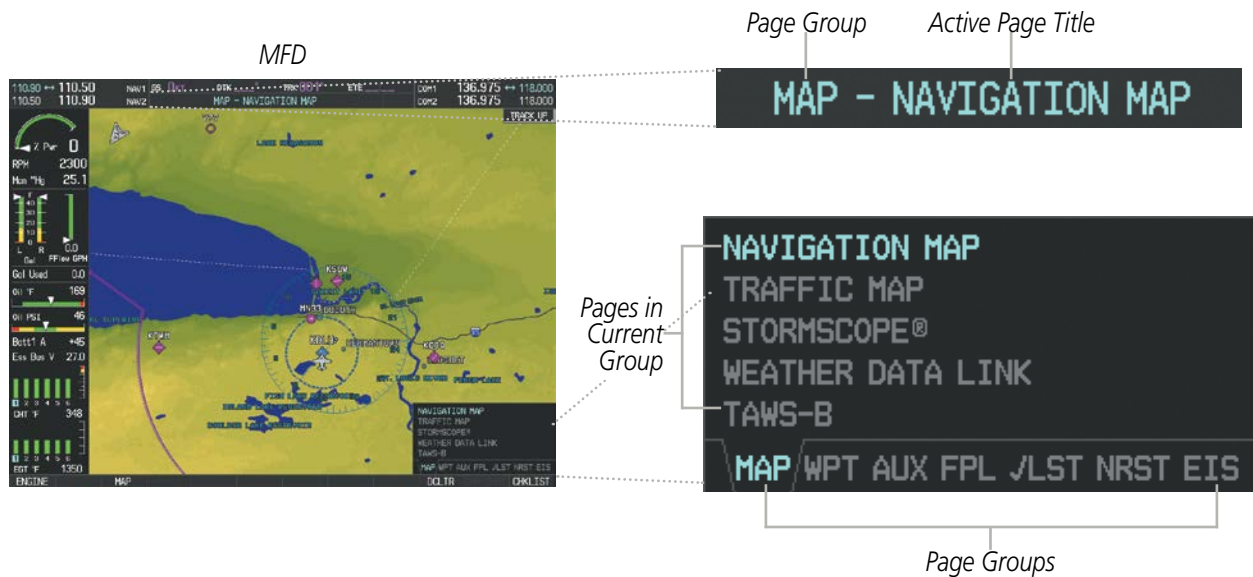

Figure 1-25 Page Title and Page Groups

The main page groups are navigated using the **FMS** Knob; specific pages within each group can vary depending on the configuration of optional equipment.

Selecting a page using the FMS Knob:

- 1) Turn the large **FMS** Knob to display the list of page groups; continue turning the large **FMS** Knob until the desired page group is selected
- 2) Turn the small **FMS** Knob to display the desired page within a specific page group.

There are also several pages (Airport/Procedures/Weather Information and XM pages) which are selected first from within a main page group with the **FMS** Knob, then with the appropriate softkey at the bottom of the page (or from the page menu). In this case, the page remains set to the selected page until a different page softkey is selected, even if a different page group is selected.

Map Pages (MAP)

- Navigation Map
- Traffic Map
- Stormscope (optional)
- Weather Data Link (services optional)
- Terrain Proximity/Terrain-SVS (optional)/ TAWS-B (optional)

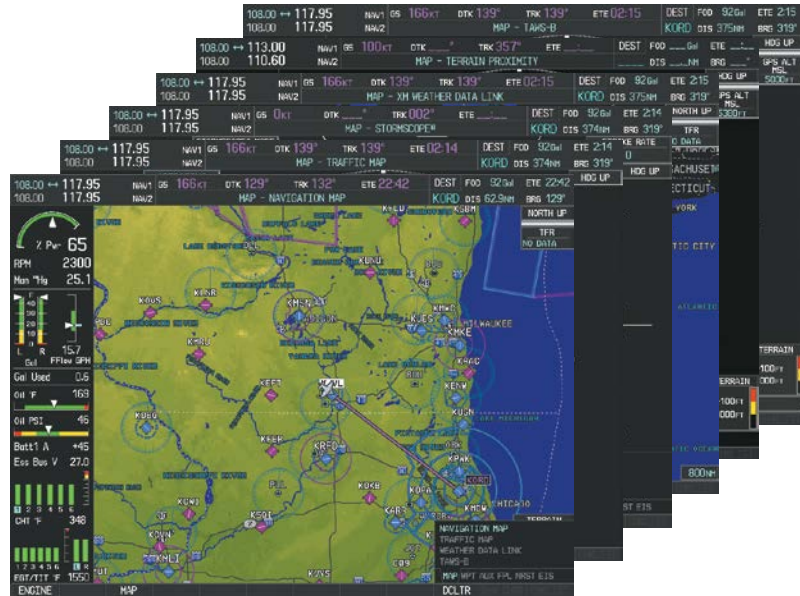
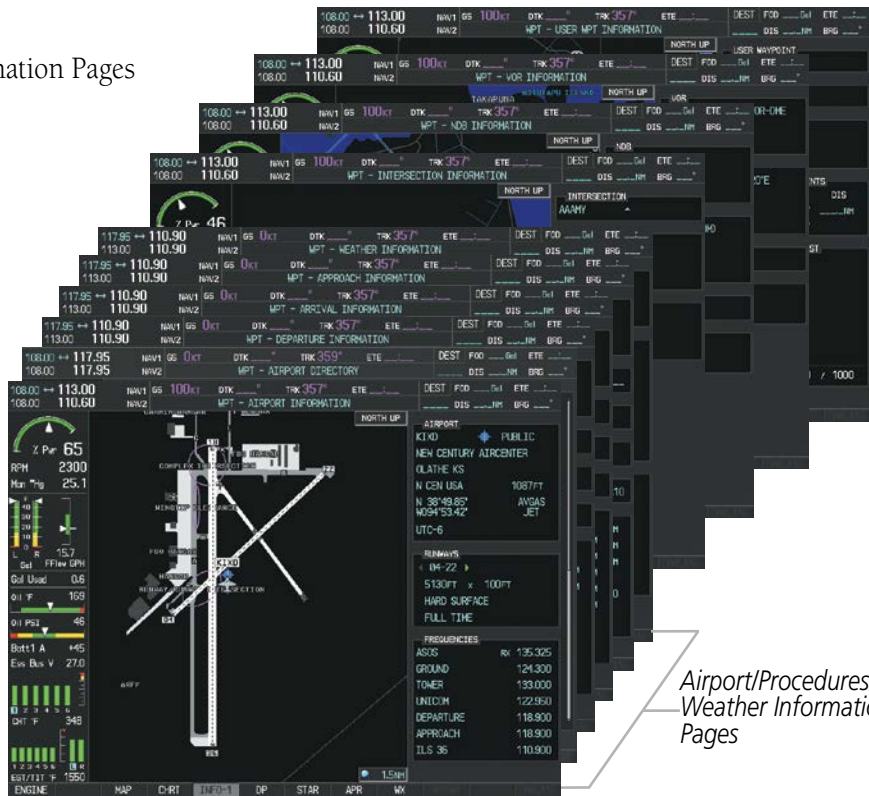

Figure 1-26 Map Pages

Waypoint Pages (WPT)

Airport/Procedures/Weather Information Pages

- Airport Information (**INFO-1** Softkey)
- Airport Directory (**INFO-2** Softkey)
- Departure Information (**DP** Softkey)
- Arrival Information (**STAR** Softkey)
- Approach Information (**APR** Softkey)
- Weather Information (optional) (**WX** Softkey)
- Intersection Information
- NDB Information
- VOR Information
- User Waypoint Information



Airport/Procedures/
Weather Information
Pages

Figure 1-27 Waypoint Pages

Auxiliary Pages (AUX)

- Trip Planning
- Utility
- GPS Status
- System Setup Page(s)
- SiriusXM Pages (optional)
 - XM Radio (**RADIO** Softkey)
 - XM Information (**INFO** Softkey)
- Satellite Phone Pages (optional)
 - Telephone (**TEL** Softkey)
 - Text Messaging (**SMS** Softkey)
- Data Link Pages (optional)
 - Wi-Fi Setup (**WI-FI** Softkey)
- Connex Page (optional)
- System Status
- Video (optional)
- Bluetooth Management (optional)

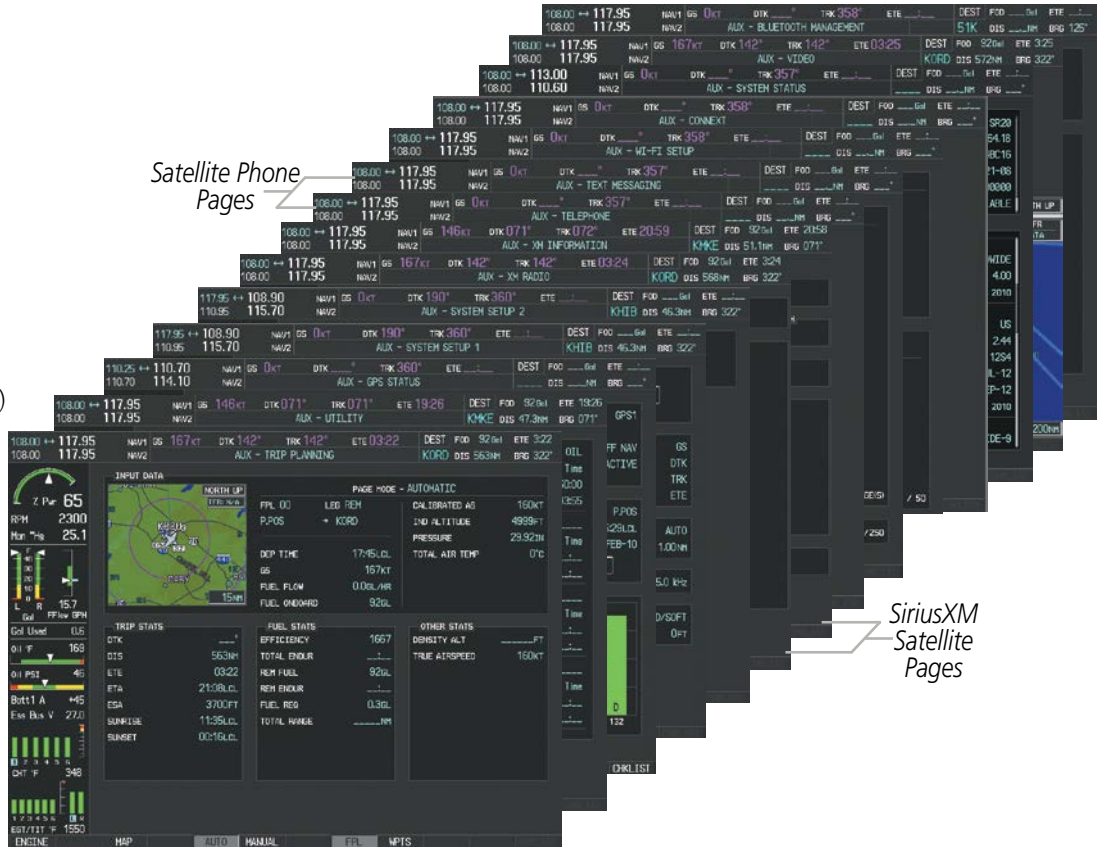

Figure 1-28 Auxiliary Pages

Nearest Pages (NRST)

- Nearest Airports
- Nearest Intersections
- Nearest NDB
- Nearest VOR
- Nearest User Waypoints
- Nearest Frequencies
- Nearest Airspaces

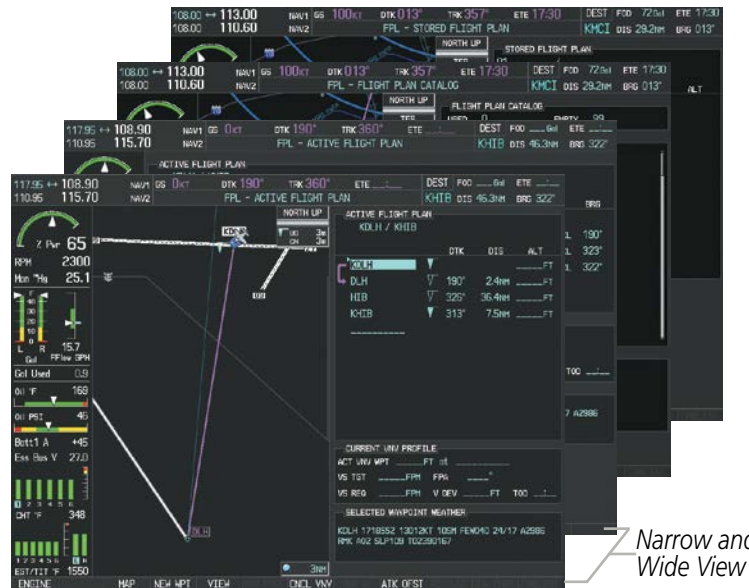

Figure 1-29 Nearest Pages

In addition to the main page groups accessed exclusively using the **FMS** Knobs, the 'FPL' Pages can also be accessed using the **FPL** Key on the PFD/MFD Control Unit. Main pages within this group are then selected by pressing the **FMS** Key and turning the **FMS** Knobs. In some instances, softkeys may be used to access the 'PROC' Pages.

Flight Plan Pages (FPL)

- Active Flight Plan
 - Wide View, Narrow View (**VIEW** Softkey)
- Flight Plan Catalog
- or
- Stored Flight Plan (**NEW** Softkey)



Narrow and Wide View

Figure 1-30 Flight Plan Pages

The 'PROC' Pages may be accessed at any time on the PFD/MFD Control Unit by pressing the **PROC** Key. A menu is initialized, and when a departure, approach, or arrival is selected, the appropriate Page is opened. Turning the **FMS** Knob does not scroll through the Procedure pages.

**Procedure Pages
(PROC)**

- Departure Loading
- Arrival Loading
- Approach Loading



Figure 1-31 Procedure Pages

SYSTEM SETTINGS

System settings are managed from the 'AUX - System Setup' Page. The following settings can be changed:

- Time Format and Offset
- Display Units (see Flight Instruments Section)
- Baro Transition alert (see Flight Instruments Section)
- Airspace alerts (see Flight Management Section)
- Audio Alert Voice
- Page Navigation Settings
- MFD Navigation Data Bar Fields (see Flight Management Section)
- CDI scaling for GPS navigation source (see Flight Instruments Section)
- COM channel spacing (see Audio Panel and CNS Section)
- Criteria for displaying nearest airports (see Flight Management Section)
- Electronic Stability & Protection enable/disable (see Additional Features Section) (*optional*)

Restoring system setup defaults:

- 1) Use the **FMS** Knob to select the 'AUX - System Setup' Page.
 - 2) Press the **DFLTS** Softkey.
- Or:**
- a) Press the **MENU** Key.
 - b) Highlight 'Restore Defaults' and press the **ENT** Key.

- SYSTEM OVERVIEW
- FLIGHT INSTRUMENTS
- EIS
- AUDIO PANEL & CNS
- FLIGHT MANAGEMENT
- HAZARD AVOIDANCE
- AFCS
- ADDITIONAL FEATURES
- APPENDICES
- INDEX

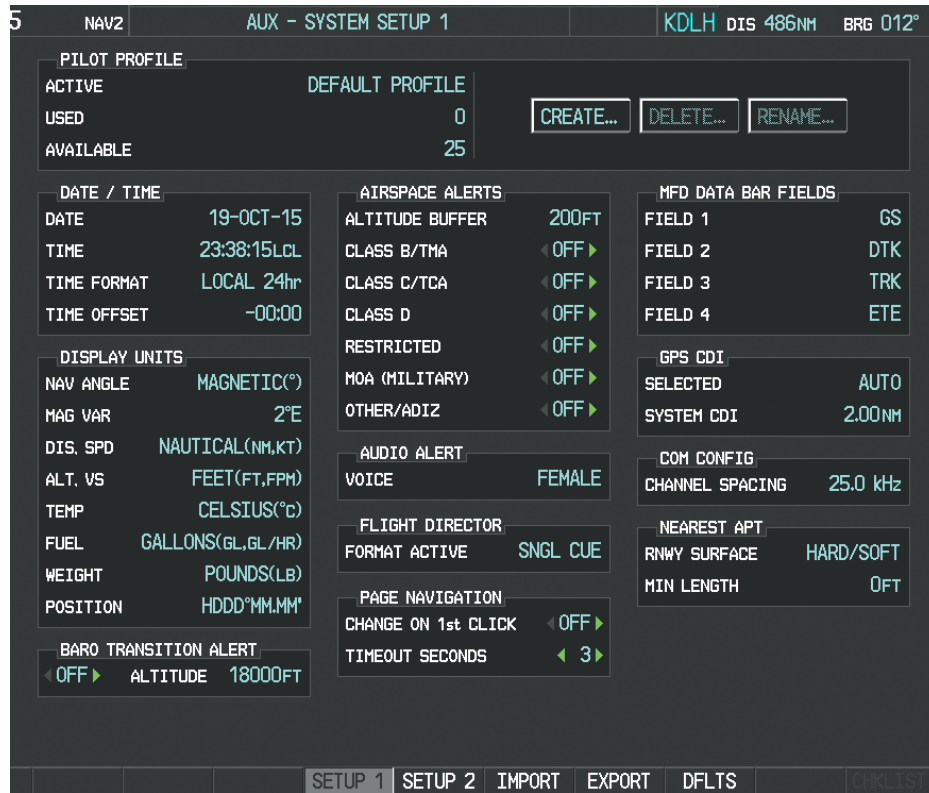

Figure 1-32 'AUX - System Setup' Page

DATE/TIME

The system obtains the current Coordinated Universal Time (UTC) date and time directly from the GPS satellite signals (shown on the 'AUX - GPS Status' Page, Figure 1-22). System time (displayed in the lower right corner of the PFD) can be displayed in three formats: local 12-hr, local 24-hr, or UTC. Local time is set by adding/subtracting an offset (hours:minutes) to/from UTC.



Figure 1-33 System Time (Local 24-hr Format)

Configuring the system time:

- 1) Select the 'AUX - System Setup' Page using the **FMS** Knob.
- 2) Push the **FMS** Knob to activate the cursor.
- 3) Turn the large **FMS** Knob to highlight the 'Time Format' field.
- 4) Turn the small **FMS** Knob to select the desired format and press the **ENT** Key to confirm selection. The 'Time Offset' field is highlighted.
- 5) Use the **FMS** Knob to enter the desired time offset (\pm HH:MM) and press the **ENT** Key to confirm selection.



Figure 1-34 Date/Time Settings ('AUX - System Setup 1' Page)

DISPLAY UNITS

Units in which various quantities are displayed on the system screens are listed on the 'AUX - System Setup 1' Page. The Navigation Angle reference can be set from here (refer to the Flight Instruments Section).

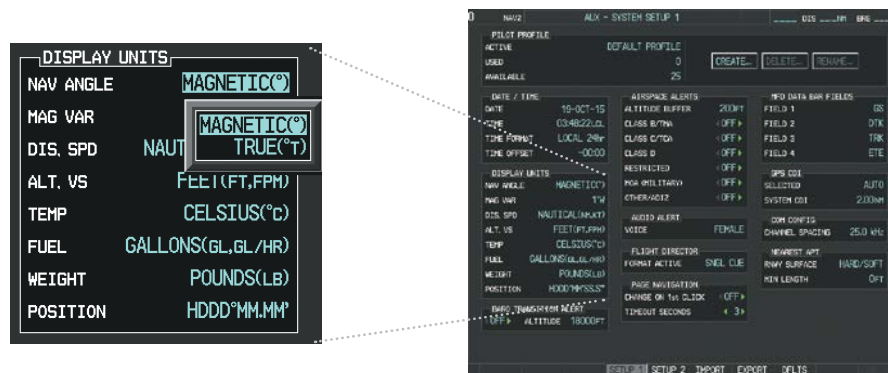

Figure 1-35 Display Unit Settings ('AUX - System Setup 1' Page)

SYSTEM OVERVIEW

FLIGHT INSTRUMENTS

EIS

AUDIO PANEL & CNS

FLIGHT MANAGEMENT

HAZARD AVOIDANCE

AFCS

ADDITIONAL FEATURES

APPENDICES

INDEX

Category	Settings	Affected Quantities	Exceptions
Navigation Angle	Magnetic* True	Heading Course Bearing Track Desired Track Wind direction ('AUX - Trip Planning' Page)	N/A
Distance and Speed	Metric Nautical*	Crosstrack error (HSI) Bearing distances (information windows) DME distance (information window) Flight plan distances Map ranges DIS, GS, TAS, XTK fields (Navigation Status Box) All distances on MFD Altitude buffer distance ('System Setup' Page) All speeds on MFD	Airspeed Indicator True Airspeed (PFD) Ground Speed (PFD) Wind speed vector Map range ('Traffic', 'Terrain Proximity'/'TAWS-B' Page) CDI scaling (System Setup) Fuel range calculation (EIS)
Altitude and Vertical Speed	Feet* Meters	All altitudes on MFD All elevations on MFD	Altimeter Vertical Speed Indicator VNV altitudes (Active Flight Plan)
Temperature	Celsius* Fahrenheit	All temperatures on PFD Total Air Temperature ('AUX - Trip Planning' Page)	Engine Indication System (EIS)
Fuel and Fuel Flow	Gallons* Liters	Fuel parameters ('AUX - Trip Planning' Page)	Engine Indication System (EIS)
Weight	Kilograms Pounds*	N/A	N/A
Position	HDDD°MM.MM'* HDDD°MM'SS.S"	All positions	N/A

* Default

Table 1-1 Display Units Settings ('AUX - System Setup' Page)

PILOT PROFILES

System settings may be saved under a pilot profile. When the system is powered on, the last selected pilot profile is shown on the MFD Power-up Page (Figure 1-15). The system can store up to 25 profiles; the currently active profile, the number of profiles used, and the number of profiles available are shown at the top of the ‘AUX - System Setup’ Page in the box labeled ‘Pilot Profile’. From here, pilot profiles may be created, selected, renamed, or deleted. Pilot profiles may also be exported from the system to an SD card, or imported from an SD card into the system.



Figure 1-36 Pilot Profiles ('AUX - System Setup' Page)

Creating a profile:

- 1) Use the **FMS** Knob to select the ‘AUX - System Setup’ Page.
- 2) Push the **FMS** Knob momentarily to activate the flashing cursor.
- 3) Turn the large **FMS** Knob to highlight ‘CREATE’ in the Pilot Profile Box.
- 4) Press the **ENT** Key. A ‘Create Profile’ window is displayed.
- 5) Use the **FMS** Knob to enter a profile name up to 16 characters long and press the **ENT** Key. Pilot profile names cannot begin with a blank as the first letter.
- 6) In the next field, use the small **FMS** Knob to select the desired settings upon which to base the new profile. Profiles can be created based on Garmin factory defaults, default profile settings (initially based on Garmin factory defaults unless edited by the pilot), or current system settings.
- 7) Press the **ENT** Key.
- 8) With ‘CREATE’ highlighted, press the **ENT** Key to create the profile

Or:

Use the large **FMS** Knob to select ‘CREATE and ACTIVATE’ and press the **ENT** Key to activate the new profile.

- 9) To cancel the process, select ‘CANCEL’ with the large FMS Knob and press the **ENT** Key.

Selecting an active profile:

- 1) Use the **FMS** Knob to select the 'AUX - System Setup' Page.
- 2) Push the **FMS** Knob momentarily to activate the flashing cursor.
- 3) Turn the large **FMS** Knob to highlight the active profile field in the Pilot Profile Box.
- 4) Turn the small **FMS** Knob to display the pilot profile list and highlight the desired profile.
- 5) Press the **ENT** Key. The system loads and displays the system settings for the selected profile.

Renaming a profile:

- 1) Use the **FMS** Knob to select the 'AUX - System Setup' Page.
- 2) Push the **FMS** Knob momentarily to activate the flashing cursor.
- 3) Turn the large **FMS** Knob to highlight 'RENAME' in the Pilot Profile Box.
- 4) Press the **ENT** Key.
- 5) In the 'Rename Profile' window, turn the **FMS** Knob to select the profile to rename.
- 6) Press the **ENT** Key.
- 7) Use the **FMS** Knob to enter a new profile name up to 16 characters long and press the **ENT** Key.
- 8) With 'RENAME' highlighted, press the **ENT** Key.
- 9) To cancel the process, use the large **FMS** Knob to select 'CANCEL' and press the **ENT** Key.

Deleting a profile:

- 1) Use the **FMS** Knob to select the 'AUX - System Setup' Page.
- 2) Push the **FMS** Knob momentarily to activate the flashing cursor.
- 3) Turn the large **FMS** Knob to highlight 'DELETE' in the Pilot Profile Box.
- 4) Press the **ENT** Key.
- 5) In the 'Delete Profile' window, turn the **FMS** Knob to select the profile to delete.
- 6) Press the **ENT** Key.
- 7) With 'DELETE' highlighted, press the **ENT** Key.
- 8) To cancel the process, use the large **FMS** Knob to select 'CANCEL' and press the **ENT** Key.

If an SD card is inserted into the top slot of the MFD, pilot profiles may be imported from the SD card into the system, or exported from the system to the SD card.

Because system settings may vary from one airframe to another, always verify system settings from an imported profile are consistent with the desired settings.

Importing a profile from an SD card:

- 1) Insert an SD card containing the pilot profile(s) into the top card slot on the MFD.
- 2) Turn the **FMS** Knob to select the 'AUX - System Setup' Page.
- 3) Select the **IMPORT** Softkey.

Or:

- a) Press the **MENU** Key.
- b) Turn the **FMS** Knob to highlight 'Import Pilot Profile' and press the **ENT** Key.
- 4) The system displays the Pilot Profile Importing window with 'IMPORT' highlighted. To change the selected profile to be imported from the SD card (shown as 'SELECT FILE'), turn the large FMS Knob to highlight the profile file name, then turn the small **FMS** Knob to highlight a profile from the list, and press the **ENT** Key.
- 5) If desired, the profile name to be used after profile has been imported can be changed by turning the **FMS** Knob to highlight the 'PROFILE NAME' field, then use the large and small **FMS** Knobs to enter the name, and press the **ENT** Key. Imported profile names cannot begin with a blank space or be named 'DEFAULT', 'GARMIN DEFAULTS' or 'DEFAULT SETTINGS'.
- 6) With 'IMPORT' highlighted, press the **ENT** Key.
- 7) If the imported profile name is the same as an existing profile on the system, the system displays an 'Overwrite existing file? OK or CANCEL' prompt. Press the **ENT** Key to replace profile on the system with the profile imported from the SD card, or turn the **FMS** Knob to highlight 'CANCEL' and press the **ENT** Key to return to the Pilot Profile Importing window.
- 8) If successful, the system displays 'Pilot profile import succeeded.' in the IMPORT RESULTS window below. With 'OK' highlighted, press the **ENT** or **CLR** Keys or push the **FMS** Knob to return to the 'AUX - System Setup' Page. The imported profile becomes the active profile.

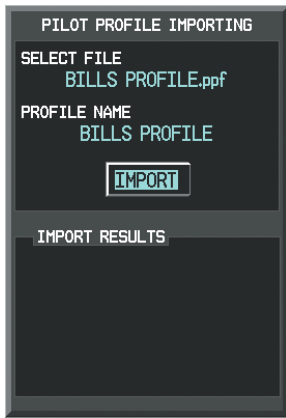

Pilot Profile Importing and Import Results Window

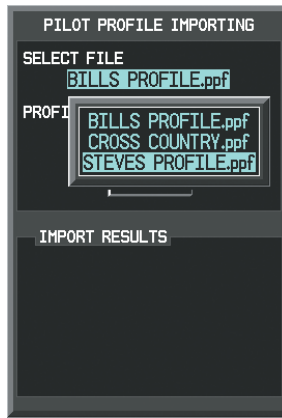

Pilot Profiles Available for Import from SD Card ('STEVE'S PROFILE' Selected)



Import Successful

Figure 1-37 Pilot Profile Import ('AUX - System Setup' Page)

Exporting a profile to an SD card:

- 1) Insert the SD card for storing the Pilot Profile into the top card slot on the MFD.
- 2) Turn the **FMS** Knob to select the 'AUX - System Setup' Page.
- 3) If necessary, activate the desired pilot profile to export. Only the currently active Pilot Profile can be exported.
- 4) Select the **EXPORT** Softkey. The system displays the Pilot Profile Exporting window.

Or:

 - a) Press the **MENU** Key.
 - b) Turn the **FMS** Knob to highlight 'Export Pilot Profile' and press the **ENT** Key.
- 5) To export the pilot profile using the current supplied name, press the **ENT** Key with 'EXPORT' highlighted. To change the profile file name turn the large **FMS** Knob to highlight the 'SELECT FILE' field, then enter the new name with the large and small FMS Knobs, then press the **ENT** Key. Then press the **ENT** Key with 'EXPORT' highlighted.
- 6) If the profile name to be exported is the same as an existing profile file name on the SD card, the system displays an 'Overwrite existing file? OK or CANCEL' prompt. Press the **ENT** Key to replace the profile on the SD card with the profile to be exported, or turn the FMS Knob to highlight 'CANCEL' and press the **ENT** Key to return to the Pilot Profile Exporting window without exporting the profile.
- 7) If successful, the EXPORT RESULTS window displays 'Pilot profile export succeeded.' With 'OK' highlighted, press the **ENT** or **CLR** Keys, or push the **FMS** Knob to return to the 'AUX - System Setup' Page.



Pilot Profile Exporting Window, Enter a Name to Use for Exported Profile

Export Successful

Figure 1-38 Pilot Profile Export on the 'AUX - System Setup' Page

PAGE NAVIGATION

The large **FMS** Knob displays the Page Group Tabs and navigates through the tabs. The small **FMS** Knob navigates through the pages within a specific group. The number of clicks it takes to display the Page Group Tabs and change to the next tab can be controlled from the Page Navigation box on the 'AUX - System Setup' Page.

OFF – Displays the Page Group Tabs with one click of the large **FMS** Knob.

ON – Displays the Page Group Tabs and navigates to the next tab with one click of the large **FMS** Knob.

The pilot can select, from the 'AUX - System Setup' Page, the amount of time the Page Group Tabs are displayed (in the lower right corner of the MFD). The timeout can range from two to ten seconds.

Selecting page navigation settings:

- 1) Use the **FMS** Knob to select the 'AUX - System Setup' Page.
- 2) Push the **FMS** Knob momentarily to activate the flashing cursor.
- 3) Turn the large **FMS** Knob to highlight the 'Change On 1st Click' field in the Page Navigation Box.
- 4) Turn the small **FMS** Knob to select 'OFF' or 'ON'.
- 5) Turn the large **FMS** Knob to highlight the 'Timeout Seconds' field in the Page navigation Box.
- 6) Turn the small **FMS** Knob to select the desired number of seconds
- 7) Push the **FMS** Knob momentarily to remove the flashing cursor.

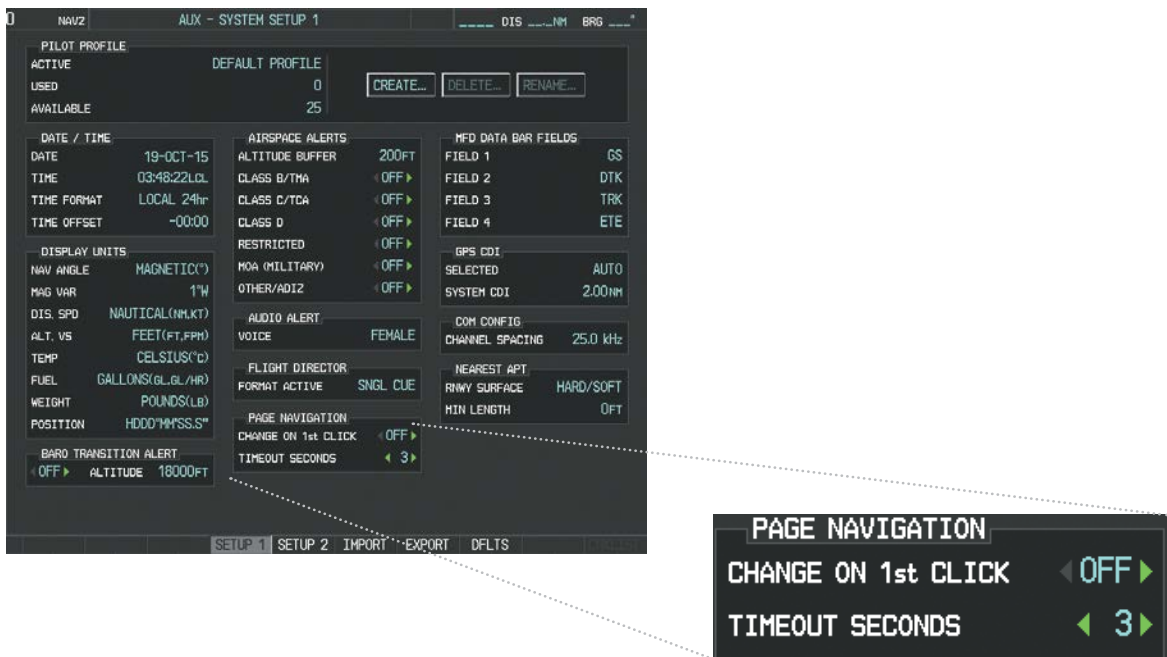

Figure 1-39 Page Navigation Settings ('AUX - System Setup' Page)

TIMERS

The system timers available include:

- Stopwatch-like generic timers (available from the PFD Timer/References Window and on the MFD 'AUX - Utility' Page)
- Total-time-in-flight timer (MFD 'AUX - Utility' Page)
- Time since departure (MFD 'AUX - Utility' Page)

The generic timer can be set to count up or down from a specified time (HH:MM:SS). When the countdown on the timer reaches zero the digits begin to count up from zero. If the timer is reset before reaching zero on a countdown, the digits are reset to the initial value. If the timer is counting up when reset, the digits are zeroed.

Setting the generic timer (PFD):

- 1) Press the **TMR/REF** Softkey.
- 2) Turn the large **FMS** Knob to select the timer field (hh/mm/ss).
- 3) Use the **FMS** Knob to enter the desired time and press the **ENT** Key.
- 4) With the UP/DN field highlighted, turn the small **FMS** Knob to select the timer counting direction.
- 5) Press the **ENT** Key.
- 6) With 'START?' highlighted, press the **ENT** Key to start the timer. The field changes to 'STOP?'.
- 7) To stop the timer, press the **ENT** Key with 'STOP?' highlighted. The field changes to 'RESET?'.
- 8) To reset the timer, press the **ENT** Key with 'RESET?' highlighted. The field changes back to 'START?' and the digits are reset.
- 9) To remove the window, press the **CLR** Key or the **TMR/REF** Softkey.



Figure 1-40 Generic Timer (Timer/References Window)

The flight timer can be set to count up from zero starting at system power-up or from the time that the aircraft lifts off; the timer can also be reset to zero at any time.

Setting the generic timer (MFD 'AUX - Utility' Page):

- 1) Use the **FMS** Knob to select the 'AUX - Utility' Page.
- 2) Push the **FMS** Knob momentarily to activate the flashing cursor.

- 3) Turn the small **FMS** Knob to select the timer counting direction (UP/DN) and press the **ENT** Key.
- 4) If a specific starting time is desired:
 - a) Use the large **FMS** Knob to highlight the HH:MM:SS field.
 - b) Use the **FMS** Knob to enter the desired time and press the **ENT** Key.
- 5) Turn the large **FMS** Knob to highlight 'START?' and press the **ENT** Key to start the timer. The field changes to 'STOP?'.
- 6) To stop the timer, press the **ENT** Key with 'STOP?' highlighted. The field changes to 'RESET?'.
- 7) To reset the timer, press the **ENT** Key with 'RESET?' highlighted. The field changes back to 'START?' and the digits are reset.

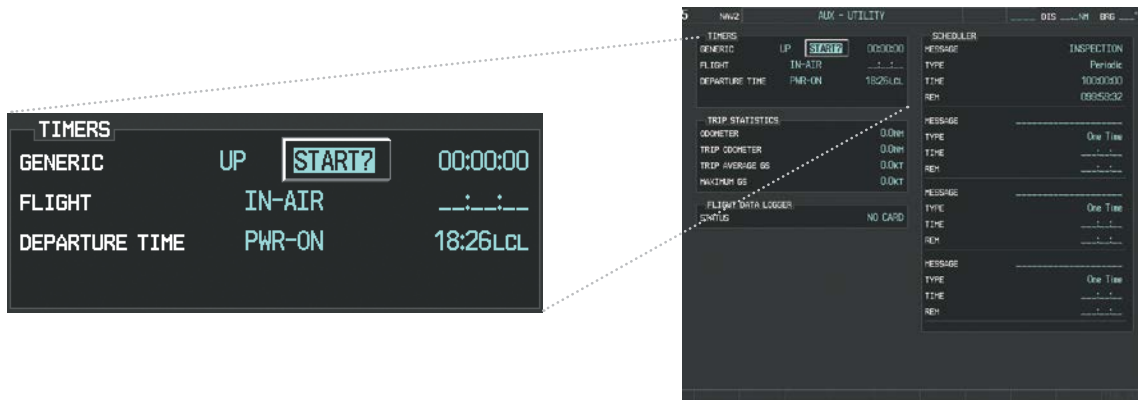

Figure 1-41 Timers ('AUX - Utility' Page)

Setting the flight timer starting criterion:

- 1) Use the **FMS** Knob to select the 'AUX - Utility' Page.
- 2) Push the **FMS** Knob momentarily to activate the flashing cursor.
- 3) Turn the large **FMS** Knob to highlight the field next to the flight timer.
- 4) Turn the small **FMS** Knob to select the starting criterion (PWR-ON or IN-AIR) and press the **ENT** Key.

Resetting the flight timer:

- 1) Use the **FMS** Knob to select the 'AUX - Utility' Page.
- 2) Press the **MENU** Key.
- 3) With 'Reset Flight Timer' highlighted, press the **ENT** Key.

The system records the time at which departure occurs, depending on whether the pilot prefers the time to be recorded from system power-up or from aircraft lift off. The displayed departure time can also be reset to display the current time at the point of reset. The format in which the time is displayed is controlled from the 'AUX - System Setup' Page.

SYSTEM OVERVIEW

FLIGHT INSTRUMENTS

EIS

AUDIO PANEL & CNS

FLIGHT MANAGEMENT

HAZARD AVOIDANCE

AFCS

ADDITIONAL FEATURES

APPENDICES

INDEX

Setting the departure timer starting criterion:

- 1) Use the **FMS** Knob to select the 'AUX - Utility' Page.
- 2) Push the **FMS** Knob momentarily to activate the flashing cursor.
- 3) Turn the large **FMS** Knob to highlight the field next to the departure time.
- 4) Turn the small **FMS** Knob to select the starting criterion (PWR-ON or IN-AIR) and press the **ENT** Key.

Resetting the departure time:

- 1) Use the **FMS** Knob to select the 'AUX - Utility' Page.
- 2) Press the **MENU** Key.
- 3) Turn the **FMS** Knob to highlight 'Reset Departure Time' and press the **ENT** Key.

GPS POSITION

The Timer/References Window on the PFD shows the current GPS position at the bottom of the window using the selected display format (HHDD°MM.MM' or HDDD°MM'SS.S").

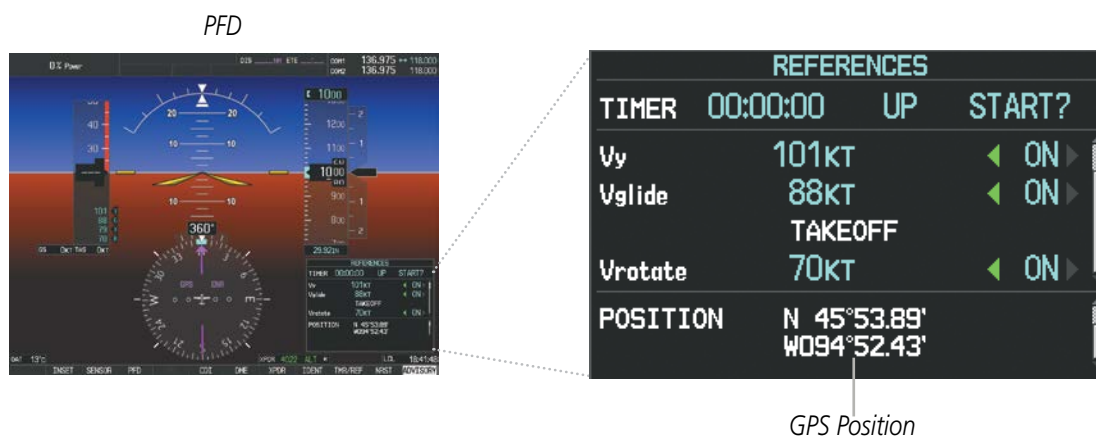

Figure 1-42 GPS Position (Timer/References Window)

Viewing the GPS Position in the Timer/References Window:

- 1) Press the **TMR/REF** Softkey.
- 2) Turn the large **FMS** Knob until the 'POSITION' field appears.
- 3) To remove the Timer/References Window, press the **TMR/REF** Softkey or press the **CLR** Key.

Changing the GPS Position display format:

- 1) On the MFD, turn the **FMS** Knob to select the 'AUX - System Setup 1' Page.
- 2) Push the **FMS** Knob momentarily to activate the flashing cursor.
- 3) Turn the large **FMS** Knob to highlight the 'POSITION' field in the Display Units Window.
- 4) Turn the small **FMS** Knob to highlight the desired selection (HHDD°MM.MM' or HDDD°MM'SS.S") and press the **ENT** Key.

1.6 DISPLAY BACKLIGHTING

The dimming bus is the primary source for backlighting adjustments of the PFD and MFD displays, bezel, Audio Panel keys, AFCS Control Unit keys, and PFD/MFD Control Unit keys. The automatic backlighting adjustment for the AFCS Control Unit annunciators and PFD/MFD Control Unit annunciators uses photocell technology to automatically adjust for ambient lighting conditions. Photocell calibration curves are pre-configured to optimize display appearance through a broad range of cockpit lighting conditions. Manual backlighting adjustment can be accomplished using the existing instrument panel dimming bus or the following procedures. In normal operating mode, backlighting can only be adjusted from the PFD. In Reversionary Mode, it can be adjusted from the remaining display.

Adjusting display backlighting:

- 1) Press the PFD **MENU** Key to display the PFD Setup Menu. 'AUTO' is now highlighted next to 'PFD DSPL'.
- 2) Turn the small **FMS** Knob to select 'MANUAL'.
- 3) Press the **ENT** Key. The intensity value is now highlighted.
- 4) Use the **FMS** Knob to enter the desired backlighting then press the **ENT** Key.
- 5) Turn the large **FMS** Knob to highlight 'AUTO' next to 'MFD DSPL' and repeat steps 2-4.
- 6) To remove the menu, press the **CLR** or **MENU** Key.

Adjusting key backlighting:

- 1) Press the PFD **MENU** Key to display the PFD Setup Menu. 'AUTO' is now highlighted next to 'PFD DSPL'.
- 2) Turn the large **FMS** Knob to highlight 'PFD DSPL'.
- 3) Turn the small **FMS** Knob in the direction of the green arrowhead to display 'PFD KEY'.
- 4) Turn the large **FMS** Knob to highlight 'AUTO'.
- 5) Turn the small **FMS** Knob to select 'MANUAL'.
- 6) Press the **ENT** Key. The intensity value is now highlighted.
- 7) Use the **FMS** Knob to enter the desired backlighting and press the **ENT** Key.
- 8) Turn the large **FMS** Knob to highlight 'MFD DSPL'.
- 9) Turn the small **FMS** Knob in the direction of the green arrowhead to display 'MFD KEY' and repeat steps 4-7.
- 10) To remove the menu, press the **CLR** or **MENU** Key.

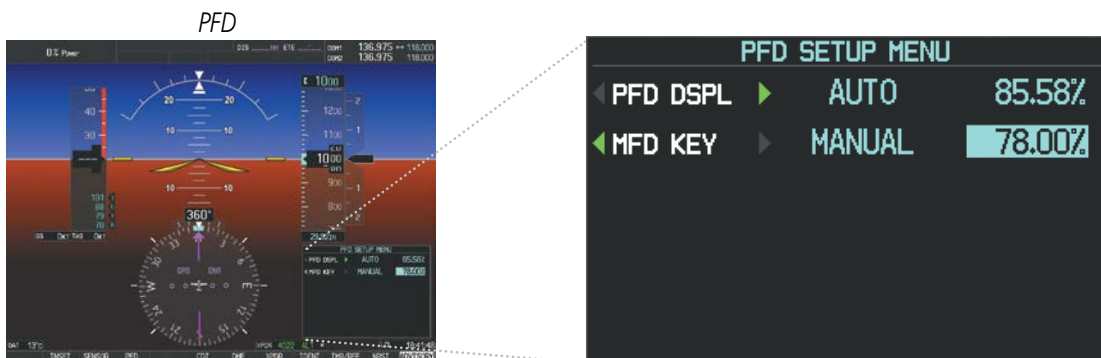

Figure 1-43 PFD Setup Menu

1.7 SECURE DIGITAL CARDS



NOTE: Refer to the Appendices for instructions on updating the aviation databases.



NOTE: Ensure that the system is powered off before inserting the SD card.

The PFD and MFD data card slots use Secure Digital (SD) cards and are located on the top right portion of the display bezels. Each display bezel is equipped with two SD card slots. The system uses SD cards to store databases (such as terrain or charts), in addition to loading software updates, and to allow for the import or export of data including flight plans, pilot profiles, and flight data logs.

Install an SD card:

Insert the SD card in the SD card slot, pushing the card in until the spring latch engages. The front of the card should remain flush with the face of the display bezel.

Remove an SD card:

Gently press on the SD card to release the spring latch and eject the card.

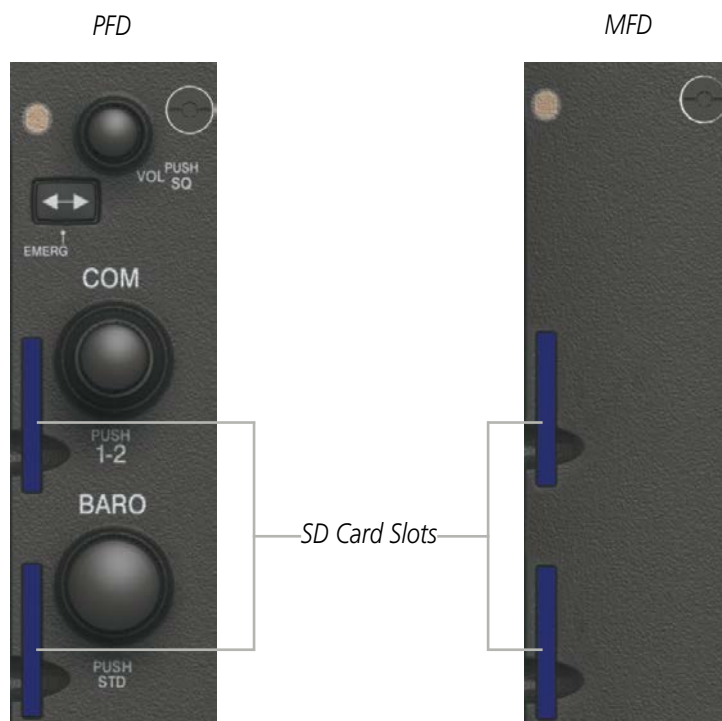

Figure 1-44 Display Bezel SD Card Slots

SECTION 2 FLIGHT INSTRUMENTS



WARNING: *If the airspeed, attitude, altitude, or heading indications become unusable, refer to the backup instruments.*



NOTE: *The Automatic Flight Control System (AFCS) provides additional readouts and bugs on selected flight instruments. Refer to the AFCS Section for details on these bugs and readouts, as they appear on the display during certain AFCS flight director modes.*

The Primary Flight Display (PFD) features a large horizon, airspeed, attitude, altitude, vertical speed, and course deviation information. In addition to the flight instruments, navigation, communication, terrain, traffic, and weather information are also presented on the PFD and explained in other sections of this Pilot's Guide.

The following flight instruments and supplemental flight data are displayed on the PFD:

- Airspeed Indicator, showing
 - Indicated Airspeed
 - Ground Speed
 - True Airspeed
 - Reference bugs
 - Airspeed awareness ranges
- Attitude Indicator with slip/skid indication
- Altimeter, showing
 - Barometric setting
 - Selected Altitude
- Vertical Deviation, Glideslope, and Glidepath Indicators
- Vertical Speed Indicator (VSI)
- Vertical Navigation indications
- Outside Air Temperature (OAT)
- DME Tuning Window
- Wind data
- System time
- Inset Map
- Horizontal Situation Indicator, showing
 - Turn Rate Indicator
 - Bearing pointers and information windows
 - DME Information Window
 - Navigation source
 - Course Deviation Indicator (CDI)

The PFD also displays various alerts and annunciations.

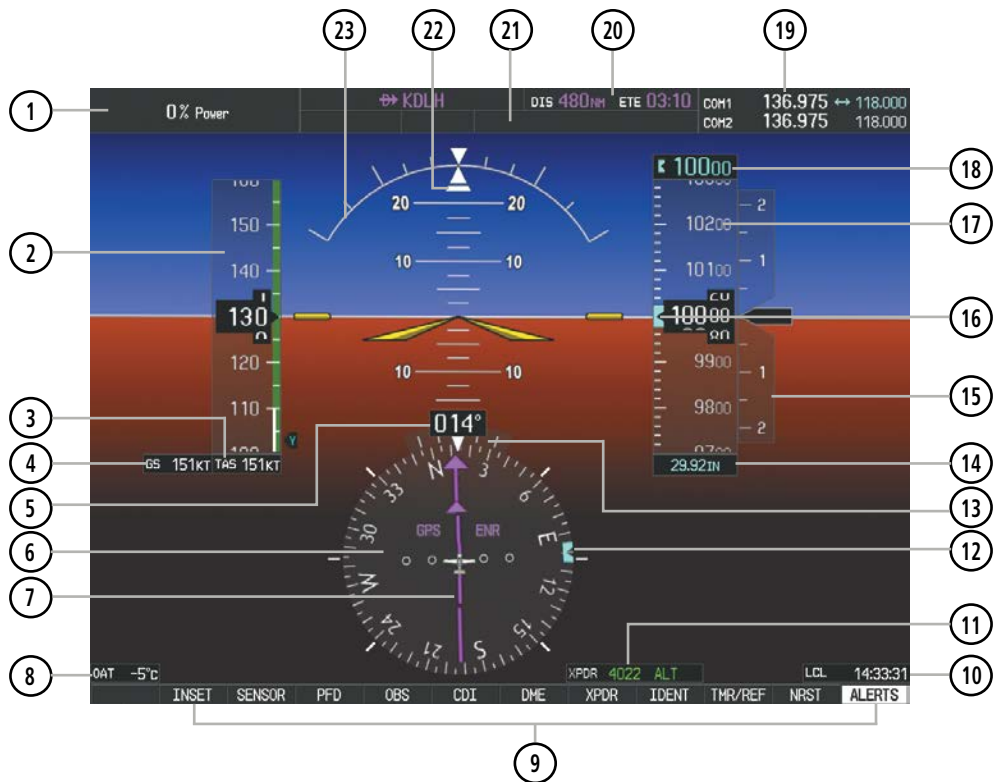

- ① Percent Power Box
- ② Airspeed Indicator
- ③ True Airspeed
- ④ Ground Speed
- ⑤ Current Heading
- ⑥ Horizontal Situation Indicator (HSI)
- ⑦ Course Deviation Indicator (CDI)
- ⑧ Outside Air Temperature (OAT)
- ⑨ Softkeys
- ⑩ System Time
- ⑪ Transponder Status Box
- ⑫ Selected Heading Bug
- ⑬ Turn Rate Indicator
- ⑭ Barometric Altimeter Setting
- ⑮ Vertical Speed Indicator (VSI)
- ⑯ Selected Altitude Bug
- ⑰ Altimeter
- ⑱ Selected Altitude
- ⑲ COM Frequency Box
- ⑳ Navigation Status Box
- ㉑ AFCS Status Box
- ㉒ Slip/Skid Indicator
- ㉓ Attitude Indicator

Figure 2-1 Primary Flight Display (Default)



Figure 2-2 Primary Flight Display (Additional Information)

2.1 FLIGHT INSTRUMENTS

AIRSPPEED INDICATOR

NOTE: Refer to the pertinent flight manual for speed criteria and Vspeed values.

The Airspeed Indicator displays airspeed on a moving tape rolling number gauge. The numeric labels and major tick marks on the moving tape are shown at intervals of 10 knots. The minor tick marks on the moving tape are shown at intervals of five knots. Speed indication starts at 20 knots, with 56 knots of airspeed viewable at any time. The indicated airspeed is displayed inside the black pointer. The pointer remains black until reaching the never-exceed speed (V_{NE}), at which point it turns red. The true airspeed is displayed in knots below the Airspeed Indicator. The Ground Speed appears in knots to the left of the true airspeed.

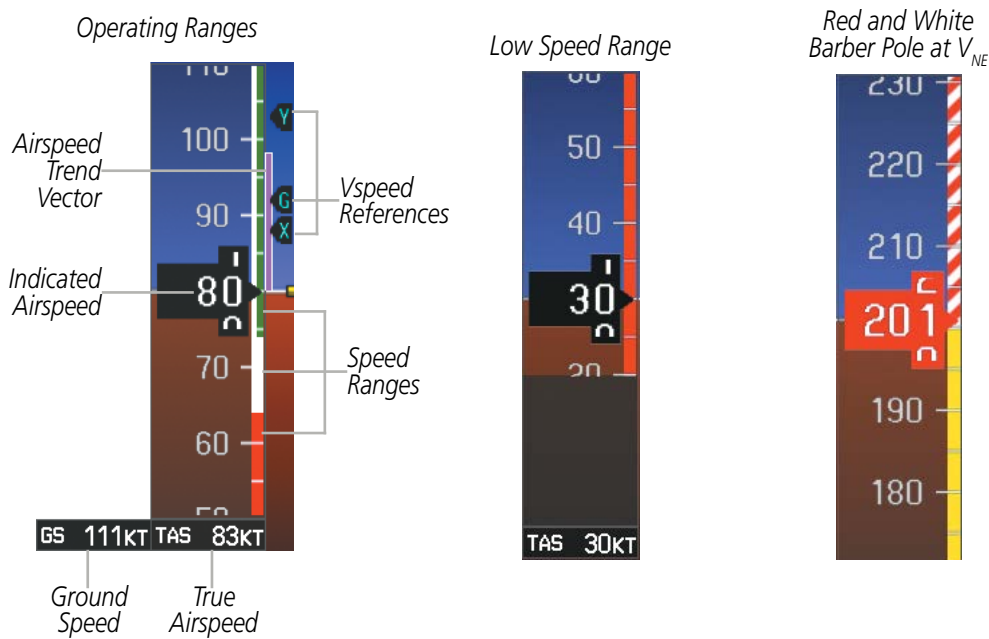

Figure 2-3 Airspeed Indicator Ranges

Color coded stripes appear on the Airspeed Indicator to show the operating ranges. The low speed range stripe is red. Normal operating range is green, caution range is amber, and the never exceed speed (V_{NE}) begins with a red and white barber pole. The flap operating range is indicated by a white stripe.

A red low speed awareness band extends up to the low speed awareness velocity, V_{LSA} .

NOTE: The ice protection system (optional) must be operated in accordance with the pertinent flight manual limitations. This option is only available in SR22 models.

The Airspeed Trend Vector is a vertical magenta line that appears to the right of the color-coded speed range strip when airspeed is either accelerating or decelerating. One end of the magenta line is anchored to the tip of the airspeed pointer while the other end moves continuously up or down corresponding to the rate of acceleration or deceleration. For any constant rate of acceleration or deceleration, the moving end of the line shows approximately what the indicated airspeed value will be in six seconds. If the trend vector crosses V_{NE} , the indicated airspeed number changes to amber. The trend vector is absent if the speed remains constant or if any data needed to calculate airspeed is not available due to a system failure.

Vspeeds (Glide, V_R , V_X , and V_Y) bugs can be turned on/off from the Timer/References Window. V_R is categorized as rotation Vspeed. When active (on), the Vspeeds are displayed at their respective locations to the right of the airspeed scale. All airspeed reference changes are restored to their default values when power is cycled.



NOTE: V_X and/or V_Y are only modifiable on some models.

Changing airspeed references and turning reference bugs on/off:

- 1) Press the **TMR/REF** Softkey.
- 2) Turn the large **FMS** Knob to highlight the ON/OFF field or a speed.
- 3) Turn the small **FMS** Knob clockwise to ON or counterclockwise to OFF, or clockwise to increase a speed and counterclockwise to decrease a speed. Modified speeds will have an * next to them.
- 4) To remove the window, press the **CLR** Key or the **TMR/REF** Softkey.

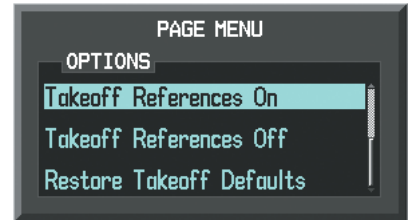
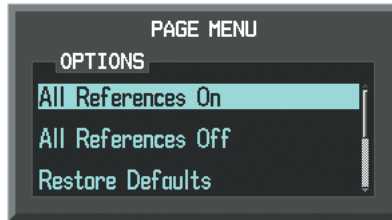

Figure 2-4 Timer/References Window and Menus

Airspeed reference bugs can be turned on or off all at once or by category.

Turning airspeed reference bugs on/off as a group:

- 1) Press the **TMR/REF** Softkey.
- 2) Press the **MENU** Key.
- 3) Press the **ENT** Key with 'All References On', 'All References Off', 'Takeoff References On', 'Takeoff References Off' highlighted. The selected self-descriptive option occurs.

Restoring airspeed reference defaults:

- 1) Press the **TMR/REF** Softkey.
- 2) Press the **MENU** Key.
- 3) Turn the **FMS** Knob to highlight 'Restore Defaults' or 'Restore Takeoff Defaults' and press the **ENT** Key.

ATTITUDE INDICATOR

Attitude information is displayed over a virtual blue sky and brown ground with a white horizon line. The Attitude Indicator displays the pitch, roll, and slip/skid information.

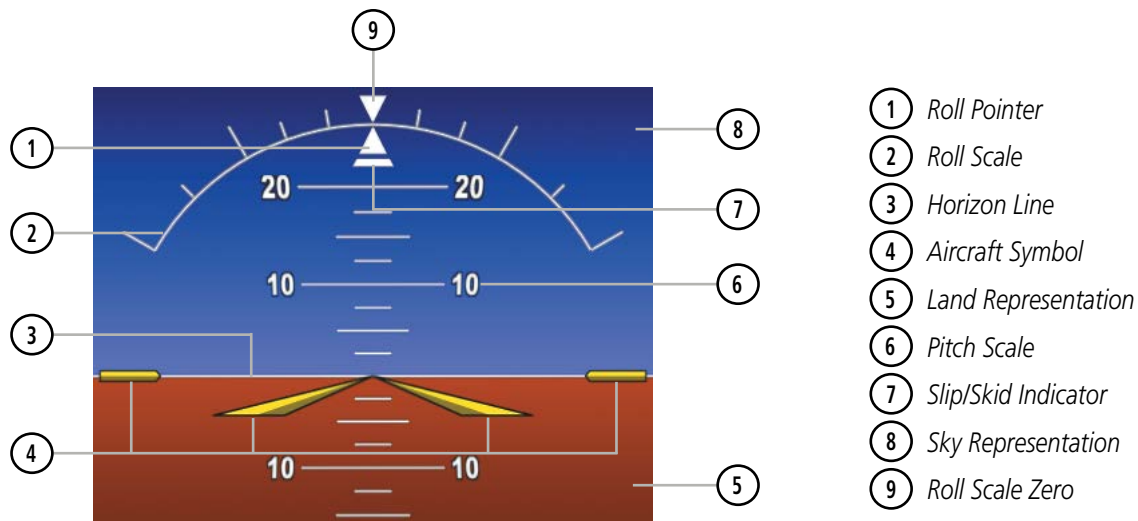

Figure 2-5 Attitude Indicator

The horizon line is part of the pitch scale. Above and below the horizon line, major pitch marks and numeric labels are shown for every 10°, up to 80°. Minor pitch marks are shown for intervening 5° increments, up to 25° below and 45° above the horizon line. Between 20° below to 20° above the horizon line, minor pitch marks occur every 2.5°. When the optional Synthetic Vision Technology (SVT) system is activated, the pitch scale is reduced to 10° up and 7.5° down; refer to the Additional Features section for more information about SVT.

The inverted white triangle indicates zero on the roll scale. Major tick marks at 30° and 60° and minor tick marks at 10°, 20°, and 45° are shown to the left and right of the zero. When the optional Electronic Stability and Protection (ESP™) system is available, double ticks marks also appear on the roll scale; refer to the Additional Features section for more information about ESP™ indications. Angle of bank is shown by the position of the pointer on the roll scale.

The Slip/Skid Indicator is the bar beneath the roll pointer. The indicator moves with the roll pointer and moves laterally away from the pointer to indicate lateral acceleration. Slip/skid is indicated by the location of the bar relative to the pointer.



Figure 2-6 Slip/Skid Indication

ALTIMETER

The Altimeter displays 600 feet of barometric altitude values at a time on a moving tape rolling number gauge. Numeric labels and major tick marks are shown at intervals of 100 feet. Minor tick marks are at intervals of 20 feet. The indicated altitude is displayed inside the black pointer.

The Selected Altitude is displayed above the Altimeter in the box indicated by a selection bug symbol. A bug corresponding to this altitude is shown on the tape. If the Selected Altitude exceeds the range shown on the tape, the bug appears at the upper or lower edge of the tape. When the metric value is selected it is displayed in a separate box above the Selected Altitude.

When a Selected Altitude is set, a light blue Selected Altitude Intercept Arc (if enabled) is displayed on the navigation maps when the aircraft is climbing or descending. This arc appears at the estimated position the aircraft will intercept the Selected Altitude; refer to the Flight Management Section for additional information about the Selected Altitude Intercept Arc.

Setting the Selected Altitude:

Turn the **ALT SEL** Knob to set the Selected Altitude in 100-ft increments up to the aircraft’s service ceiling. When meters are displayed, Selected Altitude is adjusted in 50-meter increments.

If set, the Minimum Altitude Alert value is also available for the Selected Altitude.

If desired, push the **ALT SEL** Knob to synchronize the selected altitude to the indicated altitude to the nearest 10 ft.

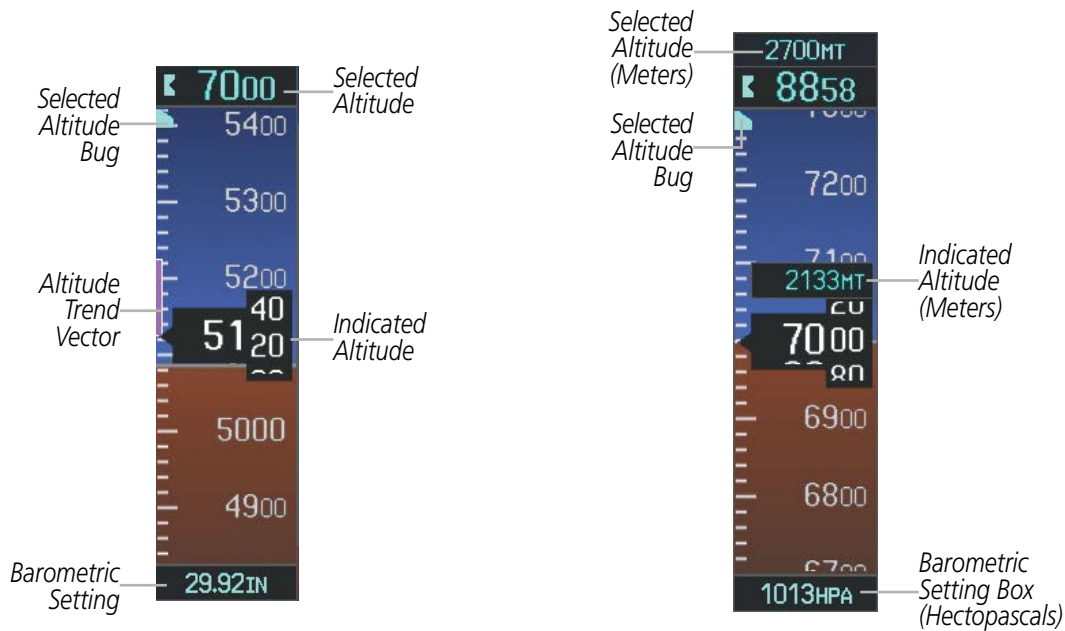

Figure 2-7 Altimeter Settings, in Hg and hPa

Altitudes can also be displayed in meters (prior figure). Note that the altitude tape does not change scale.

Displaying altitude in meters:

- 1) Press the **PFD** Softkey to display the second-level softkeys.
- 2) Press the **ALT UNIT** Softkey.
- 3) Press the **METERS** Softkey to turn on metric altitude readouts.
- 4) Press the **BACK** Softkey to return to the top-level softkeys.

A magenta Altitude Trend Vector extends up or down the left of the altitude tape, the end resting at the approximate altitude to be reached in six seconds at the current vertical speed. The trend vector is not shown if altitude remains constant or if data needed for calculation is not available due to a system failure.

The barometric pressure setting is displayed below the Altimeter in inches of mercury (in Hg) or hectopascals (hPa) when metric units are selected. Adjusting the altimeter barometric pressure setting creates discontinuities in VNV vertical navigation, moving the descent path. For large adjustments, it may take several minutes for the aircraft to re-establish on the descent path. If the change is made while nearing a waypoint with a VNV Target Altitude, the aircraft may not re-establish on the descent path in time to meet the vertical constraint.



WARNING: Do not use a QFE altimeter setting with this system. System functions will not operate properly with a QFE altimeter setting. Use only a QNH altimeter setting for height above mean sea level, or the standard pressure setting, as applicable.

Selecting the altimeter barometric pressure setting:

Turn the **BARO** Knob to select the desired setting.

Selecting standard barometric pressure:

Push the **BARO** Knob to select standard pressure; STD BARO is displayed in the Barometric Setting box.

Or:

- 1) Press the **PFD** Softkey to display the second-level softkeys.
- 2) Press the **STD BARO** Softkey; STD BARO is displayed in the Barometric Setting box.

Figure 2-8 Standard Barometric Altimeter Setting

Changing altimeter barometric pressure setting units:

- 1) Press the **PFD** Softkey to display the second-level softkeys.
- 2) Press the **ALT UNIT** Softkey.
- 3) Press the **IN** Softkey to display the barometric pressure setting in inches of mercury (in Hg).
Or, press the **HPA** Softkey to display the barometric pressure setting in hectopascals (hPa).
- 4) Press the **BACK** Softkey twice to return to the top-level softkeys.

VERTICAL SPEED INDICATOR (VSI)

The Vertical Speed Indicator (VSI) displays the aircraft vertical speed with numeric labels and tick marks at 1000 and 2000 fpm in each direction on the non-moving tape. Minor tick marks are at intervals of 500 fpm. The current vertical speed is displayed in the pointer, which also points to that speed on the non-moving tape. Digits appear in the pointer when the climb or descent rate is greater than 100 fpm. If the rate of ascent/descent exceeds 2000 fpm, the pointer appears at the corresponding edge of the tape and the rate appears inside the pointer.

A magenta chevron bug is displayed as the Required Vertical Speed Indication (RVSI; Figure 2-9) for reaching a VNV Target Altitude once the “TOD [Top of Descent] within 1 minute” alert has been generated. See the Flight Management and AFCS sections for details on VNV features, and refer to Section 2.2, Supplemental Flight Data, for more information about VNV indications on the PFD.

VERTICAL DEVIATION

The Vertical Deviation Indicator (VDI; Figure 2-9) uses a magenta chevron to indicate the VNV vertical deviation when Vertical Navigation (VNV) is being used; the VDI appears in conjunction with the “TOD within 1 minute” alert. Full-scale deflection (two dots) is 1000 feet. The VDI is removed from the display if vertical deviation becomes invalid. See the Flight Management and AFCS sections for details on VNV features, and refer to Section 2.2, Supplemental Flight Data, for more information about VNV indications on the PFDs.

The Glideslope Indicator (Figure 2-10) appears to the left of the Altimeter whenever an ILS frequency is tuned in the active NAV field and the aircraft heading and selected course are within 107°. A green diamond acts as the Glideslope Indicator, like a glideslope needle on a conventional indicator. If a localizer frequency is tuned and there is no glideslope, “NO GS” is displayed in place of the diamond.



NOTE: *The Glidepath Indicator appears on the display as soon as the Final Approach Fix (FAF) becomes the active waypoint. Depending on procedure design, pilot action, and/or ATC clearance, the aircraft may be centered on or above the glidepath when the Glidepath Indicator appears.*

The Glidepath Indicator is a vertical deviation scale for RNAV GPS approaches supporting SBAS vertical guidance (LNAV+V, L/VNAV, LPV, and LP+V service levels). The Glidepath Indicator, a magenta diamond (Figure 2-11) appears on the display as soon as the Final Approach Fix (FAF) becomes the active waypoint, and FMS is the selected navigation source. Full-scale deflection (two dots), is angular with upper and lower limits. The upper limit is ±150 meters and lower limits depend on approach service level.

- LNAV/VNAV is ±45 meters.
- LPV/LP+V is ±15 meters.

If the approach service level downgrades past the final approach fix (FAF), “NO GP” is displayed in place of the diamond.

SYSTEM OVERVIEW

FLIGHT INSTRUMENTS

EIS

AUDIO PANEL & CNS

FLIGHT MANAGEMENT

HAZARD AVOIDANCE

AFCS

ADDITIONAL FEATURES

APPENDICES

INDEX

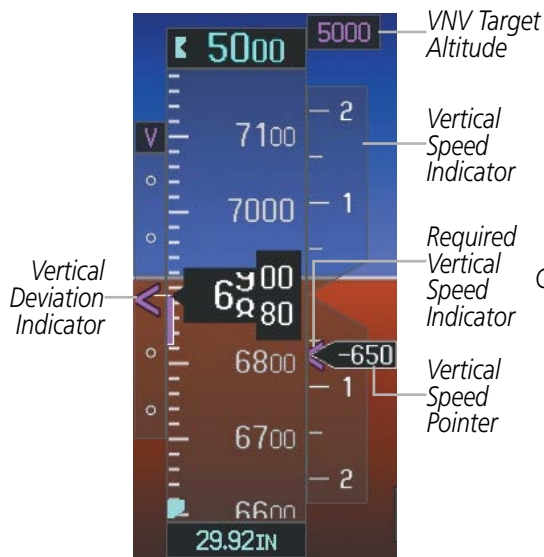

Figure 2-9 Vertical Speed and Deviation Indicators (VSI and VDI)

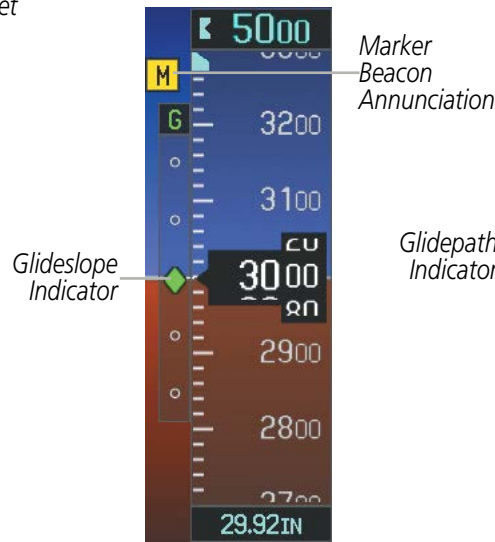

Figure 2-10 Glideslope Indicator

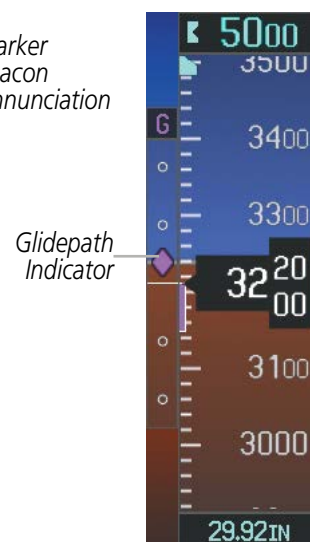

Figure 2-11 Glidepath Indicator

HORIZONTAL SITUATION INDICATOR (HSI)

The Horizontal Situation Indicator (HSI) displays a rotating compass card in a heading-up orientation. Letters indicate the cardinal points and numeric labels occur every 30°. Major tick marks are at 10° intervals and minor tick marks at 5° intervals. A digital reading of the current heading appears on top of the HSI, and the current track is represented on the HSI by a magenta diamond bug. The HSI also presents turn rate, course deviation, bearing, and navigation source information and is available in two formats (360° compass rose and 140° arc).

Changing the HSI display format:

- 1) Press the **PFD** Softkey.
- 2) Press the **HSI FRMT** Softkey.
- 3) Press the **360 HSI** or **ARC HSI** Softkey.

The 360° HSI contains a Course Deviation Indicator (CDI), with a Course Pointer, To/From Indicator, and a sliding deviation bar and scale. The course pointer is a single line arrow (GPS, VOR1, and LOC1) or a double line arrow (VOR2 and LOC2) which points in the direction of the set course. The To/From arrow rotates with the course pointer and is displayed when the active NAVAID is received.

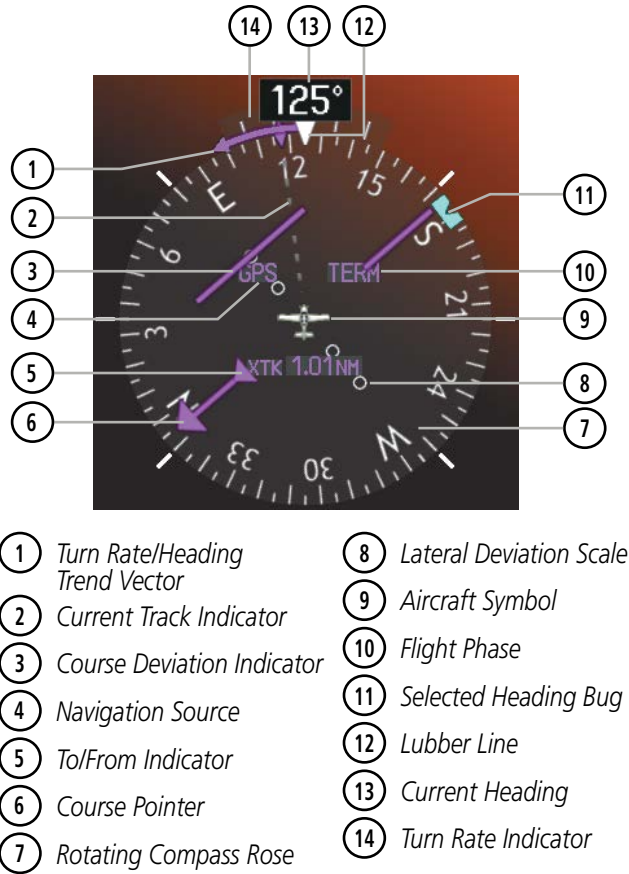

Figure 2-12 Horizontal Situation Indicator (HSI)

The Arc HSI is a 140° expanded section of the compass rose. The Arc HSI contains a Course Pointer, To/From Indicator, a sliding deviation indicator (the To/From and deviation indicators are combined), and a deviation scale. Upon station passage, the To/From Indicator flips and points to the tail of the aircraft, just like a conventional To/From flag. Depending on the navigation source, the CDI on the Arc HSI can appear in two different ways: an arrowhead (GPS, VOR, OBS) or a diamond (LOC).

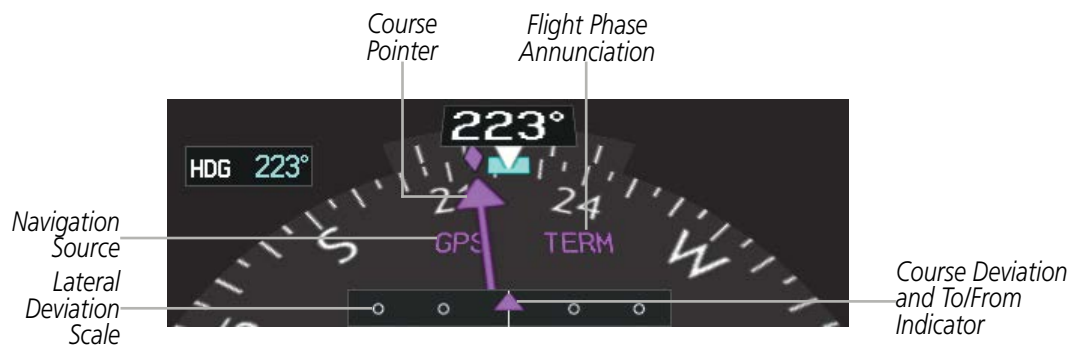

Figure 2-13 ARC HSI

The Selected Heading is shown to the upper left of the HSI for 3 seconds after being adjusted. The light blue bug on the compass rose corresponds to the Selected Heading. While the HSI is displayed as an arc, if the Selected Heading Bug is adjusted off the shown portion of the compass rose, the digital reading is displayed.

Adjusting the Selected Heading:

Turn the **HDG** Knob to set the Selected Heading.

Push the **HDG** Knob to synchronize the bug to the current heading.

The Selected Course is shown to the upper right of the HSI for 3 seconds after being adjusted. While the HSI is displayed as an arc, the Selected Course is displayed whenever the Course Pointer is not within the 140° currently shown.

Adjusting the Selected Course:

Turn the **CRS** Knob to set the Selected Course.

Push the **CRS** Knob to re-center the CDI and return the course pointer to the bearing of the active waypoint or navigation station (see OBS Mode for adjusting a GPS course).

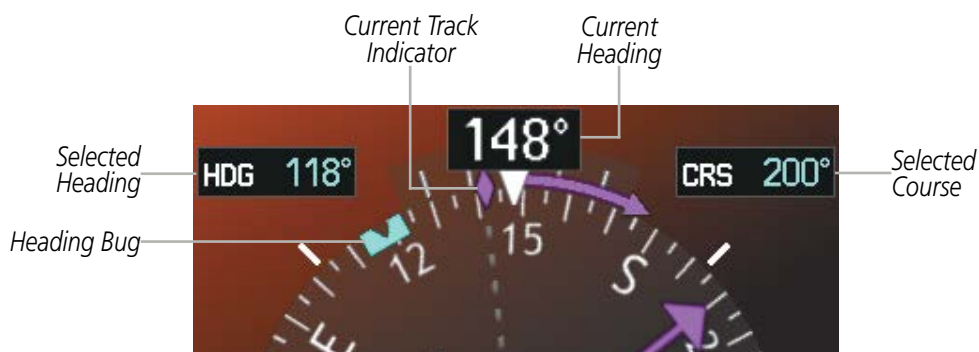

Figure 2-14 Heading and Course Indications (Magnetic)

Navigation angles (track, heading, course, bearing) are corrected to the computed magnetic variation (Mag Var) or referenced to true north (T), set on the 'AUX - System Setup' Page. When an approach referenced to true north has been loaded into the flight plan, the system generates a message to change the navigation angle setting to True at the appropriate time.



Figure 2-15 Heading and Course Indications (True)

Changing the navigation angle setting:

- 1) Use the **FMS** Knob to select the 'AUX - System Setup' Page on the MFD.
- 2) Push the **FMS** Knob to activate the cursor.
- 3) Turn the large **FMS** Knob to highlight Nav Angle in the Display Units box.

- 4) Turn the small **FMS** Knob to highlight the desired setting and press the **ENT** Key.
 - MAGNETIC (°)- Angles corrected to the computed magnetic variation (Mag Var)
 - TRUE (°T)- References angles to true north (T)



Figure 2-16 Navigation Angle Settings ('AUX - System Setup' Page)

TURN RATE INDICATOR

The Turn Rate Indicator is located directly above the rotating compass card. Tick marks to the left and right of the lubber line denote half-standard and standard turn rates. A magenta Turn Rate Trend Vector shows the current turn rate. The end of the trend vector gives the heading predicted in 6 seconds, based on the present turn rate. A standard-rate turn is shown on the indicator by the trend vector stopping at the standard turn rate tick mark, corresponding to a predicted heading of 18° from the current heading. At rates greater than 4 deg/sec, an arrowhead appears at the end of the magenta trend vector and the prediction is no longer valid.

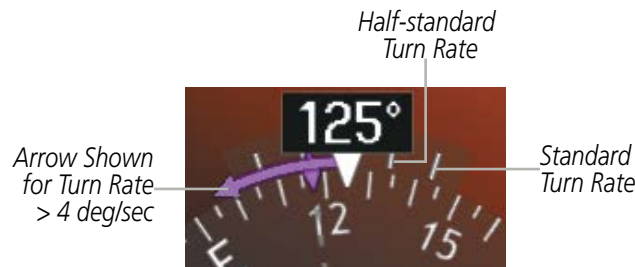

Figure 2-17 Turn Rate Indicator and Trend Vector

BEARING POINTERS AND INFORMATION WINDOWS

NOTE: When the Arc HSI is displayed, the Bearing Information windows and pointers are disabled.

Two bearing pointers (the second of which is an optional feature) and associated information can be displayed on the HSI for the NAV, GPS, and ADF sources. The bearing pointers are light blue and are single-line (BRG1) or double-line (BRG2). A pointer symbol is shown in the information window to indicate the navigation source. The bearing pointers never override the CDI and are visually separated from the CDI by a white ring. Bearing pointers may be selected but not necessarily visible due to data unavailability.

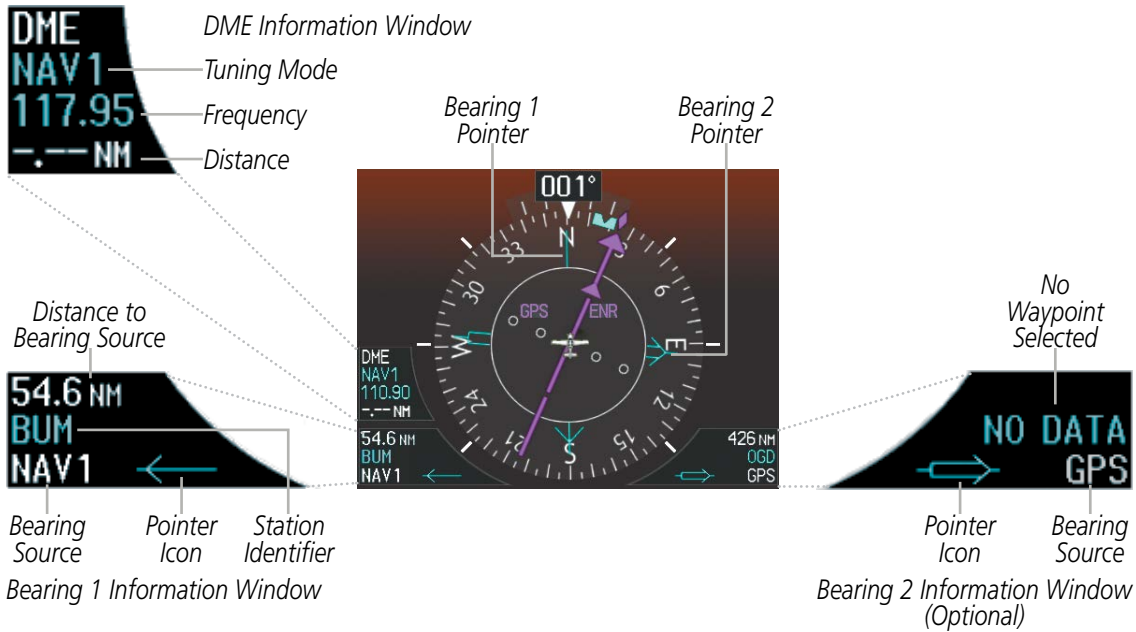

Figure 2-18 HSI with Bearing and DME Information

When a bearing pointer is displayed, the associated information window is also displayed. The Bearing Information Windows are displayed at the lower sides of the HSI and give the following information:

- Bearing source (NAV, GPS)
- Pointer icon (BRG = single line)
- Frequency (NAV, ADF)
- Station/waypoint identifier (NAV, GPS)
- GPS-derived great circle distance to bearing source

If the NAV radio is the bearing source and is tuned to an ILS frequency (refer to the Audio Panel and CNS Section for information on tuning the radios), the bearing pointer is removed from the HSI and the frequency is replaced with “ILS”. When NAV1 or NAV2 is the selected bearing source, the frequency is replaced by the station identifier when the station is within range. If GPS is the bearing source, the active waypoint identifier is displayed in lieu of a frequency.

The bearing pointer is removed from the HSI and “NO DATA” is displayed in the information window if:

- The NAV radio is not receiving the tuned VOR station
- GPS is the bearing source and an active waypoint is not selected

Selecting bearing display and changing sources:

- 1) Press the **PFD** Softkey.
- 2) Press the **BRG** Softkey to display the bearing pointer and information window with NAV1 source.
- 3) Press the **BRG** Softkey again to change the bearing source to NAV2.
- 4) Press the **BRG** Softkey a third time to change the bearing source to GPS.
- 5) Press the **BRG** Softkey a fourth time to change the bearing source to ADF (optional).
- 6) To remove the bearing pointer and information window, press the **BRG** Softkey again.

DME INFORMATION WINDOW

The DME Information Window is displayed above the BRG1 Information Window on the 360° HSI and in a box above and alongside the Arc HSI. It shows the DME label, tuning mode (NAV1, NAV2, or HOLD), frequency, and distance. When a signal is invalid, the distance is replaced by “- . - - NM”. Refer to the Audio Panel and CNS Section for information on tuning the DME.

Displaying the DME Information Window:

- 1) Press the **PFD** Softkey.
- 2) Press the **DME** Softkey to display the DME Information Window.
- 3) To remove the DME Information Window, press the **DME** Softkey again.

COURSE DEVIATION INDICATOR (CDI)

The Course Deviation Indicator (CDI) moves left or right from the course pointer along a lateral deviation scale to display aircraft position relative to the course. If the course deviation data is not valid, the CDI is not displayed.

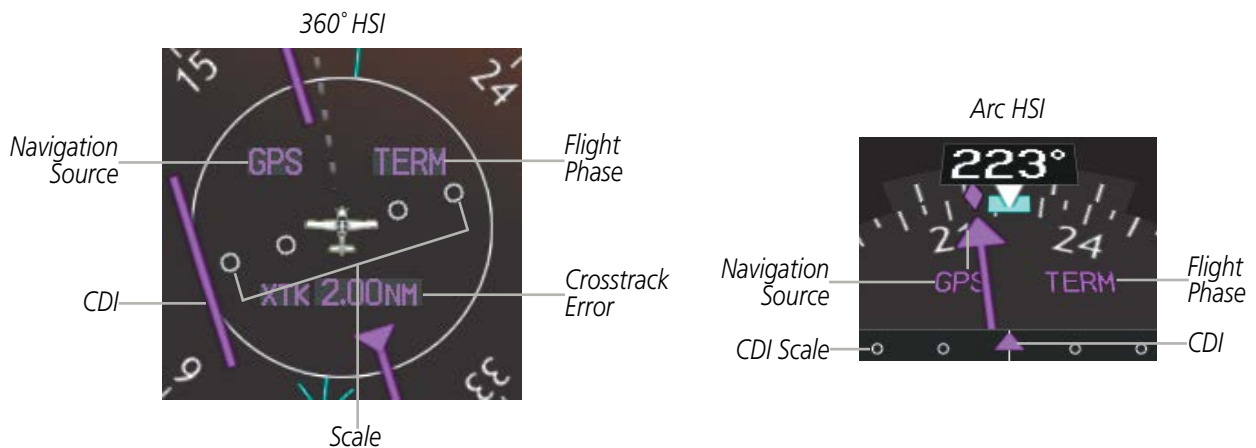

Figure 2-19 Course Deviation Indicator

The CDI can display two sources of navigation: GPS or NAV (VOR, localizer). Color indicates the current navigation source: magenta (for GPS) or green (for VOR and LOC); the Selected Course readout also follows these color indications. When coupled to GPS, the full scale limits for the CDI are defined by a GPS-derived

distance. When coupled to a VOR or localizer (LOC), the CDI has the same angular limits as a mechanical CDI. If the CDI exceeds the maximum deviation on the scale (two dots) while coupled to GPS, the cross-track error (XTK) is displayed below the white aircraft symbol.



Figure 2-20 Navigation Sources

Changing navigation sources:

- 1) Press the **CDI** Softkey to change from GPS to VOR1 or LOC1. The NAV1 standby frequency in the upper left corner of the MFD is light blue.
- 2) Press the **CDI** Softkey again to change from VOR1 or LOC1 to VOR2 or LOC2. The NAV2 standby frequency in the upper left corner of the MFD is light blue.
- 3) Press the **CDI** Softkey a third time to return to GPS.

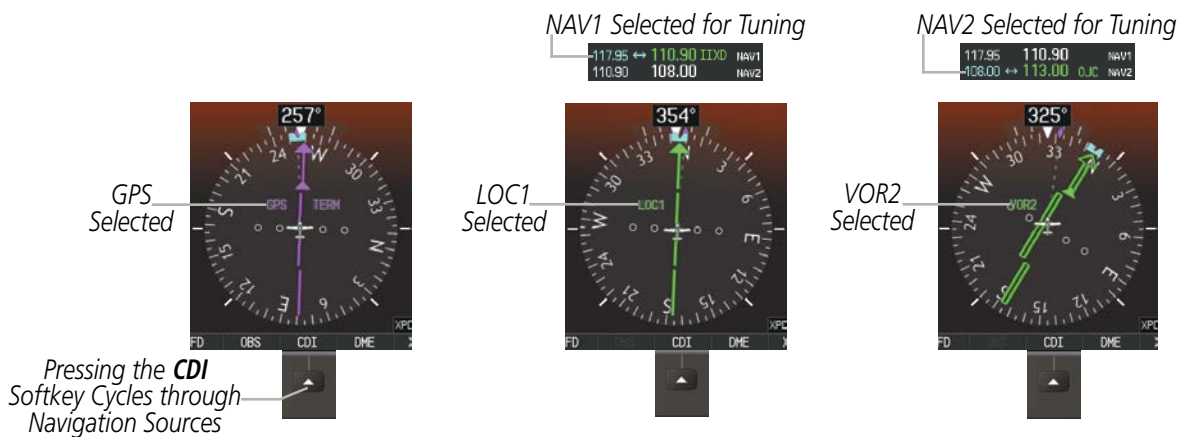

Figure 2-21 Selecting a Navigation Source

The system automatically switches from GPS to LOC navigation source and changes the CDI scaling accordingly when all of the following occur:

- A localizer or ILS approach has been loaded into the active flight plan
- The Final Approach Fix (FAF) is the active leg, the FAF is less than 15 nm away, and the aircraft is moving toward the FAF

- A valid localizer frequency has been tuned
- The GPS CDI deviation is less than 1.2 times full-scale deflection

GPS steering guidance is still provided after the CDI automatically switches to LOC until LOC capture, up to the Final Approach Fix (FAF) for an ILS approach, or until GPS information becomes invalid. Activating a Vector-to-Final (see the Flight Management Section) also causes the CDI to switch to LOC navigation source; GPS steering guidance is not provided after this switch.

GPS CDI SCALING

When GPS is the selected navigation source, the flight plan legs are sequenced automatically and annunciations appear on the HSI for the flight phase. Flight phase annunciations are normally shown in magenta, but when cautionary conditions exist the color changes to amber. If the current leg in the flight plan is a heading leg, 'HDG LEG' is annunciated in magenta beneath the aircraft symbol.

The current GPS CDI scale setting is displayed as 'System CDI' on the 'AUX - System Setup' Page and the full-scale deflection setting may also be changed (2.0 nm, 1.0 nm, 0.3 nm, or Auto) from this page. If the selected scaling is smaller than the automatic setting for enroute and terminal phases, the CDI is scaled accordingly and the selected setting is displayed rather than the flight phase annunciation. Receiver Autonomous Integrity Monitoring (RAIM) protection limits follow the selected CDI scale and corresponding flight phases.

Changing the selected GPS CDI setting:

- 1) Use the **FMS** Knob to select the 'AUX - System Setup' Page on the MFD.
- 2) Push the **FMS** Knob to activate the cursor.
- 3) Turn the large **FMS** Knob to highlight Selected in the GPS CDI box.
- 4) Turn the small **FMS** Knob to highlight the desired setting and press the **ENT** Key.
- 5) To cancel the selection, push the **FMS** Knob or the **CLR** Key.



Figure 2-22 GPS CDI Settings ('AUX - System Setup' Page)

When set to 'Auto' (default), the GPS CDI scale automatically adjusts to the desired limits based upon the current phase of flight (following figure and table).

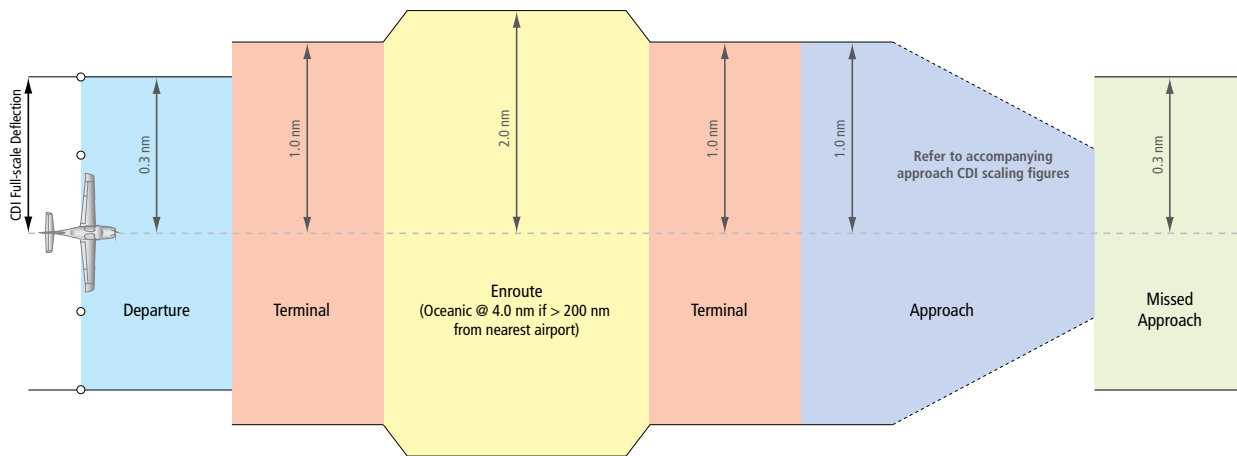

Figure 2-23 Automatic CDI Scaling

- Once a departure procedure is activated, the CDI is scaled for **departure** (0.3 nm).
- The system switches from departure to **terminal** CDI scaling (1.0 nm) under the following conditions:
 - The next leg in the departure procedure is not aligned with the departure runway
 - The next leg in the departure procedure is not a CA, CD, CF, CI, CR, DE, FA, FC, FD, FM, IF, or TF leg
 - After any leg in the departure procedure that is not a CA or FA leg
- At 30 nm from the departure airport the **enroute** phase of flight is automatically entered and CDI scaling changes to 2.0 nm over a distance of 1.0 nm, except under the following conditions:
 - When navigating with an active departure procedure, the flight phase and CDI scale does not change until the aircraft arrives at the last departure waypoint (if more than 30 nm from the departure airport) or the leg after the last departure waypoint has been activated or a direct-to waypoint is activated.
- If after completing the departure procedure the nearest airport is more than 200 nm away from the aircraft and the approach procedure has not yet commenced, the CDI is scaled for **oceanic** flight (4.0 nm).
- Within 31 nm of the destination airport (**terminal** area), the CDI scale gradually ramps down from 2.0 nm to 1.0 nm over a distance of 1.0 nm, except under the following conditions:
 - Upon reaching the first waypoint of an arrival route that is more than 31 nm from the destination airport, the flight phase changes to terminal and the CDI scale begins to transition down from 2.0 nm to 1.0 nm over a distance of 1.0 nm.
- During **approach**, the CDI scale ramps down even further (see Figure 2-24 and Figure 2-25). This transition normally occurs within 2.0 nm of the Final Approach Fix (FAF). The CDI switches to approach scaling automatically once the approach procedure is active or if Vectors-To-Final (VTF) are selected.
 - If the active waypoint is the FAF, the ground track and the bearing to the FAF must be within 45° of the final approach segment course.

- If the active waypoint is part of the missed approach procedure, the active leg and the preceding missed approach legs must be aligned with the final approach segment course and the aircraft must not have passed the turn initiation point.

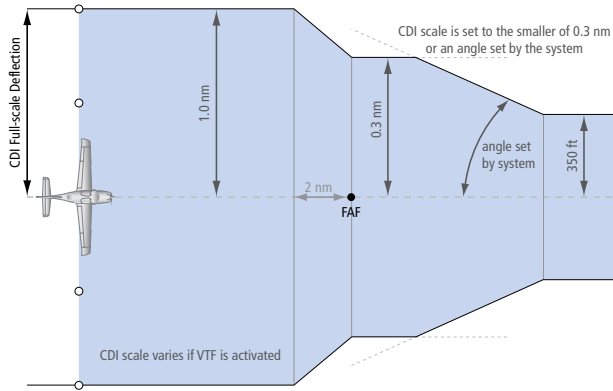

Figure 2-24 Typical LNAV and LNAV+V Approach Service Level CDI Scaling

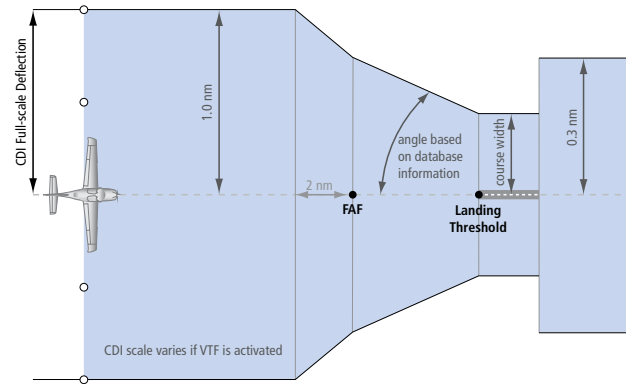

Figure 2-25 Typical LNAV/VNAV, LPV, LP, and LP+V Approach Service Level CDI Scaling

- When a **missed approach** is activated, the CDI scale changes to 0.3 nm.
- The system automatically switches back to **terminal** mode under the following conditions:
 - The next leg in the missed approach procedure is not aligned with the final approach path
 - The next leg in the missed approach procedure is not a CA, CD, CF, CI, CR, DF, FA, FC, FD, FM, IF, or TF leg
 - After any leg in the missed approach procedure that is not a CA or FA leg

Flight Phase	Annunciation*	Automatic CDI Full-scale Deflection
Departure	DPRT	0.3 nm
Terminal	TERM	1.0 nm
Enroute	ENR	2.0 nm
Oceanic	OCN	4.0 nm
Approach LNAV LNAV+V	LNAV LNAV+V	1.0 nm decreasing to 350 feet depending on variables (see Figure 2-24)
Approach LNAV/VNAV LPV LP LP+V	L/VNAV LPV LP LP+V	1.0 nm decreasing to a specified course width, then 0.3 nm, depending on variables (see Figure 2-25)
Missed Approach	MAPR	0.3 nm

* Flight phase annunciations are normally shown in magenta, but when cautionary conditions exist the color changes to amber.

Table 2-1 Automatic GPS CDI Scaling

OBS MODE



NOTE: VNV is inhibited while automatic waypoint sequencing has been suspended.

Enabling Omni-bearing Selector (OBS) Mode suspends the automatic sequencing of waypoints in a GPS flight plan (GPS must be the selected navigation source), but retains the current “active-to” waypoint as the navigation reference even after passing the waypoint. ‘OBS’ is annunciated to the lower right of the aircraft symbol on the moving map when OBS Mode is selected.

While OBS Mode is enabled, a course line is drawn through the “active-to” waypoint on the moving map. If desired, the course to/from the waypoint can now be adjusted. When OBS Mode is disabled, the GPS flight plan returns to normal operation with automatic sequencing of waypoints, following the course set in OBS Mode. The flight path on the moving map retains the modified course line.

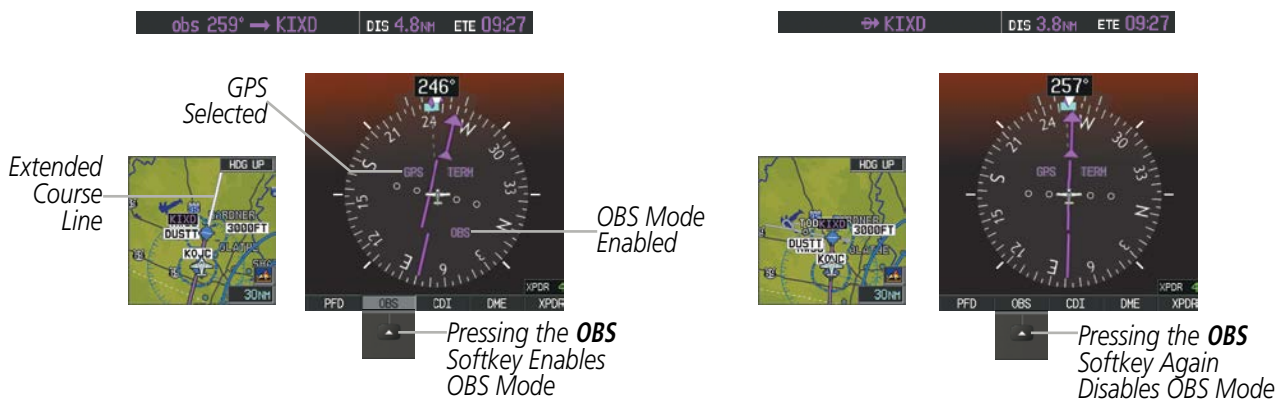

Figure 2-26 Omni-bearing Selector (OBS) Mode

Enabling/disabling OBS Mode while navigating a GPS flight plan:

- 1) Press the **OBS** Softkey to select OBS Mode.
- 2) Turn a **CRS** Knob to select the desired course to/from the waypoint. Push a **CRS** Knob to synchronize the Selected Course with the bearing to the next waypoint.
- 3) Press the **OBS** Softkey again to return to automatic waypoint sequencing.

As the aircraft crosses the missed approach point (MAP), automatic approach waypoint sequencing is suspended. **SUSP** appears on the HSI at the lower right of the aircraft symbol. The **OBS** Softkey label changes to indicate the suspension is active as shown in the following figure. Pressing the **SUSP** Softkey deactivates the suspension and resumes automatic sequencing of approach waypoints.

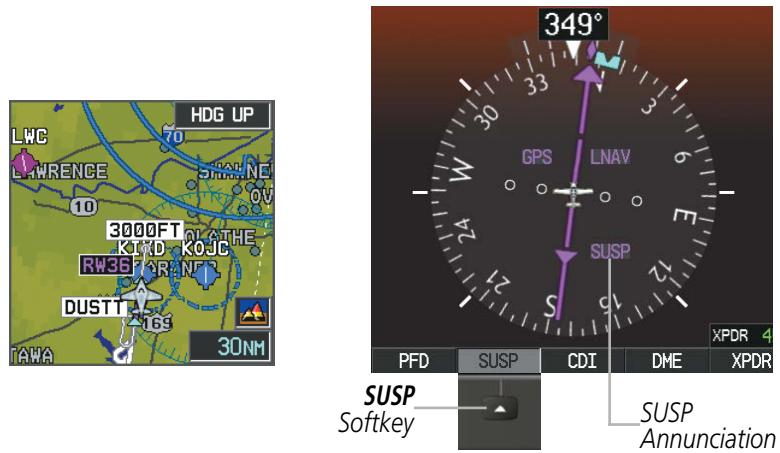

Figure 2-27 Suspending Automatic Waypoint Sequencing

2.2 SUPPLEMENTAL FLIGHT DATA



NOTE: Pressing the *DFLTS* Softkey (a second-level PFD softkey) turns off metric altimeter display, the Inset Map, and wind data display.

In addition to the flight instruments, the PFD also displays various supplemental information, including temperatures, wind data, and Vertical Navigation (VNV) indications.

TEMPERATURE DISPLAY

The Outside Air Temperature (OAT) is displayed in degrees Celsius (°C) by default in the lower left of the PFD under normal display conditions, or below the true airspeed in reversionary mode. It may also be displayed in degrees Fahrenheit from the ‘AUX - System Setup’ Page on the MFD.

Normal Display



OAT 9°C

Reversionary Mode



Figure 2-28 Outside Air Temperature

- SYSTEM OVERVIEW
- FLIGHT INSTRUMENTS
- EIS
- AUDIO PANEL & CNS
- FLIGHT MANAGEMENT
- HAZARD AVOIDANCE
- AFCS
- ADDITIONAL FEATURES
- APPENDICES
- INDEX

Changing temperature display units:

- 1) Select the 'AUX - System Setup' Page on the MFD using the **FMS** Knob.
- 2) Push the **FMS** Knob to activate the cursor.
- 3) Turn the large **FMS** Knob to highlight the TEMP field in the Display Units box.
- 4) Turn the small **FMS** Knob to highlight either CELSIUS or FAHRENHEIT and press the **ENT** Key to confirm the selection.
- 5) To cancel the selection, push the **FMS** Knob or the **CLR** Key.

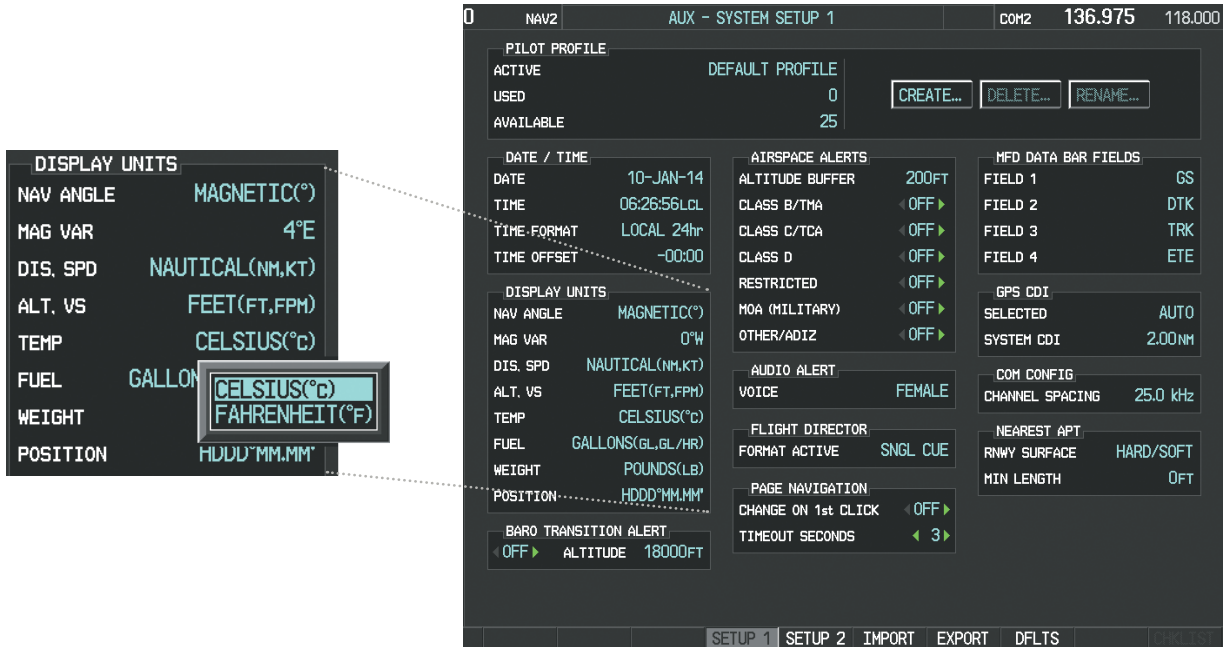

Figure 2-29 Temperature Selection ('AUX - System Setup' Page)

WIND DATA

Wind direction and speed in knots can be displayed relative to the aircraft in a window to the upper left of the HSI. When the window is selected for display, but wind information is invalid or unavailable, the window displays NO WIND DATA. Wind data can be displayed in two different ways.



Figure 2-30 Wind Data

Displaying wind data:

- 1) Press the **PFD** Softkey.
- 2) For airframes without AOA option, press the **WIND** Softkey then proceed to the next step.
Or:
For airframes with AOA option, press the **AOA/WIND** Softkey then the **WIND** Softkey.
- 3) Press one of the **OPTN** softkeys to change how wind data is displayed:
 - **OPTN 1**: Total wind direction arrow with digital true numeric direction and speed.
 - **OPTN 2**: Headwind/tailwind and crosswind arrows with numeric speed components.
- 4) To remove the window, press the **OFF** Softkey.

ANGLE OF ATTACK (AOA) INDICATOR

The Angle of Attack (AOA) Indicator (following figure) appears on the PFD below the airspeed indicator and displays the normalized angle of attack. White, amber, and red arcs indicate AOA ranges for normal, caution, and warning ranges respectively. The pointer color matches the color of the arc associated with the current AOA value.

The pilot can enable/disable the display of the AOA Indicator on the PFD, or select auto mode. When auto is selected, AOA Indicator automatically appears when the AOA is greater than 0.2, or the flaps are extended. Otherwise, the AOA Indicator is removed.



Figure 2-31 Angle of Attack (AOA) Indicator

Selecting the AOA Indicator display mode:

- 1) Press the **PFD** Softkey.
- 2) Press the **AOA/WIND** Softkey, then the **AOA** Softkey.
- 3) Press the **AOA ON** or **AOA AUTO** Softkey (pressing **AOA ON** again will turn the indicator off).

VERTICAL NAVIGATION (VNV) INDICATIONS

When a VNV flight plan has been activated, VNV indications (VNV Target Altitude, RVSI, VDI) appear on the PFD in conjunction with the “TOD within 1 minute” message and “Vertical track” voice alert. See the Flight Management and AFCS sections for details on VNV features. VNV indications are removed from the PFD according to the criteria listed in Table 2-2.



Figure 2-32 Vertical Navigation Indications (PFD)

Criteria	VNV Indication Removed		
	Required Vertical Speed (RVSI)	Vertical Deviation (VDI)	VNV Target Altitude*
Aircraft > 1 min before the next TOD due to flight plan change	X	X	X
VNV cancelled (CNCL VNV Softkey pressed on MFD)	X	X	X
Distance to active waypoint cannot be computed due to unsupported flight plan leg type (see Flight Management Section)	X	X	X
Aircraft > 250 feet below active VNV Target Altitude	X	X	X
Current crosstrack or track angle error has exceeded limit	X	X	X
Active altitude-constrained waypoint can not be reached within maximum allowed flight path angle and vertical speed	X	X	

* If the flight director has been engaged to fly a VNV flight plan, the VNV Target Altitude being held remains displayed while on level flight plan legs.

Table 2-2 VNV Indication Removal Criteria

2.3 PFD ANNUNCIATIONS AND ALERTING FUNCTIONS

The following annunciations and alerting functions are displayed on the PFD. Refer to Appendix A for more information on alerts and annunciations.

MARKER BEACON ANNUNCIATIONS

Marker Beacon Annunciations are displayed on the PFD to the left of the Selected Altitude. Outer marker reception is indicated in cyan, middle in amber, and inner in white. Refer to the Audio Panel and CNS Section for more information on Marker Beacon Annunciations.

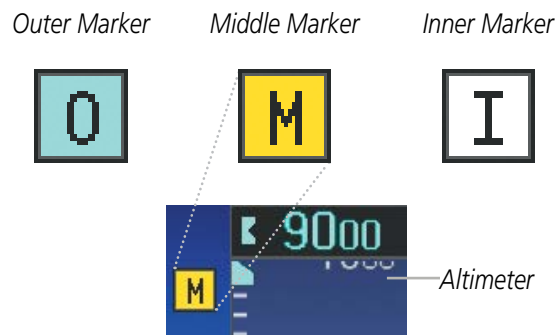

Figure 2-33 Marker Beacon Annunciations

BARO TRANSITION ALERT

A Baro Transition Alert is provided to alert the pilot to change the barometric pressure setting when crossing the transition altitude (in either direction). This is displayed by the barometric pressure setting flashing light blue when crossing the transition altitude. The flashing stops when the barometric pressure setting is changed.

Setting the Baro Transition Alert:

- 1) Use the **FMS** Knob to select the 'AUX - System Setup' Page.
- 2) Push the **FMS** Knob to activate the cursor.
- 3) Turn the large **FMS** Knob to highlight ON or OFF in the Baro Transition Alert box.
- 4) Turn the small **FMS** Knob to turn the alert OFF or ON and press the **ENT** Key.
- 5) With the altitude field highlighted, turn the small **FMS** Knob to set desired altitude and press the **ENT** Key.
- 6) To cancel the selection, push the **FMS** Knob.

- SYSTEM OVERVIEW
- FLIGHT INSTRUMENTS
- EIS
- AUDIO PANEL & CNS
- FLIGHT MANAGEMENT
- HAZARD AVOIDANCE
- AFCS
- ADDITIONAL FEATURES
- APPENDICES
- INDEX

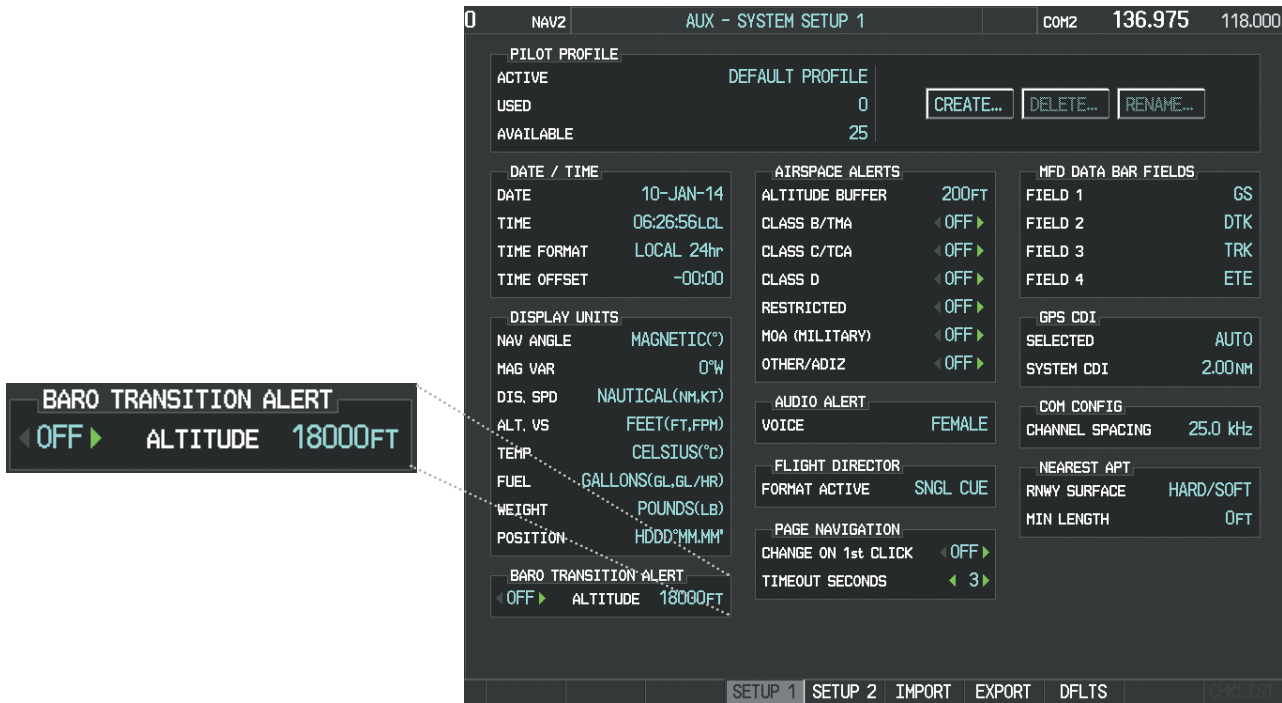

Figure 2-34 Baro Transition Alert ('AUX - System Setup' Page)

TRAFFIC ANNUNCIATION

The Perspective system displays traffic symbolically on the Inset Map (PFD), the 'MAP - Navigation Map' Page (MFD), and various other MFD page maps. Refer to the Hazard Avoidance Section for more details about the optional Traffic Advisory Systems (TAS). When a Traffic Advisory (TA) is detected, the following automatically occurs:

- The PFD Inset Map is enabled, displaying traffic
- A flashing black-on-amber TRAFFIC annunciation (Figure 2-35) appears to the top left of the Attitude Indicator for 5 seconds and remains displayed until no TAs are detected in the area
- An aural traffic alert may be generated. Refer to the applicable traffic advisory system (TAS) documentation for alerts generated by TAS equipment.

If additional TAs appear, new aural and visual alerts are generated.



Figure 2-35 Traffic Annunciation

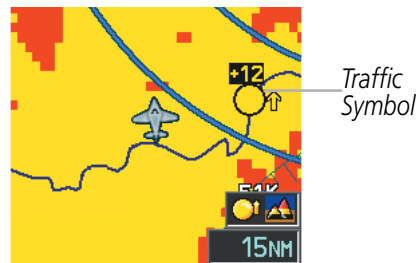

Figure 2-36 Inset Map with Traffic Displayed

TERRAIN ANNUNCIATIONS

Terrain Awareness and Warning System (TAWS) or Terrain-SVT annunciations appear on the PFD to the left of the Altimeter (also where the marker beacon annunciations appear). Refer to the Hazard Avoidance Section and Appendix for information on terrain alerts and annunciations.



Figure 2-37 TAWS Annunciation on the PFD

ALTITUDE ALERTING

The Altitude Alerting function provides the pilot with visual and aural alerts when approaching the Selected Altitude. Whenever the Selected Altitude is changed, the Altitude Alerter is reset. The Altitude Alerter is independent of the Garmin AFCS. The following occur when approaching the Selected Altitude:

- Upon passing through 1000 feet of the Selected Altitude, the Selected Altitude (shown above the Altimeter) changes to black text on a cyan background and flashes for 5 seconds.
- When the aircraft passes within 200 ft of the Selected Altitude, the Selected Altitude changes to cyan text on a black background and flashes for 5 seconds and a single chime is heard.
- After reaching the Selected Altitude, if the pilot flies outside the deviation band (± 200 feet of the Selected Altitude), the Selected Altitude changes to amber text on a black background, flashes for 5 seconds, and the word “Altitude” is heard.



Figure 2-38 Altitude Alerting Visual Annunciations

LOW ALTITUDE ANNUNCIATION



NOTE: The Low Altitude Annunciation is available only for aircraft with GIA 63W Integrated Avionics Units when SBAS is available. This annunciation is not shown for systems with TAWS or Terrain-SVS, unless terrain alerting is inhibited.

When the Final Approach Fix (FAF) is the active waypoint in a GPS SBAS approach using vertical guidance, a Low Altitude Annunciation may appear if the current aircraft altitude is at least 164 feet below the prescribed altitude at the FAF. A black-on-amber 'LOW ALT' annunciation appears to the top right of the Altimeter, flashing for several seconds then remaining displayed until the condition is resolved.



Figure 2-39 Low Altitude on GPS SBAS Approach with TAWS Inhibited

MINIMUM ALTITUDE ALERTING

For altitude awareness, a minimum altitude alert based on barometric altitude or temperature compensated altitude can be set. When active, the altitude setting is displayed to the lower left of the altimeter and with a bug at the corresponding altitude along the altimeter (once the altitude is within the visible range of the tape). The following visual annunciations alert the pilot when approaching the set minimum:

- When the aircraft altitude descends to within 2500 feet of the minimum altitude alert setting, a box labeled 'BARO MIN' or 'COMP MIN' (based on the selected altitude source) appears with the altitude in cyan text (or magenta for TEMP COMP). The bug appears in cyan (or magenta for TEMP COMP) on the altitude tape at the corresponding altitude once in range.
- When the aircraft passes through 100 feet of the minimum altitude alert, the bug and text become white.
- Once the aircraft reaches the minimum altitude alert, the bug and text become amber.

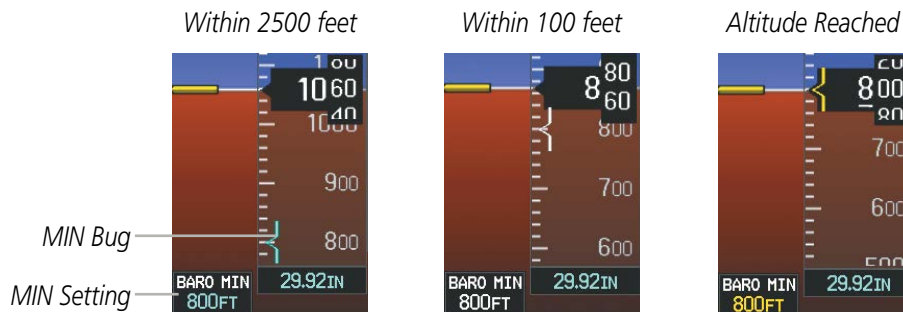

Figure 2-40 Minimum Altitude Alerting Visual Annunciations

Setting the minimum altitude alert and bug:

- 1) Press the **TMR/REF** Softkey.
- 2) Turn the large **FMS** Knob to highlight the Minimums field.
- 3) Turn the small **FMS** Knob to select the desired altitude source: barometric (BARO) or temperature compensated (TEMP COMP). OFF is selected by default. Press the **ENT** Key or turn the large **FMS** Knob to highlight the next field.
- 4) Use the small **FMS** Knob to enter the desired altitude (from zero to 16,000 feet).
- 5) To remove the window, press the **CLR** Key or press the **TMR/REF** Softkey.



Figure 2-41 BARO and TEMP COMP Altitude Alerting

2.4 ABNORMAL OPERATIONS

ABNORMAL GPS CONDITIONS

The annunciations listed in Table 2-3 can appear on the HSI when abnormal GPS conditions occur; see the figure for examples. Refer to the Flight Management Section for more information on Dead Reckoning Mode.

Annunciation	Location	Description
LOI	Lower left of aircraft symbol	Loss of Integrity Monitoring—GPS integrity is insufficient for the current phase of flight
INTEG OK	Lower left of aircraft symbol	Integrity OK—GPS integrity has been restored to within normal limits (annunciation displayed for 5 seconds)
DR	Upper right of aircraft symbol	Dead Reckoning—System is using projected position rather than GPS position to compute navigation data and sequence active flight plan waypoints

Table 2-3 Abnormal GPS Conditions Annunciated on HSI



Figure 2-42 Example HSI Annunciations

As a result of operating in DR Mode, all GPS-derived data is computed based upon an estimated position and is displayed in amber on the display to denote degraded navigation source information. This data includes the following:

- Navigation Status Box fields except Active Leg, TAS, and DTK
- Course Deviation Indicator (removed after 20 minutes)
- GPS Bearing Pointer
- Wind data and pointers in the Wind Data Box on the PFD
- Track Indicator
- All Bearing Pointer Distances
- Active Flight Plan distances, bearings, and ETE values

Also, while the Perspective system is in DR Mode, the autopilot will not couple to GPS, and terrain alerting (if installed) is disabled. Additionally, the accuracy of all nearest information (airports, airspace, and waypoints) is questionable. Finally, airspace alerts continue to function, but with degraded accuracy.

SYSTEM OVERVIEW
FLIGHT INSTRUMENTS
EIS
AUDIO PANEL & CNS
FLIGHT MANAGEMENT
HAZARD AVOIDANCE
AFCS
ADDITIONAL FEATURES
APPENDICES
INDEX

HEADING FAILURE MODES

If the system is unable to determine the aircraft heading, but GPS-based track information is available, the HSI displays the ground track instead of heading using HSI Track Mode. In this mode, a magenta 'TRK' annunciation and track readout appear on the HSI. In addition, an amber 'HDG' annunciation with a red X appear above the 'TRK' annunciation to indicate the HSI is displaying track instead of heading.

If both the heading and track are unavailable, the HSI displays an amber 'HDG' annunciation with a red X over the heading readout box. The system also removes directional numbers and letters from the HSI.



HSI Track Mode (Heading Unavailable, Track Available)



Heading and Track Unavailable

Figure 2-43 Heading Failure Displays on the HSI

UNUSUAL ATTITUDES

When the aircraft enters an unusual pitch attitude, red extreme pitch warning chevrons pointing toward the horizon are displayed on the Attitude Indicator, starting at 50° above and 30° below the horizon line.

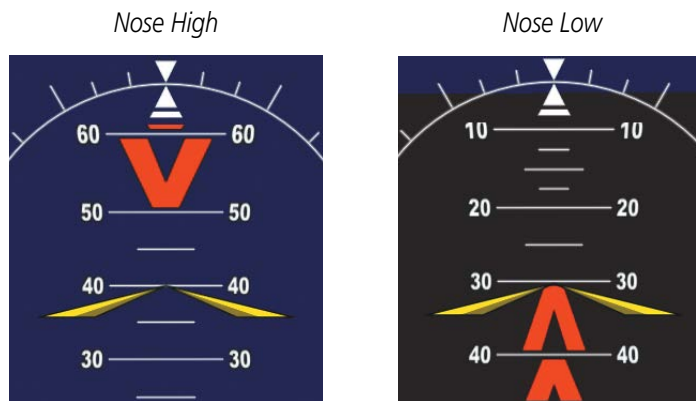

Figure 2-44 Pitch Attitude Warnings

If pitch exceeds +30°/-20° or bank exceeds 65°, some information displayed on the PFD is removed. The Altimeter and Airspeed, Attitude, Vertical Speed, and Horizontal Situation indicators remain on the display and the Bearing Information, Alerts, and Annunciation windows can be displayed during such situations. The following information is removed from the PFD (and corresponding softkeys are disabled) when the aircraft experiences unusual attitudes:

- Traffic Annunciations
- AFCS Annunciations
- Flight director Command Bars
- Inset Map
- True Airspeed
- Ground Speed
- Outside Air Temperature
- DME Information Window
- Wind Data
- Selected Heading Box
- Selected Course Box
- Transponder Status Box
- System Time
- PFD Setup Menu
- Minimum Descent Altitude/ Decision Height readout
- Vertical Deviation, Glideslope, and Glidepath Indicators
- Altimeter Barometric Setting
- Selected Altitude
- VNV Target Altitude
- Windows displayed in the lower right corner of the PFD:
 - Timer/References
 - Nearest Airports
 - Flight Plan
 - Alerts
 - Procedures
 - DME Tuning

SECTION 3 ENGINE INDICATION SYSTEM

The Engine Indication System (EIS) displays critical engine, electrical, fuel, optional ice protection, and other system parameters on the left side of the Multi Function Display (MFD) during normal operations (Figure 3-1). EIS information can be fully expanded to an entire page ('EIS - Engine' Page) using the **ENGINE** Softkey. In Reversionary Mode, the display-combines Primary Flight Display (PFD) symbology with the EIS.



Figure 3-1 MFD (SR20)

Green bands on the instruments indicate normal ranges of operation; amber and red bands indicate caution and warning, respectively. White or uncolored bands indicate areas outside of normal operation. When unsafe operating conditions occur, the corresponding displays, pointers and labels change color corresponding to the level of the condition; warnings also flash (except fuel at destination). If sensory data to an instrument becomes invalid or unavailable, a red 'X' is displayed across the instrument. However, the numeric displays in the Fuel Calculation Box, TKS FIKI Anti Ice Box (optional), and the density altitude in the Air Data Box are replaced with dashes instead of red 'X's when the data is invalid or out of range.

3.1 EIS DISPLAY

NOTE: Refer to the current version of the pertinent flight manual for engine operating limitations.

NOTE: Depictions of equipment may differ from the installed equipment. Examples shown may differ from actual aircraft configurations.

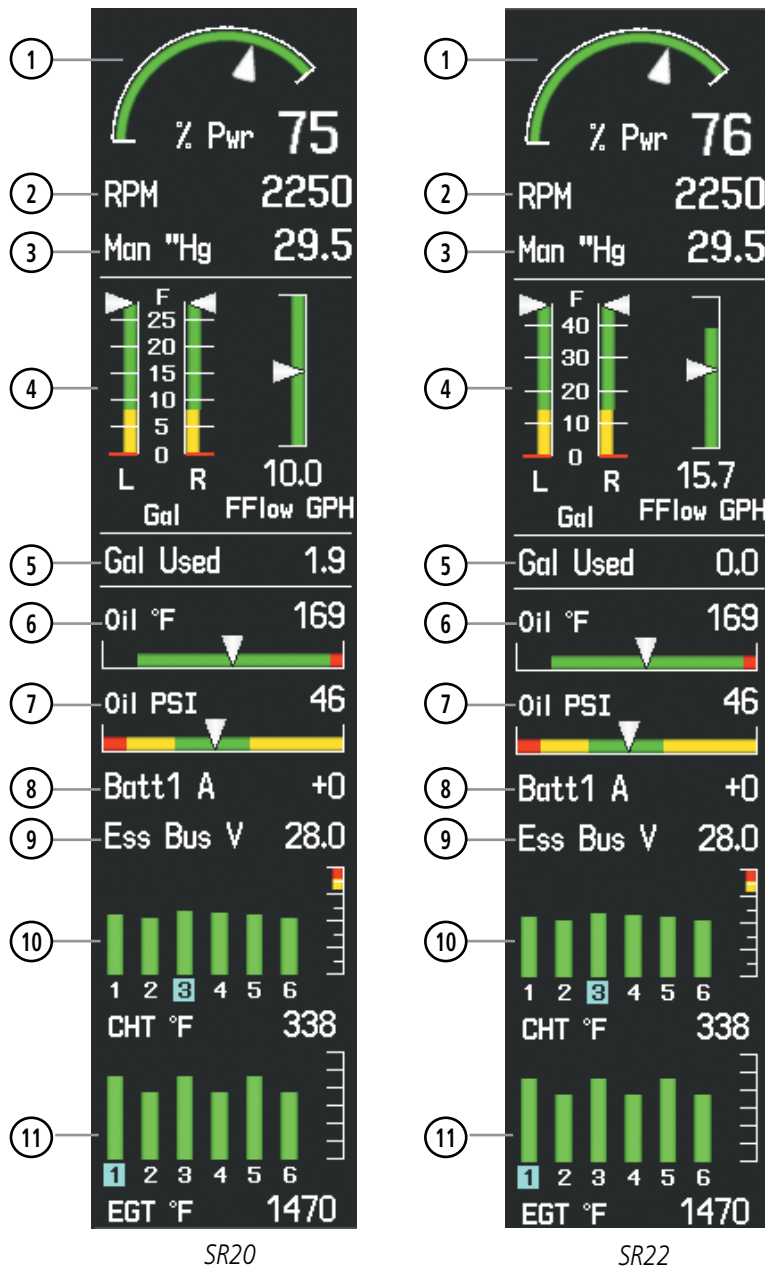

Figure 3-2 EIS Display (Naturally Aspirated)

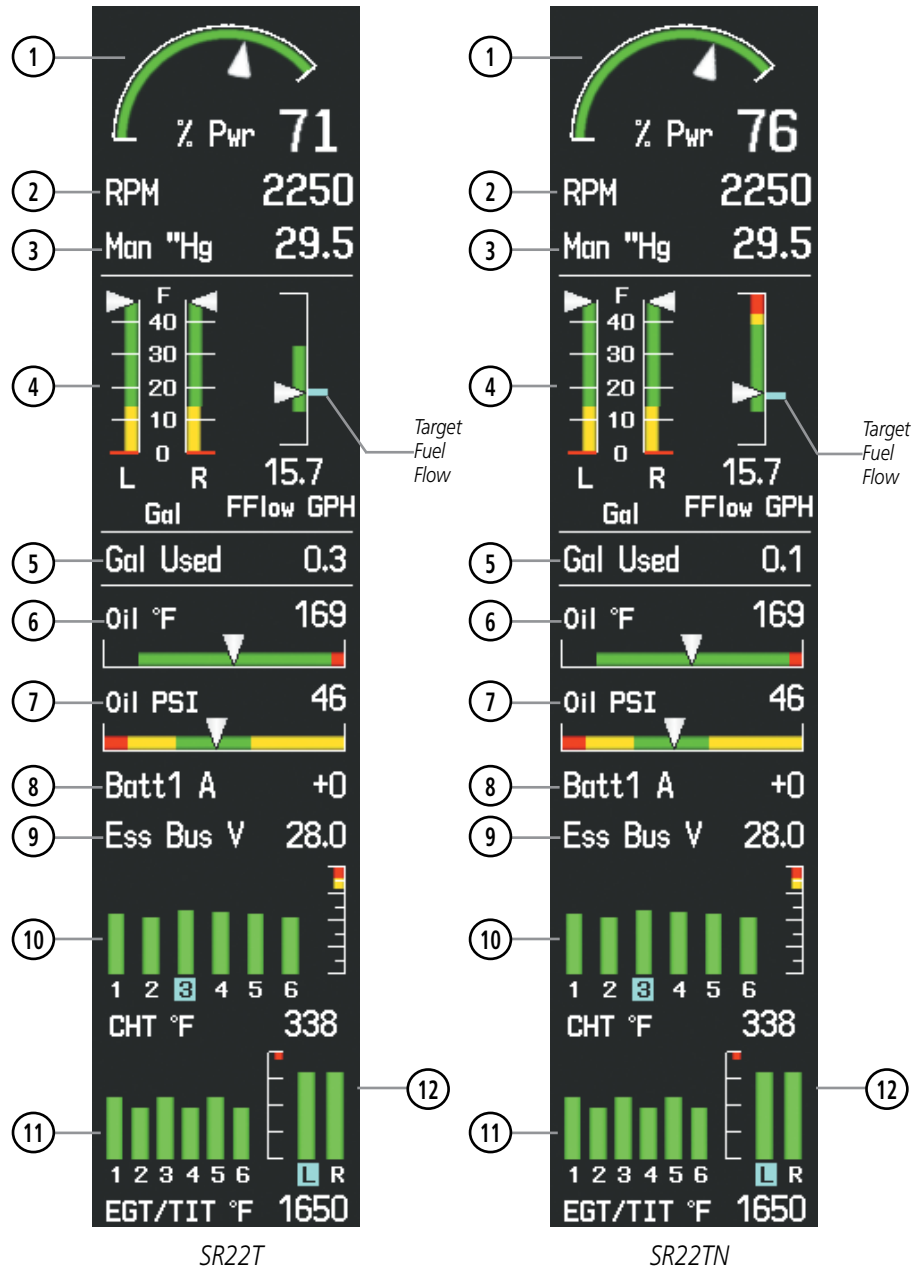

Figure 3-3 EIS Display (Turbo)

- | | | |
|---|---|--|
| ① | Percent Power Indicator (% Pwr) | Displays engine power as a percentage |
| ② | Tachometer (RPM) | Displays propeller speed in revolutions per minute |
| ③ | Engine Manifold Pressure Indicator (Man “Hg) | Displays manifold pressure in inches of Mercury to indicate engine power |
| ④ | Fuel Quantity Indicator (GAL)
&
Fuel Flow Indicator (FFlow GPH) | Displays fuel quantities, in gallons, for the left (L) and right (R) fuel tanks.

Displays fuel flow in gallons per hour (<i>Turbo models only – displays a cyan target fuel flow indicator to the right of the fuel flow indicator strip</i>) |
| ⑤ | Gallons Used Indicator (Gal Used) | Displays the fuel used in gallons |
| ⑥ | Oil Temperature Indicator (Oil °F) | Displays engine oil temperature in degrees Fahrenheit |
| ⑦ | Oil Pressure Indicator (Oil PSI) | Displays pressure of oil supplied to the engine in pounds per square inch (psi) |
| ⑧ | Ammeter (Batt1 A) | Displays the battery 1 load in amperes |
| ⑨ | Voltmeter (ESS Bus V) | Displays the essential bus voltage in volts |
| ⑩ | Cylinder Head Temperature Indicator (CHT °F) | Displays the head temperature of the hottest cylinder (CHT; cylinder number is shown below bar) |
| ⑪ | Exhaust Gas Temperature Indicator (EGT °F)
Exhaust Gas Temperature/ Turbine Inlet Temperature Indicator (EGT/TIT °F) | Displays the exhaust gas temperature (cylinder number is shown below bar) (<i>naturally aspirated models only</i>)
Displays the exhaust gas temperature and turbine inlet temperature (cylinder number or turbine inlet side is shown below bar) (<i>Turbo models only</i>) |
| ⑫ | Left and Right Turbine Inlet Temperature | Displays the temperature at the left (L) and right (R) turbine inlet (<i>Turbo models only</i>) |

3.2 ENGINE PAGE

Pressing the **ENGINE** Softkey accesses the 'EIS - Engine' Page, which displays all engine, fuel, fuel calculation, electrical, air data, and optional ice protection information. Pressing the optional **ANTI-ICE** Softkey accesses the second-level softkeys. Pressing the **FUEL** Softkey accesses the second-level softkeys.

NOTE: The ice protection system (optional) must be operated in accordance with the approved flight manual limitations. This option is only available on SR22 and SR22T models.

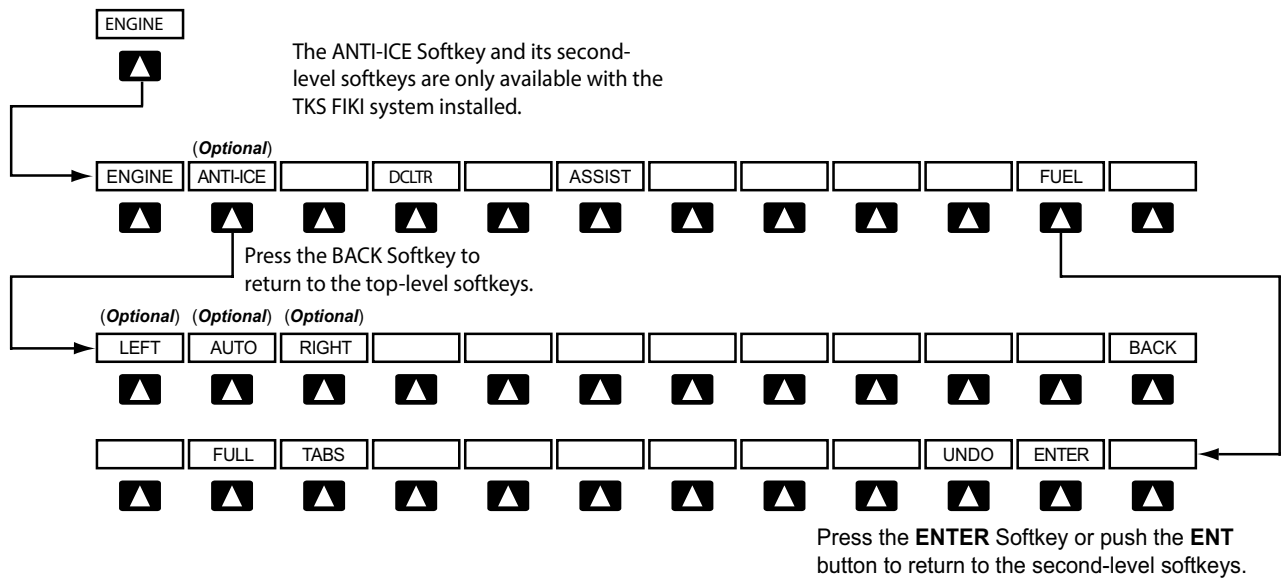

Figure 3-4 Engine Page Softkeys

Level 1	Level 2	Level 3	Description
ENGINE			Displays full Engine Page and second-level engine softkeys; press again to return to the Engine Strip and top-level softkeys (see the EIS Section for more information)
	ANTI-ICE		Displays Anti-Ice softkeys (optional -TKS FIKI only; See Operational Note above)
		LEFT	Selects manual mode and opens the left tank valve and closes the right tank valve
		AUTO	Selects auto tank selection mode
		RIGHT	Selects manual mode and opens the right tank valve and closes the left tank valve
	DCLTR		Removes bars and temperature displays from the Engine Temperature Box
	ASSIST		Identifies temperature peaks
	FUEL		
		FULL	Accesses the Initial Usable Fuel Page
		TABS	Resets fuel totalizer to tabs (usable fuel)
		UNDO	Resets to the initial usable fuel amount shown on the Initial Usable Fuel Page
		ENTER	Saves the usable fuel amount as displayed on the Initial Usable Fuel Page

NOTE: Refer to the current version of the pertinent flight manual for engine operating limitations.

NOTE: The ice protection system (optional) must be operated in accordance with the approved flight manual limitations. This option is only available on SR22 and SR22T models.

NOTE: Depictions of equipment may differ from the installed equipment. Examples shown may not represent all possible aircraft configurations.



Figure 3-5 Engine Page (SR20)



Figure 3-6 Engine Page (SR22) with TKS NH Anti-Ice Option



Figure 3-7 Engine Page (SR22T) with TKS FIKI and Oxygen



Figure 3-8 Engine Page (SR22TN) with Oxygen

- | | | |
|---------------------|--|--|
| SYSTEM OVERVIEW | ① Percent Power Indicator (% Pwr) | Displays engine power as a percentage |
| FLIGHT INSTRUMENTS | ② Tachometer (RPM x100) | Displays propeller speed in revolutions per minute |
| EIS | ③ Engine Manifold Pressure Indicator (Man “Hg) | Displays manifold pressure in inches of Mercury to indicate engine power |
| AUDIO PANEL & CNS | ④ Fuel Flow Indicator (FFlow GPH) | Displays fuel flow in gallons per hour (<i>SR22T models only – displays a cyan target fuel flow indicator shown on top of the fuel flow gauge</i>) |
| FLIGHT MANAGEMENT | ⑤ Oil Temperature and Pressure Indicators (Oil °F PSI) | Displays oil temperature in degrees Fahrenheit (°F) and pressure in pounds per square inch (psi) |
| HAZARD AVOIDANCE | ⑥ Electrical Group (Electrical) | Displays the alternator and battery current in amperes and the essential and main bus voltage |
| AFCS | ⑦ Fuel Calculation Group (Fuel Calculation) | Displays calculated fuel at destination, fuel used, fuel remaining, time remaining, range (in nautical miles) and economy (in nautical miles per gallon) based on the displayed fuel remaining and the fuel flow totalizer |
| ADDITIONAL FEATURES | ⑧ Fuel Quantity Indicator | Displays fuel quantities, in gallons, for the left (L) and right (R) fuel tanks |
| APPENDICES | ⑨ Air Data | Displays density altitude, outside air temperature (OAT) in °F and °C, and international standard atmosphere (ISA) temperature deviation |
| INDEX | ⑩ Oxygen Pressure Indicator | Displays oxygen pressure in tank in pounds per square inch (<i>optional</i>) |
| | ⑪ Anti-Ice Fluid Quantity Indicator (TKS NH and TKS FIKI) | TKS NH – Displays the quantity of anti-ice fluid remaining in the single tank (<i>optional – See Operational Note below</i>)
TKS FIKI – Displays the quantity of anti-ice fluid remaining in the left (L) and right (R) tanks in gallons (<i>optional – See Operational Note below</i>) |
| | ⑫ Engine Temperature Group (Engine Temperature) | Displays head (CHT) and exhaust gas temperatures (EGT) of all cylinders in °F (<i>all models</i>) and turbine inlet temperatures (<i>turbo models only</i>) |

FUEL CALCULATIONS

NOTE: Fuel calculations do not use the aircraft fuel quantity indicators and are calculated from the last time the fuel was reset.

Fuel used (Used), time remaining (Time Rem), range (in nautical miles, Range), and economy (Econ) are calculated based on the displayed fuel remaining (Rem) and the fuel flow totalizer. The calculated range is based upon ground speed, distance, economy and fuel remaining. See the Flight Management Section for information regarding the map feature related to the EIS Fuel Calculations.

Adjusting the fuel totalizer quantity:

- 1) Press the **ENGINE** Softkey to display the Engine Page.
- 2) Press the **FUEL** Softkey to access the Initial Usable Fuel Page.
- 3) Turn the **FMS** Knob (small knob adjusts in 1 gallon increments and large knob in 10 gallon increments) to increase or decrease the initial usable fuel displayed.

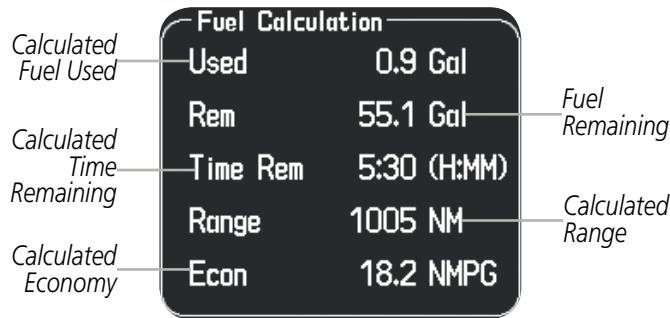

Figure 3-9 Fuel Calculations Group

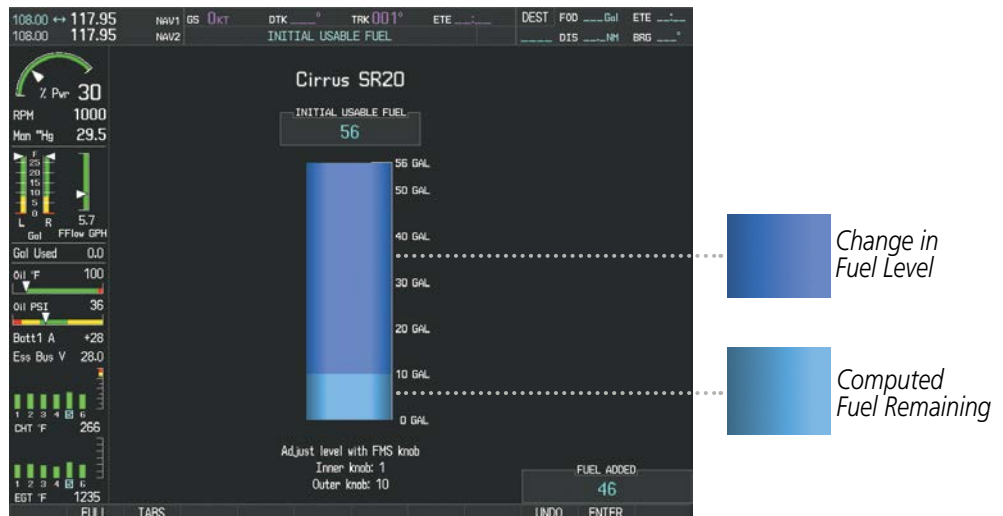

Figure 3-10 Full Fuel (SR20) Initial Usable Fuel Page

- SYSTEM OVERVIEW
- FLIGHT INSTRUMENTS
- EIS
- AUDIO PANEL & CNS
- FLIGHT MANAGEMENT
- HAZARD AVOIDANCE
- AFCS
- ADDITIONAL FEATURES
- APPENDICES
- INDEX



Change in Fuel Level

Computed Fuel Remaining

Figure 3-11 Fuel to TABS (SR22) Initial Usable Fuel Page



Change in Fuel Level

Computed Fuel Remaining

Figure 3-12 Full Fuel (SR22) Initial Usable Fuel Page

ICE PROTECTION SYSTEMS

The Perspective® System interfaces with either of two optional ice protection systems, TKS No-Hazard (NH) or TKS Flight Into Known Icing (FIKI) anti-ice systems. Refer to the applicable the current version of the pertinent flight manual for a detailed system description of the installed ice protection system.

NOTE: *The ice protection system (optional) must be operated in accordance with the approved flight manual limitations. This option is only available on SR22 and SR22T models.*

The TKS NH system displays a single quantity gauge on the 'EIS-Engine' Page to indicate the amount of anti-ice fluid available.



Figure 3-13 TKS NH System Fluid Quantity Gauge

TKS FLIGHT INTO KNOWN ICING (FIKI) ANTI-ICE SYSTEM

The FIKI system offers five pilot-selectable (external to the Perspective® System) modes of operation and a more sophisticated quantity indicator located on the full Engine Page. To accommodate the additional modes, the TKS FIKI system employs several additional sensors. The Perspective® System receives inputs from these sensors and provides indications as to the status of the TKS FIKI system.

AUTO TANK SELECTION MODE

In the default tank selection mode (AUTO), Perspective® assures that the fluid levels of the two tanks are kept relatively even by periodically closing the tank with the lowest level. The system uses the anti-ice fluid tank quantities to control the tank shut-off valves. When the system is on and operating in AUTO mode, the shut-off valves close under the following conditions:

- The fluid quantity is empty (indicated from the fluid level sensor and level switch)
- The left and right tank level imbalance is greater than 0.25 gallons (low tank will be closed until level balance is within 0.15 gallons)
- The fluid quantity is unreliable (a miscompare between the level sensor and level switch or an out of range level sensor value)

While operating in AUTO mode a white box is displayed around the 'L' and 'R', located on top of each fluid quantity indicator, when both tanks are open. During normal operation, the white box will highlight the left or right tanks as the fluid levels change (Figure 3-14).

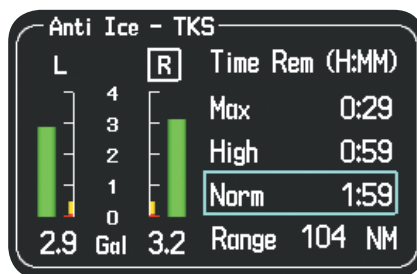

Figure 3-14 AUTO Tank Mode (Normal)

If a fluid level comparison fault is detected (the fluid level sender disagrees with the fluid level switch for a particular tank) the corresponding fluid quantity indicator is grayed out (Figure 3-15) and that quantity is not used in the endurance and range calculations. When the fluid level sender is out of range, the fluid quantity indicator is marked with a red 'X' (Figure 3-16).

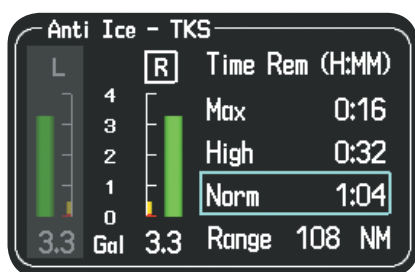

Figure 3-15 Fluid Level Unreliable

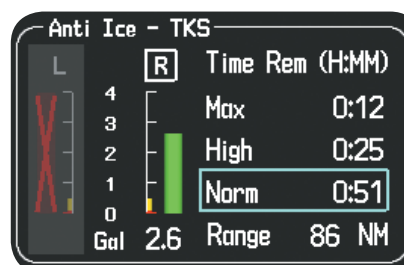

Figure 3-16 Fluid Level Out Of Range

MANUAL TANK MODE

Manual tank mode allows the pilot to control either tank's shut-off valve. Manual may be selected by pressing the **ANTI-ICE** Softkey to access the second-level softkeys **LEFT**, **AUTO**, and **RIGHT**. A cyan box is displayed around the selected tank, gallons remaining in the selected tank, and pump operating mode.

- **LEFT** Softkey – opens left tank valve and closes right tank valve
- **AUTO** Softkey – returns to AUTO tank mode
- **RIGHT** Softkey – opens right tank valve and closes left tank valve

While operating in manual tank mode, only the selected/open tank's quantity is used for the range and endurance calculations.

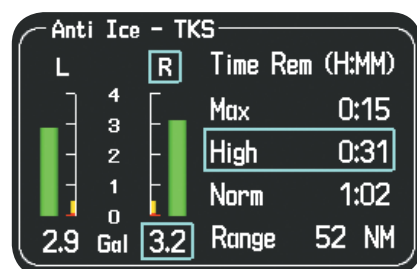

Figure 3-17 Manual Tank Mode (Left tank selected)

PUMP OPERATING MODES

The Ice Protection systems consists of various pump operating modes listed below.



NOTE: The ice protection system (optional) must be operated in accordance with the approved flight manual limitations. This option is only available on SR22 and SR22T models.

Operating Mode	System Operation	Comments
OFF	System Off	No modes selected
NORM	Both pumps operate on a timed, repeating cycle – 30 seconds ON and 90 seconds OFF	Provides 50% flow rate for light/moderate icing ☁
HIGH	A single pump (#1) operates continuously	Provides 100% flow rate for moderate icing ☁
MAX (momentary)	Both pumps operate continuously for 120 seconds	Provides 200% flow rate for severe icing or to expedite the removal of previous ice buildup ☁
PUMP BKUP	A single pump (#2) operates continuously	This mode is used in the event of a timer box failure or when BKUP mode is selected. Pump #2 provides 100% flow rate, bypassing the timer box ☁

☁ Refer to the current version of the pertinent flight manual for pilot recommended actions

Table 3-1 FIKI System Operating Modes

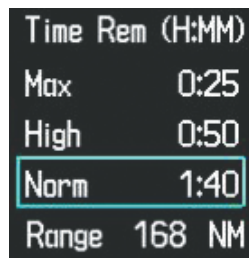

Figure 3-18 Normal Operating Mode

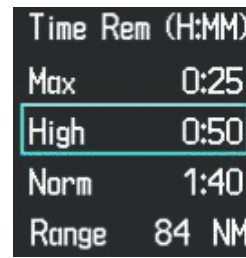

Figure 3-19 High Operating Mode

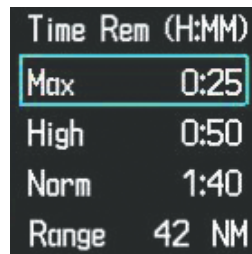

Figure 3-20 Max Operating Mode

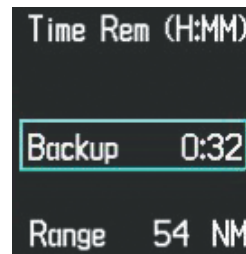

Figure 3-21 Pump Backup Mode

3.3 LEANING ASSIST MODE



NOTE: The pilot should follow the engine manufacturer's recommended leaning procedures in the current version of the pertinent flight manual.

A leaning assist function is available on the Engine Page to assist in the leaning process.

Accessing Leaning Assist Mode:

- 1) Press the **ENGINE** Softkey to display the Engine Page.
- 2) Press the **ASSIST** Softkey to identify peaks.

When the **ASSIST** Softkey is pressed, the system initially highlights the number and places a cyan box around the EGT display of the cylinder with the hottest EGT. The Δ Peak temperature is the difference between the peak temperature and the present temperature for the peaked cylinder. When the first peak is detected, "1st" is annunciated below that cylinder's EGT bar and the temperature is enclosed in a cyan box.

The system continues to detect peak EGTs for each cylinder lean of peak as the fuel flow is decreased, and the peak of each cylinder's EGT is indicated by a cyan marker on the graph. Once all cylinders are lean of peak, the last cylinder to peak is denoted by the "Last" annunciation below its bar on the graph.

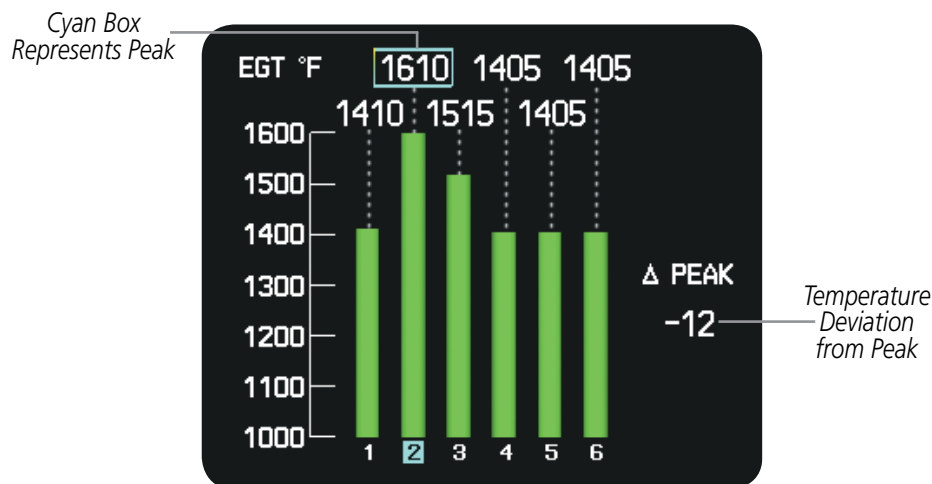

Figure 3-22 Leaning Assist Mode

3.4 EIS DISPLAY IN REVERSIONARY MODE

In reversionary mode, the display combines PFD symbology with the EIS Display (refer to the System Overview for information about display Reversionary Mode).

In reversionary mode, the EIS is separated into two displays: Engine (identical to the normal EIS Display on the MFD) and System. For a description of the EIS Display, refer to Section 3.1. The System Display shows various system parameters and fuel calculations.



Figure 3-23 Reversionary Mode (SR22)

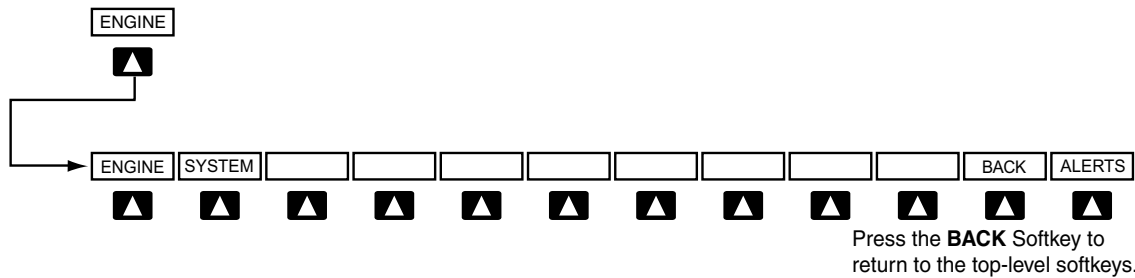

Figure 3-24 EIS Softkeys (Reversionary Mode)

SYSTEM DISPLAY

NOTE: Fuel calculations do not use the aircraft fuel quantity indicators and are calculated anytime the initial usable fuel is changed.

NOTE: Refer to the current version of the pertinent flight manual for limitations.

The EIS System Display shows the engine, fuel calculations, electrical, and various system parameters. Fuel calculations are based on the displayed fuel remaining and the fuel flow totalizer.

Accessing the EIS System Display:

- 1) Press the **ENGINE** Softkey.
- 2) Press the **SYSTEM** Softkey.
- 3) To return to the default Engine Display, press the **ENGINE** or **BACK** Softkey.



SR20

SR22 Models with optional Anti-Ice and Oxygen

Figure 3-25 System Display

- | | | |
|---|---|--|
| ① | Percent Power Indicator
(% Pwr) | Displays engine power as a percentage |
| ② | Tachometer (RPM) | Shows propeller speed in revolutions per minute |
| ③ | Engine Manifold Pressure Indicator (Man “Hg) | Displays manifold pressure in inches of Mercury to indicate engine power |
| ④ | Fuel Calculation Group (Fuel Calc) | Displays calculated fuel at destination, fuel used, fuel remaining, time remaining, range (in nautical miles) and economy (in nautical miles per gallon) based on the displayed fuel remaining and the fuel flow totalizer |
| ⑤ | Electrical Group (Electrical) | Displays the alternator and battery current in amperes and the essential and main bus voltage |
| ⑥ | Miscellaneous (Misc) | Displays engine hours and anti-ice gallons (<i>optional</i>) and oxygen pressure (<i>optional</i>) |

SYSTEM
OVERVIEW

FLIGHT
INSTRUMENTS

EIS

AUDIO PANEL
& CNS

FLIGHT
MANAGEMENT

HAZARD
AVOIDANCE

AFCS

ADDITIONAL
FEATURES

APPENDICES

INDEX

BLANK PAGE

SECTION 4 AUDIO PANEL AND CNS

4.1 OVERVIEW

The Communication/Navigation/Surveillance (CNS) system includes the Audio Panel, communication radios, navigation radios, and Mode A/C or Mode S transponder. The System Overview Section provides a block diagram description of the Audio Panels and CNS system interconnection.

CNS operation in the avionics system is performed by the following Line Replaceable Units (LRUs):

- Primary Flight Display (PFD)
- Multifunction Display (MFD)
- Integrated Avionics Unit (2)
- Audio Panel
- Mode A/C or Mode S Transponder
- Control Unit

The MFD/PFD controls are used to tune the communication transceivers and navigation radios.

The Audio Panel provides the traditional audio selector functions of microphone and receiver audio selection. The Audio Panel includes an intercom system (ICS) between the pilot, copilot, and passengers, a marker beacon system, and a COM clearance recorder. Ambient noise from the aircraft radios is reduced by a feature called Master Avionics Squelch (MASQ). When no audio is detected, MASQ processing further reduces the amount of background noise from the radios.

The Mode S or Mode A/C transponder is controlled with softkeys and the **FMS** Knob located on the Primary Flight Display (PFD) and also the Control Unit. The Transponder Data Box is located to the left of the System Time Box. The data box displays the active four-digit code, mode, and a reply status (Figures 4-1 and 4-2).

MFD/PFD CONTROLS AND FREQUENCY DISPLAY



Figure 4-1 PFD Controls, COM Frequency Tuning Boxes, Transponder Code, and DME Tuning Window

- ① **COM Frequency Box** – Displays COM standby and active frequency fields and volume. The selected COM transceiver frequency is displayed in green.
- ② **COM Knob** – Tunes the standby frequencies for the COM transceiver (large knob for MHz; small knob for kHz). Press to move the tuning box (light blue box) and Frequency Transfer Arrow between COM1 and COM2.
- ③ **COM Frequency Transfer Key** – Transfers the standby and active COM frequencies. Press and hold this key for two seconds to tune the emergency frequency (121.500 MHz) automatically into the active frequency field.
- ④ **COM VOL/SQ Knob** – Controls COM audio volume level. Press to turn the COM automatic squelch on and off. Volume level is shown in the COM frequency field as a percentage.
- ⑤ **DME Tuning Window** – Displays DME frequency pairing mode. Display by pressing the **DME** Softkey.
- ⑥ **ENT Key** – Validates or confirms DME pairing mode and Auto-tune selection.



Figure 4-2 MFD Controls and NAV Frequency Tuning Boxes

- ⑦ **FMS Knob** – Flight Management System Knob, used to enter transponder codes, select DME modes, and Auto-tune entries when DME Tuning Window or NRST Window is present. Push the **FMS** Knob to turn the selection cursor on and off. The large knob moves the cursor in the window. The small knob selects individual characters for the highlighted cursor location.
- ⑧ **Transponder Data Box** – Indicates the selected transponder code, operating mode, reply, and ident status for the applicable transponder.
- ⑨ **NAV VOL/ID Knob** – Controls NAV audio volume level. Press to turn the Morse code identifier audio on and off. Volume level is shown in the NAV frequency field as a percentage.
- ⑩ **NAV Frequency Transfer Key** – Transfers the standby and active NAV frequencies.
- ⑪ **NAV Knob** – Tunes the standby frequencies for the NAV receiver (large knob for MHz; small knob for kHz). Press to move the tuning box (light blue box) and Frequency Transfer Arrow between NAV1 and NAV2.
- ⑫ **NAV Frequency Box** – Displays NAV standby and active frequency fields, volume, and station ID. The frequency of the NAV radio selected for navigation is displayed in green.

GMA 350/350C AUDIO PANEL CONTROLS

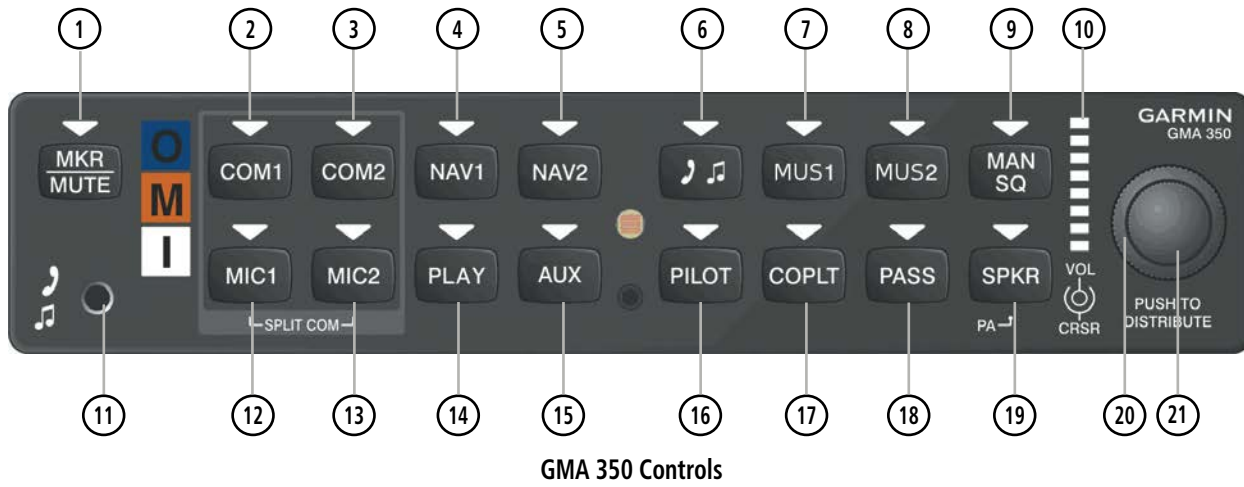

GMA 350 Controls

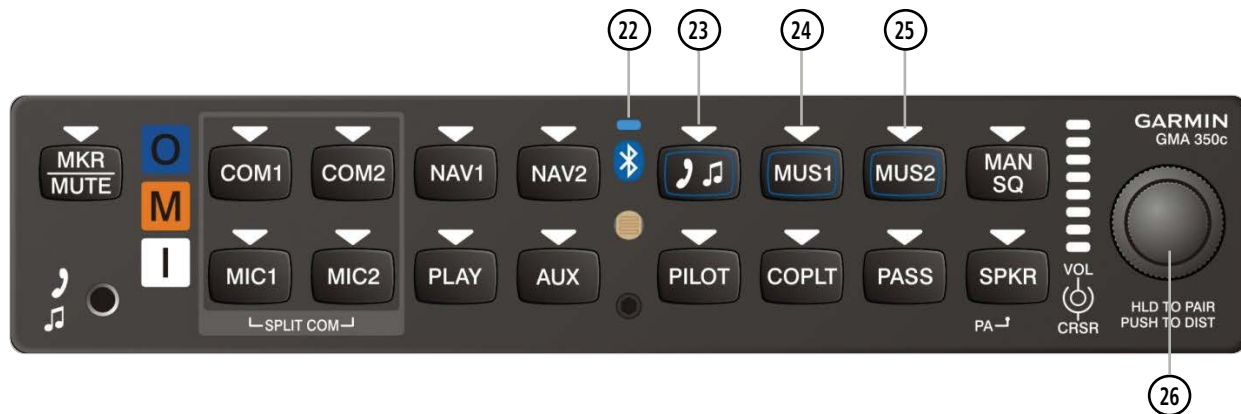



GMA 350c (Bluetooth) Controls

Figure 4-3 GMA 350/350c Audio Panel Controls



NOTE: When a key is selected, a triangular annunciator above the key is illuminated.

- ① **MKR/MUTE** – Selects marker beacon receiver audio. Mutes the currently received marker beacon receiver audio. Deactivates automatically and marker beacon audio is heard when the next marker beacon signal is received. Also, stops play of recorded COM audio.
- ② **COM1** – When selected, audio from the #1 COM receiver can be heard. Press and hold to enable/disable monitored COM muting during primary COM reception.
- ③ **COM2** – When selected, audio from the #2 COM receiver can be heard. Press and hold to enable/disable monitored COM muting during primary COM reception.
- ④ **NAV1** – When selected, audio from the #1 NAV receiver can be heard.
- ⑤ **NAV2** – When selected, audio from the #2 NAV receiver can be heard.

- ⑥  – Selects and deselects audio from a telephone or entertainment device connected to the Front Panel Jack. Audio from a telephone connected to the rear of the audio panel is used if a device is not connected to the Front Panel Jack. Press and hold to enable/disable  muting during reception.
- ⑦ **MUS1** – Selects and deselects music entertainment audio. Press and hold to enable/disable **MUS1** muting during reception.
- ⑧ **MUS2** – Selects and deselects music entertainment audio. Press and hold to enable/disable **MUS2** muting during reception.
- ⑨ **MAN SQ** – Manual Squelch annunciator. When lit, squelch is controlled manually.
- ⑩ **Volume Indicator** – Indicates volume/squelch setting relative to full scale.
- ⑪ **Front Panel Jack** – Used for an entertainment or telephone input.
- ⑫ **MIC1** – Selects the #1 transmitter for transmitting. COM1 receive is simultaneously selected when this key is pressed allowing received audio from the #1 COM receiver to be heard. COM2 receive can be added by pressing the **COM2** Key. Selection of a second MIC button initiates Split-COM mode. When in Split-COM mode, the pilot is using COM1 and hears only COM1, the copilot is using COM2 and hears only COM2.
- ⑬ **MIC2** – Selects the #2 transmitter for transmitting. COM2 receive is simultaneously selected when this key is pressed allowing received audio from the #2 COM receiver to be heard. COM1 receive can be added by pressing the **COM1** Key. Selection of a second MIC button initiates Split-COM mode. When in Split-COM mode, the pilot is using COM1 and hears only COM1, the copilot is using COM2 and hears only COM2.
- ⑭ **PLAY** – Press once to play the latest recorded memory block. Press while audio is playing begins playing the previously recorded memory block. Each subsequent press thereafter plays the previous block of memory.
- ⑮ **AUX** – When selected, audio from the ADF and DME (if equipped) can be heard.
- ⑯ **PILOT** – Controls the pilot intercom system. Press and hold to toggle 3D Audio on/off for all headset positions.
- ⑰ **COPLT** – Controls the copilot intercom system. Press and hold to toggle copilot configuration between crew and passenger.
- ⑱ **PASS** – Controls the passenger intercom system. Press and hold to enable/disable passenger muting during reception.
- ⑲ **SPKR** – Selects and deselects the cabin speaker. COM, NAV, AUX, and MKR receiver audio can be heard on the speaker. Press and hold for 2 seconds for Passenger Address (PA). The **SPKR** key flashes during PA.
- ⑳ **Cursor (CRSR) Control Knob** – Turn to move the cursor (flashing white or blue annunciator) to the desired source.
- ㉑ **Volume (VOL) Control Knob** – Turn the smaller knob to control volume or squelch of the selected source (indicated by the flashing white or blue annunciator). When the volume control cursor is not active press to switch to Blue-Select mode. If the volume control cursor is active, press twice (once to cancel the cursor, twice to activate Blue-Select mode).

- 22 **Bluetooth® Connection Annunciator** – (GMA 350c only) A flashing blue annunciator indicates the unit is discoverable. A solid blue annunciator indicates an active Bluetooth connection.
- 23 **Key Annunciator** – (GMA 350c only) Assigns the Bluetooth device to the audio source. Press the key until the annunciator turns blue. The key annunciator will cycle from OFF to WHITE to BLUE. WHITE selects the wired audio source and BLUE selects the Bluetooth audio source. **NOTE:** The Bluetooth audio can only be assigned to one source at a time. Once the Bluetooth audio is assigned to an audio source, the remaining entertainment audio sources will only cycle between OFF and WHITE.
- 24 **MUS1 Key Annunciator** – (GMA 350c only) Assigns the Bluetooth device to the **MUS1** audio source. Press the **MUS1** key until the annunciator turns blue. The key annunciator will cycle from OFF to WHITE to BLUE. WHITE selects the wired audio source and BLUE selects the Bluetooth audio source. **NOTE:** The Bluetooth audio can only be assigned to one source at a time. Once the Bluetooth audio is assigned to an audio source, the remaining entertainment audio sources will only cycle between OFF and WHITE.
- 25 **MUS2 Key Annunciator** – (GMA 350c only) Assigns the Bluetooth device to the **MUS2** audio source. Press the **MUS2** key until the annunciator turns blue. The key annunciator will cycle from OFF to WHITE to BLUE. WHITE selects the wired audio source and BLUE selects the Bluetooth audio source. **NOTE:** The Bluetooth audio can only be assigned to one source at a time. Once the Bluetooth audio is assigned to an audio source, the remaining entertainment audio sources will only cycle between OFF and WHITE.
- 26 **Control Knob Press and Hold** – (GMA 350c only) Press and hold for two seconds to enable the GMA 350c as discoverable for pairing. The Bluetooth Annunciator with flash to indicate that the unit is discoverable. The unit will remain discoverable for 90 seconds or until a successful pair is established. Once a successful pair is established, the audio “Bluetooth paired” is played.

GMA 347 AUDIO PANEL CONTROLS

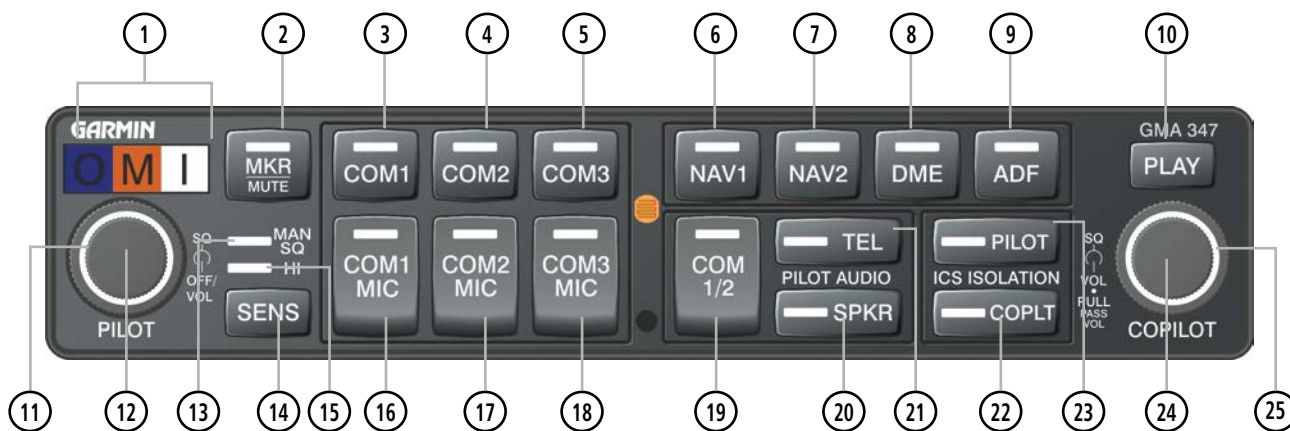

Figure 4-4 GMA 347 Audio Panel Controls

NOTE: When a key is selected, an annunciator in the key is illuminated.

- 1 **Marker Beacon Annunciators** – Each annunciator lights independently when flying over the associated marker beacon station.

- ② **MKR/MUTE** – Selects marker beacon receiver audio. Mutes the currently received marker beacon receiver audio. Unmutes automatically when new marker beacon audio is received. Enables Music Mute feature. Also, stops play of recorded COM audio.
- ③ **COM1** – When selected, audio from the #1 COM receiver can be heard.
- ④ **COM2** – When selected, audio from the #2 COM receiver can be heard.
- ⑤ **COM3** – Reserved for optional COM radio.
- ⑥ **NAV1** – When selected, audio from the #1 NAV receiver can be heard.
- ⑦ **NAV2** – When selected, audio from the #2 NAV receiver can be heard.
- ⑧ **DME** – Turns optional DME audio on or off.
- ⑨ **ADF** – Turns optional ADF receiver audio on or off.
- ⑩ **PLAY** – Press once to play the last recorded COM audio. Press again while audio is playing and the previous block of recorded audio will be played. Each subsequent press plays each previously recorded block. Pressing the **MKR/MUTE** Key during play of a memory block stops play.
- ⑪ **PILOT Squelch** – Turn to adjust Pilot's squelch. The Pilots volume knob must be pressed to allow manual squelch adjustment.
- ⑫ **PILOT Volume** – Turn the left (Pilot) volume knob to control pilot's intercom volume and the ON and OFF function. (Full CCW detent is OFF) Press to switch between manual and automatic squelch control as indicated by illumination of the MAN SQ annunciator.
- ⑬ **MAN SQ** – Manual Squelch annunciator. When lit, pilot and copilot squelch knobs control manual squelch.
- ⑭ **SENS** – Press to increase marker beacon receiver sensitivity as indicated by illumination of the HI SENS annunciator. Press again to return to low sensitivity and extinguish the HI SENS annunciator.
- ⑮ **HI SENS Annunciator** – Indicates marker beacon receiver sensitivity, high sensitivity when illuminated, low sensitivity when extinguished.
- ⑯ **COM1 MIC** – Selects the #1 transmitter for transmitting. COM1 receive is simultaneously selected when this key is pressed allowing received audio from the #1 COM receiver to be heard. COM2 receive can be added by pressing the **COM2** Key.
- ⑰ **COM2 MIC** – Selects the #2 transmitter for transmitting. COM2 receive is simultaneously selected when this key is pressed allowing received audio from the #2 COM receiver to be heard. COM1 receive can be added by pressing the **COM1** Key.
- ⑱ **COM3 MIC** – Reserved for optional COM radio.
- ⑲ **COM 1/2** – Split COM operation key. When selected, the pilot uses the COM 1 transceiver and the copilot uses COM 2.
- ⑳ **SPKR** – Selects and deselects the cabin speaker. COM and NAV receiver audio can be heard on the speaker. Press and hold for 2 seconds for Passenger Address (PA). The **SPKR** key flashes during PA.

- ②① **TEL** – Selects and deselects telephone audio.
- ②② **COPLT** – Selects and deselects the copilot intercom isolation.
- ②③ **PILOT** – Selects and deselects the pilot intercom isolation.
- ②④ **COPILOT/PASS Volume** – Turn to adjust Copilot/Passenger intercom volume or squelch. Pulling the right volume knob controls passenger volume, pushing in controls Copilot volume.
- ②⑤ **COPILOT/PASS Squelch** – Copilot and passenger share the squelch knob.

CONTROL UNIT

The Control Unit is a pedestal-mounted interface allowing data entry, COM and NAV tuning, and transponder control. Many procedures can be performed using the Control Unit rather than the MFD/PFD display bezel controls. Annunciators above the **FMS**, **XPDR**, **NAV**, and **COM** keys are illuminated when their respective control modes are selected.

COM and NAV radio tuning can be accomplished from the control unit. The appropriate frequency box on the selected display is outlined by a light blue selection box, which flashes for a few seconds to indicate control unit activity. Selection of a different display control or radio tuning mode results in cancelation of the previous radio tuning mode.



Figure 4-5 Control Unit

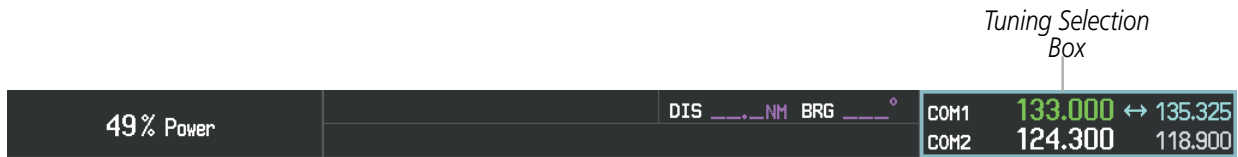

Figure 4-6 Frequency Tuning with the Control Unit

- ① **MENU Key** – Displays a list of options for accessing additional features or making setting changes.
- ② **ENT Key** – Validates or confirms a menu selection or data entry.
- ③ **FMS/XPDR NAV/COM Knob** – NAV/COM Tuning Modes: Acts as the NAV or COM Knob. XPDR Mode: Acts as the **XPDR** Softkey. FMS Control Modes: Acts as the **FMS** Knob.
- ④ **COM Key** – Selects COM radio tuning mode on the Control Unit. The COM tuning box is outlined with a light blue selection line when the COM frequency is active on the control unit (Figure 4-5).
- ⑤ **FMS Key** – Places Control Unit in Flight Management System (FMS) Mode. **FMS** Knob is used to enter transponder codes, select DME modes, and Auto-tune entries when NRST Window is present. Push the **FMS** Knob to turn the selection cursor on and off. The large knob moves the cursor in the window. The small knob selects individual characters for the highlighted cursor location.
- ⑥ **XPDR Key** – Places Control Unit in Transponder Mode. Transponder code entry can be performed with either the number keypad or **FMS/XPDR NAV/COM** Knob.
- ⑦ **NAV Key** – Selects NAV radio tuning mode on the Control Unit. The NAV tuning box is outlined with a light blue selection line when the NAV frequency is active on the control unit.
- ⑧ **CLR Key** – Erases information, cancels entries, or removes menus.
- ⑨ **Frequency Transfer Key (EMERG)** – Transfers the standby and active COM or NAV frequencies. Press and hold for two seconds to tune the emergency frequency (121.500 MHz) automatically into the COM active frequency field.
- ⑩ **Alphanumeric Keys** – Allows data entry (rather than using the FMS Knob to select characters/numbers).
- ⑪ **Decimal Key** – Enters a decimal point.
- ⑫ **BKSP Key** – Moves cursor back one character space and removes last character entered.

4.2 COM OPERATION

COM TRANSCIVER SELECTION AND ACTIVATION



NOTE: When turning on the avionics for use, the system remembers the last frequencies used and the active COM transceiver state prior to shutdown.

The COM Frequency Box is composed of four fields displayed on the PFD; the two active frequencies are on the left side and the two standby frequencies are on the right. The COM transceiver is selected for transmitting by pressing the **COM MIC** Keys on the Audio Panel. During reception of audio from the COM radio selected for transmission, audio from the other COM radio is muted.

An active COM frequency displayed in green indicates that the COM transceiver is selected on the Audio Panel (**COM1 MIC** or **COM2 MIC** Key). Both active COM frequencies appearing in white indicate that no COM radio is selected for transmitting (**SPKR** Key is selected and flashing on the Audio Panel).

Frequencies in the standby field are displayed in light blue and white. The standby frequency in the tuning field is light blue. The other standby frequency is white.

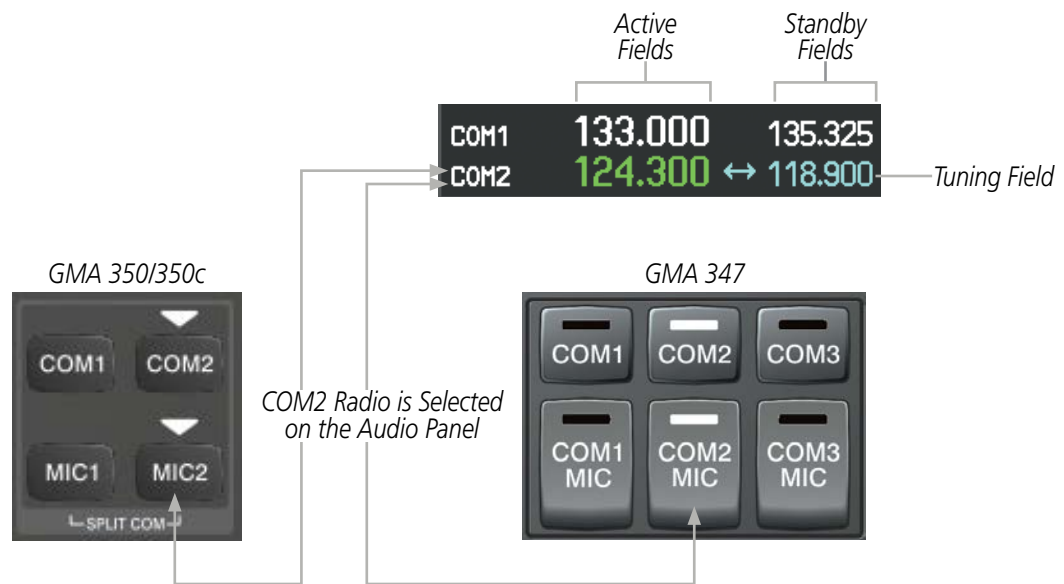

Figure 4-7 Selecting a COM Radio for Transmit

COM3 (GMA 347 only) is reserved for an optional COM radio.

- SYSTEM OVERVIEW
- FLIGHT INSTRUMENTS
- EIS
- AUDIO PANEL & CNS
- FLIGHT MANAGEMENT
- HAZARD AVOIDANCE
- AFCS
- ADDITIONAL FEATURES
- APPENDICES
- INDEX

TRANSMIT/RECEIVE INDICATIONS

During COM transmission, a white TX appears by the active COM frequency replacing the Frequency Transfer Arrow. On the Audio Panel, when the active transceiver **COM MIC** Key Annunciator flashes approximately once per second.

During COM signal reception, a white RX appears by the active COM frequency replacing the Frequency Transfer Arrow.

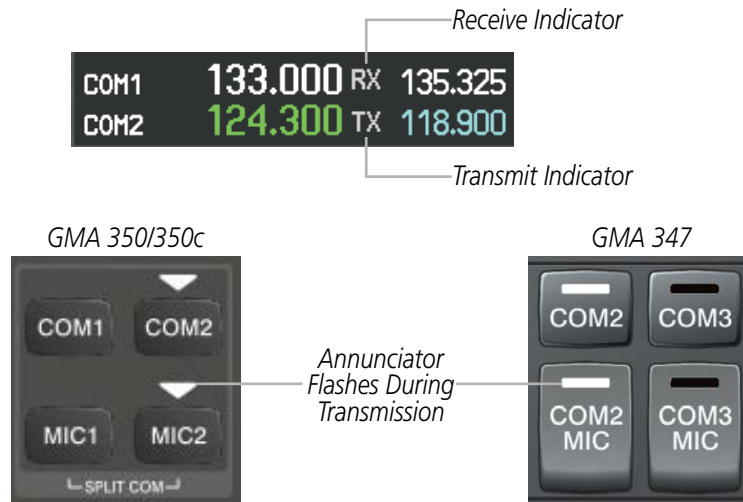

Figure 4-8 COM Radio Transmit and Receive Indications

COM TRANSCEIVER MANUAL TUNING

The COM frequency controls and frequency boxes are on the right side of the MFD and PFD.

Manually tuning a COM frequency:

- 1) Turn the **COM** Knob to tune the desired frequency in the COM Tuning Box (large knob for MHz; small knob for kHz).
- 2) Press the **Frequency Transfer** Key to transfer the frequency to the active field.
- 3) Adjust the volume level with the COM **VOL/SQ** Knob.
- 4) Press the COM **VOL/SQ** Knob to turn automatic squelch on and off.



Figure 4-9 COM Frequency Tuning

Manual frequency tuning from the Control Unit

- 1) Press the **COM** Key to select the COM frequency box.
- 2) Turn the **FMS/XPDR COM/NAV** Knob to tune the desired frequency in the COM Tuning Box (large knob for MHz; small knob for kHz).
- 3) Press the **Frequency Transfer** Key to transfer the frequency to the active field.

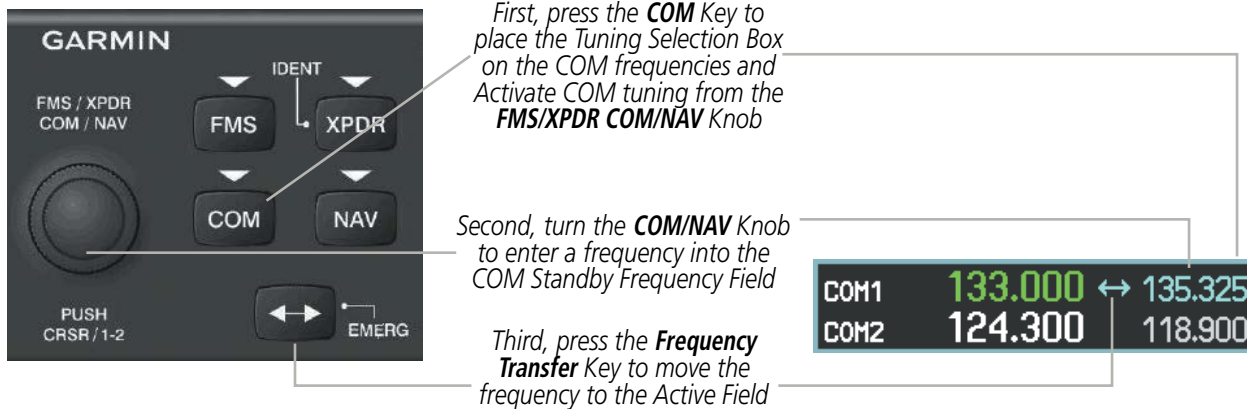

Figure 4-10 Frequency Tuning from the Control Unit

SELECTING THE RADIO TO BE TUNED

Press the small **COM** Knob to transfer the light blue frequency tuning field and Frequency Transfer Arrow between the upper and lower radio frequency fields.

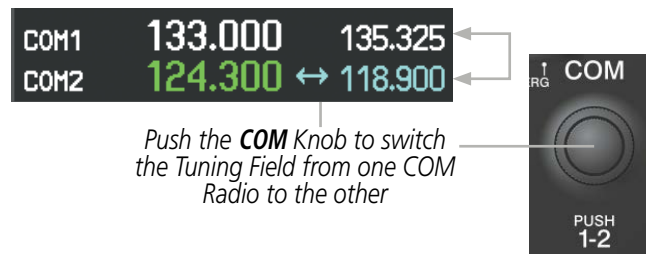

Figure 4-11 Switching COM Tuning Fields

QUICK-TUNING AND ACTIVATING 121.500 MHZ

Pressing and holding the COM **Frequency Transfer** Key for two seconds automatically loads the emergency COM frequency (121.500 MHz) in the active field of the COM radio selected for tuning (the one with the transfer arrow). In the example shown below, pressing the Audio Panel **MIC2** Key (**COM2 MIC** Key on optional GMA 347) would activate **COM2** for transmitting.



Figure 4-12 Quickly Tuning 121.500 MHz

AUTO-TUNING THE COM FREQUENCY

COM frequencies can be automatically tuned from the following:

- NEAREST AIRPORTS Window (PFD)
- WPT – AIRPORT INFORMATION Page
- NRST – NEAREST AIRPORTS Page
- NRST – NEAREST FREQUENCIES Page (ARTCC, FSS, WX)
- NRST – NEAREST AIRSPACES Page

AUTO-TUNING FROM THE PFD

COM frequencies for the nearest airports can be automatically tuned from the NEAREST AIRPORTS Window on the PFD. When the desired frequency is entered, it becomes a standby frequency. Pressing the **Frequency Transfer** Key places this frequency into the COM Active Frequency Field.

Auto-tuning a COM frequency for a nearby airport from the PFD:

- 1) Press the **NRST** Softkey on the PFD to open the NEAREST AIRPORTS Window. A list of 25 nearest airport identifiers and COM frequencies is displayed.
- 2) Turn the **FMS** Knob to scroll through the list and highlight the desired COM frequency.
- 3) Press the **ENT** Key to load the COM frequency into the COM Standby Tuning Box.
- 4) Press the **Frequency Transfer** Key to transfer the frequency to the COM Active Frequency Field.



Press the **NRST** Softkey to open the NEAREST AIRPORTS Window

Figure 4-13 Frequency Auto-Tuning from the PFD

AUTO-TUNING FROM THE MFD

Frequencies can be automatically loaded into the COM Frequency field from pages in the NRST or WPT page group by highlighting the frequency and pressing the **ENT** Key (Figures 4-14, and 4-15).

Auto-tuning a COM frequency from the WPT and NRST Pages:

- 1) From any page that the COM frequency can be auto-tuned, activate the cursor by pushing the **FMS** Knob or the appropriate softkey.
- 2) Turn the **FMS** Knob to place the cursor on the desired COM frequency (Figure 4-15).
- 3) Press the **ENT** Key to load the COM frequency into the standby field of the selected COM radio.
- 4) Press the **Frequency Transfer** Key to transfer the frequency to the COM Active Frequency Field.

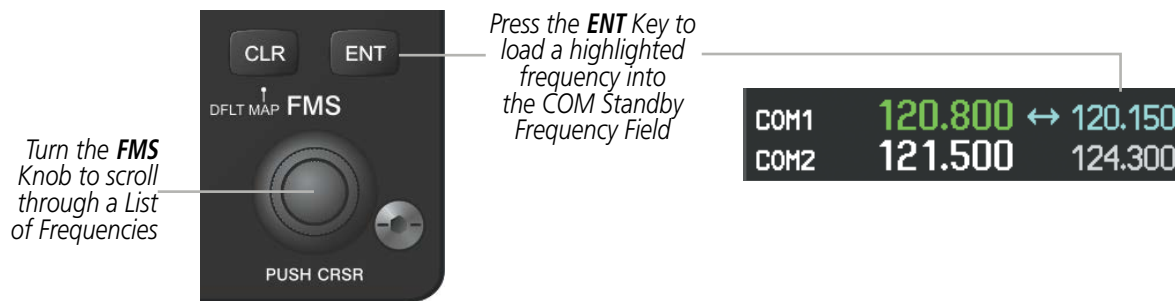

Figure 4-14 Frequency Auto-Tuning from the MFD

Or:

- 1) On the NRST - NEAREST AIRPORTS, NRST - FREQUENCIES, or NRST - AIRSPACES Pages, press the **MENU** Key to display the page menu.
- 2) Turn the large **FMS** Knob to scroll through the menu options.
- 3) Press the **ENT** Key to place the cursor on the desired selection.
- 4) Scroll through the frequency selections with the **FMS** Knob.
- 5) Press the **ENT** Key to load the COM frequency into the standby field of the selected COM radio.
- 6) Press the **Frequency Transfer** Key to transfer the frequency to the COM Active Frequency Field.

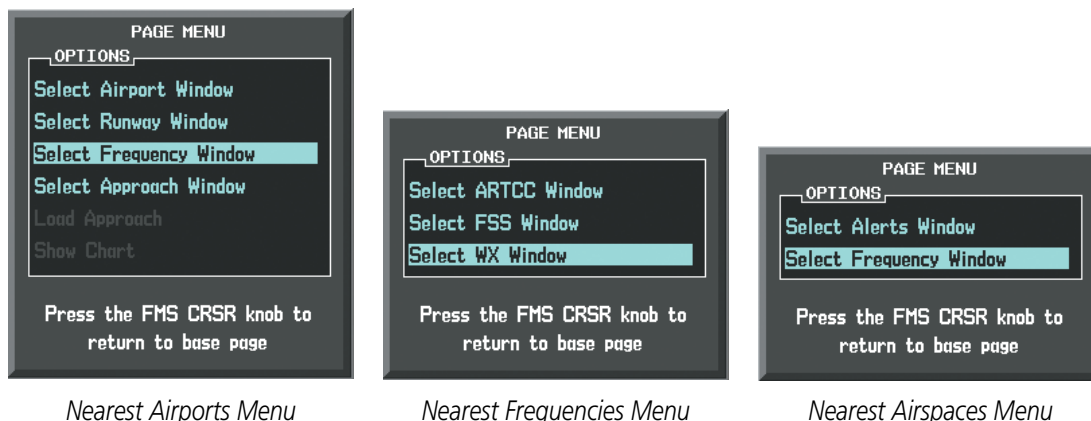
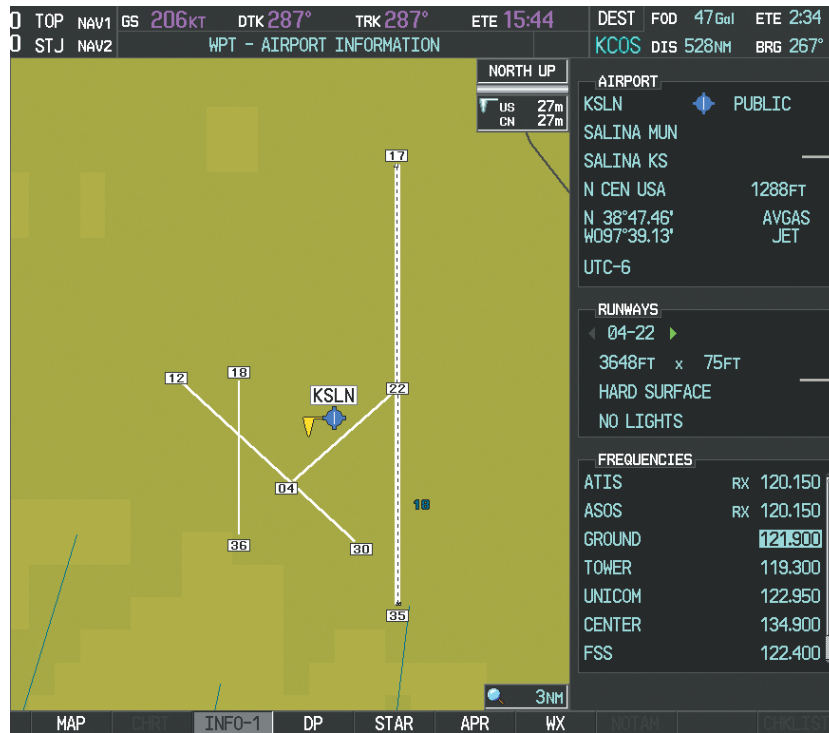

Figure 4-15 Nearest Pages Menus

On the WPT - AIRPORT INFORMATION Page, the cursor can be placed on the frequency field by pushing the **FMS** Knob and scrolling through the list. The frequency is transferred to the COM Standby Field with the **ENT** Key.



Selected Airport Identifier and Information

Runway Information

Press **ENT** Key to load frequency into COM Standby Field. Cursor then advances to the next frequency.

Press **INFO-1** Softkey for AIRPORT, RUNWAYS, and FREQUENCIES Windows

COM Frequency Loads into PFD Standby Frequency Field



Figure 4-16 Airport Information Page and PFD Frequency Display

COM frequencies can also be auto-tuned from the NRST – Nearest Airspaces, NRST – Nearest Frequencies, and NRST – Nearest Airports Pages on the MFD in a similar manner using the appropriate softkeys or **MENU** Key, the **FMS** Knob, and the **ENT** Key.



Figure 4-17 NRST – NEAREST AIRSPACES, NRST – NEAREST AIRPORTS, and NRST – NEAREST FREQUENCIES Pages

FREQUENCY SPACING

The COM radios can tune either 25-kHz spacing (118.000 to 136.975 MHz) or 8.33-kHz spacing (118.000 to 136.990 MHz) for 760-channel or 3040-channel configuration. When 8.33-kHz channel spacing is selected, all of the 25-kHz channel spacing frequencies are also available in the complete 3040-channel list.

COM channel spacing is set on the System Setup Page of the AUX Page Group.

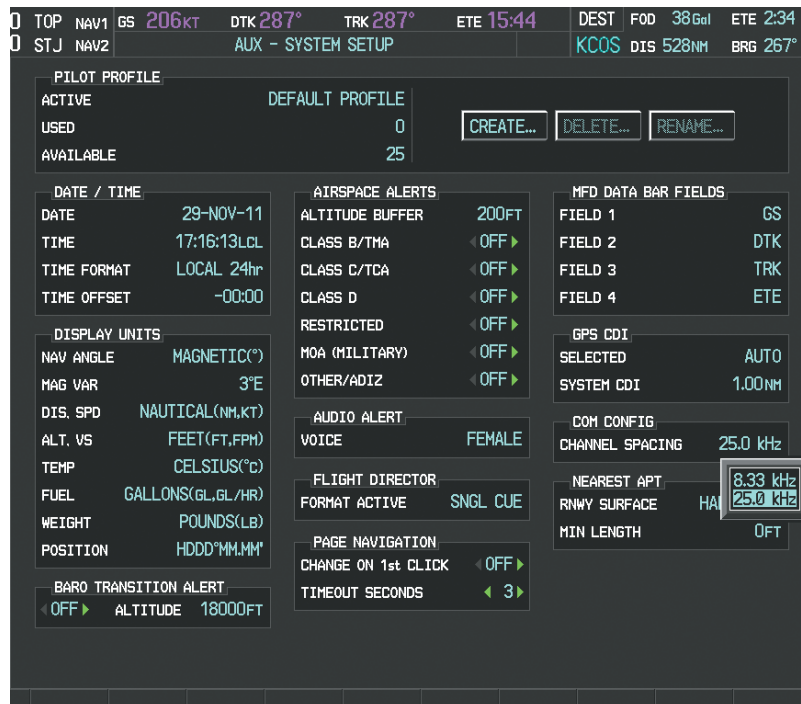

Figure 4-18 COM Channel Spacing

Changing COM frequency channel spacing:

- 1) Select the AUX – System Setup Page.
- 2) Push the **FMS** Knob to activate the flashing cursor.
- 3) Turn the large **FMS** Knob to highlight the Channel Spacing Field in the COM Configuration Box.
- 4) Turn the small **FMS** Knob to select the desired channel spacing.
- 5) Press the **ENT** Key to complete the channel spacing selection.

While the COM CONFIG Window is selected, the softkeys are blank.



Select 8.33-kHz or 25.0-kHz COM Frequency Channel Spacing

Figure 4-19 AUX – System Setup Page

AUTOMATIC SQUELCH

Automatic Squelch quiets unwanted static noise when no audio signal is received, while still providing good sensitivity to weak COM signals. To disable Automatic Squelch, push the **VOL/SQ** Knob. When Automatic Squelch is disabled, COM audio reception is always on. Continuous static noise is heard over the headsets and speaker, if selected. Pushing the **VOL/SQ** Knob again enables Automatic Squelch.

When Automatic Squelch is disabled, a white SQ appears next to the COM frequency.

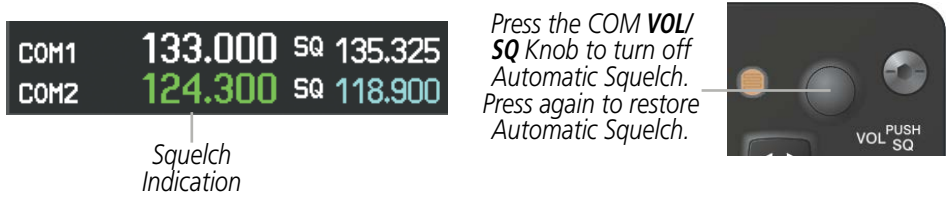

Figure 4-20 Overriding Automatic Squelch

VOLUME

COM radio volume level can be adjusted from 0 to 100% using the **VOL/SQ** Knob. Turning the knob clockwise increases volume, turning the knob counterclockwise decreases volume. When adjusting volume, the level is displayed in place of the standby frequencies. Volume level indication remains for two seconds after the change.

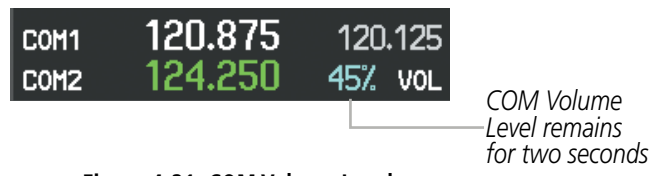

Figure 4-21 COM Volume Level

4.3 NAV OPERATION

NAV RADIO SELECTION AND ACTIVATION

The NAV Frequency Box is composed of four fields displayed on the MFD; two standby fields and two active fields. The active frequencies are on the right side and the standby frequencies are on the left.

A NAV radio is selected for navigation by pressing the **CDI** Softkey located on the PFD. The active NAV frequency selected for navigation is displayed in green. Pressing the **CDI** Softkey once selects NAV1 as the navigation radio. Pressing the **CDI** Softkey a second time selects NAV2 as the navigation radio. Pressing the **CDI** Softkey a third time activates GPS mode. Pressing the **CDI** Softkey again cycles back to NAV1.

While cycling through the **CDI** Softkey selections, the light blue NAV tuning field and the Frequency Transfer Arrow are placed by the active NAV Frequency. The active NAV frequency color changes to green.

The three navigation modes that can be cycled through are:

- VOR1 (or LOC1) – If NAV1 is selected, a green single line arrow (shown) labeled either VOR1 or LOC1 is displayed on the HSI and the active NAV1 frequency is displayed in green.
- VOR2 (or LOC2) – If NAV2 is selected, a green double line arrow (not shown) labeled either VOR2 or LOC2 is displayed on the HSI and the active NAV2 frequency is displayed in green.
- GPS – If GPS Mode is selected, a magenta single line arrow (not shown) appears on the HSI and neither NAV radio is selected. Both active NAV frequencies are then displayed in white.

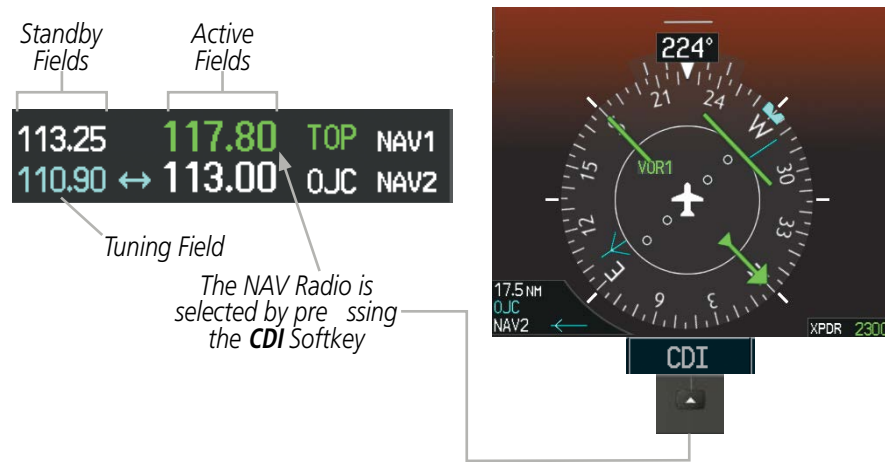

Figure 4-22 Selecting a NAV Radio for Navigation

See the Flight Instruments Section for selecting the DME and Bearing Information windows and using VOR as the source for the bearing pointer.

The NAV Frequency Box displays the decoded Morse Code station identifier that is received from the navigation source. Audio verification of the selected station identifier can be accomplished by selecting the corresponding NAV radio on the audio panel and pressing the **NAV VOL/ID** Knob.

NAV radios are selected for listening by pressing the corresponding keys on the Audio Panel. Pressing the **NAV1**, **NAV2**, or **AUX** Key (**NAV1**, **NAV2**, **DME**, or **ADF** Key on the GMA 347) selects and deselects the navigation radio source. Selection of the **AUX** Key selects and deselects the ADF and DME (if equipped). Selected audio can be heard over the headset and the speakers (if selected).



Figure 4-23 Selecting a NAV Radio Receiver

NAV RECEIVER MANUAL TUNING

The NAV frequency controls and frequency boxes are on the left side of the PFDs.

Manually tuning a NAV frequency:

- 1) Turn the **NAV** Knob to tune the desired frequency in the NAV Tuning Box.
- 2) Press the **Frequency Transfer** Key to transfer the frequency to the NAV Active Frequency Field.
- 3) Adjust the volume level with the NAV **VOL/ID** Knob.
- 4) Press the NAV **VOL/ID** Knob to turn the Morse code identifier audio on and off.

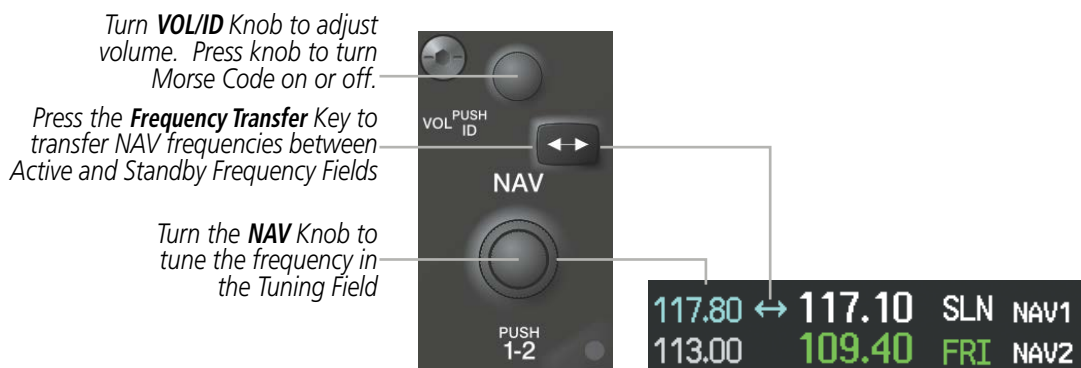

Figure 4-24 NAV Frequency Tuning

SELECTING THE RADIO TO BE TUNED

Press the small **NAV** Knob to transfer the frequency tuning box and Frequency Transfer Arrow between the upper and lower radio frequency fields.

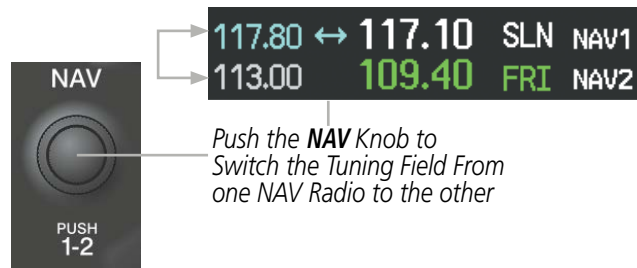

Figure 4-25 Switching NAV Tuning Boxes

VOR/LOC ID

When the Morse code Identifier audio is on for a NAV radio, a white ID appears to the left of the active NAV frequency.

In the example shown, in order to listen to either station identifier, press the **NAV1** or **NAV2** Key on the Audio Panel. Pressing the **VOL/ID** Knob turns off the Morse code audio only in the radio with the NAV Tuning Box. To turn off both NAV IDs, transfer the NAV Tuning Box between NAV1 and NAV2 by pressing the small **NAV** Knob and pressing the **VOL/ID** Knob again to turn the Morse code off in the other radio.



Figure 4-26 NAV Radio ID Indication

VOLUME

NAV Radio volume level can be adjusted from 0 to 100% using the **VOL/ID** Knob. Turning the knob clockwise increases volume, counterclockwise decreases volume.

When adjusting, the level is displayed in place of the standby frequencies. Volume level indication remains for two seconds after the change.

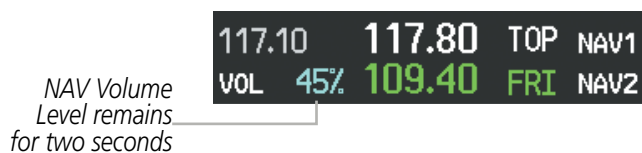

Figure 4-27 NAV Volume Levels

AUTO-TUNING A NAV FREQUENCY FROM THE MFD

NAV frequencies can be selected and loaded from the following MFD pages:

- WPT – AIRPORT INFORMATION
- WPT – VOR INFORMATION
- NRST – NEAREST AIRPORTS
- NRST – NEAREST VOR
- NRST – NEAREST FREQUENCIES (FSS, WX)
- NRST – NEAREST AIRSPACES

The MFD provides auto-tuning of NAV frequencies from waypoint and nearest pages. During enroute navigation, the NAV frequency is entered automatically into the NAV standby frequency field. During approach activation the NAV frequency is entered automatically into the NAV active frequency field.

Frequencies can be automatically loaded into the NAV Frequency Box from pages in the NRST or WPT page group by highlighting the frequency and pressing the **ENT** Key (Figures 4-28, and 4-29).

Auto-tuning a NAV frequency from the WPT and NRST Pages:

- 1) From any page that the NAV frequency can be auto-tuned, activate the cursor by pushing the **FMS** Knob or the appropriate softkey.
- 2) Turn the **FMS** Knob to place the cursor on the desired NAV identifier or NAV frequency.
- 3) On the NRST - Nearest VOR, NRST - Nearest Airspaces, and NRST - Nearest Airports pages, press the **FREQ** Softkey to place the cursor on the NAV frequency (Figure 4-29).
- 4) Press the **ENT** Key to load the NAV frequency into the standby field of the selected NAV radio.
- 5) Press the **Frequency Transfer** Key to transfer the frequency to the NAV Active Frequency Field.

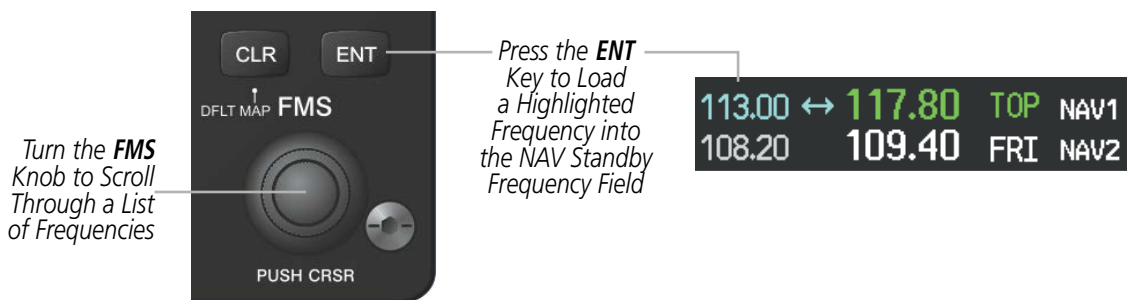

Figure 4-28 NAV Frequency Auto-Tuning from the MFD

Or:

- 1) When on the NRST pages, press the **MENU** Key to display the page menu.
- 2) Turn the large **FMS** Knob to scroll through the menu options.
- 3) Press the **ENT** Key to place the cursor in the desired window.
- 4) Scroll through the frequency selections with the **FMS** Knob.
- 5) Press the **ENT** Key to load the NAV frequency into the standby field of the selected NAV radio.
- 6) Press the **Frequency Transfer** Key to transfer the frequency to the NAV Active Frequency Field.

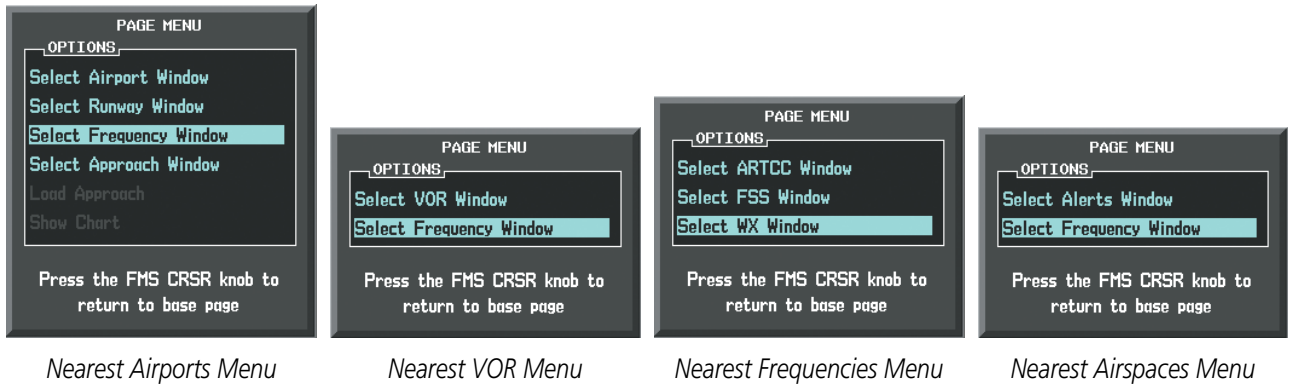

Figure 4-29 Nearest Pages Menus

In the example shown, the VOR list is selected with the **VOR** Softkey or from the page menu. The **FMS** Knob or **ENT** Key is used to scroll through the list. The cursor is placed on the frequency with the **FREQ** Softkey and loaded into the NAV Tuning Box with the **ENT** Key.

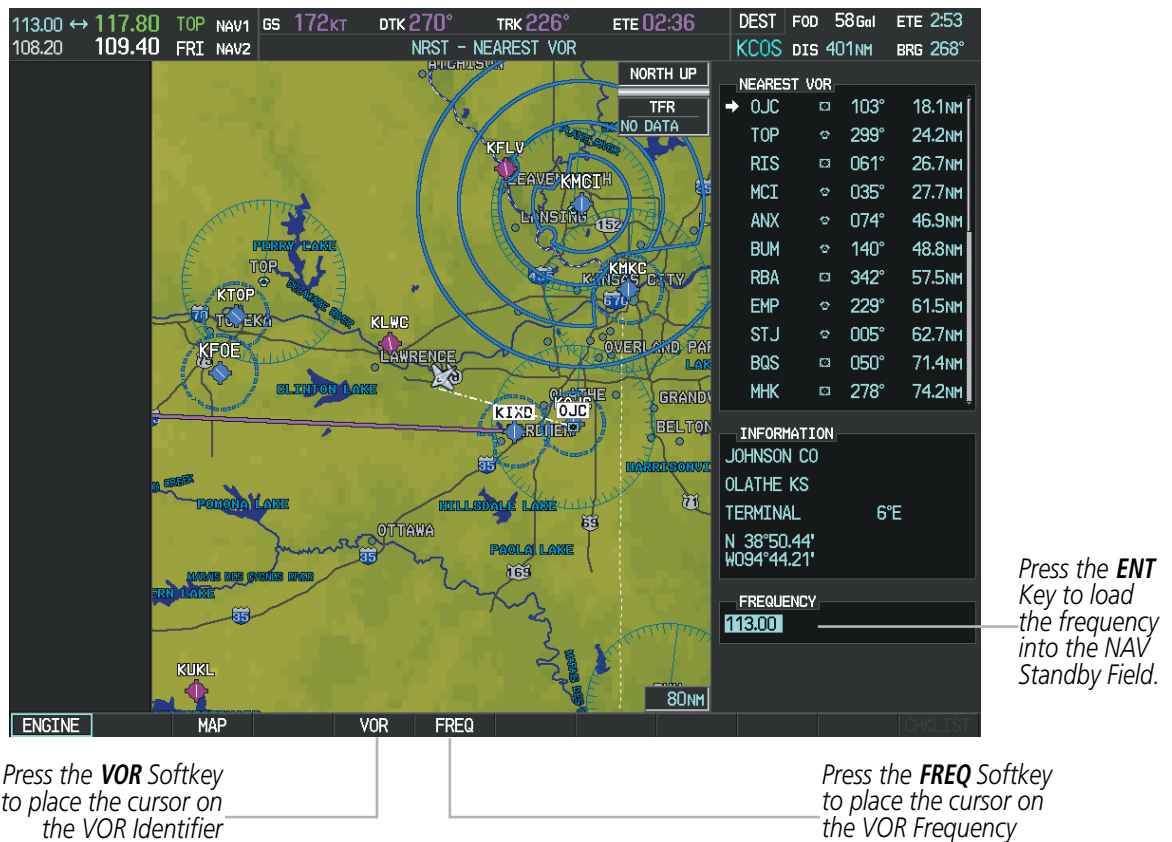

Figure 4-30 Loading the NAV Frequency from the NRST - NEAREST VOR PAGE



While enroute, NAV frequencies can also be auto-tuned from the NRST - NEAREST AIRPORTS, WPT - AIRPORT INFORMATION, WPT - VOR INFORMATION, and NRST - NEAREST FREQUENCIES Pages on the MFD in a similar manner using the appropriate softkeys or **MENU** Key, the **FMS** Knob, and the **ENT** Key.

- SYSTEM OVERVIEW
- FLIGHT INSTRUMENTS
- EIS
- AUDIO PANEL & CNS**
- FLIGHT MANAGEMENT
- HAZARD AVOIDANCE
- AFCS
- ADDITIONAL FEATURES
- APPENDICES
- INDEX



Figure 4-31 NRST – NEAREST FREQUENCIES, WPT – VOR INFORMATION, WPT – AIRPORT INFORMATION, and NRST – NEAREST AIRPORTS Pages

AUTO-TUNING NAV FREQUENCIES ON APPROACH ACTIVATION

-  **NOTE:** The primary NAV frequency is auto-tuned upon loading a VOR or ILS/Localizer approach.
-  **NOTE:** When an ILS/LOC approach has been activated in GPS Mode, the system switches to NAV Mode as the final approach course is intercepted (within 15 nm of the FAF). See the GPS Navigation Section for details.

NAV frequencies are automatically loaded into the NAV Frequency Box on approach activation.

When loading or activating a VOR or ILS/LOC approach, the approach frequency is automatically transferred to a NAV frequency field as follows:

- If the current CDI navigation source is GPS, the approach frequency is transferred to the NAV1 or NAV2 active frequency fields. The frequency that was previously in the NAV1 or NAV2 active frequency fields are transferred to standby.
- If the current CDI navigation source is GPS, and if the approach frequency is already loaded into the NAV1 or NAV2 standby frequency field, the standby frequency is transferred to active.
- If the current CDI navigation source is NAV1 or NAV2, the approach frequency is transferred to the standby frequency fields of the selected CDI NAV radio.

MARKER BEACON RECEIVER

-  **NOTE:** The marker beacon indicators operate independently of marker beacon audio and cannot be turned off.

The marker beacon receiver is used as part of the ILS. The marker beacon receiver is always on and detects any marker beacon signals within the reception range of the aircraft.

The receiver detects the three marker tones – outer, middle, and inner – and provides the marker beacon annunciations located on the Audio Panel and to the left of the Altimeter on the PFD. Operation of the two marker beacon indications may not be synchronized.

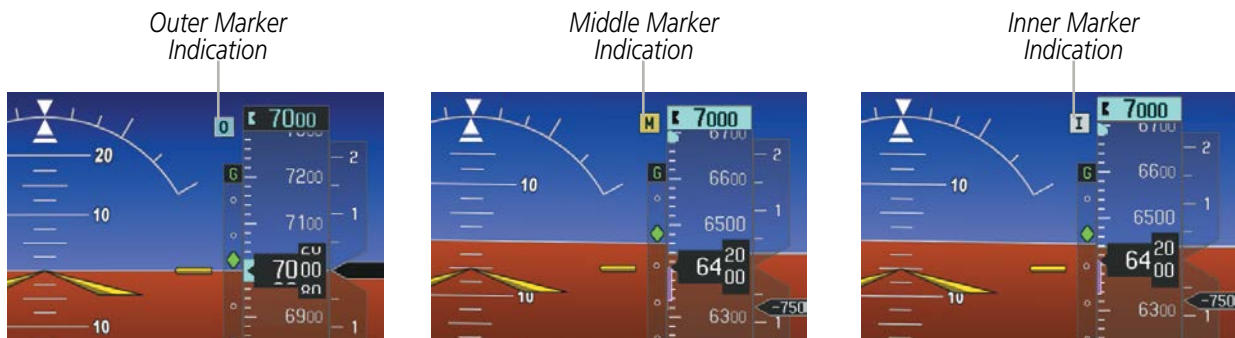

Figure 4-32 Marker Beacon Annunciations on the PFD



Figure 4-33 Marker Beacon Keys and Annunciator Lights

The Audio Panel provides three different states of marker beacon operation; On, Muted, and Deselected. Pressing the **MKR/MUTE** Key selects and deselects marker beacon audio. The key annunciator indicates when marker beacon audio is selected. Marker beacon audio is not heard when the annunciator is off or when the annunciator is on with the marker beacon audio muted.

Turning Marker Beacon Audio On

With the MKR/MUTE annunciator off, press the **MKR/MUTE** Key to enable marker beacon audio.

Muting Marker Beacon Audio

During marker beacon audio reception, press the **MKR/MUTE** Key to mute the audio. The MKR/MUTE annunciator remains lit, but the current marker tone is silenced. Audio muting deactivates automatically and marker beacon audio is heard when the next marker beacon signal is received.

Deselecting Marker Beacon Audio

To deselect marker beacon audio, press the **MKR/MUTE** Key twice during marker beacon reception (once to mute, once more to deselect) or once if a marker beacon signal is not detected.

DME TUNING

NOTE: When another auxiliary window is turned on, the DME Tuning Window is replaced on the PFD.

NOTE: When turning on the Avionics for use, the system remembers the last frequency used for DME tuning and the NAV1, NAV2, or HOLD state prior to shutdown.

The PFD tunes the optional DME transceiver. The UHF DME frequency is tuned by pairing with a VHF NAV frequency. DME frequency pairing is automatic and only the VHF NAV frequency is shown.

The DME Tuning Window is located to the right of the HSI in the lower right corner of the PFD. The DME transceiver is tuned by selecting NAV1, NAV2, or HOLD in the DME Tuning Window. Pressing the **DME** Softkey switches the DME Tuning Window on and off.

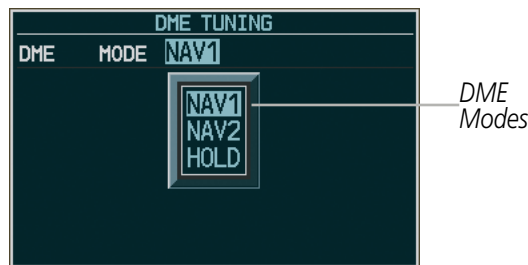

Figure 4-34 DME Tuning Window

The following DME transceiver pairings can be selected:

- NAV1 – Pairs the DME frequency from the selected NAV1 frequency.
- NAV2 – Pairs the DME frequency from the selected NAV2 frequency.
- HOLD – When in the HOLD position, the DME frequency remains paired with the last selected NAV frequency.

Selecting DME transceiver pairing:

- 1) Press the **DME** Softkey to display the DME TUNING Window.
- 2) Turn the small **FMS** Knob to select the DME TUNING mode.
- 3) Press the **ENT** Key to complete the selection.

Pressing the **CLR** Key or **FMS** Knob while in the process of DME pairing cancels the tuning entry and reverts back to the previously selected DME tuning state. Pushing the **FMS** Knob activates/deactivates the cursor in the DME Tuning Window.

See the Flight Instruments Section for displaying the DME information window.

4.4 GTX 32/GTX 33 TRANSPONDER

The GTX 32 Transponder provides Mode A and Mode C interrogation and reply capabilities.

The GTX 33 or GTX 33 with Extended Squitter Mode S Transponder provides Mode A, Mode C, and Mode S interrogation and reply capabilities. Selective addressing or Mode Select (Mode S) capability includes the following features:

- Level-2 reply data link capability (used to exchange information between aircraft and ATC facilities)
- Surveillance identifier capability
- Flight ID (Flight Identification) reporting – The Mode S Transponder reports aircraft identification as either the aircraft registration or a unique Flight ID.
- Altitude reporting
- Airborne status determination
- Transponder capability reporting
- Mode S Enhanced Surveillance (EHS) requirements
- Acquisition squitter – Acquisition squitter, or short squitter, is the transponder 24-bit identification address. The transmission is sent periodically, regardless of the presence of interrogations. The purpose of acquisition squitter is to enable Mode S ground stations and aircraft equipped with a Traffic Avoidance System (TAS) to recognize the presence of Mode S-equipped aircraft for selective interrogation.
- Extended squitter (optional with GTX 33 w/Extended Squitter only) – The extended squitter is transmitted periodically and contains information such as altitude (barometric and GPS), GPS position, and aircraft identification. The purpose of extended squitter is to provide aircraft position and identification to ADS-B Ground-Based Transceivers (GBTs) and other aircraft.

The Hazard Avoidance Section provides more details on traffic avoidance systems.

TRANSPONDER CONTROLS

Transponder function is displayed on three levels of softkeys on the PFD: Top-level, Mode Selection, and Code Selection. When the top-level **XPDR** Softkey is pressed, the Mode Selection softkeys appear: **STBY, ON, ALT, VFR, CODE, IDENT, BACK**.

When the **CODE** Softkey is pressed, the number softkeys appear: **0, 1, 2, 3, 4, 5, 6, 7, IDENT, BKSP, BACK**. The digits 8 and 9 are not used for code entry. Pressing the numbered softkeys in sequence enters the transponder code. If an error is made, pressing the **BKSP** Softkey moves the code selection cursor to the previous digit. Pressing the **BKSP** Softkey again moves the cursor to the next previous digit.

Pressing the **BACK** Softkey during code selection reverts to the Mode Selection Softkeys. Pressing the **BACK** Softkey during mode selection reverts to the top-level softkeys.

The code can also be entered with the **FMS** Knob on the PFD or the **XPDR** Key and numeric keypad or **FMS/XPDR NAV/COM** Knob. Code entry must be completed with either the softkeys, numeric keypad, or the **FMS** Knob, but not a combination of both.

Pressing the **IDENT** Softkey while in Mode or Code Selection initiates the ident function and reverts to the top-level softkeys.

After 45 seconds of transponder control inactivity, the system reverts back to the top-level softkeys.

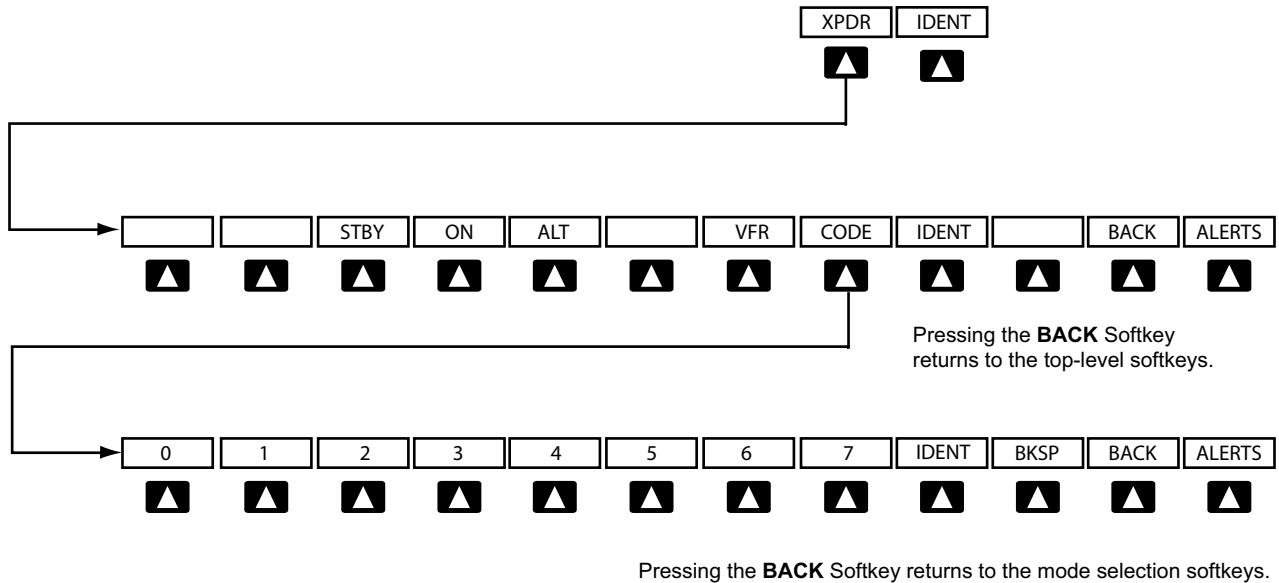

Figure 4-35 Transponder Softkeys (PFD)

While on the ground, the pre-programmed VFR Code (1200) is displayed when the transponder powers up. In the air, the transponder powers up in the last mode it was in when shut down.

TRANSPONDER MODE SELECTION

Mode selection can be automatic (Altitude Mode) or manual (Standby, ON, and Altitude Modes). The **STBY**, **ON**, and **ALT** Softkeys can be accessed by pressing the **XPDR** Softkey.

Selecting a transponder mode:

- 1) Press the **XPDR** Softkey to display the Transponder Mode Selection Softkeys.
- 2) Press the desired softkey to activate the transponder mode.

REPLY STATUS

When the transponder sends replies to interrogations, a white R indication appears momentarily in the reply status field of the Transponder Data Box.

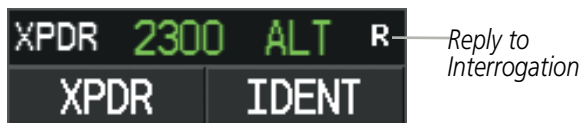

Figure 4-36 Reply Indication

GTX 33 AND GTX 33 W/ES TRANSPONDER MODES

STANDBY MODE (MANUAL)

NOTE: In Standby Mode, the IDENT function is inhibited.

Standby Mode can be selected at any time by pressing the **STBY** Softkey. In Standby, the transponder is powered and new codes can be entered, but no replies or squitters are transmitted. When Standby is selected, a white **STBY** indication and transponder code appear in the mode field of the Transponder Data Box.



Figure 4-37 Standby Mode

MANUAL ON MODE

ON Mode can be selected at any time by pressing the **ON** Softkey. ON Mode generates Mode A and Mode S replies as well as transmission of acquisition and extended squitters, including ADS-B out (if equipped). Mode S replies will not include altitude information. Mode C altitude reporting is inhibited.

The ON indication and transponder code in the Transponder Data Box will appear green while airborne and white while on the ground.

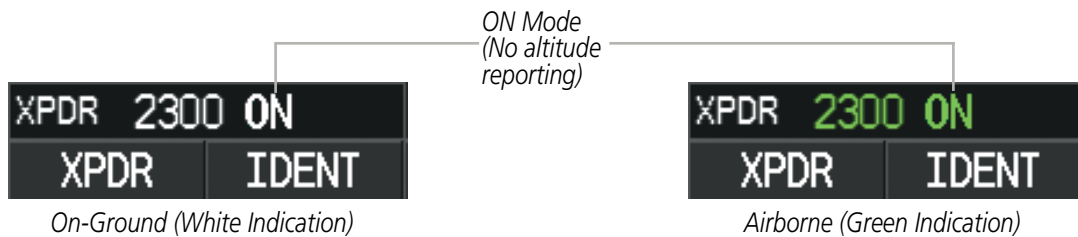

Figure 4-38 ON Mode

ALTITUDE MODE

The white Altitude Reporting Mode is normally selected automatically when the aircraft is on the ground. White Altitude Mode may also be selected manually by pressing the **ALT** Softkey while on the ground. White Altitude Mode generates Mode S replies to discrete interrogations as well as transmission of acquisition and extended squitters, including ADS-B out (if equipped). Mode A, Mode C, and Mode S all-call replies are inhibited.

If Altitude Mode is selected while on the ground, a white ALT indication and transponder code appear in the mode field of the Transponder Data Box.



Figure 4-39 Altitude Mode

The green Altitude Mode is automatically selected when the aircraft becomes airborne. Green Altitude Mode may also be selected manually by pressing the **ALT** Softkey while airborne. Green Altitude Mode generates Mode A, Mode C, and Mode S replies as well as transmissions of acquisition and extended squitters including ADS-B out (if equipped).

If Altitude Mode is selected while airborne, a green ALT indication and transponder code appear in the mode field of the Transponder Data Box, and all transponder replies requesting altitude information are provided with pressure altitude information.



Figure 4-40 Altitude Mode

GTX 32 TRANSPONDER MODES

STANDBY MODE (MANUAL)

NOTE: In Standby Mode, the IDENT function is inhibited.

Standby Mode can be selected at any time by pressing the **STBY** Softkey. In Standby, the transponder is powered and new codes can be entered, but no replies are transmitted. When Standby is selected, a white STBY indication and transponder code appear in the mode field of the Transponder Data Box.



Figure 4-41 Standby Mode

MANUAL ON MODE

ON Mode can be selected at any time by pressing the **ON** Softkey. ON Mode generates Mode A replies. Mode C altitude reporting is inhibited. In ON Mode, a green ON indication and transponder code appear in the mode field of the Transponder Data Box.



Figure 4-42 ON Mode

ALTITUDE MODE

The Altitude Mode is automatically selected when the aircraft becomes airborne. Altitude Mode may also be selected manually by pressing the **ALT** Softkey while airborne. Altitude Mode generates Mode A and Mode C replies. In ALT mode a green ALT indication and transponder code appear in the mode field of the Transponder Data Box, and all transponder replies requesting altitude information are provided with pressure altitude information.



Figure 4-43 Altitude Mode

ENTERING A TRANSPONDER CODE

Entering a transponder code with softkeys:

- 1) Press the **XPDR** Softkey to display the Transponder Mode Selection Softkeys.
- 2) Press the **CODE** Softkey to display the Transponder Code Selection Softkeys, for digit entry.
- 3) Press the digit softkeys to enter the code in the code field. When entering the code, the next softkey in sequence must be pressed within 10 seconds, or the entry is cancelled and restored to the previous code. Pressing the **BKSP** Softkey moves the code selection cursor to the previous digit. Five seconds after the fourth digit has been entered, the transponder code becomes active.



Figure 4-44 Entering a Code with Softkeys

Entering a transponder code with the PFD FMS Knob:

- 1) Press the **XPDR** and the **CODE** Softkey as in the previous procedure to enable code entry.
- 2) Turn the small **FMS** Knob to enter the first two code digits.
- 3) Turn the large **FMS** Knob to move the cursor to the next code field.
- 4) Enter the last two code digits with the small **FMS** Knob.
- 5) Press the **ENT** Key to complete code digit entry.

Pressing the **CLR** Key or small **FMS** Knob before code entry is complete cancels code entry and restores the previous code. Waiting for 10 seconds after code entry is finished activates the code automatically.



Figure 4-45 Entering a Code with the FMS Knob

Entering a transponder code with the Control Unit

- 1) Press the **XPDR** Key to select the transponder function on the **FMS/XPDR COM/NAV** Knob.
- 2) Turn the small **FMS/XPDR COM/NAV** Knob to enter the first two code digits.
- 3) Turn the large **FMS/XPDR COM/NAV** Knob to move the cursor to the next code field.
- 4) Enter the last two code digits with the small **FMS/XPDR COM/NAV** Knob.
- 5) Press the **ENT** Key to complete code digit entry.

Or:

Enter a Code with the Numeric Keypad. Five seconds after the fourth digit has been entered, the transponder code becomes active.

Pressing the **CLR** Key or small **FMS** Knob before code entry is complete cancels code entry and restores the previous code. Waiting for 10 seconds after code entry is finished activates the code automatically.

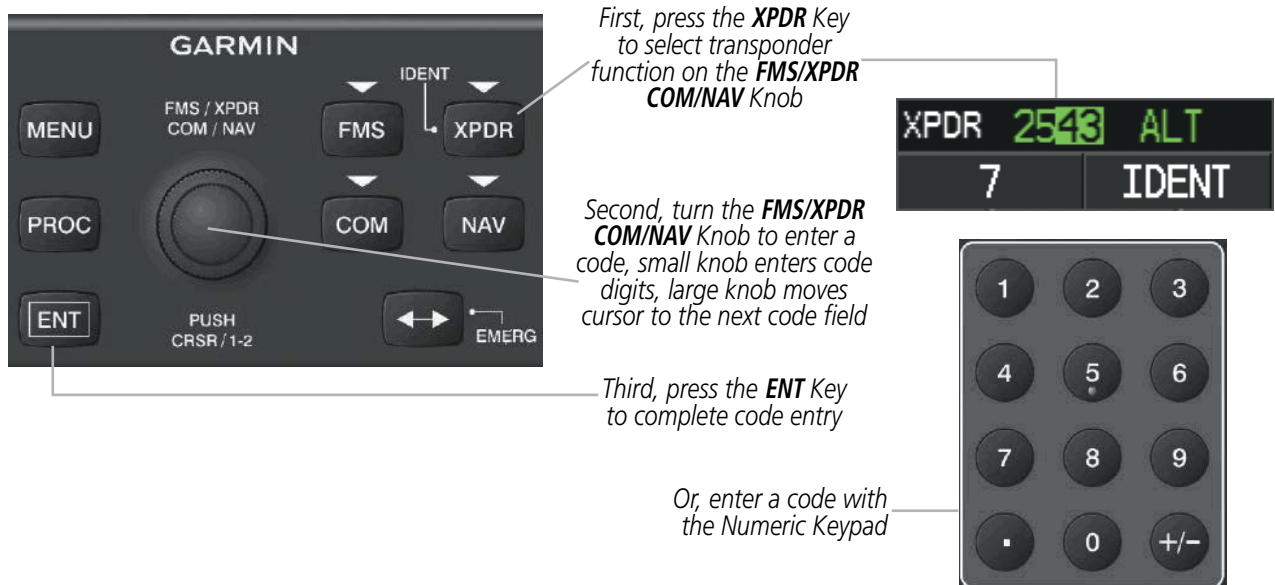

Figure 4-46 Entering a Code with the Control Unit

VFR CODE

The VFR code can be entered either manually or by pressing the **XPDR** Softkey, then the **VFR** Softkey. When the **VFR** Softkey is pressed, the pre-programmed VFR code is automatically displayed in the code field of the Transponder Data Box. Pressing the **VFR** Softkey again restores the previous identification code.

The pre-programmed VFR Code is set at the factory to 1200. If a VFR code change is required, contact a Garmin-authorized service center for configuration.



Figure 4-47 VFR Code

IDENT FUNCTION



NOTE: In Standby Mode, the **IDENT** Softkey is inoperative.

Pressing the **IDENT** Softkey sends a distinct identity indication to Air Traffic Control (ATC). The indication distinguishes the identifying transponder from all the others on the air traffic controller's screen. The **IDENT** Softkey appears on all levels of transponder softkeys. When the **IDENT** Softkey is pressed, a green IDNT indication is displayed in the mode field of the Transponder Data Box for a duration of 18 seconds.

After the **IDENT** Softkey is pressed while in Mode or Code Selection, the system reverts to the top-level softkeys.

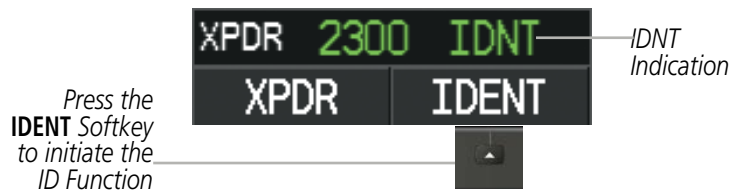

Figure 4-48 IDENT Softkey and Indication

4.5 ADDITIONAL AUDIO PANEL FUNCTIONS

POWER-UP

The Audio Panel performs a self-test during power-up. During the self-test all Audio Panel annunciator lights illuminate for approximately two seconds. Once the self-test is completed, most of the settings are restored to those in use before the unit was last turned off.

MONO/STEREO HEADSETS

Stereo headsets are recommended for use. Using a monaural headset in a stereo jack shorts the right headset channel output to ground. While this does not damage the Audio Panel, a person listening on a monaural headset hears only the left channel in both ears. If a monaural headset is used at one of the passenger positions, any other passenger using a stereo headset hears audio in the left ear only.

SPEAKER

All of the radios can be heard over the cabin speaker. Pressing the **SPKR** Key selects and deselects the cabin speaker. Speaker audio is muted when the PTT is pressed. Certain aural alerts and warnings (autopilot, traffic, altitude) are always heard on the speaker, even when the speaker is not selected.

The speaker volume is adjustable within a nominal range. Contact a Garmin-authorized service center for volume adjustment.



Figure 4-49 Speaker Key

PASSENGER ADDRESS MODE (PA MODE)

Press and hold the **SPKR** Key for 2 seconds to initiate Passenger Address Mode (if configured). PA Mode is annunciated by a rapid blinking of the SPKR annunciator. When in PA Mode the crew can use the PTT “Push-to-Talk” button to deliver announcements over the speaker, to the passenger headsets, or both depending on configuration.

CLEARANCE RECORDER AND PLAYER

The Audio Panel contains a digital clearance recorder that records up to 2.5 minutes of the selected COM radio signal. Recorded COM audio is stored in separate memory blocks. Once 2.5 minutes of recording time have been reached, the recorder begins recording over the stored memory blocks, starting from the oldest block.

The **PLAY** Key controls the play function. Pressing the **PLAY** Key once plays the latest recorded memory block. Pressing the **PLAY** Key while audio is playing begins playing the previously recorded memory block. Each subsequent press of the **PLAY** Key selects the previously recorded memory block.

Pressing the **MKR/MUTE** Key during play of a memory block stops play. If a COM input signal is detected during play of a recorded memory block, play is halted.

Powering off the unit automatically clears all recorded blocks.

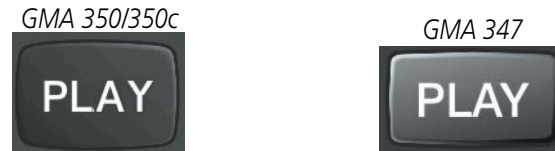

Figure 4-50 Play Key

INTERCOM SYSTEM (ICS) WITH THE GMA 350/350C

The GMA 350/350c includes a six-position intercom system (ICS), two MUSIC inputs, and one telephone/entertainment input for the pilot, copilot and passengers. The intercom provides Pilot, Copilot, and Passenger audio isolation.

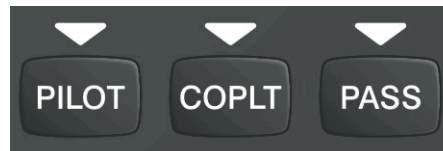

Figure 4-51 Intercom Controls

Press the **PILOT**, **COPLT**, and/or **PASS** Keys to enable intercom audio for the selected position. If the annunciators are lit, those positions will share intercom audio. If an annunciator is NOT lit that position is isolated from the others.

COPILOT CONFIGURED AS CREW OR PASSENGER



NOTE: When the copilot position is configured as a passenger, the **COPLT** Key is disabled and the copilot headset is treated as a 'passenger' for intercom and entertainment audio distribution.

The copilot position can be configured as crew (**COPLT** Key enabled) or as a passenger (**COPLT** Key disabled). Pressing and holding the **COPLT** Key toggles the copilot position configuration between passenger and crew. The aural message “Copilot Configured as Passenger” or “Copilot Configured as Crew” is heard.

INTERCOM MODES

NOTE: In the following modes the copilot position is configured as crew.

ALL INTERCOM MODE

In 'All Intercom' mode the Pilot, Copilot, and Passengers hear each other and hear the aircraft audio.

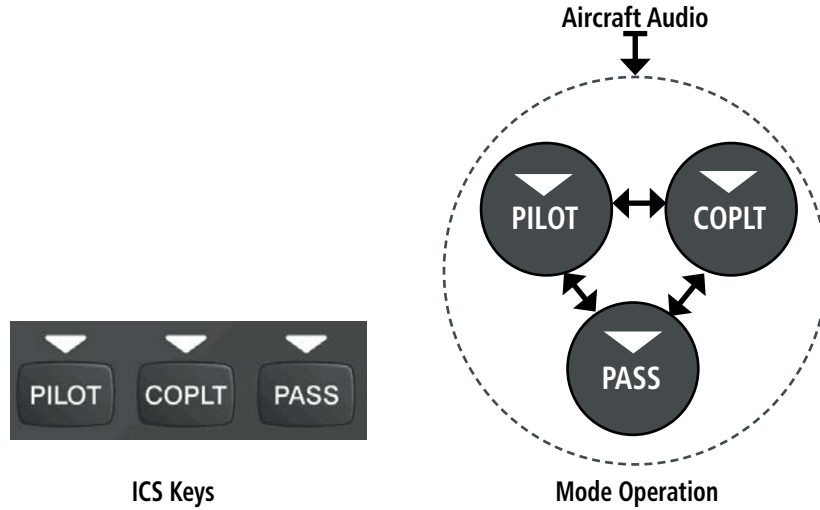

PILOT ISOLATE MODE

In 'Pilot Isolate' mode the Pilot, Copilot, and Passengers hear the aircraft audio. The Copilot and Passengers also hear each other.

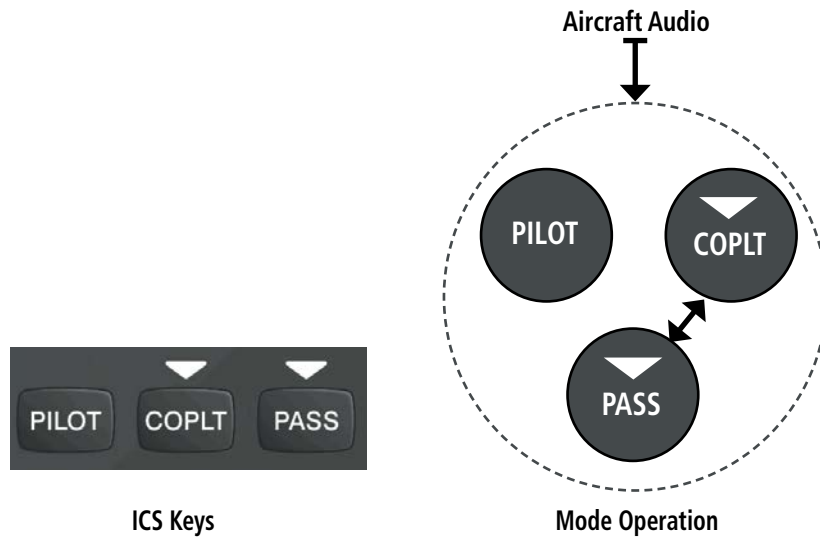

PASSENGER/CREW ISOLATE MODE

In 'Passenger/Crew Isolate' mode the Pilot and Copilot hear the aircraft audio and each other. The Passengers hear each other.

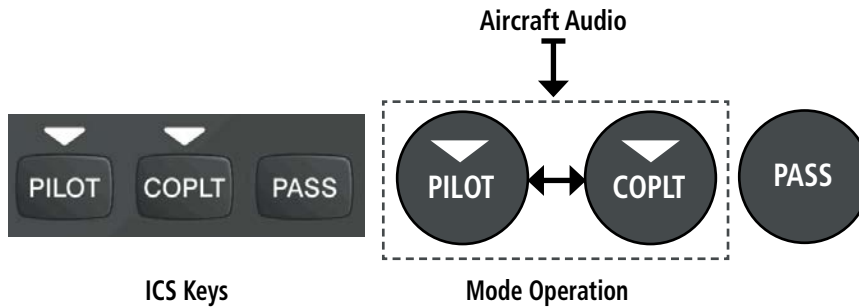

COPILLOT ISOLATE MODE

In 'Copilot Isolate' mode the Pilot, Copilot, and Passengers hear the aircraft audio. The Pilot and Passengers also hear each other.

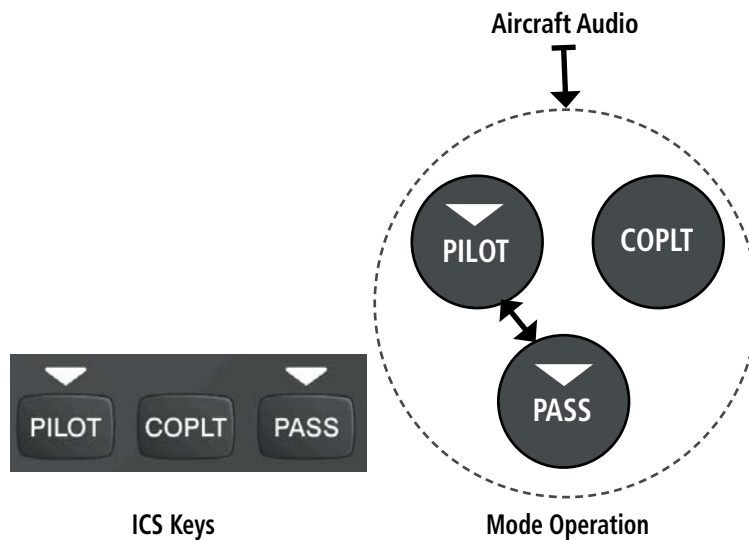

ALL ISOLATE MODE

In 'All Isolate' mode the Pilot and Copilot hear the aircraft audio. The Passengers hear each other.

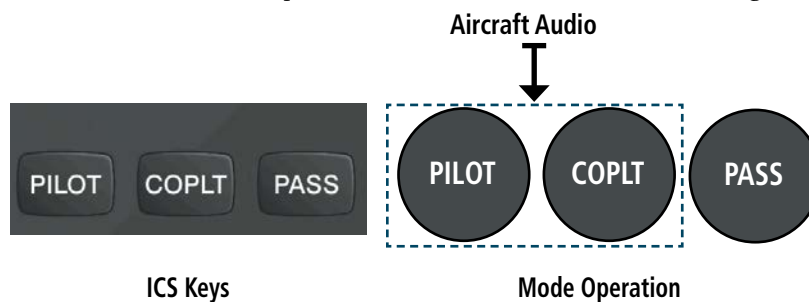

PILOT & COPILOT ISOLATE MODE

In 'Pilot & Copilot Isolate' mode the Pilot, Copilot, and Passengers hear the aircraft audio.

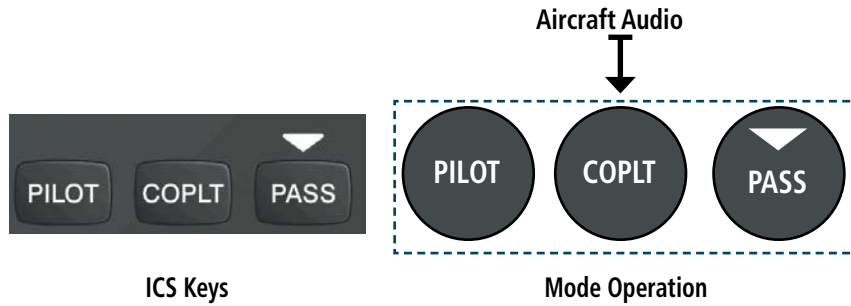

PILOT & PASSENGER ISOLATE MODE

In 'Pilot & Passenger Isolate' mode the Pilot and Copilot hear the aircraft audio. The Passengers hear each other.

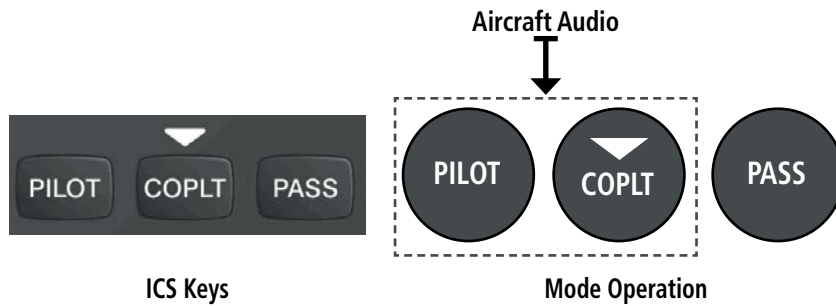

COPILOT & PASSENGER ISOLATE MODE

In 'Copilot & Passenger Isolate' mode the Pilot and Copilot hear the aircraft audio. The Passengers hear each other.

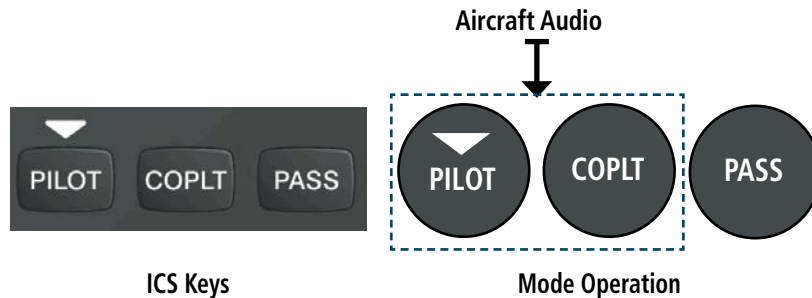

INTERCOM VOLUME AND SQUELCH

The **VOL/CRSR** Knob controls selection and volume or manual squelch adjustment for audio sources that may not be adjustable anywhere else in the system. The small knob controls the volume or squelch. Turning the large knob activates and/or moves the cursor (flashing white annunciator/or flashing blue annunciator in Blue-Select Mode) to select the audio source to adjust. The cursor will time-out after a few seconds and the position of the cursor will always default back to the **PILOT** Key. Pushing the small knob cancels the cursor.

BLUE-SELECT MODE (TELEPHONE/ENTERTAINMENT DISTRIBUTION)

The music (MUS1/MUS2) and telephone/entertainment (🎵) audio are distributed using the Blue-Select Mode. The following example indicates that the pilot, copilot, and passengers will all hear the telephone/entertainment audio.



Figure 4-52 Blue-Select Mode (Telephone/Entertainment Distribution)

The Blue-Select Mode is entered by pushing the small knob when the volume control cursor (flashing white annunciator) is not active. If the volume control cursor is active, push the small knob twice. The first press will cancel the volume control cursor, the second will activate Blue-Select Mode.

The annunciator over the 🎵 Key will be flashing blue. Any combination of the annunciators over the **PILOT**, **COPLT**, and **PASS** buttons may be blue. Select the desired button to turn the blue annunciator on or off to distribute the telephone/entertainment audio to selected crew/passenger positions. Turn the large knob to select **MUS1** or **MUS2** and select the crew positions to receive the music audio.

Selecting any key other than **PILOT**, **COPLT**, **PASS**, **MUS1**, **MUS2**, or 🎵 will cancel Blue-Select Mode. Pushing the small knob will also cancel Blue-Select Mode. After approximately ten seconds with no input, the Blue-Select Mode will automatically cancel.

ADJUSTING INTERCOM VOLUME

When the cursor is on **PILOT**, **COPLT**, or **PASS**, the Volume Control Knob adjusts the intercom volume for the listener.

ADJUSTING SPEAKER VOLUME

When the cursor is on **SPKR**, the Volume Control Knob adjusts the speaker volume of the selected sources (COM, NAV, AUX, MKR). Alert volumes are not affected by the speaker volume control knob.

ADJUSTING MKR, AUX, 🎵, AND MUSIC VOLUME

When the cursor is on **MKR**, **AUX**, 🎵, **MUS1** or **MUS2**, the Volume Control Knob adjusts the individual volume of the selected source.

ADJUSTING MANUAL SQUELCH

When the cursor is on **MAN SQ**, the Volume Control Knob adjusts the ICS Squelch Threshold (the volume level that must be exceeded to be heard over the intercom).



Figure 4-53 Volume/Squelch Control

SPLIT COM MODE WITH THE GMA 350/350C



NOTE: Split COM performance is affected by the distance between the COM antennas and the separation of the tuned frequencies. If the selected COM frequencies are too close together, interference may be heard during transmission on the other radio.

During Split COM operation, both the pilot and the copilot can transmit simultaneously over separate radios. In Split COM mode, the pilot uses COM1 and the copilot uses COM2.

Pressing both **MIC** Keys simultaneously initiates Split COM Mode (i.e., COM1/COM2). The respective COM1/MIC1 or COM2/MIC2 annunciators are illuminated indicating Split COM operation. Split COM operation is cancelled by pressing one of the selected MIC Keys again.



Figure 4-54 Split COM Selected

3D AUDIO (GMA 350/350C ONLY)

3D Audio is useful when multiple audio sources are present. By using different responses in each ear, 3D audio processing creates the illusion that each audio source is coming from a unique location or seat position.

Because this feature uses different signals for left and right channels, it requires wiring for stereo intercom and stereo headsets. If 3D audio is activated when mono headsets are in use, the listener will still hear all audio sources; however, there is no benefit from location separation.

With a single COM selected and 3D Audio enabled, the listener hears the audio source at the 12 o'clock position. If both COMs are selected, the listener hears COM1 at 11 o'clock and COM2 at the 1 o'clock position. All other intercom positions are processed to sound like their relative seat location. By default, the GMA350 assumes the pilot sits in the left seat. A Garmin authorized service center can make changes to the default configuration.

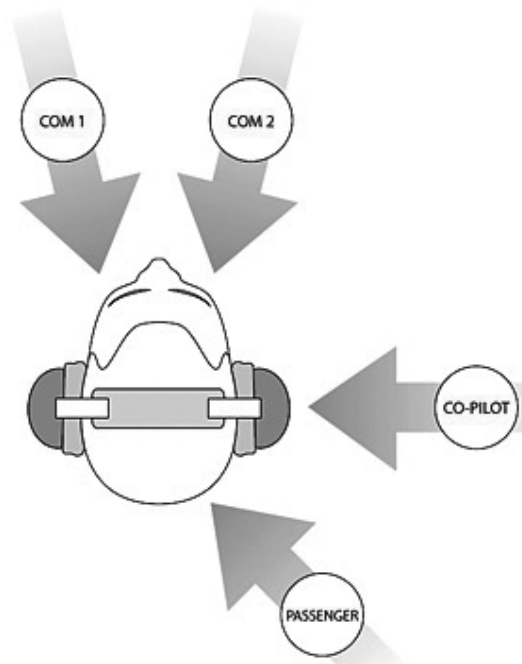

ENABLING 3D AUDIO

Press and hold the **PILOT** Key to toggle 3D audio processing on and off for all headset positions. When 3D Audio is enabled, the aural message “3D audio left” is heard in the left ear followed by “3D audio right” in the right ear. If the aural messages are not heard in only the left and then the right ear respectively, the cause may be aircraft wiring or headset settings. Refer to the following table if a headset or aircraft wiring problem is suspected.

3D Audio Troubleshooting			
Symptom(s)	Cause(s)		Solution(s)
“3D audio left” message heard in both ears. “3D audio right” message not heard	1)	Mono headset in use	1) Use a stereo headset
	2)	Stereo headset in use with mono/stereo switch set to ‘mono’	2) Set mono/stereo switch on headset to ‘stereo’
	3)	Aircraft wiring has left audio wired to both left and right channels of stereo headset jack	3) If after checking solutions #1 and #2 see a service center as soon as possible to inspect/correct wiring. This wiring fault can cause fail-safe audio not to function.

3D Audio Troubleshooting				
"3D audio left" message heard in both ears, followed by "3D audio right" message heard in both ears	1)	Mono headset in use	1)	Use a stereo headset
	2)	Stereo headset in use with mono/stereo switch set to mono	2)	Set mono/stereo switch on headset to 'stereo'
	3)	Incorrect aircraft wiring (left/right shorted together)	3)	If after checking solutions #1 and #2 see a service center as soon as possible to inspect/correct wiring. This wiring fault can cause fail-safe audio not to function.
"3D audio right" message heard in both ears. "3D audio left" not heard	1)	Incorrect aircraft wiring (right channel used for mono instead of left or left/right swapped)	1)	See a service center as soon as possible to inspect/correct wiring. This wiring fault can cause fail-safe audio not to function.
"3D audio left" message heard in right ear only followed by "3D audio right" message heard in left ear only	1)	Stereo headset is on backwards	1)	Verify correct orientation from the left/right indication on each side of the headset or the position of the boom mic (usually attached on left side). If the headset is backwards left/right position information will be swapped.
	2)	Incorrect aircraft wiring (left/right channels swapped)	2)	See a service center as soon as possible to inspect/correct wiring. This wiring fault can cause fail-safe audio not to function.
"3D audio left" message heard in left ear only, no audio heard in right ear.	1)	Aircraft wired for mono intercom	1)	See a service center to wire the installation for stereo headsets.
"3D audio right" message heard in right ear only, no audio heard in left ear	1)	Incorrect aircraft wiring (right channel used for mono instead of left, or left/right swapped)	1)	See a service center as soon as possible to inspect/correct wiring. This wiring fault can cause fail-safe audio not to function.

INTERCOM WITH THE GMA 347

The Audio Panel includes a four-position intercom system (ICS) and two stereo music inputs for the pilot, copilot and up to two passengers. The intercom provides Pilot and Copilot isolation from the passengers and aircraft radios.



Figure 4-55 Intercom Controls

PILOT KEY Annunciator	COPLT KEY Annunciator	TEL KEY Annunciator	Pilot Hears	Copilot Hears	Passenger Hears	Input to Phone
OFF	OFF	OFF	Selected radios, aural alerts, pilot, copilot, passengers, music1	Selected radios, aural alerts, pilot, copilot, passengers, music1	Selected radios, aural alerts, pilot, copilot, passengers, music2	None
OFF	OFF	ON	Selected radios, aural alerts, pilot, copilot, passengers, music1, TEL audio	Selected radios, aural alerts, pilot, copilot, passengers, music1, TEL audio	Selected radios, aural alerts, pilot, copilot, passengers, music2, TEL audio	Pilot, copilot, passengers
ON	OFF	OFF	Selected radios, aural alerts, pilot	Copilot, passengers, music1, TEL audio	Copilot, passengers, music2, TEL audio	Copilot, passengers
ON	OFF	ON	Selected radios, aural alerts, pilot, TEL audio	Copilot, passengers, music1	Copilot, passengers, music2	Pilot
OFF	ON	OFF	Selected radios, aural alerts, pilot; passengers, music1	Copilot, TEL audio	Selected radios, aural alerts, pilot, passengers, music2	Copilot
OFF	ON	ON	Selected radios, aural alerts, pilot; passengers, music1, TEL audio	Copilot	Selected radios, aural alerts, pilot, passengers, music2, TEL audio	Pilot, passengers
ON	ON	OFF	Selected radios, aural alerts, pilot, copilot	Selected radios, aural alerts, pilot, copilot	Passengers, music2, TEL audio	Passengers
ON	ON	ON	Selected radios, aural alerts, pilot, copilot, TEL audio	Selected radios, aural alerts, pilot, copilot, TEL audio	Passengers, music2	Pilot, copilot

Table 4-1 ICS Isolation Modes & Telephone Distribution

Pilot isolation is selected when the PILOT Annunciator is illuminated. During Pilot isolation, the pilot can hear the selected radios and aural alerts and warnings. The copilot and passengers can communicate with each other. The copilot is isolated from aural alerts and warnings.

Copilot isolation is selected when the COPLT Annunciator is illuminated. The copilot is isolated from the selected radios, aural alerts and warnings, and everyone else. The pilot and passengers can hear the selected radios, aural alerts, and communicate with each other.

When both the PILOT and COPLT Annunciators are illuminated, the pilot and copilot can hear the selected radios, aural alerts, and communicate with each other. The passengers are isolated from the pilot and copilot but can communicate with each other.

When both the PILOT and COPLT Annunciators are extinguished, everyone hears the selected radios, aural alerts, and is able to communicate with everyone else.

- SYSTEM OVERVIEW
- FLIGHT INSTRUMENTS
- EIS
- AUDIO PANEL & CNS
- FLIGHT MANAGEMENT
- HAZARD AVOIDANCE
- AFCS
- ADDITIONAL FEATURES
- APPENDICES
- INDEX

INTERCOM VOLUME AND SQUELCH

Two volume controls, one for the pilot and a combined copilot/passenger control, set intercom audio level.

Each microphone input has an automatic squelch threshold. Manual squelch is available by pressing the Pilot side **VOL/SQ** knob. When the MAN SQ annunciation is lit the large squelch knobs control pilot and copilot/passenger squelch threshold. Turning either knob clockwise increases the squelch threshold level. Turning either knob counterclockwise decreases the squelch threshold level.

When the MAN SQ annunciation is not lit, squelch is automatic and the large squelch knobs have no function.

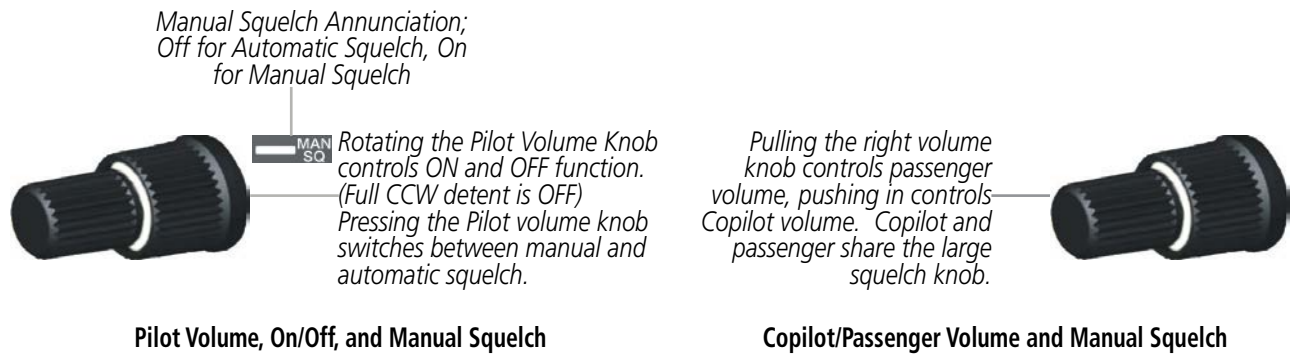

Figure 4-56 Intercom Volume and Squelch Controls

SPLIT COM WITH THE GMA 347

NOTE: Split COM performance is affected by the distance between the COM antennas and the separation of the tuned frequencies. If the selected COM1 and COM2 frequencies are too close together, interference may be heard during transmission on the other radio.

During Split COM operation, both the pilot and the copilot can transmit simultaneously over separate radios. The pilot can still monitor NAV1, NAV2, ADF, DME, and MKR Audio as selected, but the copilot is only able to monitor COM2.

Pressing the **COM 1/2** Key selects Split COM operation. The COM 1/2 Annunciator is illuminated indicating Split COM operation. COM1 and COM2 frequencies are displayed in green indicating that both transceivers are active. Split COM operation is cancelled by pressing the **COM 1/2** Key again, at which time the annunciator is extinguished.

When Split COM operation is selected, COM1 is used by the pilot and COM2 is used by the copilot. The COM1 MIC Annunciator flashes when the pilot's microphone PTT is pressed. The COM2 MIC Annunciator flashes when the copilot's microphone PTT is pressed.

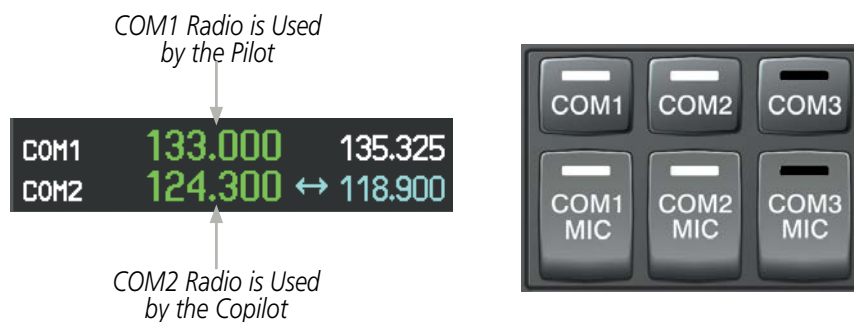

Figure 4-57 Split COM Operation

ENTERTAINMENT INPUTS WITH THE GMA 350

The GMA 350/350c provides three stereo telephone/entertainment inputs:

- The telephone/entertainment (🎵) Key controls a telephone or entertainment device connected to the rear of the audio panel or to the Front Panel Jack. For GSR 56 equipped aircraft, the Iridium phone audio is connected to the rear input of the audio panel. To use the Iridium phone, ensure there is no other audio source plugged into the Front Panel Jack.
- The **MUS1** and **MUS2** Key controls the Entertainment Music audio input. External audio jacks can also be used as an entertainment input. GDL 69 (SiriusXM Radio) audio, if equipped, is wired to the MUS1 and MUS2 inputs. The Front Panel Jack does not disable audio connected to the MUS1 and MUS2 inputs.

The Front Panel Jack can be used as an entertainment input or a telephone input. Plugging a device into the Front Panel Jack will disable any audio source connected to the rear telephone/entertainment jack (i.e. GSR 56, if so equipped). The Front Panel Jack is a 3.5-mm stereo jack that is compatible with popular portable entertainment devices such as MP3s, CD players, and cell phones. The headphone outputs of the entertainment devices are plugged into the Front Panel Jack.

Distribution of the entertainment inputs are configured in Blue-Select Mode.

TELEPHONE AND ENTERTAINMENT MUTING

Telephone and entertainment muting can be enabled or disabled by the user, however it is always muted during alerts.

ENABLING/DISABLING MUTING

Press and hold the **MUS1**, **MUS2**, or () Key for two seconds to toggle muting on and off. The aural message “**Mute Music on Reception Enabled/Disabled**” or “**Mute Tel and Jack on Reception Enabled/Disabled**” is heard.

ENTERTAINMENT INPUTS WITH THE GMA 347



NOTE: *Music1 and Music2 audio cannot be completely turned off. Audio level for the crew and passengers can be adjusted by a Garmin-authorized service center.*

The Audio Panel provides two stereo auxiliary entertainment inputs: Music1 and Music2. The pilot and copilot hear Music1 and the passengers hear Music2. These inputs are compatible with popular portable entertainment devices such as MP3 and CD players. Two 3.5-mm stereo phone jacks are installed in convenient locations for audio connection. The headphone outputs of the entertainment devices are plugged into the Music1 or Music2 jacks.

The current ICS state of isolation affects the distribution of the entertainment input (see Table 4-1).

CREW MUSIC

Crew music, either SiriusXM Radio or Music1, can be heard by the pilot and copilot when both the PILOT and the COPLT ICS Annunciators are extinguished. Crew music can also be heard by the pilot when the COPLT Annunciator is illuminated and by the copilot when the PILOT Annunciator is illuminated.

MUSIC MUTING

Crew music muting occurs when aircraft radio or marker beacon activity is heard. Crew music is always soft muted when an interruption occurs from these sources. Soft muting is the gradual return of music to its original volume level. The time required for music volume to return to normal is between one-half and four seconds.

MUSIC MUTING ENABLE/DISABLE

Pressing and holding the **MKR/MUTE** Key for three seconds switches crew music muting on and off. When switching, either one or two beeps are heard; one beep indicates that music muting is enabled, two beeps indicate music muting is disabled. Crew music muting is reset (enabled) during power up.

PASSENGER MUSIC

Passenger music, either SiriusXM Radio or Music2, can be heard only by the passengers and is never muted.

SIRIUSXM RADIO ENTERTAINMENT

SiriusXM Radio audio may be heard by the pilot and passengers simultaneously (optional: requires subscription to SiriusXM Radio Service). Refer to the Additional Features Section for more details on the Data Link Receiver.

Connecting a stereo input to the audio jack disables the SiriusXM Radio audio from that input.

BLUETOOTH[®] (GMA 350c ONLY)



NOTE: Pairing is only necessary during the first attempt to connect a Bluetooth device to the GMA 350c. Once paired, the GMA 350c and the device will connect automatically.

PAIRING A BLUETOOTH DEVICE WITH THE GMA 350c

Press and hold the inner knob for two seconds. The Bluetooth Annunciator flashes to indicate the unit is discoverable and the aural message “**Bluetooth discoverable**” is heard. The GMA 350c will remain discoverable for 90 seconds or until a successful pair is established. Once paired, the Bluetooth Annunciator turns steady blue and the aural message “**Bluetooth connected/paired**” is heard.

ASSIGNING AN AUDIO SOURCE TO THE BLUETOOTH DEVICE

Press the **MUS1**, **MUS2**, or **MUS3** key until the annunciator turns blue (the audio from the Bluetooth source will not be heard until this step is complete). The key annunciator cycles OFF-WHITE-BLUE. WHITE selects the wired audio source. BLUE selects the Bluetooth audio source. The BLUE source assignment will persist through Bluetooth audio connection disruptions.



NOTE: The Bluetooth audio can only be assigned to one source at a time. Once the Bluetooth audio is assigned to an audio source, the remaining entertainment audio sources will only cycle between OFF and WHITE.

Bluetooth audio will maintain a separate volume level and Blue Select distribution from the wired audio source. If the Bluetooth connection is supporting a phone call, all intercom positions listening to that source can also speak on the call through the headset MICs.

ADDITIONAL BLUETOOTH CONTROL FUNCTIONS

In addition to the 2 second press and hold of the inner knob discussed above, the knob has two additional functions that are intended to be seldom or never used. The following functions are available if needed for troubleshooting:

- Press and hold the inner knob for 5 seconds to turn off the Bluetooth radio. The aural message “**Bluetooth off**” is heard. This function electrically turns off the radio, not just the audio source selection. In the event that Bluetooth radio interference with communication or navigation equipment is suspected, the Bluetooth radio can be powered off without powering off the entire audio panel. A subsequent 5 second press and hold turns the radio back on.
- Press and hold the inner knob for 10 seconds to clear the memory of paired devices (up to 10 are stored). Once cleared, the aural message “**Bluetooth list cleared**” is heard. This function is used as a troubleshooting method when a device is not pairing, or to remove a device that is no longer needed.

4.6 AUDIO PANEL PREFLIGHT PROCEDURE



NOTE: If the pilot and/or copilot are using headsets that have a high/low switch or volume control knob, verify that the switch is in the high position and the volume control on the headsets are at maximum volume setting. On single-pilot flights, verify that all other headsets are not connected to avoid excess noise in the audio system.



NOTE: When the **MAN SQ** Key is pressed, the ICS squelch can be set manually by the pilot and copilot. If manual squelch is set to full open, background noise is heard in the ICS system as well as during COM transmissions.

GMA 350/350C PREFLIGHT

After powering up the system, the following steps aid in maximizing the use of the Audio Panel as well as prevent pilot and copilot induced issues. These preflight procedures should be performed each time a pilot boards the aircraft to insure awareness of all audio levels in the Audio Panel and radios.

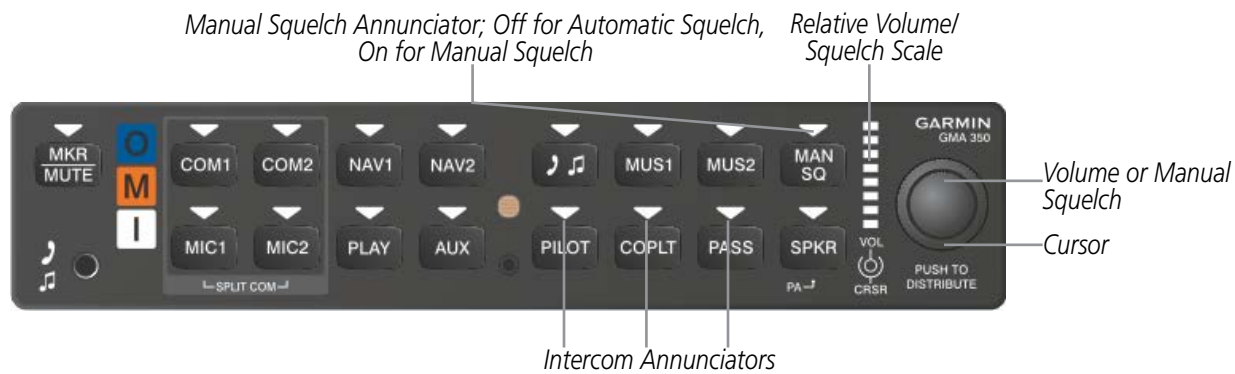



Figure 4-58 Audio Panel Controls

Setting the Audio Panel during preflight:

- 1) Verify that the PILOT, COPLT and PASS annunciators are lit.
- 2) Adjust radio volume levels (COM, NAV) to a suitable level.
- 3) Use the Blue-Select Mode to distribute the telephone/entertainment (), MUS1, and MUS2 appropriately.
- 4) Use the **VOL/CRSR** Knobs to adjust the intercom volumes to the desired level.

Once this procedure has been completed, the pilot and copilot can change settings, keeping in mind the notes above.

GMA 347 PREFLIGHT

After powering up the avionics System, the following steps will aid in maximizing the use of the Audio Panel as well as prevent pilot and copilot induced issues. These preflight procedures should be performed each time a pilot boards the aircraft to insure awareness of all audio levels in the Audio Panel and radios.

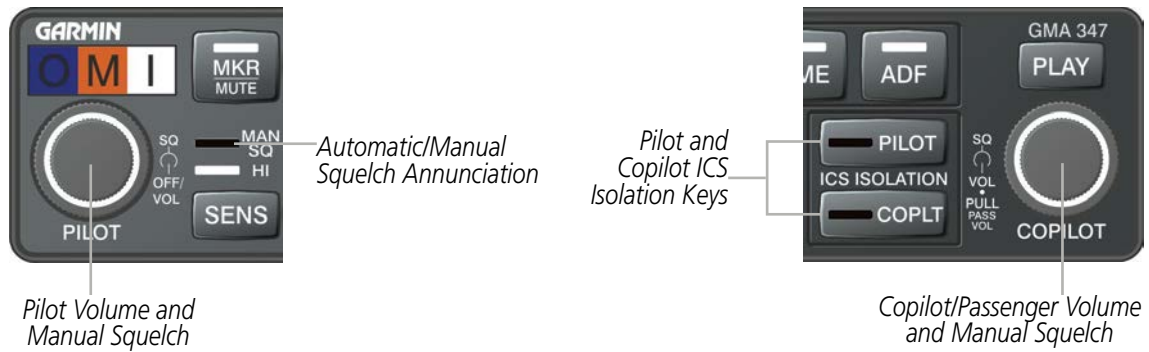

Figure 4-59 Audio Panel Preflight Controls

Setting the Audio Panel during preflight:

- 1) Verify that the PILOT and COPLT Annunciators are extinguished.
- 2) Verify that manual squelch is set to full open.
- 3) Turn the **PILOT** Knob and **COPILOT** Knob fully clockwise. This will set the headset intercom audio level to max volume (least amount of attenuation).
- 4) Adjust radio volume levels (COM, NAV, etc.) to a suitable level.
- 5) Adjust the **PILOT** Knob and **COPILOT** Knob volume to the desired intercom level.
- 6) Reset squelch to automatic, or adjust to the appropriate level manually.

Once this procedure has been completed, the pilot and copilot can change settings, keeping in mind the notes above.

4.7 ABNORMAL OPERATION

Abnormal operation includes equipment failures of the avionics components and failure of associated equipment, including switches and external devices.

AUDIO PANEL FAIL-SAFE OPERATION

If there is a failure of the Audio Panel, a fail-safe circuit connects the pilot's headset and microphone directly to the COM1 transceiver. Audio is not available on the speaker during fail-safe operation.

STUCK MICROPHONE

If the push-to-talk (PTT) Key becomes stuck, the COM transmitter stops transmitting after 35 seconds of continuous operation. An alert appears on the PFD to advise the crew of a stuck microphone.

The MIC Key Annunciator on the Audio Panel flashes as long as the PTT Key remains stuck.

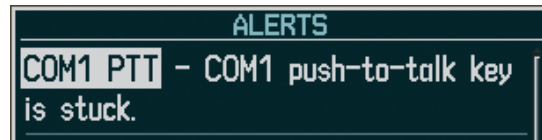

Figure 4-60 Stuck Microphone Alert

COM TUNING FAILURE

In case of a COM system tuning failure, the emergency frequency (121.500 MHz) is automatically tuned in the radio in which the tuning failure occurred. Depending on the failure mode, a red X may appear on the frequency display.



Figure 4-61 COM Tuning Failure

SECTION 5 FLIGHT MANAGEMENT

5.1 INTRODUCTION

Perspective® is an integrated flight, engine, communication, navigation and surveillance system. This section of the Pilot's Guide explains flight management using the system.

The most prominent part of the system are the two full color displays: a Primary Flight Display (PFD) and a Multi Function Display (MFD). The information to successfully navigate the aircraft using the GPS sensors is displayed on the PFD and the MFD. A brief description of the flight management data on the PFD and MFD follows.

Navigation mode indicates which sensor is providing the course data (e.g., GPS, VOR) and the flight plan phase (e.g., Departure (DPRT), Terminal (TERM), Enroute (ENR), Oceanic (OCN), RNAV Approach (LNAV, LNAV+V, L/VNAV, LP, LP+V, or LPV), or Missed Approach (MAPR)). L/VNAV, LP, and LPV approach service levels are only available with SBAS. L/VNAV will be flown as Baro VNAV when SBAS is not available.

The Inset Map is a small version of the MFD Navigation Map and can be displayed in the lower left corner of the PFD. When the system is in reversionary mode, the Inset Map is displayed in the lower right corner. The Inset Map is displayed by pressing the **INSET** Softkey. Pressing the **INSET** Softkey again, then pressing the **OFF** Softkey removes the Inset Map.

The Navigation Map displays aviation data (e.g., airports, VORs, airways, airspaces), geographic data (e.g., cities, lakes, highways, borders), topographic data (map shading indicating elevation), and hazard data (e.g., traffic, terrain, weather). The amount of displayed data can be reduced by pressing the **DCLTR** Softkey. The Navigation Map can be oriented four different ways: North Up (NORTH UP), Track Up (TRK UP), Desired Track Up (DTK UP), or Heading Up (HDG UP).

An aircraft icon is placed on the Navigation Map at the location corresponding to the calculated present position. The aircraft position and the flight plan legs are accurately based on GPS calculations. The basemap upon which these are placed are from a source with less resolution, therefore the relative position of the aircraft to map features is not exact. The leg of the active flight plan currently being flown is shown as a magenta line on the navigation map. The other legs are shown in white.

There are 28 different map ranges available, from 500 feet to 2000 nm. The current range is indicated in the lower right corner of the map and represents the top-to-bottom distance covered by the map. To change the map range on any map, turn the **Joystick** counter-clockwise to zoom in (-, decreasing), or clockwise to zoom out (+, increasing).

The Direct-to Window, the Flight Plan Window, the Procedures Window, and the Nearest Airports Window can be displayed in the lower right corner of the PFD. Details of these windows are discussed in detail later in the section.

- SYSTEM OVERVIEW
- FLIGHT INSTRUMENTS
- EIS
- AUDIO PANEL & CNS
- FLIGHT MANAGEMENT
- HAZARD AVOIDANCE
- AFCS
- ADDITIONAL FEATURES
- APPENDICES
- INDEX



Figure 5-1 GPS Navigation Information on the PFD

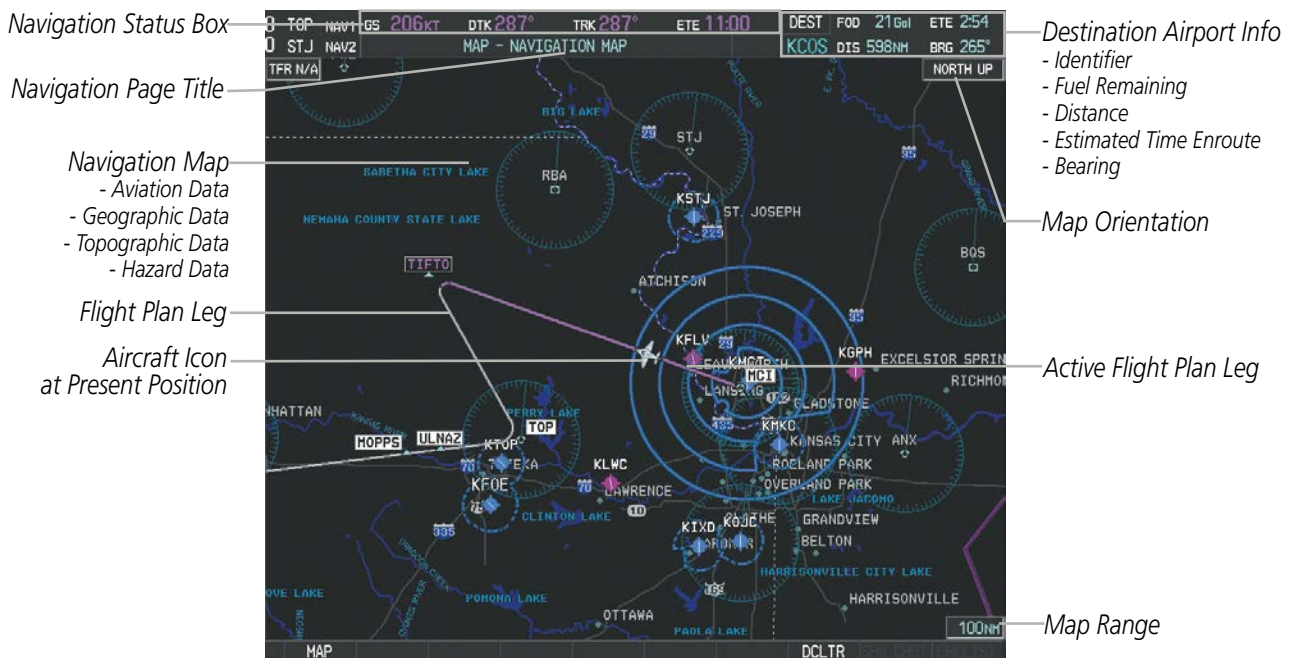

Figure 5-2 GPS Navigation Information on the MFD Navigation Page

NAVIGATION STATUS BOX

The Navigation Status Box located at the top of the PFD contains two fields displaying the following information:



Figure 5-3 PFD Navigation Status Box

- Active flight plan leg (e.g., ‘-D➔ KICT’ or ‘KIXD -D➔ KCOS’) **or** flight plan annunciations (e.g., ‘Turn right to 021° in 8 seconds’)
- Distance (DIS) and Estimate Time Enroute (ETE) to the next waypoint **or** flight plan annunciations (e.g., ‘TOD within 1 minute’)

The symbols used in the PFD status bar are:

Symbol	Description	Symbol	Description
	Active Leg		Left Holding Pattern
	Direct-to		Vector to Final
	Right Procedure Turn		Right DME Arc / Radius to Fix Leg
	Left Procedure Turn		Left DME Arc / Radius to Fix Let
	Right Holding Pattern		

The Navigation Status Box located at the top of the MFD contains four data fields, each displaying one of the following items:

BRG	Bearing	ISA	ISA Relative Temperature
DIS	Distance	LDG	ETA at Final Destination
DTK	Desired Track	MSA	Minimum Safe Altitude
END	Endurance	TAS	True Air Speed
ESA	Enroute Safe Altitude	TKE	Track Angle Error
ETA	Estimated Time of Arrival	TRK	Track
ETE	Estimated Time Enroute	VSR	Vertical Speed Required
FOB	Fuel on Board	XTK	Crosstrack Error
GS	Ground Speed		



Figure 5-4 MFD Navigation Status Box

The navigation information displayed in the four data fields can be selected on the MFD Data Bar Fields Box on the AUX - System Setup Page. The default selections (in order left to right) are GS, DTK, TRK, and ETE.

Changing a field in the MFD Navigation Status Box:

- 1) Select the System Setup Page.
- 2) Push the **FMS** Knob momentarily to activate the flashing cursor.
- 3) Turn the large **FMS** Knob to highlight the desired field number in the MFD Data Bar Fields Box.
- 4) Turn the small **FMS** Knob to display and scroll through the data options list.
- 5) Select the desired data.
- 6) Press the **ENT** Key. Pressing the **DFLTS** Softkey returns all fields to the default setting.

5.2 USING MAP DISPLAYS

Map displays are used extensively in the system to provide situational awareness in flight. Most system maps can display the following information:

- Airports, NAVAIDs, airspaces, airways, land data (highways, cities, lakes, rivers, borders, etc.) with names
- Map range
- Wind direction and speed
- Map orientation
- Icons for enabled map features
- Aircraft icon (representing present position)
- Nav range ring
- Fuel range ring
- Map Pointer information (distance and bearing to pointer, location of pointer, name, and other pertinent information)
- Flight plan legs
- User waypoints
- Track vector
- Topography scale
- Topography data
- Obstacle data

The information in this section applies to the following maps unless otherwise noted:

- All Map Group Pages (MAP)
- All Waypoint Group Pages (WPT)
- AUX - Trip Planning
- All Nearest Group Pages (NRST)
- Flight Plan Pages (FPL)
- Direct-to Window
- PFD Inset Map
- Procedure Loading Pages

MAP ORIENTATION

Maps are shown in one of four different orientation options, allowing flexibility in determining aircraft position relative to other items on the map (north up) or for determining where map items are relative to where the aircraft is going (track up, desired track up, or heading up). The map orientation is shown in the upper right corner of the map.



Figure 5-5 Map Orientation

- North up (NORTH UP) aligns the top of the map display to north (default setting).
- Track up (TRK UP) aligns the top of the map display to the current ground track.
- Desired track up (DTK UP) aligns the top of the map display to the desired course.
- Heading up (HDG UP) aligns the top of the map display to the current aircraft heading.

NOTE: When panning or reviewing active flight plan legs in a non-North Up orientation, the map does not show the map orientation nor the wind direction and speed.

NOTE: Map orientation can only be changed on the Navigation Map Page. All other displays (except the PFD Inset Map) that show navigation data reflect the orientation selected for the Navigation Map Page. The PFD Inset Map is always Heading Up (if heading is invalid, then track up).

Changing the Navigation Map orientation:

- 1) With the Navigation Map Page displayed, press the **MENU** Key. The cursor flashes on the 'Map Setup' option.



Figure 5-6 Navigation Map Page Menu Window

- 2) Press the **ENT** Key to display the Map Setup Window.
- 3) Turn the large **FMS** Knob, or press the **ENT** Key once, to select the 'ORIENTATION' field.
- 4) Turn the small **FMS** Knob to select the desired orientation.
- 5) Press the **ENT** Key to select the new orientation.
- 6) Push the **FMS** Knob to return to the base page.

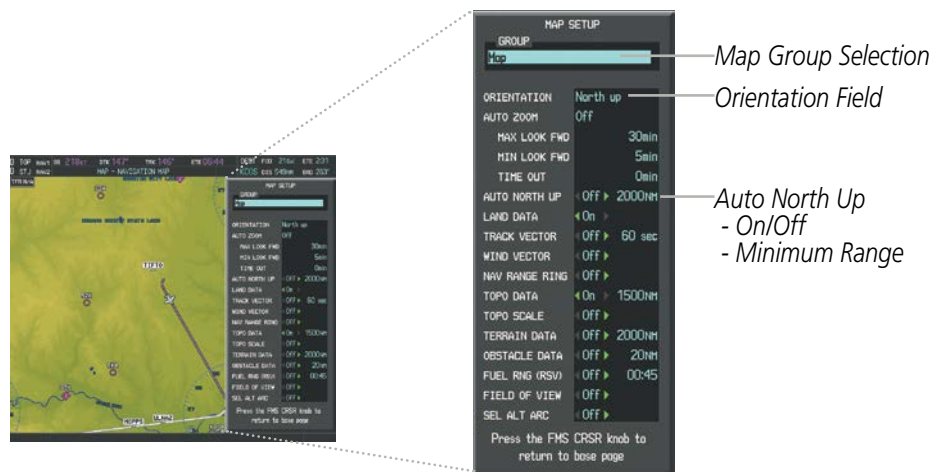

Figure 5-7 Map Setup Menu Window - Map Group

The map can be configured to switch automatically to a north up orientation when the map range reaches a minimum range.

Enabling/disabling Auto North Up and selecting the minimum switching range:

- 1) Press the **MENU** Key with the Navigation Map Page displayed. The cursor flashes on the 'Map Setup' option.
- 2) Press the **ENT** Key. The Map Setup Menu is displayed.
- 3) Select the 'Map' group.
- 4) Press the **ENT** Key.
- 5) Highlight the 'AUTO NORTH UP' field.
- 6) Select 'On' or 'Off' using the small **FMS** Knob.
- 7) Press the **ENT** Key to accept the selected option. The flashing cursor highlights the range field.
- 8) Use the small **FMS** Knob to select the desired range.
- 9) Press the **ENT** Key to accept the selected option.
- 10) Push the **FMS** Knob to return to the Navigation Map Page.

MAP RANGE

There are 28 different map ranges available, from 500 feet to 2000 nm. The current range is indicated in the lower right corner of the map and represents the top-to-bottom distance covered by the map. When the map range is decreased to a point that exceeds the capability of Perspective to accurately represent the map, a magnifying glass icon is shown to the left of the map range. To change the map range turn the **Joystick** counter-clockwise to decrease the range, or clockwise to increase the range.

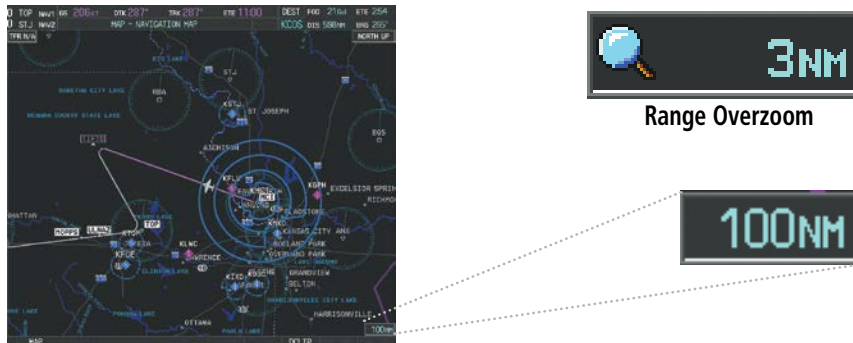

Figure 5-8 Map Range

AUTO ZOOM

Auto zoom allows the system to change the map display range to the smallest range clearly showing the active waypoint. Auto zoom can be overridden by adjusting the range with the Joystick, and remains until the active waypoint changes, a terrain or traffic alert occurs, the aircraft takes off, or the manual override times out (timer set on Map Setup Window). Auto zoom is suspended while the map pointer is active.

If a terrain caution or warning occurs, all navigation maps automatically adjust to the smallest map range clearly showing the potential impact areas. If a new traffic advisory alert occurs, any map page capable of displaying traffic advisory alerts automatically adjusts to the smallest map range clearly showing the traffic advisory. When terrain or traffic alerts clear, the map returns to the previous auto zoom range based on the active waypoint.

The auto zoom function can be turned on or off independently for the PFDs and MFD. Control of the ranges at which the auto zoom occurs is done by setting the minimum and maximum 'look forward' times (set on the Map Setup Window for the Map Group). These settings determines the minimum and maximum distance to display based upon the aircraft's ground speed.

- Waypoints that are long distances apart cause the map range to increase to a point where many details on the map are decluttered. If this is not acceptable, lower the maximum look ahead time to a value that limits the auto zoom to an acceptable range.
- Waypoints that are very short distances apart cause the map range to decrease to a point where situational awareness may not be what is desired. Increase the minimum look ahead time to a value that limits the auto zoom to a minimum range that provides acceptable situational awareness.
- Flight plans that have a combination of long and short legs cause the range to increase and decrease as waypoints sequence. To avoid this, auto zoom can be disabled or the maximum/minimum times can be adjusted.
- The 'time out' time (configurable on the Map Setup Page for the Map Group) determines how long auto zoom is overridden by a manual adjustment of the range knob. At the expiration of this time, the auto zoom range is restored. Setting the 'time out' value to zero causes the manual override to never time out.
- When the maximum 'look forward' time is set to zero, the upper limit becomes the maximum range available (2000 nm).
- When the minimum 'look forward' time is set to zero, the lower limit becomes 1.5 nm.

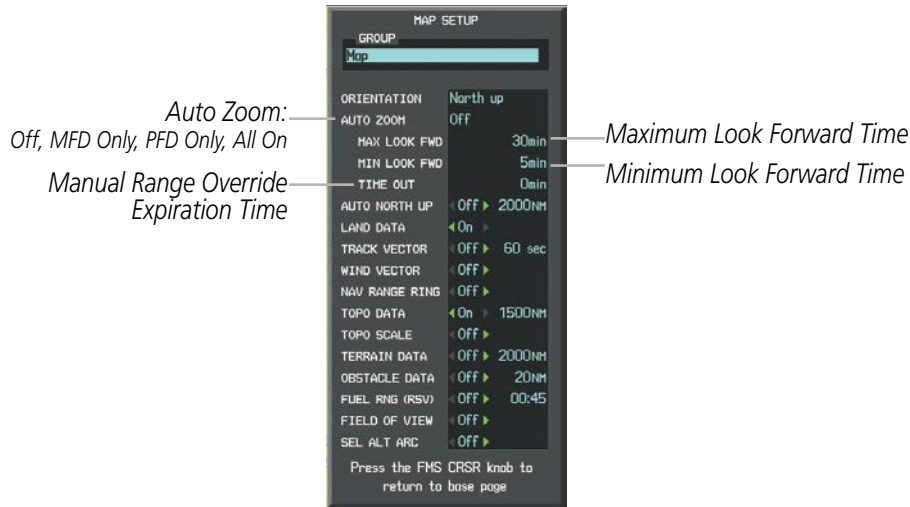

Figure 5-9 Map Setup Menu Window - Map Group, Auto Zoom

Configuring automatic zoom:

- 1) Press the **MENU** Key with the Navigation Map Page displayed. The cursor flashes on the 'Map Setup' option.
- 2) Press the **ENT** Key. The Map Setup Menu is displayed.
- 3) Select the 'Map' group.
- 4) Press the **ENT** Key.
- 5) Highlight the 'AUTO ZOOM' field.
- 6) Select 'Off', 'MFD Only', 'PFD Only', or 'ALL On'.
- 7) Press the **ENT** Key to accept the selected option. The flashing cursor highlights the 'MAX LOOK FWD' field. Times are from zero to 999 minutes.
- 8) Use the **FMS** Knobs to set the time. Press the **ENT** Key.
- 9) Repeat step 8 for 'MIN LOOK FWD' (zero to 99 minutes) and 'TIME OUT' (zero to 99 minutes).
- 10) Push the **FMS** Knob to return to the Navigation Map Page.

MAP PANNING

Map panning allows the pilot to:

- View parts of the map outside the displayed range without adjusting the map range by panning the map (**Joystick**)
- Highlight and select locations on the map (**Joystick**)
- Display an information screen for a selected airport, NAVAID (VOR, Intersection, NDB), user waypoint, or airspace (**ENT Key**)
- Graphically create user waypoints (**ENT Key**)
- Measure the bearing and distance from the aircraft present position to any location on the navigation map, or between any two points on the navigation map (**MENU Key**)
- Review airspace, obstacle and airway information in a pop-up window on the navigation map (**Joystick**)

When the panning function is selected by pressing the **Joystick**, the Map Pointer flashes on the map display. A window also appears at the top of the map display showing the latitude/longitude position of the pointer, the bearing and distance to the pointer from the aircraft's present position, and the elevation of the land at the position of the pointer.

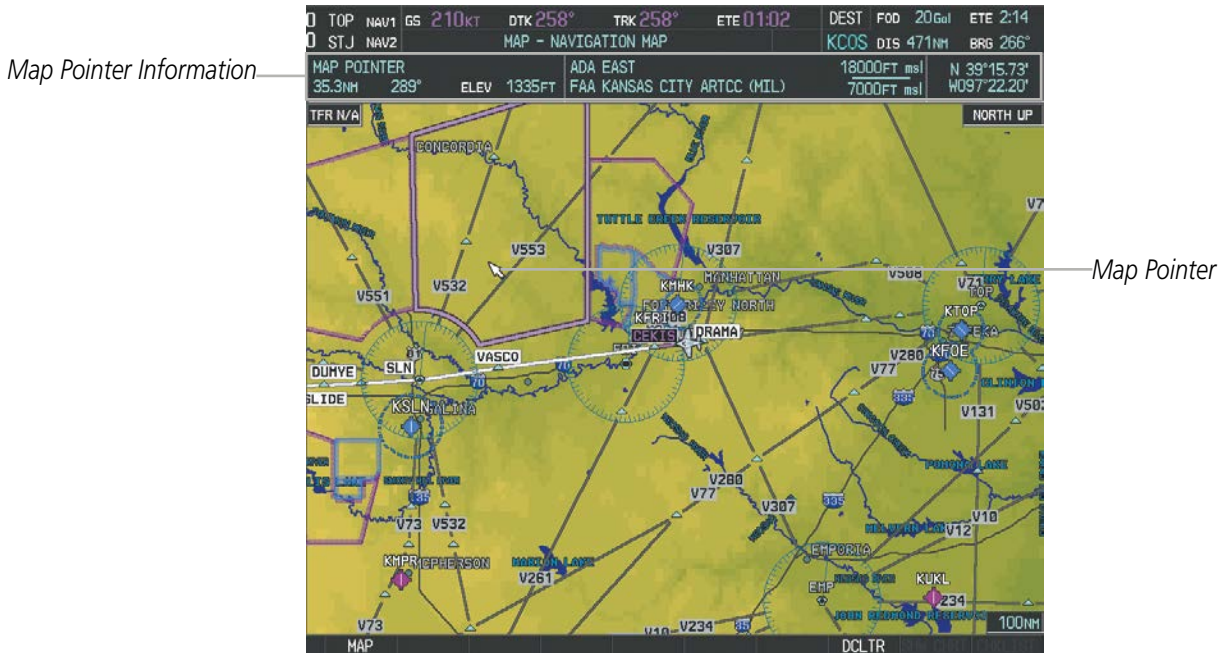

Figure 5-10 Navigation Map - Map Pointer Activated



NOTE: The map is normally centered on the aircraft's position. If the map has been panned and there has been no pointer movement for about 60 seconds, the map reverts back to centered on the aircraft position and the flashing pointer is removed.

SYSTEM OVERVIEW

FLIGHT INSTRUMENTS

EIS

AUDIO PANEL & CNS

FLIGHT MANAGEMENT

HAZARD AVOIDANCE

AFCS

ADDITIONAL FEATURES

APPENDICES

INDEX

When the Map Pointer is placed on an object, the name of the object is highlighted (even if the name was not originally displayed on the map). When any map feature or object is selected on the map display, pertinent information is displayed.

Information about Point of Interest



Map Pointer on POI

Figure 5-11 Navigation Map - Map Pointer on Point of Interest

When the Map Pointer crosses an airspace boundary, the boundary is highlighted and airspace information is shown at the top of the display. The information includes the name and class of airspace, the ceiling in feet above Mean Sea Level (MSL), and the floor in feet MSL.

Information about Airspace



Map Pointer on Airspace

Figure 5-12 Navigation Map - Map Pointer on Airspace

Panning the map:

- 1) Press the **Joystick** to display the Map Pointer.
- 2) Move the **Joystick** to move the Map Pointer around the map.
- 3) Press the **Joystick** to remove the Map Pointer and recenter the map on the aircraft's current position.

Reviewing information for an airport, NAVAID, or user waypoint:

- 1) Place the Map Pointer on a waypoint.
- 2) Press the **ENT** Key to display the Waypoint Information Page for the selected waypoint.
- 3) Press the **GO BACK** Softkey, the **CLR** Key, or the **ENT** Key to exit the Waypoint Information Page and return to the Navigation Map showing the selected waypoint.

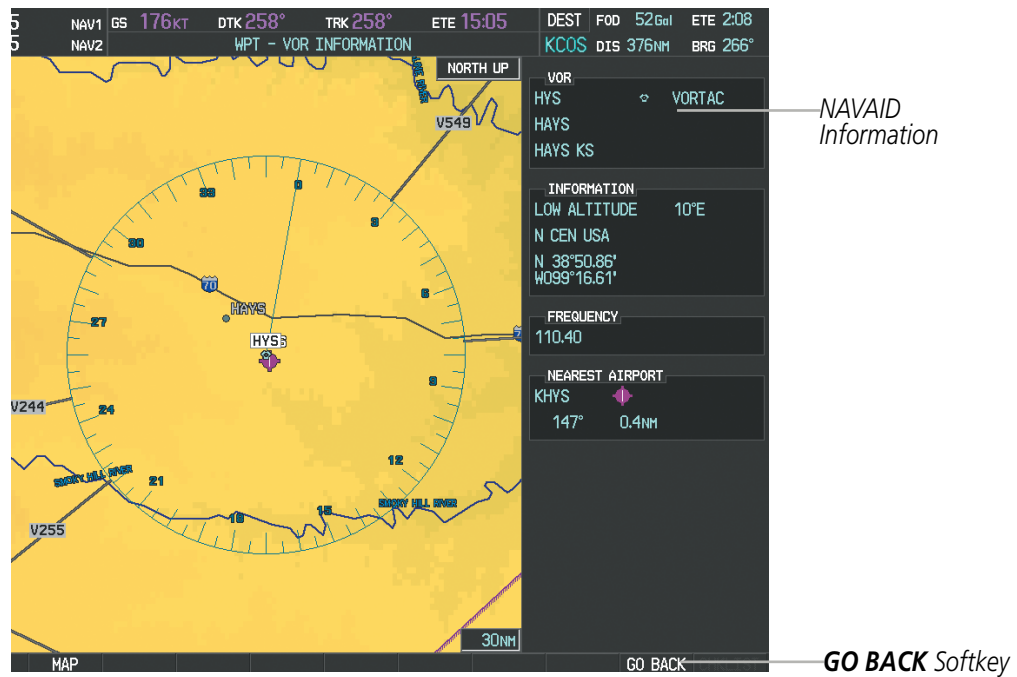

Figure 5-13 Navigation Map - Information Window - NAVAID

Viewing airspace information for a special-use or controlled airspace:

- 1) Place the Map Pointer on an open area within the boundaries of an airspace.
- 2) Press the **ENT** Key to display an options menu.
- 3) 'Review Airspaces' should already be highlighted, if not select it. Press the **ENT** Key to display the Airspace Information Page for the selected airspace.
- 4) Press the **CLR** or **ENT** Key to exit the Airspace Information Page.



Figure 5-14 Navigation Map - Information Window - Airspace

MEASURING BEARING AND DISTANCE

Distance and bearing can be measured on a navigation map using the **Joystick**. Measurement can be from the aircraft's present position to any point, or between any two points. The bearing and distance tool displays a dashed Measurement Line and a Measure Pointer to aid in graphically identifying the points to measure. Latitude/Longitude, distance, bearing and elevation data of the Measure Pointer is provided in a window at the top left of the map.

Measuring bearing and distance between any two points:

- 1) Press the **MENU** Key (with the Navigation Map Page displayed).
- 2) Highlight the 'Measure Bearing/Distance' field.
- 3) Press the **ENT** Key. A Measure Pointer is displayed on the map at the aircraft's present position.
- 4) Move the **Joystick** to place the reference pointer at the desired location. The bearing and distance are displayed at the top of the map. Elevation at the current pointer position is also displayed. Pressing the **ENT** Key changes the starting point for measuring.
- 5) To exit the Measure Bearing/Distance option, press the **Joystick**; or select 'Stop Measuring' from the Page Menu and press the **ENT** Key.



Figure 5-15 Navigation Map - Measuring Bearing and Distance

TOPOGRAPHY

All navigation maps can display various shades of topography colors representing land elevation, similar to aviation sectional charts. Topographic data can be displayed or removed as described in the following procedures. Topographic data can also be displayed on the selectable profile map at the bottom of the navigation map.

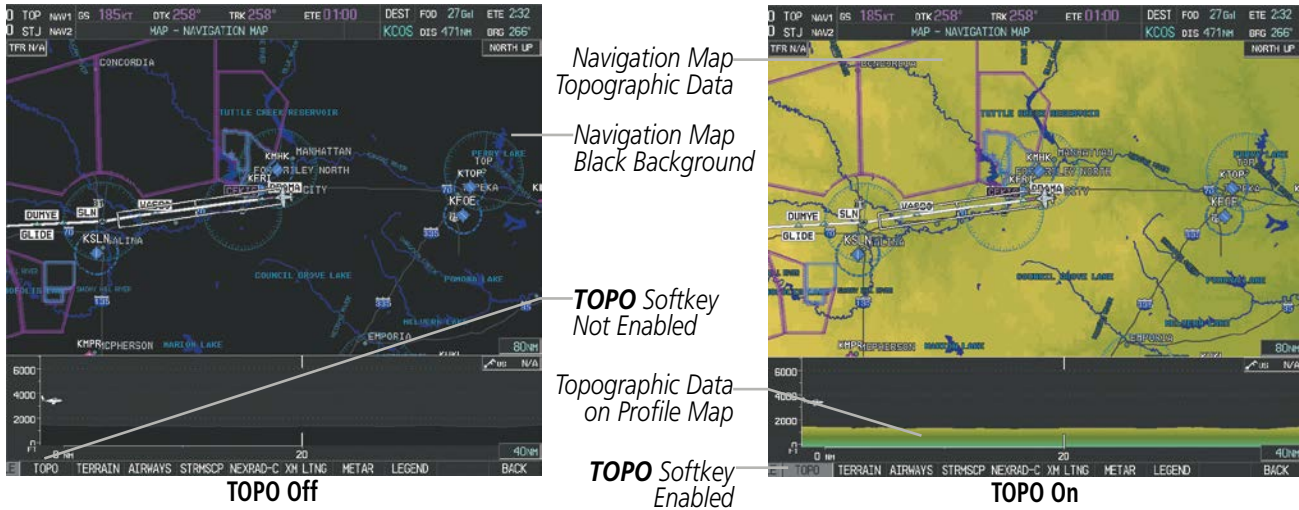

Figure 5-16 Navigation Map - Topographic Data

Displaying/removing topographic data on all pages displaying navigation maps:

- 1) Press the **MAP** Softkey (the **INSET** Softkey for the PFD Inset Map).
- 2) Press the **TOPO** Softkey.
- 3) Press the **TOPO** Softkey again to remove topographic data from the Navigation Map. When topographic data is removed from the page, all navigation data is presented on a black background.

Displaying/removing topographic data (TOPO DATA) using the Navigation Map Page Menu:

- 1) Press the **MENU** Key with the Navigation Map Page displayed. The cursor flashes on the 'Map Setup' option.
- 2) Press the **ENT** Key. The Map Setup Menu is displayed.
- 3) Select the 'Map' group.
- 4) Press the **ENT** Key.
- 5) Highlight the 'TOPO DATA' field.
- 6) Select 'On' or 'Off'.
- 7) Push the **FMS** Knob to return to the Navigation Map Page.

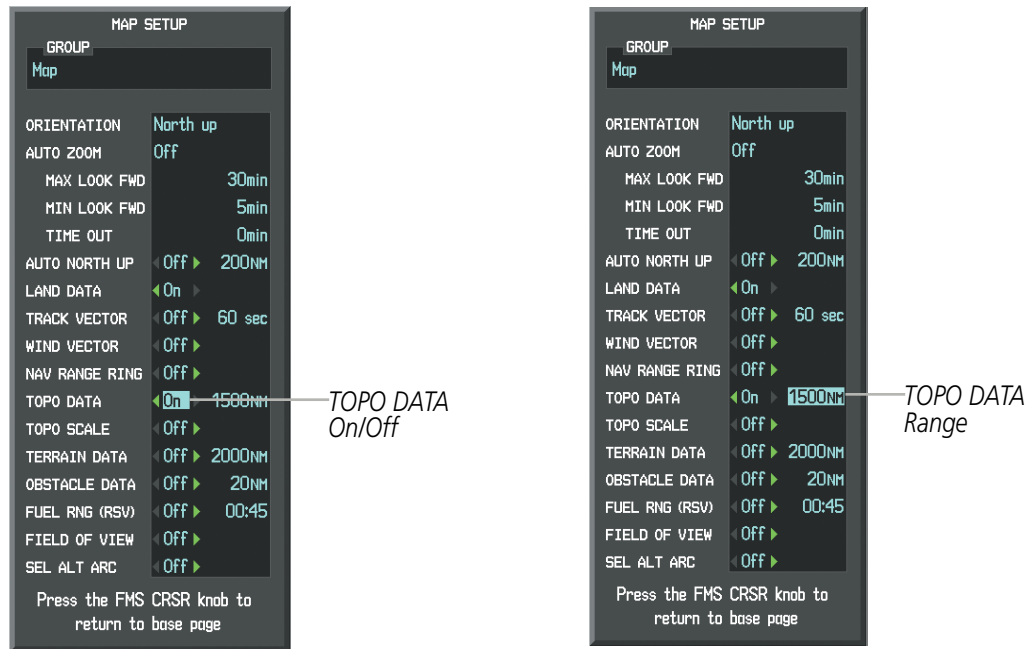

Figure 5-17 Navigation Map Setup Menu - TOPO DATA Setup

The topographic data range is the maximum map range on which topographic data is displayed.



NOTE: Since the PFD Inset Map is much smaller than the MFD navigation maps, items are removed on the PFD Inset Map two range levels smaller than the range selected in the Map Setup pages (e.g., a setting of 100 nm removes the item at ranges above 100 nm on MFD navigation maps, while the PFD Inset Map removes the same item at 50 nm).

Selecting a topographical data range (TOPO DATA):

- 1) Press the **MENU** Key with the Navigation Map Page displayed. The cursor flashes on the 'Map Setup' option.
- 2) Press the **ENT** Key. The Map Setup Menu is displayed.
- 3) Select the 'Map' group.
- 4) Press the **ENT** Key.
- 5) Highlight the 'TOPO DATA' range field. TOPO ranges are from 500 ft to 2000 nm.
- 6) To change the TOPO range setting, turn the small **FMS** Knob to display the range list.
- 7) Select the desired range using the small **FMS** Knob.
- 8) Press the **ENT** Key.
- 9) Push the **FMS** Knob to return to the Navigation Map Page.

In addition, the Navigation Map can display a topographic scale (located in the lower right hand side of the map) showing a scale of the terrain elevation and current elevation values.

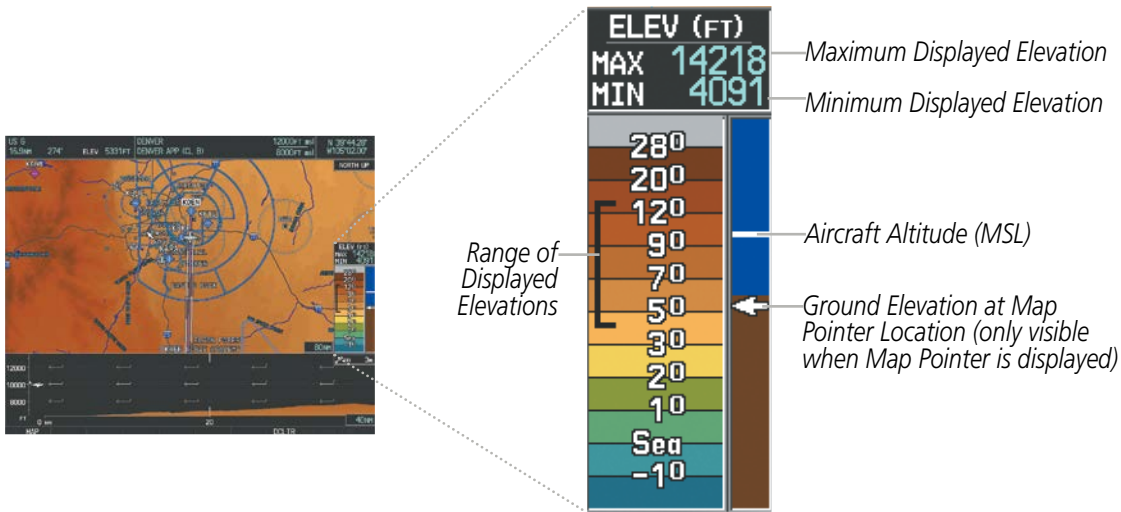

Figure 5-18 Navigation Map - TOPO SCALE

Displaying/removing the topographic scale (TOPO SCALE):

- 1) Press the **MENU** Key with the Navigation Map Page displayed. The cursor flashes on the 'Map Setup' option.
- 2) Press the **ENT** Key. The Map Setup Menu is displayed.
- 3) Select the 'Map' group and select the **ENT** Key.
- 4) Highlight the 'TOPO SCALE' field.
- 5) Select 'On' or 'Off'.
- 6) Push the **FMS** Knob to return to the Navigation Map Page.

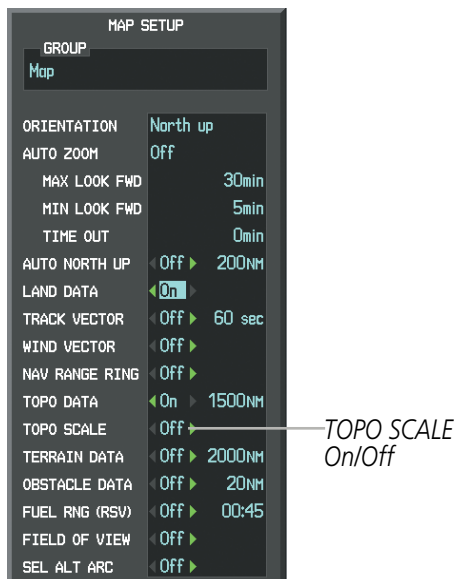

Figure 5-19 Navigation Map Setup Menu - TOPO SCALE Setup

MAP SYMBOLS

This section discusses the types of land and aviation symbols that can be displayed. Each listed type of symbol can be turned on or off, and the maximum range to display each symbol can be set. The decluttering of the symbols from the map using the **DCLTR** Softkey is also discussed.

LAND SYMBOLS

The following items are configured on the land menu:













Land Symbols <i>(Text label size can be None, Small, Medium (Med), or Large (Lrg))</i>	Symbol	Default Range (nm)	Maximum Range (nm)
Latitude/Longitude (LAT/LON)		Off	2000
Highways and Roads			
Interstate Highway (FREEWAY)		300	800
International Highway (FREEWAY)		300	800
US Highway (NATIONAL HWY)		30	80
State Highway (LOCAL HWY)		15	30
Local Road (LOCAL ROAD)	N/A	8	15
Railroads (RAILROAD)		15	30
LARGE CITY (> 200,000)		800	1500
MEDIUM CITY (> 50,000)		100	200
SMALL CITY (> 5,000)		20	50
States and Provinces (STATE/PROV)		800	1500
Rivers and Lakes (RIVER/LAKE)		200	500
USER WAYPOINT		150	300

Table 5-1 Land Symbol Information

AVIATION SYMBOLS

The following items are configured on the aviation menu:

Aviation Symbols <i>(Text label size can be None, Small, Medium (Med), or Large (Lrg))</i>	Symbol	Default Range (nm)	Maximum Range (nm)
Active Flight Plan Leg (ACTIVE FPL)		2000	2000
Non-active Flight Plan Leg (ACTIVE FPL)		2000	2000
Active Flight Plan Waypoint (ACTIVE FPL WPT)	See Airports, NAVAIDs	2000	2000
Large Airports (LARGE APT)		200	500
Medium Airports (MEDIUM APT)		150	300
Small Airports (SMALL APT)		50	100
Taxiways (SAFETAXI)	See Additional Features	3	20
Runway Extension (RWY EXTENSION)	N/A	Off	100
Intersection (INT WAYPOINT)		15	30
Non-directional Beacon (NDB WAYPOINT)		15	30
VOR (VOR WAYPOINT)		150	300
VRP (VRP WAYPOINT)		15	30
Class B Airspace/TMA (CLASS B/TMA)		200	500
Class C Airspace/TCA (CLASS C/TCA)		200	500
Class D Airspace (CLASS D)		150	300
Alert/Prohibited/Restricted/ Warning Area (RESTRICTED)		200	500
Military Operations Area [MOA(MILITARY)]		200	500
Other/Air Defense Interdiction Zone (OTHER/ADIZ)		200	500
Temporary Flight Restriction (TFR)		500	2000

Table 5-2 Aviation Symbol Information

SYMBOL SETUP

All pages with maps can display land symbols (roads, lakes, borders, etc). Land symbols can be removed totally (turned off).

Displaying/removing all land symbols:

- 1) Press the **MENU** Key with the Navigation Map Page displayed. The Page Menu is displayed and the cursor flashes on the 'Map Setup' option.
- 2) Press the **ENT** Key. The Map Setup Group Menu is displayed and the cursor flashes on the 'Map' option.
- 3) Highlight the 'LAND DATA' field.
- 4) Select 'On' or 'Off'.
- 5) Push the **FMS** Knob to return to the Navigation Map Page.

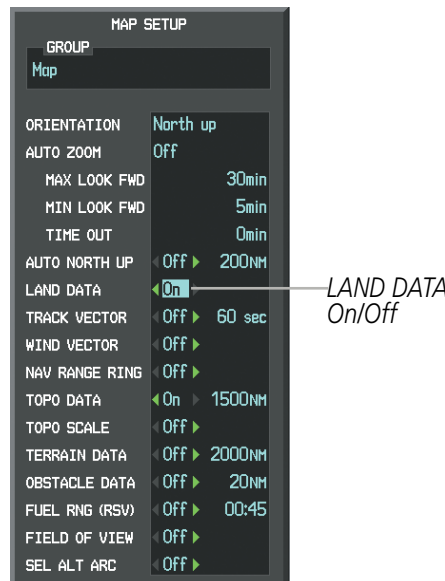

Figure 5-20 Navigation Map Setup Menu - LAND DATA Setup

The label size (TEXT) sets the size at which labels appear on the display (none, small, medium, and large). The range (RNG) sets the maximum range at which items appear on the display.

Selecting a 'Land' or 'Aviation' group item text size and range:

- 1) Press the **MENU** Key with the Navigation Map Page displayed. The cursor flashes on the 'Map Setup' option.
- 2) Press the **ENT** Key. The Map Setup Menu is displayed.
- 3) Select the 'Land' or 'Aviation' group.
- 4) Press the **ENT** Key. The cursor flashes on the first field.
- 5) Select the desired land option.
- 6) Select the desired text size.
- 7) Press the **ENT** Key to accept the selected size.

- 8) Select the desired range.
- 9) Press the **ENT** Key to accept the selected range.
- 10) Push the **FMS** Knob to return to the Navigation Map Page.

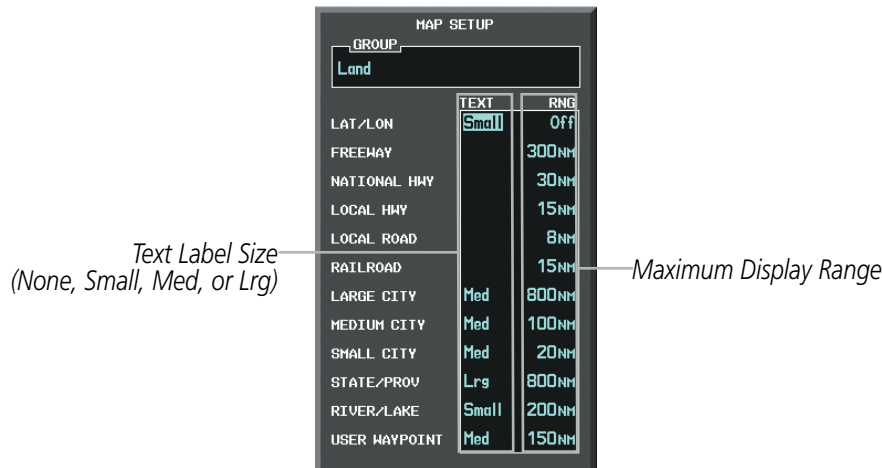

Figure 5-21 Navigation Map Setup Menu - LAND GROUP Setup

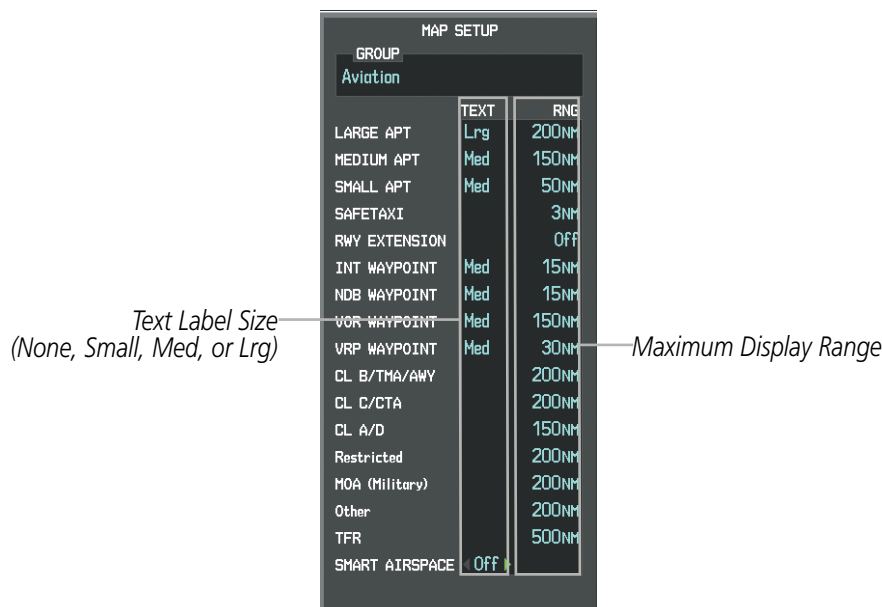

Figure 5-22 Navigation Map Setup Menu - AVIATION GROUP Setup



NOTE: Since the PFD Inset Map is much smaller than the MFD navigation maps, items are removed on the PFD Inset Map two range levels smaller than the range selected in the Map Setup pages (e.g., a setting of 100 nm removes the item at ranges above 100 nm on MFD navigation maps, while the PFD Inset Map removes the same item at 50 nm).

MAP DECLUTTER

The declutter feature allows the pilot to progressively step through four levels of removing map information. The declutter level is displayed in the **DCLTR** Softkey and next to the Declutter Menu Option.

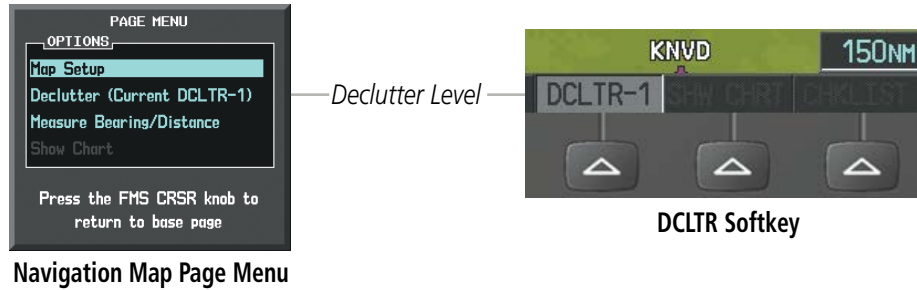

Figure 5-23 Navigation Map - Declutter Level Indications

Decluttering the map:

Press the **DCLTR** Softkey with the Navigation Map Page displayed. The current declutter level is shown. With each softkey press, another level of map information is removed.

Or:

- 1) Press the **MENU** Key with the Navigation Map Page displayed.
- 2) Select 'Declutter'. The current declutter level is shown.
- 3) Press the **ENT** Key.

Decluttering the PFD Inset Map:

- 1) Press the **INSET** Softkey.
- 2) Press the **DCLTR** Softkey. The current declutter level is shown. With each selection, another level of map information is removed.

The following table lists the items that are decluttered at each map detail level. The 'X' represents map items decluttered for each level of detail.

Item	Declutter-1	Declutter-2	Declutter-3
Data Link Radar Precipitation			X
Data Link Lightning			X
Graphical METARs			X
Airports			X
Safe Taxi			X
Runway Labels			X
TFRs			X
Restricted			X
MOA (Military)			X
VRPs		X	X
User Waypoints		X	X
Latitude/Longitude Grid		X	X
NAVAIDs (does not declutter if used to define airway)		X	X
Intersections (does not declutter if used to define airway)		X	X
Class B Airspaces/TMA		X	X
Class C Airspaces/TCA		X	X
Class D Airspaces		X	X
Other Airspaces/ADIZ		X	X
Obstacles		X	X
Cities	X	X	X
Roads	X	X	X
Railroads	X	X	X
State/Province Boundaries	X	X	X

Table 5-3 Navigation Map Items Decluttered for each Detail Level

AIRWAYS

This airways discussion is based upon the North American airway structure. The airway structure in places other than North America vary by location, etc. and are not discussed in this book. Low Altitude Airways (Victor Airways or T-Routes) start 1,200 feet above ground level (AGL) and extend up to 18,000 feet mean sea level (MSL). Low Altitude Airways are designated with a “V” or a “T” before the airway number.

High Altitude Airways (Jet Routes or Q-Routes) start at 18,000 feet MSL and extend upward to 45,000 feet MSL. High Altitude Airways are designated with a “J” or a “Q” before the airway number.

Low Altitude Airways are drawn in gray (the same shade used for roads). High Altitude Airways are drawn in green. When both types of airways are displayed, High Altitude Airways are drawn on top of Low Altitude Airways.

When airways are selected for display on the map, the airway waypoints (VORs, NDBs and Intersections) are also displayed.

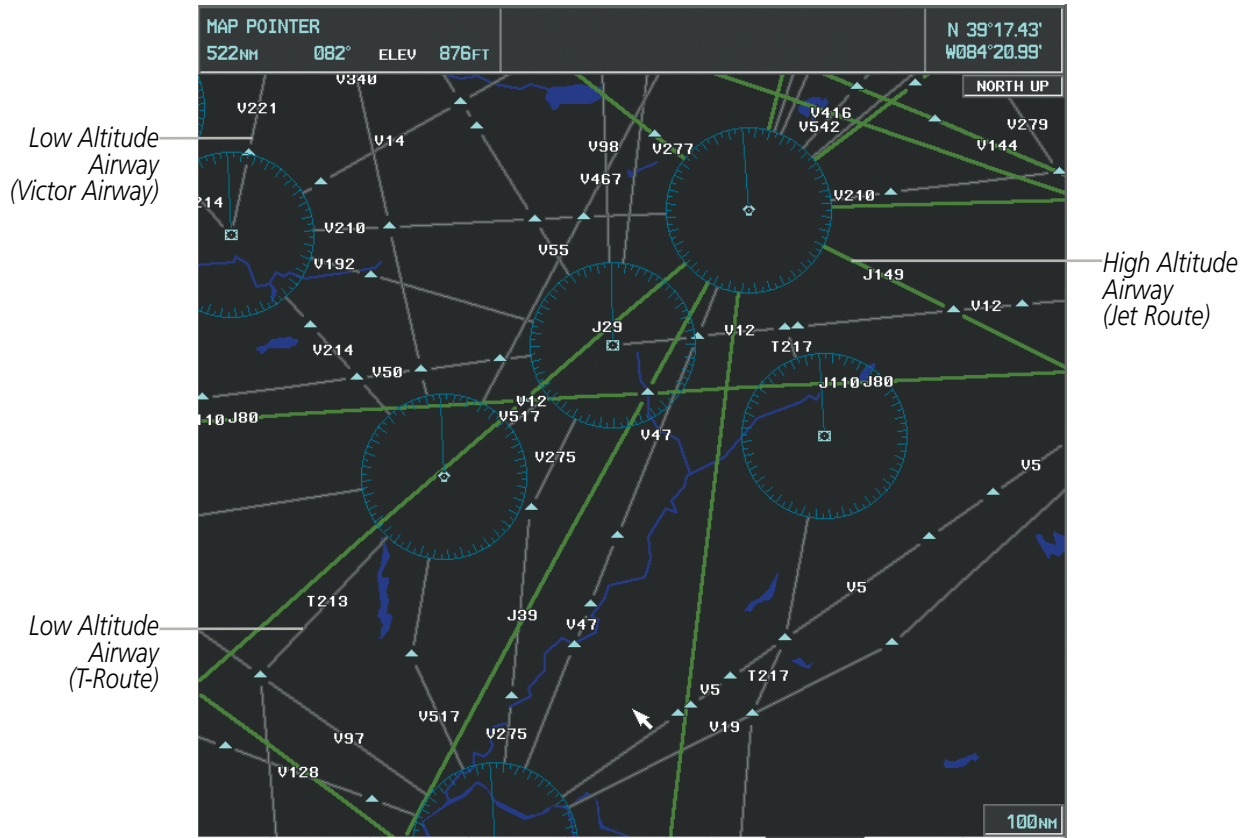

Figure 5-24 Airways on MFD Navigation Page

Airways may be displayed on the map at the pilot's discretion using either a combination of **AIRWAYS** Softkey presses, or menu selections using the **MENU** Key from the Navigation Map Page. The Airway range can also be programmed to only display Airways on the MFD when the map range is at or below a specific number.

Displaying/removing airways:

- 1) Press the **MAP** Softkey.
- 2) Press the **AIRWAYS** Softkey. Both High and Low Altitude Airways are displayed (AIRWAY ON).
- 3) Press the softkey again to display Low Altitude Airways only (AIRWAY LO).
- 4) Press the softkey again to display High Altitude Airways only (AIRWAY HI).
- 5) Press the softkey again to remove High Altitude Airways. No airways are displayed (AIRWAYS).

Or:

- 1) Press the **MENU** Key with the Navigation Map Page displayed. The cursor flashes on the 'Map Setup' option.
- 2) Press the **ENT** Key. The Map Setup Menu is displayed.
- 3) Turn the small **FMS** Knob to select the 'Airways' group, and press the **ENT** Key.
- 4) Turn the large **FMS** Knob to highlight the 'AIRWAYS' field.
- 5) Turn the **FMS** Knob to select 'Off', 'All', 'LO Only', or 'HI Only', and press the **ENT** Key.
- 6) Push the **FMS** Knob to return to the Navigation Map Page.

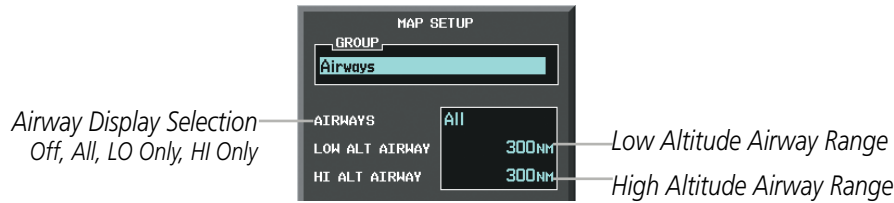

Figure 5-25 Navigation Map Setup Menu - AIRWAYS Setup

The airway range is the maximum map range on which airways are displayed.

Selecting an airway range (LOW ALT AIRWAY or HI ALT AIRWAY):

- 1) Press the **MENU** Key with the Navigation Map Page displayed. The cursor flashes on the 'Map Setup' option.
- 2) Press the **ENT** Key. The Map Setup Menu is displayed.
- 3) Turn the small **FMS** Knob to select the 'Airways' group, and press the **ENT** Key.
- 4) Highlight the 'LOW ALT AIRWAY' or 'HI ALT AIRWAY' range field.
- 5) To change the range setting, turn the small **FMS** Knob to display the range list.
- 6) Select the desired range using the small **FMS** Knob.
- 7) Press the **ENT** Key.
- 8) Push the **FMS** Knob to return to the Navigation Map Page.

The following range items are configurable on the airways menu:

Airway Type	Symbol	Default Range (nm)	Maximum Range (nm)
Low Altitude Airway (LOW ALT AIRWAY)		200	500
High Altitude Airway (HI ALT AIRWAY)		300	500

Table 5-4 Airway Range Information

TRACK VECTOR

The Navigation Map can display a track vector that is useful in minimizing track angle error. The track vector is a solid cyan line segment extended to a predicted location. The track vector look-ahead time is selectable (30 sec, 60 sec (default), 2 min, 5 min, 10 min, 20 min) and determines the length of the track vector. The track vector shows up to 90 degrees of a turn for the 30 and 60 second time settings. It is always a straight line for the 2 min, 5 min, 10 min and 20 min settings.

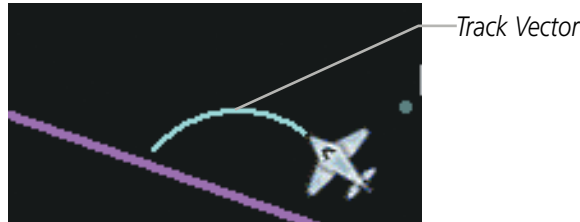

Figure 5-26 Navigation Map -Track Vector

Displaying/removing the track vector:

- 1) Press the **MENU** Key with the Navigation Map Page displayed. The cursor flashes on the 'Map Setup' option.
- 2) Press the **ENT** Key. The Map Setup Menu is displayed.
- 3) Select the 'Map' group.
- 4) Press the **ENT** Key.
- 5) Highlight the 'TRACK VECTOR' field.
- 6) Select 'On' or 'Off'. Press the **ENT** Key to accept the selected option. The flashing cursor highlights the look ahead time field. Use the **FMS** Knob to select the desired time. Press the **ENT** Key.
- 7) Push the **FMS** Knob to return to the Navigation Map Page.

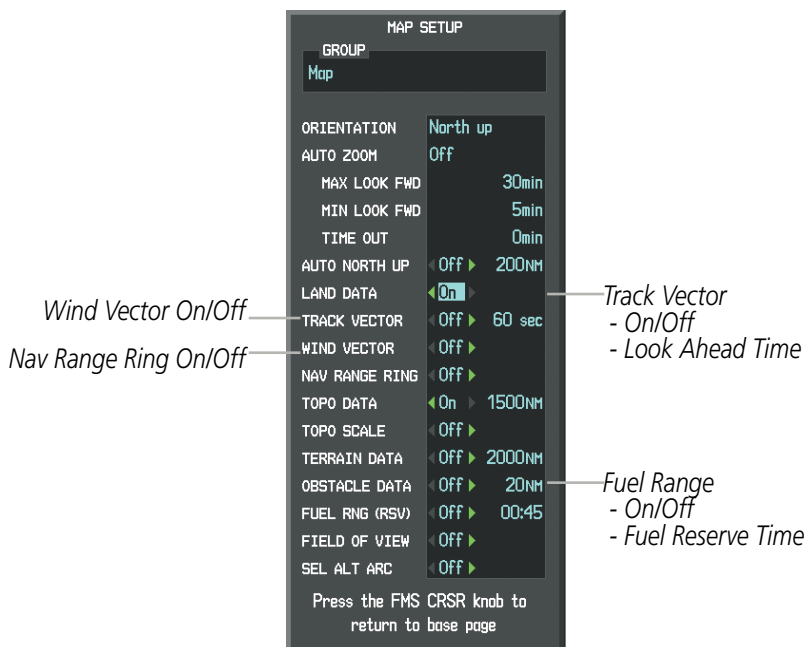

Figure 5-27 Navigation Map Setup Menu -TRACK VECTOR, WIND VECTOR, NAV RANGE RING, FUEL RANGE RING Setup

WIND VECTOR

The map displays a wind vector arrow in the upper right-hand portion of the screen. Wind vector information is displayed as a white arrow pointing in the direction in which the wind is moving for wind speeds greater than or equal to 1 kt.



Figure 5-28 Navigation Map - Wind Vector



NOTE: The wind vector is not displayed until the aircraft is moving. It is not displayed on the Waypoint Information pages.

Displaying/removing the wind vector:

- 1) Press the **MENU** Key with the Navigation Map Page displayed. The cursor flashes on the 'Map Setup' option.
- 2) Press the **ENT** Key. The Map Setup Menu is displayed.
- 3) Select the 'Map' group.
- 4) Press the **ENT** Key.
- 5) Highlight the 'WIND VECTOR' field.
- 6) Select 'On' or 'Off'.
- 7) Push the **FMS** Knob to return to the Navigation Map Page.

NAV RANGE RING

The Nav Range Ring shows the direction of travel (ground track) on a rotating compass card. The range is determined by the map range. The range is 1/4 of the map range (e.g., 37.5 nm on a 150 nm map).

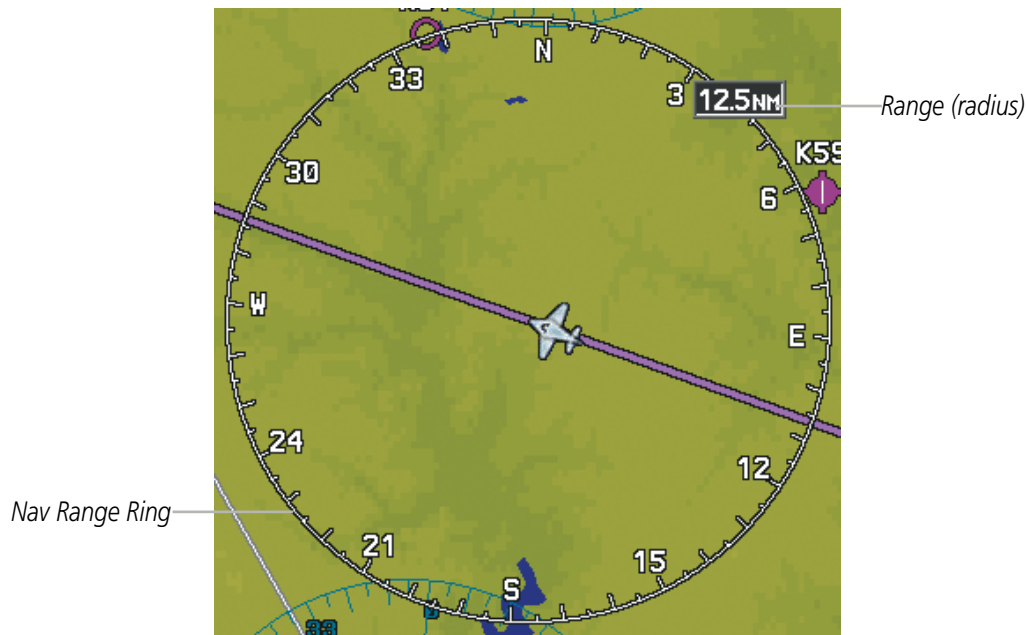

Figure 5-29 Navigation Map - Nav Range Ring



NOTE: The Nav Range Ring is not displayed on the Waypoint Information pages, Nearest pages, or Direct-to Window map.

Displaying/removing the Nav Range Ring:

- 1) Press the **MENU** Key with the Navigation Map Page displayed. The cursor flashes on the 'Map Setup' option.
- 2) Press the **ENT** Key. The Map Setup Menu is displayed.
- 3) Select the 'Map' group.
- 4) Press the **ENT** Key.
- 5) Highlight the 'NAV RANGE RING' field.
- 6) Select 'On' or 'Off'.
- 7) Push the **FMS** Knob to return to the Navigation Map Page.



NOTE: The Nav Range Ring is referenced to either magnetic or true north, based on the selection on the AUX - System Setup Page.

FUEL RANGE RING

The map can display a fuel range ring which shows the remaining flight distance. A dashed green circle indicates the selected range to reserve fuel. A solid green circle indicates the total endurance range. If only reserve fuel remains, the range is indicated by a solid amber circle.

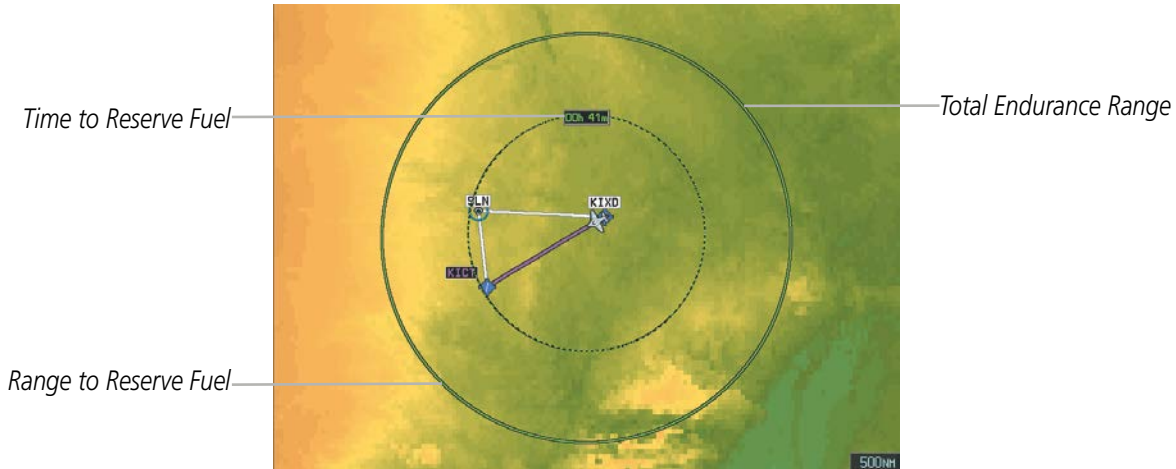

Figure 5-30 Navigation Map - Fuel Range Ring

Displaying/removing the fuel range ring and selecting a fuel range time:

- 1) Press the **MENU** Key with the Navigation Map Page displayed. The cursor flashes on the 'Map Setup' option.
- 2) Press the **ENT** Key. The Map Setup Menu is displayed.
- 3) Select the 'Map' group.
- 4) Press the **ENT** Key.
- 5) Highlight the 'FUEL RNG (RSV)' field.
- 6) Select 'On' or 'Off'.
- 7) Highlight the fuel reserve time field. This time should be set to the amount of flight time equal to the amount of fuel reserve desired.
- 8) To change the reserve fuel time, enter a time (00:00 to 23:59; hours:minutes). The default setting is 00:45 minutes.
- 9) Press the **ENT** Key.
- 10) Push the **FMS** Knob to return to the Navigation Map Page.

FIELD OF VIEW (SVT)

The map can display the boundaries of the PFD Synthetic Vision Technology (SVT) lateral field of view. The field of view is shown as two dashed lines forming a V shape in front of the aircraft symbol on the map. This is only available if SVT is installed on the aircraft.

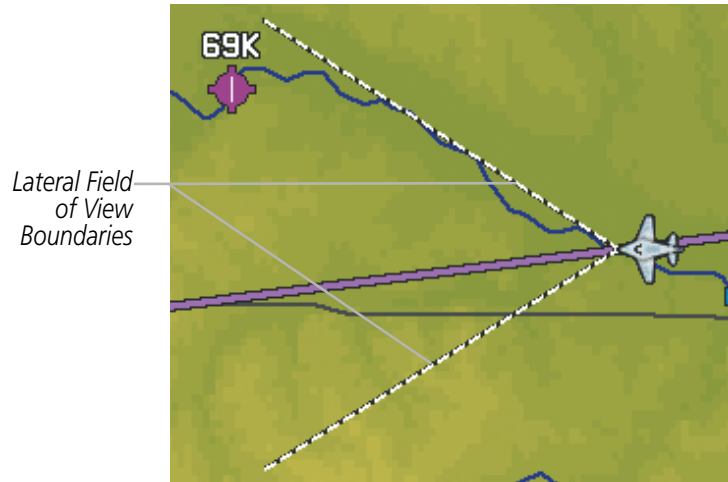

Figure 5-31 Navigation Map - Field of View

Displaying/removing the field of view:

- 1) Press the **MENU** Key with the Navigation Map Page displayed. The cursor flashes on the 'Map Setup' option.
- 2) Press the **ENT** Key. The Map Setup Menu is displayed.
- 3) Select the 'Map' group.
- 4) Press the **ENT** Key.
- 5) Highlight the 'FIELD OF VIEW' field.
- 6) Select 'On' or 'Off'.
- 7) Push the **FMS** Knob to return to the Navigation Map Page.

SELECTED ALTITUDE INTERCEPT ARC

The map can display the location along the current track where the aircraft will intercept the selected altitude. The location will be shown as a cyan arc when the aircraft is actually climbing or descending.

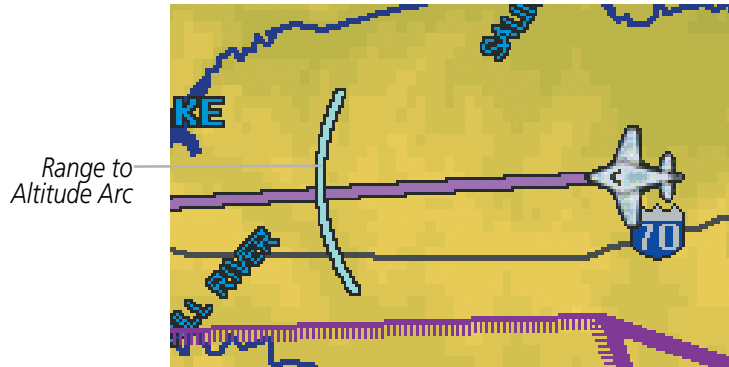

Figure 5-32 Navigation Map - Range to Altitude Arc

Displaying/removing the selected altitude intercept arc:

- 1) Press the **MENU** Key with the Navigation Map Page displayed. The cursor flashes on the 'Map Setup' option.
- 2) Press the **ENT** Key. The Map Setup Menu is displayed.
- 3) Select the 'Map' group.
- 4) Press the **ENT** Key.
- 5) Highlight the 'SEL ALT ARC' field.
- 6) Select 'On' or 'Off'.
- 7) Push the **FMS** Knob to return to the Navigation Map Page.

DESTINATION AIRPORT INFORMATION

The destination airport for which the information is displayed is determined as follows.

- The destination airport is the last airport in the active flight plan if:
 - No arrival or approach is loaded, or
 - An arrival waypoint is part of the active leg and no approach is loaded, or
 - The active leg is past the MAP
- The destination airport is the airport prior to the procedure(s) in the active flight plan if:
 - An arrival and/or approach is loaded and neither are active
- The destination airport is the airport associated with the approach if:
 - An arrival waypoint is part of the active leg and an approach is loaded, or
 - The approach is active
- The destination airport is the Direct-to waypoint if:
 - The Direct-to waypoint is not in the active flight plan and is an airport

If none of these conditions are met, then the destination airport is undefined and the destination information fields are shown as dashes.

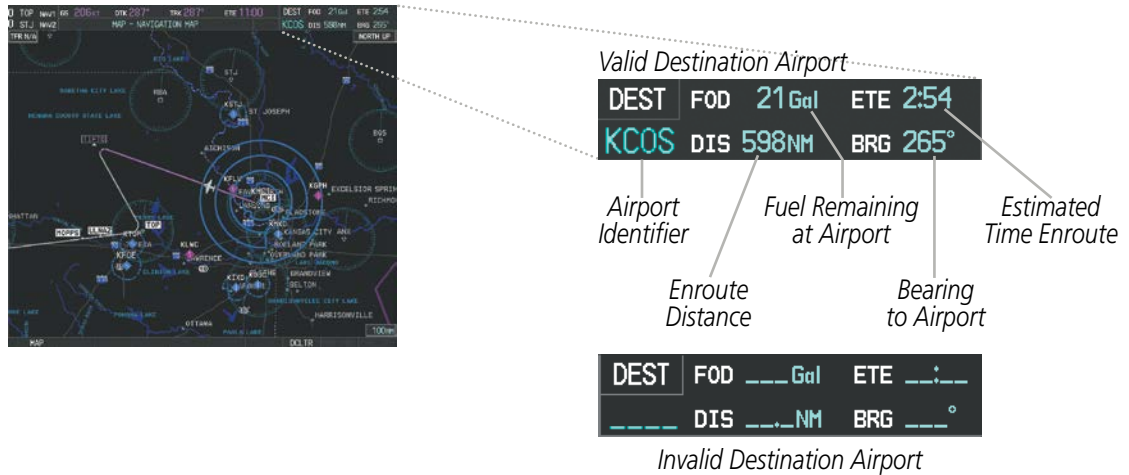

Figure 5-33 Destination Airport Information

5.3 WAYPOINTS

Waypoints are predetermined geographical positions (internal database) or pilot-entered positions, and are used for all phases of flight planning and navigation.

Communication and navigation frequencies can be tuned “automatically” from various Waypoint Information (WPT) pages, Nearest (NRST) pages, and the Nearest Airports Window (on PFD). This auto-tuning feature simplifies frequency entry over manual tuning. Refer to the Audio Panel and CNS section for details on auto-tuning.

Waypoints can be selected by entering the ICAO identifier, entering the name of the facility, or by entering the city name. See the System Overview section for detailed instructions on entering data in Perspective. As a waypoint identifier, facility name, or location is entered, The system’s Spell’N’Find feature scrolls through the database, displaying those waypoints matching the characters which have been entered to that point. A direct-to navigation leg to the selected waypoint can be initiated by pressing the **Direct-to** Key on any of the waypoint pages.



Figure 5-34 Waypoint Information Window

If duplicate entries exist for the entered facility name or location, additional entries may be viewed by continuing to turn the small **FMS** Knob during the selection process. If duplicate entries exist for an identifier, a Duplicate Waypoints Window is displayed when the **ENT** Key is pressed.



Figure 5-35 Waypoint Information Window - Duplicate Identifier

AIRPORTS



NOTE: 'North Up' orientation on the Airport Information Page cannot be changed; the pilot needs to be aware of proper orientation if the Navigation Map orientation is different from the Airport Information Page Map.

The Airport Information Page is the first page in WPT group and allows the pilot to view airport information, load frequencies (COM, NAV, and lighting), review runways, and review instrument procedures that may be involved in the flight plan. See the Audio Panel and CNS Section for more information on loading frequencies (auto-tuning). After engine startup, the Airport Information Page defaults to the airport where the aircraft is located. After a flight plan has been loaded, it defaults to the destination airport. On a flight plan with multiple airports, it defaults to the airport which is the current active waypoint.

In addition to displaying a map of the currently selected airport and surrounding area, the Airport Information Page displays airport information in three boxes labeled 'AIRPORT', 'RUNWAYS', and 'FREQUENCIES'. For airports with multiple runways, information for each runway is available. This information is viewed on the Airport Information Page by pressing the INFO softkey until **INFO-1** is displayed.

- SYSTEM OVERVIEW
- FLIGHT INSTRUMENTS
- EIS
- AUDIO PANEL & CNS
- FLIGHT MANAGEMENT
- HAZARD AVOIDANCE
- AFCS
- ADDITIONAL FEATURES
- APPENDICES
- INDEX

Navigation Map Showing Selected Airport

Airport/Runway Diagram

Softkeys

Airport Information

- ID/Facility/City
- Usage Type/Region
- Lat/Long/Elev
- Fuel Available
- Time Zone (UTC Offset)

Runway Information

- Designation
- Length/Width/Surface
- Lighting Available

COM/NAV Freq. Info.

- Identification
- Frequency
- Availability
- Additional Information

Figure 5-36 Airport Information Page

The following descriptions and abbreviations are used on the Airport Information Page:

- Usage type: Public, Military, Private, or Heliport
- Runway surface type: Hard, Turf, Sealed, Gravel, Dirt, Soft, Unknown, or Water
- Runway lighting type: No Lights, Part Time, Full Time, Unknown, or PCL Freq (for pilot-controlled lighting)
- COM Availability: TX (transmit only), RX (receive only), PT (part time), i (additional information available)

The directory information is viewed on the Airport Directory Page by pressing the INFO softkey until **INFO-2** is displayed. The following are types of airport directory information shown (if available) on the Airport Directory Page:

- **Airport:** Identifier, Site Number, Name, City, State
- **Phones:** Phone/Fax Numbers
- **Hours:** Facility Hours, Light Hours, Tower Hours, Beacon Hours
- **Location:** Sectional, Magnetic Variation
- **Frequencies:** Type/Frequency
- **Transportation:** Ground Transportation Type Available
- **Approach:** Approach Facility Name, Frequency, Frequency Parameter
- **Traffic Pattern Altitudes (TPA):** Aircraft Class/Altitude
- **Weather:** Service Type, Frequency, Phone Number
- **Flight Service Station (FSS):** FSS Name, Phone Numbers
- **Instrument Approaches:** Published Approach, Frequency
- **NAVAIDS:** Type, Identifier, Frequency, Radial, Distance
- **Noise:** Noise Abatement Procedures
- **Charts:** Low Altitude Chart Number
- **Runway:** Headings, Length, Width, Obstructions, Surface
- **Obstructions:** General Airport Obstructions
- **Special Operations at Airport**
- **Services Available:** Category, Specific Service
- **Notes:** Airport Notes
- **Pilot Controlled Lighting:** High/Med/Low Clicks/Second
- **FBO:** Type, Frequencies, Services, Fees, Fuel, Credit Cards, Phone/Fax Numbers

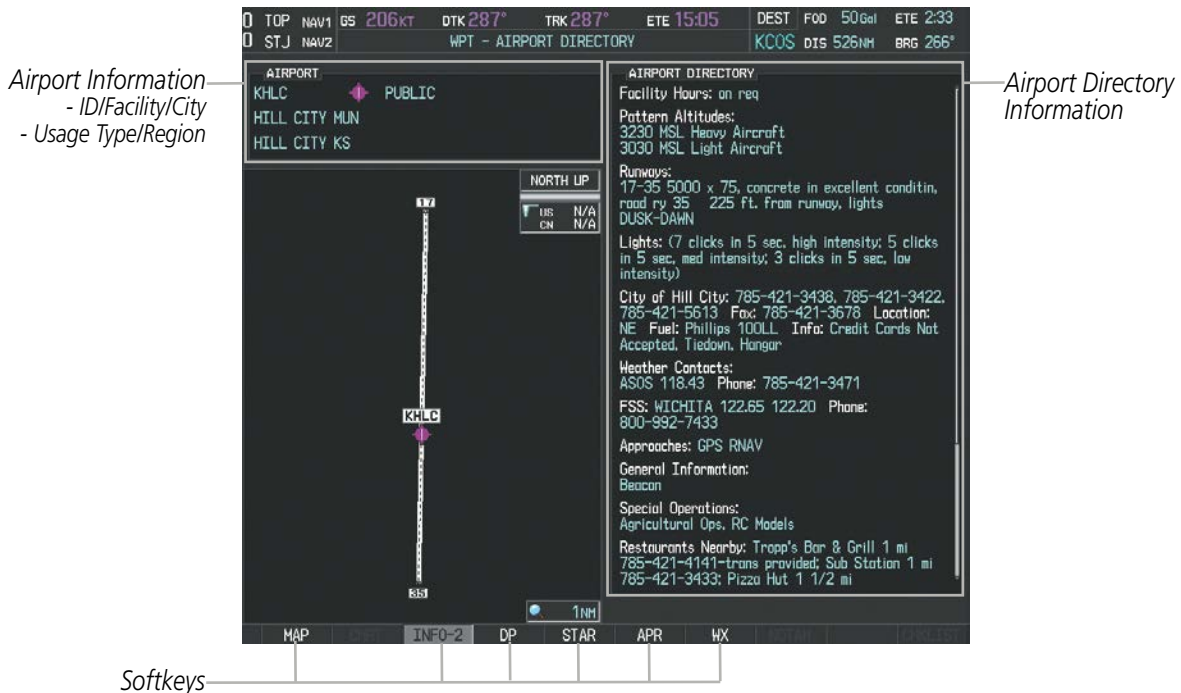

Figure 5-37 Airport Directory Page Example

Selecting an airport for review by identifier, facility name, or location:

- 1) From the Airport Information Page, push the **FMS** Knob.
- 2) Use the **FMS** Knobs and enter an identifier, facility name, or location.
- 3) Press the **ENT** Key.
- 4) Push the **FMS** Knob to remove the cursor.

Selecting a runway:

- 1) With the Airport Information Page displayed, push the **FMS** Knob to activate the cursor.
- 2) Turn the large **FMS** Knob to place the cursor in the 'RUNWAYS' Box, on the runway designator.
- 3) Turn the small **FMS** Knob to display the desired runway (if more than one) for the selected airport.
- 4) To remove the flashing cursor, push the **FMS** Knob.

Viewing a destination airport:

From the Airport Information Page press the **MENU** Key. Select 'View Destination Airport'. The Destination Airport is displayed.

The Airport Frequencies Box uses the descriptions and abbreviations listed in the following table:

Communication Frequencies			Navigation Frequencies
Approach *	Control	Pre-Taxi	ILS
Arrival *	CTA *	Radar	LOC
ASOS	Departure *	Ramp	
ATIS	Gate	Terminal *	
AWOS	Ground	TMA *	
Center	Helicopter	Tower	
Class B *	Multicom	TRSA *	
Class C *	Other	Unicom	
Clearance			
* May include Additional Information			

Table 5-5 Airport Frequency Abbreviations

A departure, arrival, or approach can be loaded using the softkeys on the Airport Information Page. See the Procedures section for details. METARs or TAFs applicable to the selected airport can be selected for display (see the Hazard Avoidance section for details about weather).

Perspective provides a **NRST** Softkey on the PFD, which gives the pilot quick access to nearest airport information (very useful if an immediate landing is required). The Nearest Airports Window displays a list of up to 25 nearest airports (three entries can be displayed at one time). If there are more than three they are displayed in a scrollable list. If there are no nearest airports available, "NONE WITHIN 200NM" is displayed.

- SYSTEM OVERVIEW
- FLIGHT INSTRUMENTS
- EIS
- AUDIO PANEL & CNS
- FLIGHT MANAGEMENT
- HAZARD AVOIDANCE
- AFCS
- ADDITIONAL FEATURES
- APPENDICES
- INDEX



Figure 5-38 Nearest Airports Window on PFD

Pressing the **ENT** Key displays the PFD Airport Information Window for the highlighted airport. Pressing the **ENT** Key again returns to the Nearest Airports Window with the cursor on the next airport in the list. Continued presses of the **ENT** Key sequences through the information pages for all airports in the Nearest Airports list.

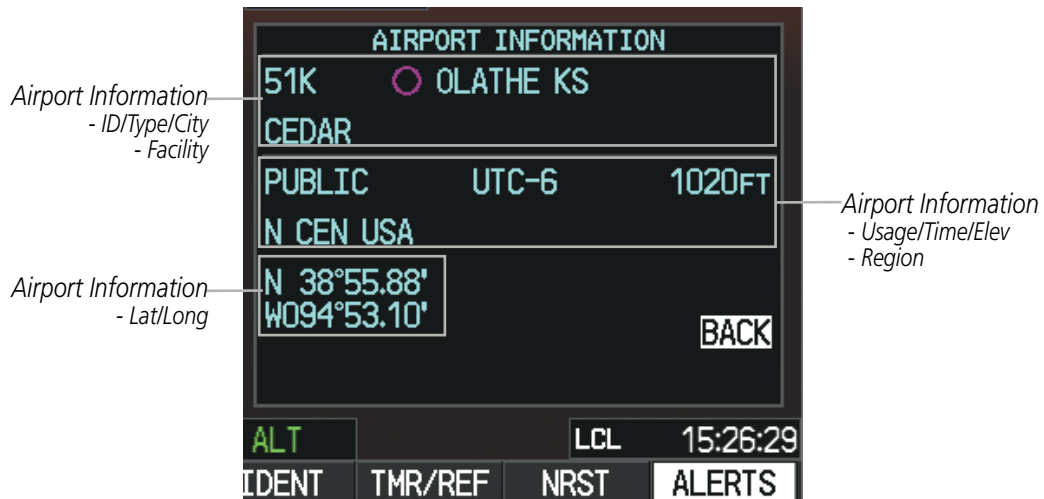

Figure 5-39 Airport Information Window on PFD

The Nearest Airports Page on the MFD is first in the group of NRST pages because of its potential use in the event of an in-flight emergency. In addition to displaying a map of the currently selected airport and surrounding area, the page displays nearest airport information in five boxes labeled 'NEAREST AIRPORTS', 'INFORMATION', 'RUNWAYS', 'FREQUENCIES', and 'APPROACHES'.

The selected airport is indicated by a white arrow, and a dashed white line is drawn on the navigation map from the aircraft position to the nearest airport. Up to five nearest airports, one runway, up to three frequencies, and up to three approaches are visible at one time. If there are more than can be shown, each list can be scrolled. If there are no items for display in a boxed area, text indicating that fact is displayed. The currently selected airport remains in the list until it is unselected.

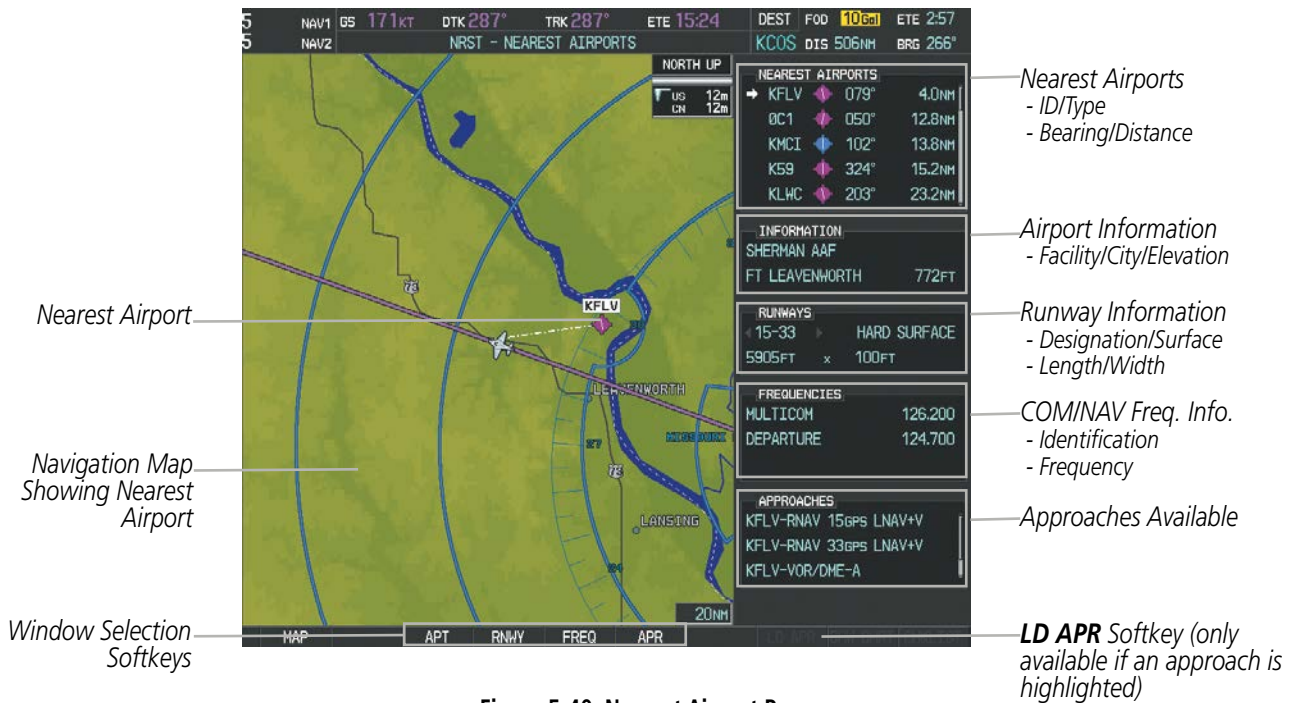

Figure 5-40 Nearest Airport Page

Viewing information for a nearest airport on the PFD:

- 1) Press the **NRST** Softkey to display the Nearest Airports Window. Push the **FMS** Knob to activate the cursor.
- 2) Highlight the airport identifier with the **FMS** Knob and press the **ENT** Key to display the Airport Information Window.
- 3) To return to the Nearest Airports Window press the **ENT** Key (with the cursor on 'BACK') or press the **CLR** Key. The cursor is now on the next airport in the nearest airports list. (Repeatedly pressing the **ENT** Key moves through the airport list, alternating between the Nearest Airports Window and the Airport Information Window.)
- 4) Press the **CLR** Key or the **NRST** Softkey to close the PFD Nearest Airports Window.

Viewing information for a nearest airport on the MFD:

- 1) Turn the large **FMS** Knob to select the NRST page group.
- 2) Turn the small **FMS** Knob to select the Nearest Airports Page (it is the first page of the group, so it may already be selected). If there are no Nearest Airports available, "NONE WITHIN 200 NM" is displayed.
- 3) Press the **APT** Softkey; or push the **FMS** Knob; or press the **MENU** Key, highlight 'Select Airport Window' and press the **ENT** Key. The cursor is placed in the 'NEAREST AIRPORTS' Box. The first airport in the nearest airports list is highlighted.

- 4) Turn the **FMS** Knob to highlight the desired airport. (Pressing the **ENT** Key also moves to the next airport.)
- 5) Push the **FMS** Knob to remove the flashing cursor.

Viewing runway information for a specific airport:

- 1) With the Nearest Airports Page displayed, press the **RNWX** Softkey; or press the **MENU** Key, highlight ‘Select Runway Window’; and press the **ENT** Key. The cursor is placed in the ‘RUNWAYS’ Box.
- 2) Turn the small **FMS** Knob to select the desired runway.
- 3) Push the **FMS** Knob to remove the flashing cursor.

See the Audio Panel and CNS Section for frequency selection and the Procedures section for approaches.

The Nearest Airports Box on the System Setup Page defines the minimum runway length and surface type used when determining the 25 nearest airports to display on the MFD Nearest Airports Page. A minimum runway length and/or surface type can be entered to prevent airports with small runways or runways that are not appropriately surfaced from being displayed. Default settings are 0 feet (or meters) for runway length and “HARD/SOFT” for runway surface type.

Selecting nearest airport surface matching criteria:

- 1) Use the **FMS** Knob to select the System Setup Page.
- 2) Push the **FMS** Knob momentarily to activate the flashing cursor.
- 3) Turn the large **FMS** Knob to highlight the runway surface field in the Nearest Airports Box.
- 4) Turn the small **FMS** Knob to select the desired runway option (ANY, HARD ONLY, HARD/SOFT).
- 5) Press the **ENT** Key.
- 6) Push the **FMS** Knob to remove the flashing cursor.

Selecting nearest airport minimum runway length matching criteria:

- 1) Use the **FMS** Knob to select the System Setup Page.
- 2) Push the **FMS** Knob momentarily to activate the flashing cursor.
- 3) Turn the large **FMS** Knob to highlight the minimum length field in the Nearest Airport Box.
- 4) Use the **FMS** Knob to enter the minimum runway length (zero to 25,000 feet) and press the **ENT** Key.
- 5) Push the **FMS** Knob to remove the flashing cursor.



Nearest Airport Criteria
 - Type of Runway Surface
 - Minimum Runway Length

Figure 5-41 System Setup Page - Nearest Airport Selection Criteria

INTERSECTIONS

NOTE: The VOR displayed on the Intersection Information Page is the nearest VOR, not necessarily the VOR used to define the intersection.

The Intersection Information Page is used to view information about intersections. In addition to displaying a map of the currently selected intersection and surrounding area, the Intersection Information Page displays intersection information in three boxes labeled ‘INTERSECTION’, ‘INFORMATION’, and ‘NEAREST VOR’.



Figure 5-42 Intersection Information Page

Selecting an intersection:

- 1) With the Intersection Information Page displayed, enter an identifier in the Intersection Box.
 - 2) Press the **ENT** Key.
 - 3) Push the **FMS** Knob to remove the flashing cursor.
- Or:
- 1) With the Nearest Intersections Page displayed, push the **FMS** Knob.
 - 2) Press the **ENT** Key or turn either **FMS** Knob to select an identifier in the Nearest Intersection Box.
 - 3) Push the **FMS** Knob to remove the flashing cursor.

The Nearest Intersections Page can be used to quickly find an intersection close to the flight path. In addition to displaying a map of the surrounding area, the page displays information for up to 25 nearest intersections in three boxes labeled 'NEAREST INT', 'INFORMATION', and 'REFERENCE VOR'.

The selected intersection is indicated by a white arrow. Up to eleven intersections are visible at a time. If there are more than can be shown, the list can be scrolled. If there are no items for display, text indicating that fact is displayed.



NOTE: The list only includes waypoints that are within 200 nm.



Figure 5-43 Nearest Intersections Page

NDBs

The NDB Information Page is used to view information about NDBs. In addition to displaying a map of the currently selected NDB and surrounding area, the page displays NDB information in four boxes labeled 'NDB', 'INFORMATION', 'FREQUENCY', and 'NEAREST AIRPORT'.



Figure 5-44 NDB Information Page



NOTE: Compass locator (LOM, LMM): a low power, low or medium frequency radio beacon installed in conjunction with the instrument landing system. When LOM is used, the locator is at the Outer Marker; when LMM is used, the locator is at the Middle Marker.

Selecting an NDB:

- 1) With the NDB Information Page displayed, enter an identifier, the name of the NDB, or the city in which it's located in the NDB Box.
 - 2) Press the **ENT** Key.
 - 3) Push the **FMS** Knob to remove the flashing cursor.
- Or:**
- 1) With the Nearest NDB Page displayed, push the **FMS** Knob.
 - 2) Press the **ENT** Key or turn either **FMS** Knob to select an identifier in the Nearest NDB Box.
 - 3) Push the **FMS** Knob to remove the flashing cursor.

The Nearest NDB Page can be used to quickly find a NDB close to the flight path. In addition to displaying a map of the surrounding area, the page displays information for up to 25 nearest NDBs in three boxes labeled 'NEAREST NDB', 'INFORMATION', and 'FREQUENCY'.

A white arrow before the NDB identifier indicates the selected NDB. Up to eleven NDBs are visible at a time. If there are more than can be shown, each list can be scrolled. The list only includes waypoints that are within 200nm. If there are no NDBs in the list, text indicating that there are no nearest NDBs is displayed. If there are no nearest NDBs in the list, the information and frequency fields are dashed.



Figure 5-45 Nearest NDB Page

VORs

The VOR Information Page can be used to view information about VOR and ILS signals (since ILS signals can be received on a NAV receiver), or to quickly auto-tune a VOR or ILS frequency. Localizer information cannot be viewed on the VOR Information Page. If a VOR station is combined with a TACAN station it is listed as a VORTAC on the VOR Information Page and if it includes only DME, it is displayed as VOR-DME.

In addition to displaying a map of the currently selected VOR and surrounding area, the VOR Information Page displays VOR information in four boxes labeled 'VOR', 'INFORMATION', 'FREQUENCY', and 'NEAREST AIRPORT'.



Figure 5-46 VOR Information Page

The VOR classes used in the VOR information box are: LOW ALTITUDE, HIGH ALTITUDE, and TERMINAL.

Selecting a VOR:

- 1) With the VOR Information Page displayed, enter an identifier, the name of the VOR, or the city in which it's located in the VOR Box.
- 2) Press the **ENT** Key.
- 3) Push the **FMS** Knob to remove the flashing cursor.

Or:

- 1) With the Nearest VOR Page displayed, push the **FMS** Knob or press the **VOR** Softkey.
- 2) Press the **ENT** Key or turn either **FMS** Knob to select an identifier in the Nearest VOR Box.
- 3) Push the **FMS** Knob to remove the flashing cursor.

Or:

- 1) With the Nearest VOR Page displayed, press the **MENU** Key.
- 2) Highlight 'Select VOR Window', and press the **ENT** Key.
- 3) Press the **ENT** Key or turn either **FMS** Knob to select an identifier in the Nearest VOR Box.
- 4) Push the **FMS** Knob to remove the flashing cursor.
- 5) Push the **FMS** Knob to remove the flashing cursor.

The Nearest VOR Page can be used to quickly find a VOR station close to the aircraft. Also, a NAV frequency from a selected VOR station can be loaded from the Nearest VOR Page. In addition to displaying a map of the surrounding area, the Nearest VOR Page displays information for up to 25 nearest VOR stations in three boxes labeled 'NEAREST VOR', 'INFORMATION', and 'FREQUENCY'. The list only includes waypoints that are within 200 nm.

A white arrow before the VOR identifier indicates the selected VOR. Up to eleven VORs are visible at a time. If there are more than can be shown, each list can be scrolled. If there are no VORs in the list, text indicating that there are no nearest VORs is displayed. If there are no nearest VORs in the list, the information is dashed.



Figure 5-47 Nearest VOR Page

VRPs

The VRP Information Page is used to view information about visual reporting points (VRPs). In addition to displaying a map of the currently selected VRP and surrounding area, the VRP Information Page displays VRP information in two boxes labeled 'VRP' and 'INFORMATION'.

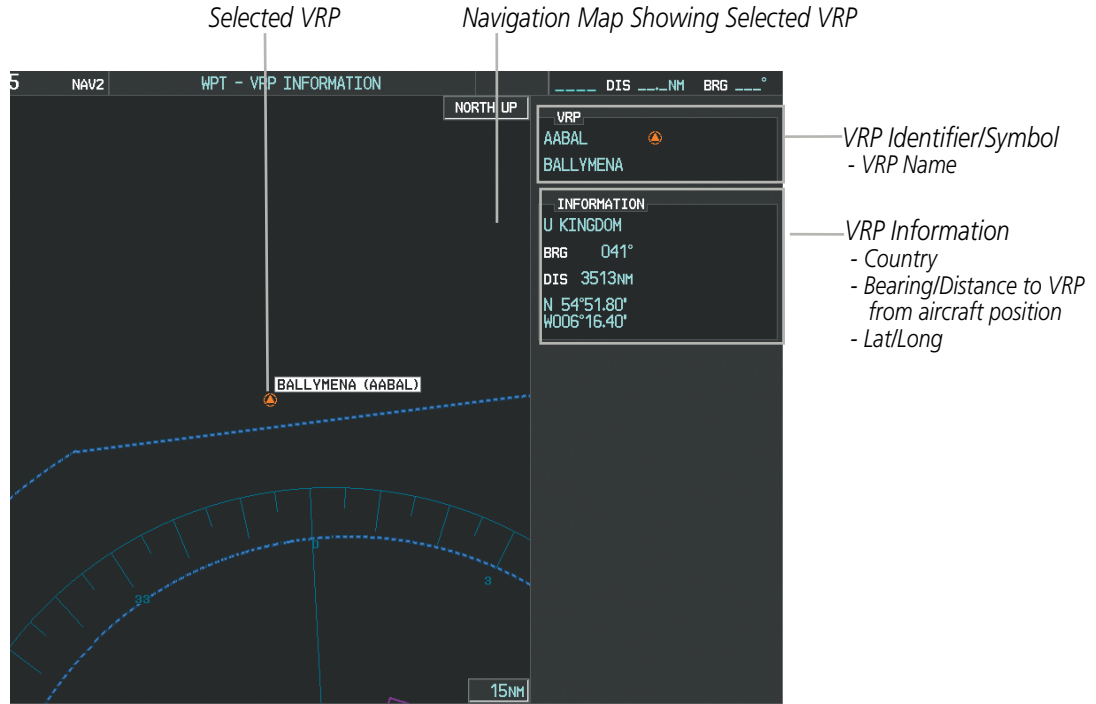

Figure 5-48 VRP Information Page

Selecting a VRP:

- 1) With the WPT - VRP INFORMATION Page displayed, enter the identifier or the name of the VRP in the 'VRP' Box.
- 2) Press the **ENT** Key.
- 3) Push the **FMS** Knob to remove the flashing cursor.

Or:

- 1) With the NRST - NEAREST VRP Page displayed, push the **FMS** Knob.
- 2) Press the **ENT** Key or turn either **FMS** Knob to select an identifier in the 'NEAREST VRP' Box.
- 3) Push the **FMS** Knob to remove the flashing cursor.

The to quickly find a VRP close to the aircraft. In addition to displaying a map of the surrounding area, the Nearest VRP Page displays information for up to 25 nearest VRPs in two boxes labeled 'NEAREST VRP' and 'INFORMATION'. The list only includes VRPs that are within 200 nm.

A white arrow before the VRP identifier indicates the selected VRP. Up to eleven VRPs are visible at a time. If there are more than can be shown, the list can be scrolled. If there are no VRPs in the list, text indicating that there are no nearest VRPs is displayed. If there are no nearest VRPs in the list, the information is dashed.

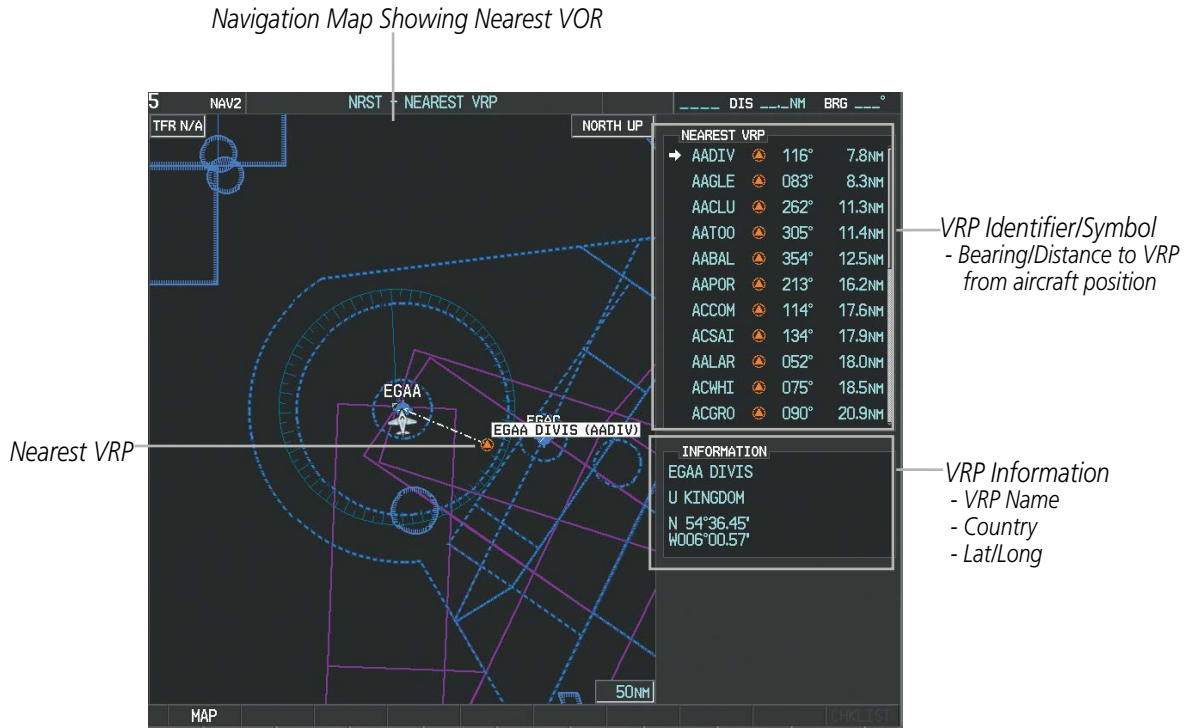

Figure 5-49 Nearest VRP Page

USER WAYPOINTS

The system can create and store up to 1,000 user-defined waypoints. User waypoints can be created from any map page (except PFD Inset Map, AUX-Trip Planning Page, or Procedure Pages) by selecting a position on the map using the **Joystick**, or from the User Waypoint Information Page by referencing a bearing/distance from an existing waypoint, bearings from two existing waypoints, or entering a latitude/longitude. Once a waypoint has been created, it can be renamed, deleted, or moved. Temporary user waypoints are erased upon system power down.



Figure 5-50 User Waypoint Information Page

Selecting a User Waypoint:

- 1) With the User Waypoint Information Page displayed, enter the name of the User Waypoint, or scroll to the desired waypoint in the User Waypoint List using the large **FMS** Knob.
 - 2) Press the **ENT** Key.
 - 3) Push the **FMS** Knob to remove the flashing cursor.
- Or:**
- 1) With the Nearest User Waypoints Page displayed, push the **FMS** Knob.
 - 2) Press the **ENT** Key or turn either **FMS** Knob to select an identifier in the Nearest USR Box.
 - 3) Push the **FMS** Knob to remove the flashing cursor.



Figure 5-51 Nearest User Waypoint Page

CREATING USER WAYPOINTS

User waypoints can be created from the User Waypoint Information Page in the following ways:

Creating user waypoints from the User Waypoint Information Page:

- 1) Press the **NEW** Softkey, **or** press the **MENU** Key and select 'Create New User Waypoint'.
- 2) Enter a user waypoint name (up to six characters).
- 3) Press the **ENT** Key. The current aircraft position is the default location of the new waypoint.
- 4) If desired, define the type and location of the waypoint in one of the following ways:
 - Select "RAD/RAD" using the small **FMS** Knob, press the **ENT** Key, and enter the two reference waypoint identifiers and radials into the REFERENCE WAYPOINTS window using the **FMS** Knobs.
 - Or:**
 - Select "RAD/DIS" using the small **FMS** Knob, press the **ENT** Key, and enter the reference waypoint identifier, the radial, and the distance into the REFERENCE WAYPOINTS window using the **FMS** Knobs.
 - Or:**
 - Select "LAT/LON" using the small **FMS** Knob, press the **ENT** Key, and enter the latitude and longitude into the INFORMATION window using the **FMS** Knobs.
- 5) Press the **ENT** Key to accept the new waypoint.

- 6) If desired, change the storage method of the waypoint to "TEMPORARY" or "NORMAL" by moving the cursor to "TEMPORARY" and selecting the **ENT** Key to check or uncheck the box.
- 7) Push the **FMS** Knob to remove the flashing cursor.
 - Or:**
 - 1) Push the **FMS** Knob to activate the cursor.
 - 2) Enter a user waypoint name (up to six characters).
 - 3) Press the **ENT** Key. The message 'Are you sure you want to create the new User Waypoint AAAAAA?' is displayed.
 - 4) With 'YES' highlighted, press the **ENT** Key.
 - 5) If desired, define the type and location of the waypoint in one of the following ways:
 - Select "RAD/RAD" using the small **FMS** Knob, press the **ENT** Key, and enter the two reference waypoint identifiers and radials into the REFERENCE WAYPOINTS window using the **FMS** Knobs.
 - Or:**
 - Select "RAD/DIS" using the small **FMS** Knob, press the **ENT** Key, and enter the reference waypoint identifier, the radial, and the distance into the REFERENCE WAYPOINTS window using the **FMS** Knobs.
 - Or:**
 - Select "LAT/LON" using the small **FMS** Knob, press the **ENT** Key, and enter the latitude and longitude into the INFORMATION window using the **FMS** Knobs.
 - 6) Press the **ENT** Key to accept the new waypoint.
 - 7) If desired, change the storage method of the waypoint to "TEMPORARY" or "NORMAL" by moving the cursor to "TEMPORARY" and selecting the **ENT** Key to check or uncheck the box.
 - 8) Push the **FMS** Knob to remove the flashing cursor.

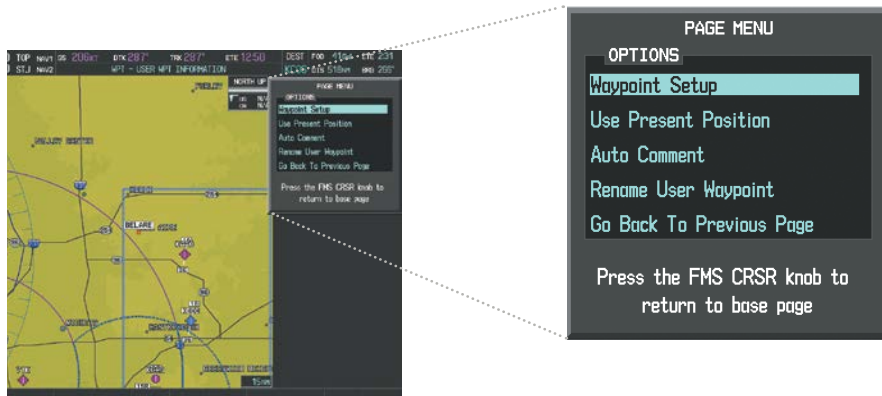

Figure 5-52 User Waypoint Information Page Menu

Creating user waypoints from map pages:

- 1) Press the **Joystick** to activate the panning function and pan to the map location of the desired user waypoint.
- 2) Press the **ENT** Key. The User Waypoint Information Page is displayed with the captured position.



NOTE: If the pointer has highlighted a map database feature, one of three things happens upon pressing the **ENT** Key: 1) information about the selected feature is displayed instead of initiating a new waypoint, 2) a menu pops up allowing a choice between 'Review Airspaces' or 'Create User Waypoint', or 3) a new waypoint is initiated with the default name being the selected map item.

- 3) Enter a user waypoint name (up to six characters).
- 4) Press the **ENT** Key to accept the selected name.
- 5) If desired, define the type and location of the waypoint in one of the following ways:
Select "RAD/RAD" using the small **FMS** Knob, press the **ENT** Key, and enter the two reference waypoint identifiers and radials into the REFERENCE WAYPOINTS window using the **FMS** Knobs.
Or:
Select "RAD/DIS" using the small **FMS** Knob, press the **ENT** Key, and enter the reference waypoint identifier, the radial, and the distance into the REFERENCE WAYPOINTS window using the **FMS** Knobs.
Or:
Select "LAT/LON" using the small **FMS** Knob, press the **ENT** Key, and enter the latitude and longitude into the INFORMATION window using the **FMS** Knobs.
- 6) Press the **ENT** Key to accept the new waypoint.
- 7) If desired, change the storage method of the waypoint to "TEMPORARY" or "NORMAL" by moving the cursor to "TEMPORARY" and selecting the **ENT** Key to check or uncheck the box.
- 8) Push the **FMS** Knob to remove the flashing cursor.
- 9) Press the **GO BACK** Softkey to return to the map page.

EDITING USER WAYPOINTS

Editing a user waypoint comment or location:

- 1) With the User Waypoint Information Page displayed, push the **FMS** Knob to activate the cursor.
- 2) Select a user waypoint in the User Waypoint List, if required, and press the **ENT** Key.
- 3) Move the cursor to the desired field.
- 4) Turn the small **FMS** Knob to make any changes.
- 5) Press the **ENT** Key to accept the changes.
- 6) Push the **FMS** Knob to remove the flashing cursor.

Renaming user waypoints:

- 1) Highlight a user waypoint in the User Waypoint List. Press the **RENAME** Softkey, or press the **MENU** Key and select 'Rename User Waypoint'.
- 2) Enter a new name.
- 3) Press the **ENT** Key. The message 'Do you want to rename the user waypoint AAAAAA toBBBBBB?' is displayed.
- 4) With 'YES' highlighted, press the **ENT** Key.
- 5) Push the **FMS** Knob to remove the flashing cursor.

Changing the location of an existing waypoint to the aircraft present position:

- 1) Enter a waypoint name or select the waypoint in the User Waypoint List, then press the **ENT** Key.
- 2) Press the **MENU** Key.
- 3) Select 'Use Present Position'.
- 4) Press the **ENT** Key twice. The new waypoint's location is saved.
- 5) Push the **FMS** Knob to remove the flashing cursor.

A system generated comment for a user waypoint incorporates the reference waypoint identifier, bearing, and distance. If a system generated comment has been edited, a new comment can be generated.

Resetting the comment field to the system generated comment:

- 1) Enter a waypoint name or select the waypoint in the User Waypoint List, then press the **ENT** Key.
- 2) Press the **MENU** Key.
- 3) Select 'Auto Comment'.
- 4) Press the **ENT** Key. The generated comment is based on the reference point used to define the waypoint.

The default type of user waypoint (normal or temporary) can be changed using the user waypoint information page menu. Temporary user waypoints are automatically deleted upon the next power cycle.

Changing the user waypoint storage duration default setting:

- 1) With the User Waypoint Information Page displayed, press the **MENU** Key.
- 2) Move the cursor to select 'Waypoint Setup', and press the **ENT** Key.
- 3) Select 'NORMAL' or 'TEMPORARY' as desired, and press the **ENT** Key.
- 4) Push the **FMS** Knob to remove the flashing cursor and return to the User Waypoint Information Page.

DELETING USER WAYPOINTS

Deleting a single user waypoint:

- 1) Highlight a User Waypoint in the User Waypoint List, or enter a waypoint in the User Waypoint field.
- 2) Press the **DELETE** Softkey or press the **CLR** Key. 'Yes' is highlighted in the confirmation window.
- 3) Press the **ENT** Key.
- 4) Push the **FMS** Knob to remove the flashing cursor.

Or:

- 1) Highlight a User Waypoint in the User Waypoint List, or enter a waypoint in the User Waypoint field.
- 2) Press the **MENU** Key.
- 3) Select 'Delete User Waypoint'.
- 4) Press the **ENT** Key twice to confirm the selection.
- 5) Push the **FMS** Knob to remove the flashing cursor.



NOTE: The option to 'Delete All User Waypoints' is not available while the aircraft is in flight.

Deleting all user waypoints:

- 1) Highlight a User Waypoint in the User Waypoint List.
- 2) Press the **MENU** Key.
- 3) Select 'Delete All User Waypoints'.
- 4) Press the **ENT** Key twice to confirm the selection.
- 5) Push the **FMS** Knob to remove the flashing cursor.

5.4 AIRSPACES

Perspective can display the following types of airspaces: Class B/TMA, Class C/TCA, Class D, Restricted, MOA (Military), Other Airspace, Air Defense Interdiction Zone (ADIZ), and Temporary Flight Restriction (TFR).



Figure 5-53 Airspaces

The Nearest Airspaces Page, Airspace Alerts Window, and Airspace Alerts on the PFD provide additional information about airspaces and the location of the aircraft in relationship to them.

The Airspace Alerts Box allows the pilot to turn the controlled/special-use airspace message alerts on or off. This does not affect the alerts listed on the Nearest Airspaces Page or the airspace boundaries depicted on the Navigation Map Page. It simply turns on/off the warning provided when the aircraft is approaching or near an airspace.

An altitude buffer is also provided which “expands” the vertical range above or below an airspace. For example, if the buffer is set at 500 feet, and the aircraft is more than 500 feet above/below an airspace, an alert message is not generated, but if the aircraft is less than 500 feet above/below an airspace and projected to enter it, the pilot is notified with an alert message. The default setting for the altitude buffer is 200 feet.

Changing the altitude buffer distance setting:

- 1) Use the **FMS** Knob to select the AUX - System Setup Page.
- 2) Push the **FMS** Knob momentarily to activate the flashing cursor.
- 3) Turn the large **FMS** Knob to highlight the altitude buffer field in the Airspace Alerts Box.
- 4) Use the **FMS** Knob to enter an altitude buffer value and press the **ENT** Key.
- 5) Push the **FMS** Knob to remove the flashing cursor.

Turning an airspace alert on or off:

- 1) Use the **FMS** Knob to select the AUX - System Setup Page.
- 2) Push the **FMS** Knob momentarily to activate the flashing cursor.
- 3) Turn the large **FMS** Knob to highlight the desired field in the Airspace Alerts Box.
- 4) Turn the small **FMS** Knob clockwise to turn the airspace alert ON or counterclockwise to turn the alert OFF.
- 5) Push the **FMS** Knob to remove the flashing cursor.



Figure 5-54 System Setup Page - Airspace Alerts

Map ranges for the airspace boundaries are selected from the Aviation Group in the Map Setup Menu. See the Aviation Symbol Information Table for the default and maximum ranges for each type of airspace and the symbol used to define the airspace area.

The Nearest Airspaces Page can be used to quickly find airspaces close to the flight path. In addition, a selected frequency associated with the airspace can be loaded from the Nearest Airspaces Page. In addition to displaying a map of airspace boundaries and surrounding area, the Nearest Airspaces Page displays airspace information in four boxes labeled 'AIRSPACE ALERTS', 'AIRSPACE, AGENCY', 'VERTICAL LIMITS', and 'FREQUENCIES'.

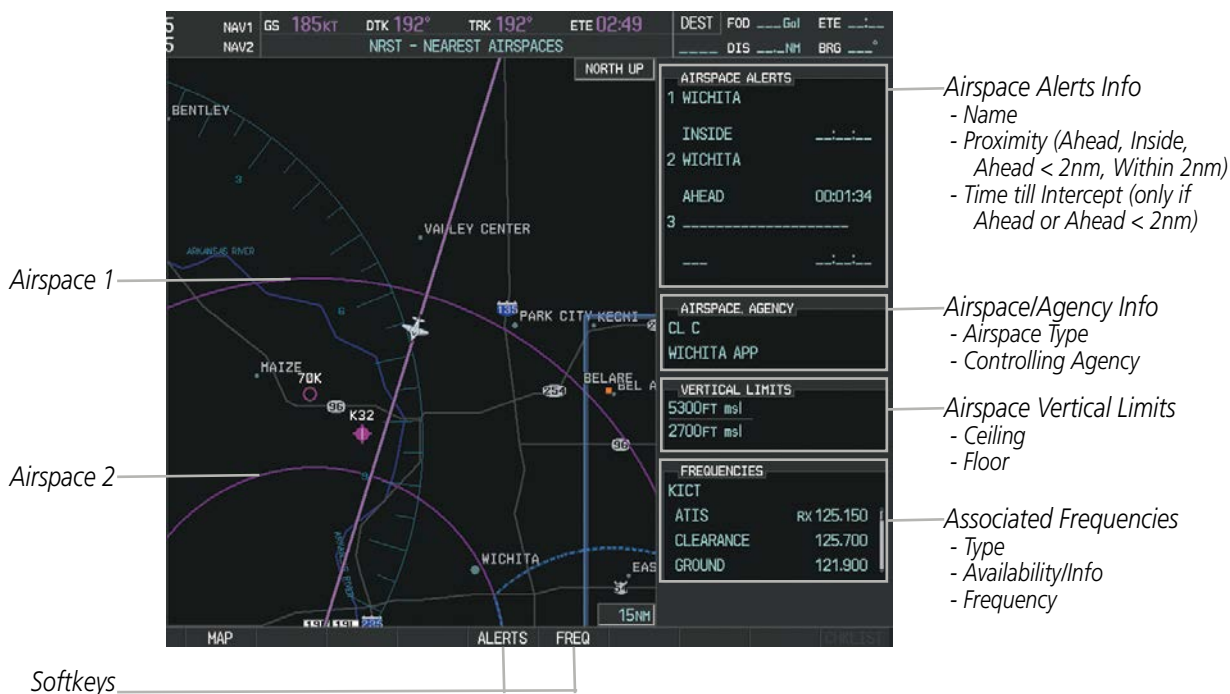

Figure 5-55 Nearest Airspaces Page

Airspace alerts and associated frequencies are shown in scrollable lists on the Nearest Airspaces Page. The **ALERTS** and **FREQ** softkeys place the cursor in the respective list. The **FREQ** Softkey is enabled only if one or more frequencies exist for a selected airspace.

Selecting and viewing an airspace alert with its associated information:

- 1) Select the Nearest Airspaces Page.
- 2) Press the **ALERTS** Softkey; or push the **FMS** Knob; or press the **MENU** Key, highlight 'Select Alerts Window', and press the **ENT** Key. The cursor is placed in the 'AIRSPACE ALERTS' Box.
- 3) Select the desired airspace.
- 4) Push the **FMS** Knob to remove the flashing cursor.

Pressing the PFD **ALERTS** Softkey displays the message window on the PFD. The following airspace alerts are displayed in the message window:

Message	Comments
INSIDE ARSPC – Inside airspace.	The aircraft is inside the airspace.
ARSPC AHEAD – Airspace ahead – less than 10 minutes.	Special use airspace is ahead of aircraft. The aircraft penetrates the airspace within 10 minutes.
ARSPC NEAR – Airspace near and ahead.	Special use airspace is near and ahead of the aircraft position.
ARSPC NEAR – Airspace near – less than 2 nm.	Special use airspace is within 2 nm of the aircraft position.

Table 5-6 PFD Airspace Alert Messages

The Smart Airspace function de-emphasizes airspaces above or below the current aircraft altitude. The function does not require the aircraft present position or flight path to enter the lateral boundaries of the airspace. If the current aircraft altitude is within 1100 feet of the vertical boundaries of the airspace, the airspace boundary is shown normally. If the current aircraft altitude is not within 1100 feet of the vertical boundaries of the airspace, the airspace boundary is shown subdued.

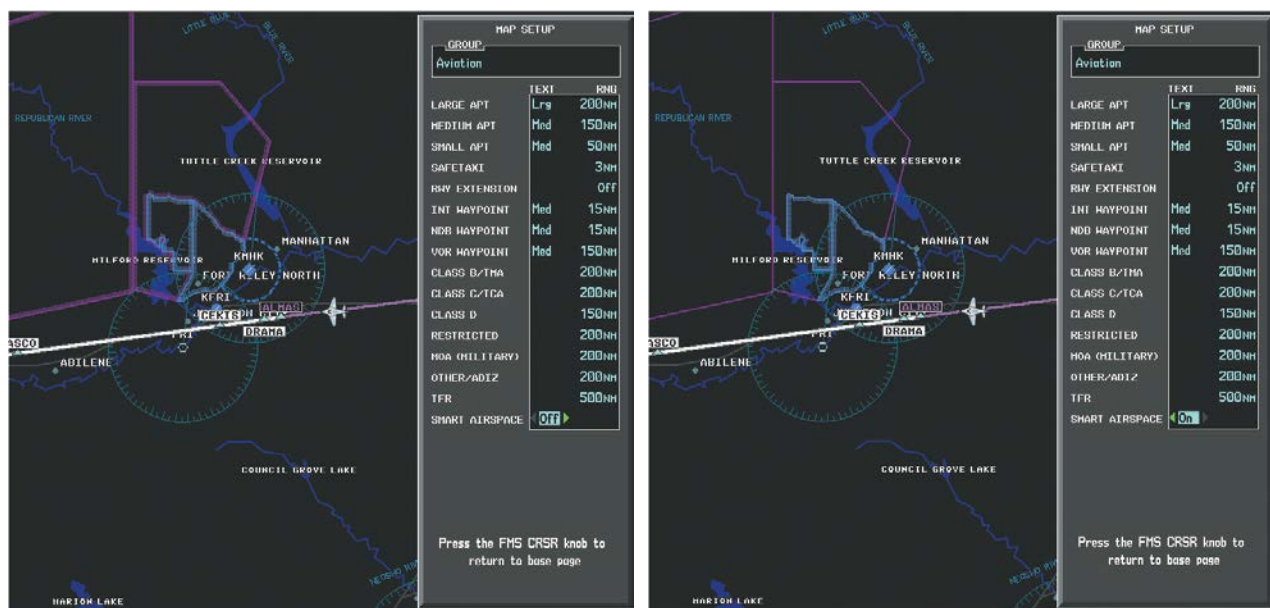

Smart Airspace Off

Smart Airspace On

Figure 5-56 Smart Airspace

Turning smart airspace on or off:

- 1) Use the **FMS** Knob to select the Navigation Map Page.
- 2) Press the **MENU** Key, and press the **ENT** Key. The cursor is placed in the 'GROUP' Box.
- 3) Turn the small **FMS** Knob to highlight the 'Aviation' in the 'GROUP' Box and press the **ENT** Key.
- 4) Turn the large **FMS** Knob to highlight the 'SMART AIRSPACE' field in the Aviation Map Setup Window.
- 5) Turn the small **FMS** Knob clockwise to turn smart airspace ON or counterclockwise to turn smart airspace OFF.
- 6) Push the **FMS** Knob to remove the flashing cursor.

5.5 DIRECT-TO NAVIGATION

The Direct-to method of navigation, initiated by pressing the **→** Key on either the MFD or PFD, is quicker to use than a flight plan when the desire is to navigate to a single point such as a nearby airport.

Once a direct-to is activated, the system establishes a point-to-point course line from the present position to the selected direct-to destination. Course guidance is provided until the direct-to is replaced with a new direct-to or flight plan, or cancelled.

A vertical navigation (VNV) direct-to creates a descent path (and provides guidance to stay on the path) from the current altitude to a selected altitude at the direct-to waypoint. Vertical navigation is based on barometric altitudes, not on GPS altitude, and is used for cruise and descent phases of flight.

The Direct-to Window allows selection and activation of direct-to navigation. The Direct-to Window displays selected direct-to waypoint data on the PFD and the MFD.

SYSTEM OVERVIEW

FLIGHT INSTRUMENTS

EIS

AUDIO PANEL & CNS

FLIGHT MANAGEMENT

HAZARD AVOIDANCE

AFCS

ADDITIONAL FEATURES

APPENDICES

INDEX



Figure 5-57 Direct-to Window - MFD



Figure 5-58 Direct-to Window - PFD

Any waypoint can be entered as a direct-to destination from the Direct-to Window.

Entering a waypoint identifier, facility name, or city as a direct-to destination:

- 1) Press the **➔** Key. The Direct-to Window is displayed (with the active flight plan waypoint as the default selection or a blank waypoint field if no flight plan is active).
- 2) Turn the small **FMS** Knob clockwise to begin entering a waypoint identifier (turning it counter-clockwise brings up the waypoint selection submenu - press the **CLR** Key to remove it), or turn the large **FMS** Knob to select the facility name, or city field and turn the small **FMS** Knob to begin entering a facility name or city. If duplicate entries exist for the entered facility or city name, additional entries can be viewed by turning the small **FMS** Knob during the selection process.
- 3) Press the **ENT** Key. The 'Activate?' field is highlighted.
- 4) Press the **ENT** Key to activate the direct-to.

Any waypoint contained in the active flight plan can be selected as a direct-to waypoint from the Direct-to Window, the Active Flight Plan Page, or the Active Flight Plan Window.

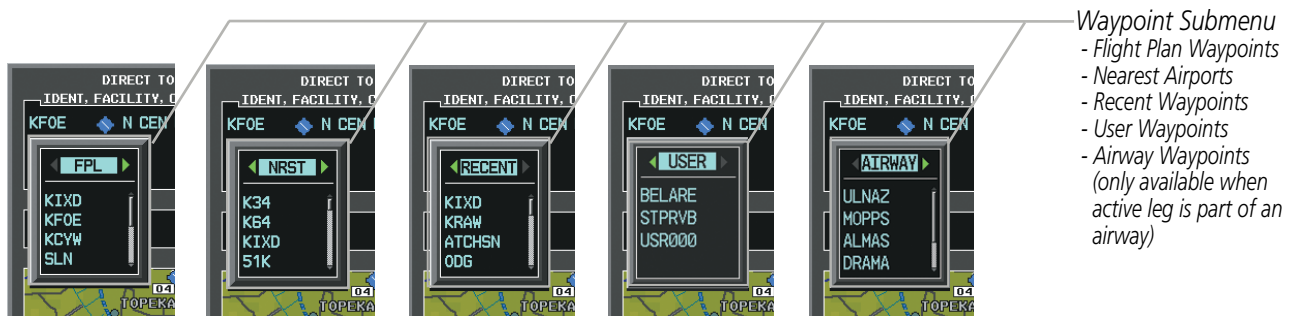

Figure 5-59 Waypoint Submenu

Selecting an active flight plan waypoint as a direct-to destination:

- 1) While navigating an active flight plan, press the **➔** Key. The Direct-to Window is displayed with the active flight plan waypoint as the default selection.
- 2) Turn the small **FMS** Knob counter-clockwise to display a list of flight plan waypoints (the FPL list is populated only when navigating a flight plan).
- 3) Select the desired waypoint.
- 4) Press the **ENT** Key. The cursor is now displayed on 'ACTIVATE?'.
- 5) Press the **ENT** Key again to activate the direct-to.

Or:

- 1) Select the Active Flight Plan Page on the MFD, or the Active Flight Plan Window on the PFD.
- 2) Select the desired waypoint.
- 3) Press the **➔** Key.
- 4) Press the **ENT** Key. The cursor is now displayed on 'ACTIVATE?'.
- 5) Press the **ENT** Key again to activate the direct-to.

Any NRST, RECENT, USER, or AIRWAY waypoints can be selected as a direct-to destination in the Direct-to Window.

Selecting a NRST, RECENT, USER, or AIRWAY waypoint as a direct-to destination:

- 1) Press the **➔** Key. The Direct-to Window is displayed (with the active flight plan destination as the default selection or a blank destination if no flight plan is active).
- 2) Turn the small **FMS** Knob counter-clockwise to display a list of FPL waypoints (the FPL list is populated only when navigating a flight plan, and the AIRWAY list is available only when the active leg is part of an airway).
- 3) Turn the small **FMS** Knob clockwise to display the NRST, RECENT, USER, or AIRWAY waypoints.
- 4) Turn the large **FMS** Knob clockwise to select the desired waypoint.
- 5) Press the **ENT** Key. The cursor is now displayed on 'ACTIVATE?'.
- 6) Press the **ENT** Key again to activate the direct-to.

The Direct-to Window can be displayed from any page and allows selection and activation of direct-to navigation. If the direct-to is initiated from any page except the WPT pages, the default waypoint is the active flight plan waypoint (if a flight plan is active) or a blank waypoint field. Direct-to requests on any WPT page defaults to the displayed waypoint.

Selecting any waypoint as a direct-to destination:

- 1) Select the page or window containing the desired waypoint type and select the desired waypoint.
- 2) Press the **➔** Key to display the Direct-to Window with the selected waypoint as the direct-to destination.
- 3) Press the **ENT** Key. The cursor is now displayed on 'ACTIVATE?'.
- 4) Press **ENT** again to activate the direct-to.

Selecting a nearby airport as a direct-to destination:

- 1) Press the **NRST** Softkey on the PFD; or turn the **FMS** Knob to display the Nearest Airports Page and push the **FMS** Knob.
- 2) Select the desired airport (the nearest one is already selected).
- 3) Press the **➔** Key.
- 4) Press the **ENT** Key. The cursor is now displayed on 'ACTIVATE?'.
- 5) Press the **ENT** Key again to activate the direct-to.

Direct-to destinations may also be selected by using the pointer on the navigation map pages. If no airport, NAVAID, or user waypoint exists at the desired location, a temporary waypoint named 'MAPWPT' is automatically created at the location of the map arrow.

Selecting a waypoint as a direct-to destination using the pointer:

- 1) From a navigation map page, press the **Joystick** to display the pointer.
- 2) Move the **Joystick** to place the pointer at the desired destination location.
- 3) If the pointer is placed on an existing airport, NAVAID, or user waypoint, the waypoint name is highlighted.
- 4) Press the **➔** Key to display the Direct-to Window with the selected point entered as the direct-to destination.

- 5) Press the **ENT** Key. The cursor is now displayed on 'ACTIVATE?'.
- 6) Press the **ENT** Key again to activate the direct-to.

Cancelling a Direct-to:

- 1) Press the **→** Key to display the Direct-to Window.
- 2) Press the **MENU** Key.
- 3) With 'Cancel Direct-To NAV' highlighted, press the **ENT** Key. If a flight plan is still active, the system resumes navigating the flight plan along the closest leg.



Page Menu
- Cancel Direct-To
Navigation

Figure 5-60 Direct-to Window - Cancelling Direct-to Navigation

When navigating a direct-to, the system sets a direct great circle course to the selected destination. The course to a destination can also be manually selected using the course field ('COURSE') on the Direct-to Window.

Selecting a manual direct-to course:

- 1) Press the **→** Key. The Direct-to Window is displayed with the destination field highlighted.
- 2) Highlight the course field.
- 3) Enter the desired course.
- 4) Press the **ENT** Key. The cursor is now displayed on 'ACTIVATE?'.
- 5) Press the **ENT** Key again to activate the direct-to.

Reselecting the direct course from the current position:

- 1) Press the **→** Key. The Direct-to Window is displayed with the destination field highlighted.
- 2) Press the **ENT** Key. The cursor is now displayed on 'ACTIVATE?'.
- 3) Press the **ENT** Key again to activate the direct-to.

A direct-to with altitude constraints creates a descent path (and provides guidance to stay on the path) from the aircraft's current altitude to the altitude of the direct-to waypoint. The altitude is reached at the waypoint, or at the specified distance along the flight path if an offset distance has been entered. All VNV altitudes prior to the direct-to destination are removed from the active flight plan upon successful activation of a direct-to destination that is part of the active flight plan. All VNV altitudes following the direct-to waypoint are retained. See the section on Vertical Navigation for more information regarding the use and purpose of VNV altitudes and offset distances.

Entering a VNV altitude and along-track offset for the waypoint:

- 1) Press the **→** Key to display the Direct-to Window.
- 2) Turn the large **FMS** Knob to place the cursor over the 'VNV' altitude field.
- 3) Enter the desired altitude.
- 4) Press the **ENT** Key. The option to select MSL or AGL is now displayed.
- 5) Turn the small **FMS** Knob to select 'MSL' or 'AGL'.
- 6) Press the **ENT** Key. The cursor is now flashing in the VNV offset distance field.
- 7) Enter the desired along-track distance before the waypoint.
- 8) Press the **ENT** Key. The 'Activate?' field is highlighted.
- 9) Press the **ENT** Key to activate.

Removing a VNV altitude constraint:

- 1) Press the **→** Key to display the Direct-to Window.
- 2) Press the **MENU** Key.
- 3) With 'Clear Vertical Constraints' highlighted, press the **ENT** Key.



Page Menu
- Clear Vertical Navigation Constraints

Figure 5-61 Direct-to Window - Clearing Vertical Constraints

5.6 FLIGHT PLANNING

Flight planning consists of building a flight plan by entering waypoints one at a time, adding waypoints along airways, and inserting departures, airways, arrivals, or approaches as needed. The system allows flight planning information to be entered from either the MFD or PFD. The flight plan is displayed on maps using different line widths, colors, and types, based on the type of leg and the segment of the flight plan currently being flown (departure, enroute, arrival, approach, or missed approach).

Flight Plan Leg Type	Symbol
Active non-heading Leg (TOPO On) Active non-heading Leg (TOPO Off)	
Active heading Leg (TOPO On) Active heading Leg (TOPO Off)	
Non-heading Leg in the current flight segment (TOPO On) Non-heading Leg in the current flight segment (TOPO Off)	
Heading Leg not in the current flight segment (TOPO On) Heading Leg not in the current flight segment (TOPO Off)	
Non-heading Leg not in the current flight segment (TOPO On) Non-heading Leg not in the current flight segment (TOPO Off)	
Turn Anticipation Arc (TOPO On/TOPO Off)	

Table 5-7 Flight Plan Leg Symbols

Up to 99 flight plans with up to 100 waypoints each can be created and stored in memory. One flight plan can be activated at a time and becomes the active flight plan. The active flight plan is erased when the system is turned off and overwritten when another flight plan is activated. When storing flight plans with an approach, departure, or arrival, the system uses the waypoint information from the current database to define the waypoints. If the database is changed or updated, the system automatically updates the information if the procedure has not been modified. If an approach, departure, or arrival procedure is no longer available, the procedure is deleted from the affected stored flight plan(s), and an alert is displayed (see Miscellaneous Messages in Appendix A) advising that one or more stored flight plans need to be edited.

Whenever an approach, departure, or arrival procedure is loaded into the active flight plan, a set of approach, departure, or arrival waypoints is inserted into the flight plan along with a header line describing the instrument procedure the pilot selected. The original enroute portion of the flight plan remains active (unless an instrument procedure is activated) when the procedure is loaded.

When the database is updated, the airways need to be reloaded also. Each airway segment is reloaded from the database given the entry waypoint, the airway identifier and the exit waypoint. This reloads the sequence of waypoints between the entry and exit waypoints (the sequence may change when the database is updated). The update of an airway can fail during this process. If that happens, the airway waypoints are changed to regular (non-airway) flight plan waypoints, and an alert is displayed (see Miscellaneous Messages in Appendix A).

The following could cause the airway update to fail:

- Airway identifier, entry waypoint or exit waypoint not found in the new database.
- Airway entry/exit waypoint is not an acceptable waypoint for the airway – either the waypoint is no longer on the airway, or there is a new directional restriction that prevents it being used.
- Loading the new airway sequence would exceed the capacity of the flight plan.

FLIGHT PLAN CREATION

There are three methods to create or modify a flight plan:

- Active Flight Plan Page on the MFD (create/modify the active flight plan)
- Active Flight Plan Window on the PFD (create/modify the active flight plan)
- Flight Plan Catalog Page on the MFD (create/modify a stored flight plan)

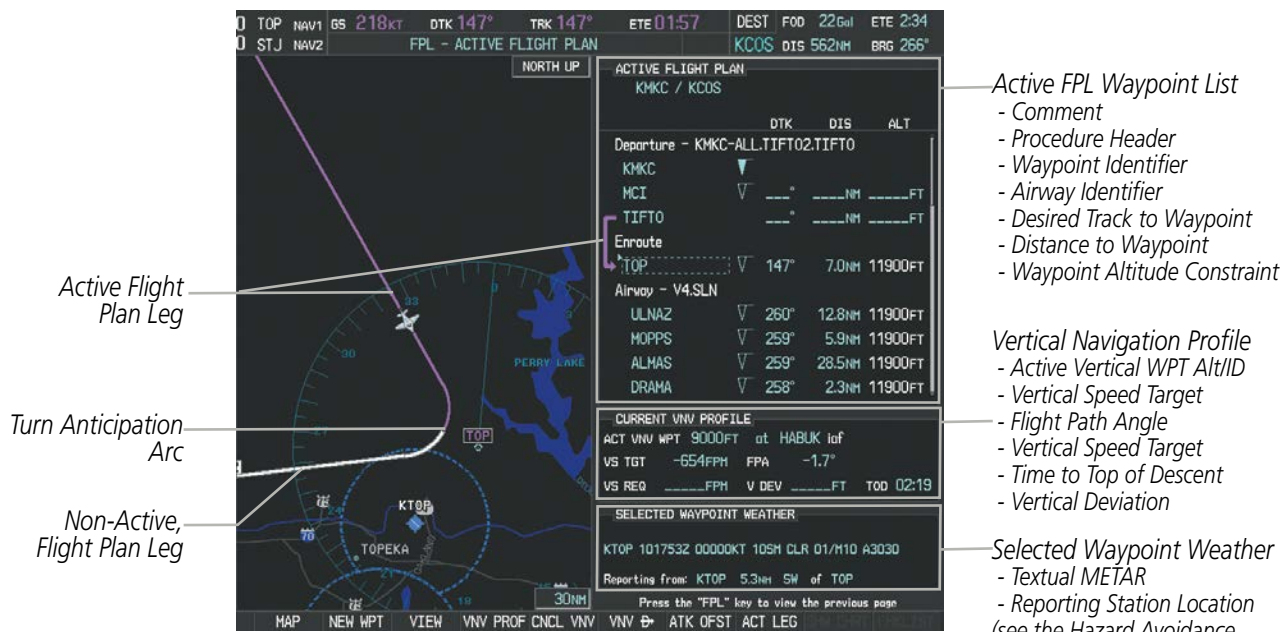

Figure 5-62 Active Flight Plan Page



Figure 5-63 Active Flight Plan Window on PFD

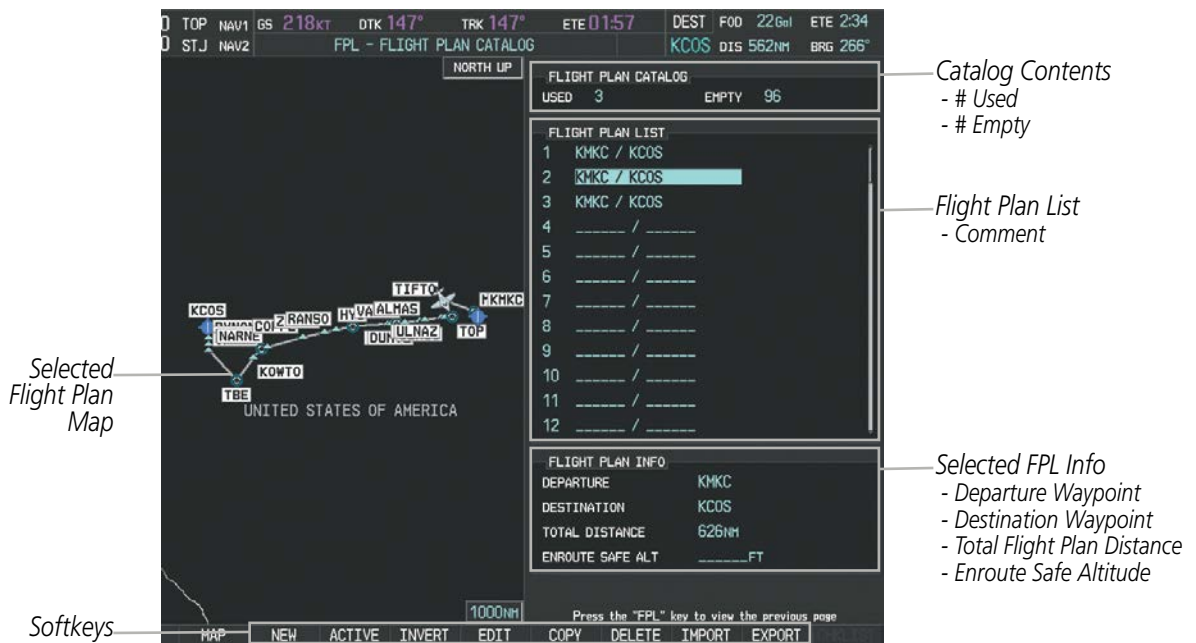

Figure 5-64 Flight Plan Catalog Page

The active flight plan is listed on the active Flight Plan Page on the MFD, and in the Active Flight Plan Window on the PFD. It is the flight plan to which Perspective is currently providing guidance, and is shown on the navigation maps. Stored flight plans are listed on the Flight Plan Catalog Page, and are available for activation (becomes the active flight plan).



NOTE: The system supports AFCS lateral guidance for all leg types (using NAV or FMS APPR mode). The system does not support course deviation for any heading leg types (VA, VD, VI, VM, or VR).

Creating an active flight plan with the FMS Knob:

- 1) Press the **FPL** Key.
- 2) Push the **FMS** Knob to activate the cursor (only on MFD).
- 3) Turn the small **FMS** Knob to display the Waypoint Information Window. (Turning it clockwise displays a blank Waypoint Information Window, turning it counter-clockwise displays the Waypoint Information Window with a waypoint selection submenu allowing selection of active flight plan, nearest, recent, user, or airway waypoints).
- 4) Enter the identifier, facility, or city name of the departure waypoint or select a waypoint from the submenu of waypoints and press the **ENT** Key. The active flight plan is modified as each waypoint is entered.
- 5) Repeat step numbers 3 and 4 to enter each additional flight plan waypoint.
- 6) When all waypoints have been entered, push the **FMS** Knob to remove the cursor.

Creating an active flight plan with the Quick Select Box:

- 1) Press the **FPL** Key.
- 2) Enter the identifier, facility, or city name of the departure waypoint using the alphanumeric keys on the PFD/MFD Control Unit and press the **ENT** Key. The active flight plan is modified as each waypoint is entered.
- 3) Repeat step number 2 to enter each additional flight plan waypoint.

Creating a stored flight plan with the FMS Knob:

- 1) Press the **FPL** Key.
- 2) Turn the small **FMS** Knob clockwise to display the Flight Plan Catalog Page.
- 3) Press the **NEW** Softkey; or press the **MENU** Key, highlight 'Create New Flight Plan', and press the **ENT** Key to display a blank flight plan for the first empty storage location.
- 4) Turn the small **FMS** Knob to display the Waypoint Information Window. (Turning it clockwise displays a blank Waypoint Information Window, turning it counter-clockwise displays the Waypoint Information Window with a waypoint selection submenu allowing selection of active flight plan, nearest, recent, user, or airway waypoints).
- 5) Enter the identifier, facility, or city name of the departure waypoint or select a waypoint from the submenu of waypoints and press the **ENT** Key.
- 6) Repeat step numbers 4 and 5 to enter each additional flight plan waypoint.
- 7) When all waypoints have been entered, push the **FMS** Knob to return to the Flight Plan Catalog Page. The new flight plan is now in the list.

Flight plans can be imported from an SD Card or exported to an SD Card from the Stored Flight Plan Page.

Importing a Flight Plan from an SD Card

- 1) Insert the SD card containing the flight plan in the top card slot on the MFD.
- 2) Press the **FPL** Key on the Control Unit to display the Active Flight Plan Page on the MFD.
- 3) Turn the small **FMS** Knob to select the Flight Plan Catalog Page.

- 4) Push the **FMS** Knob to activate the cursor.
- 5) Turn either **FMS** Knob to highlight an empty or existing flight plan.
- 6) Press the **IMPORT** Softkey; or press the **MENU** Key, select "Import Flight Plan", and press the **ENT** Key.
If an empty slot is selected, a list of the available flight plans on the SD card will be displayed.

Or:

If an existing flight plan is selected, an "Overwrite existing flight plan? OK or CANCEL" prompt is displayed. Press the **ENT** Key to choose to overwrite the selected flight plan and see the list of available flight plans on the SD card. If overwriting the existing flight plan is not desired, select "CANCEL" using the **FMS** Knob, press the **ENT** Key, select another flight plan slot, and press the **IMPORT** Softkey again.

- 7) Turn the small **FMS** Knob to highlight the desired flight plan for importing.
- 8) Press the **ENT** Key to initiate the import.
- 9) Press the **ENT** Key again to confirm the import.



NOTE: If the imported flight plan contains a waypoint with a name that duplicates the name of a waypoint already stored on the system, the system compares the coordinates of the imported waypoint with those of the existing waypoint. If the coordinates are different, the imported waypoint is automatically renamed by adding characters to the end of the name.



Import/Export Softkeys

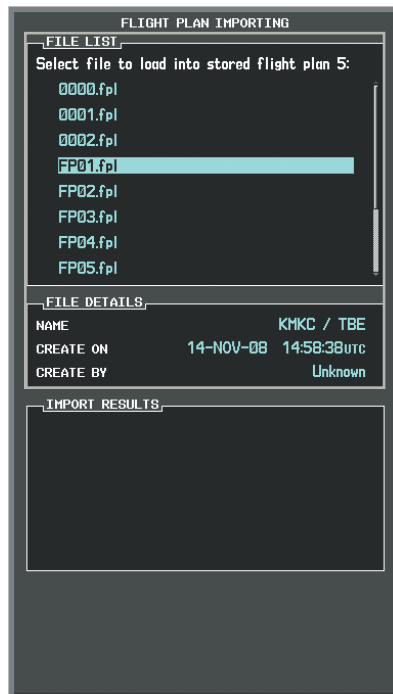

List of Flight Plans to Import & Details for the Selected File

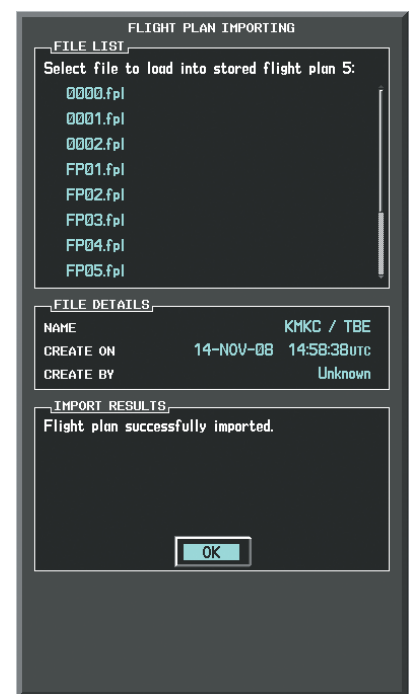

Import Successful

Figure 5-65 Flight Plan Import

Exporting a Flight Plan to an SD Card

- 1) Insert the SD card into the top card slot on the MFD.
- 2) Press the **FPL** Key on the Control Unit to display the Active Flight Plan Page on the MFD.
- 3) Turn the small **FMS** Knob to select the Flight Plan Catalog Page.
- 4) Push the **FMS** Knob to activate the cursor.
- 5) Turn the large **FMS** Knob to highlight the flight plan to be exported.
- 6) Press the **EXPORT** Softkey; or press the **MENU** Key, select "Export Flight Plan".
- 7) If desired, change the name for the exported file by turning the large **FMS** Knob to the left to highlight the name, then use the small and large **FMS** knobs to enter the new name, and press the **ENT** Key.
- 8) Press the **ENT** Key to initiate the export.
- 9) Press the **ENT** Key to confirm the export.



NOTE: The exported flight plan will not contain any procedures or airways.



Import/Export Softkeys

Stored Flight Plan to be Exported & Exported Flight Plan Name

Export Successful

Figure 5-66 Flight Plan Export

Flight plans can be transferred to the system from a mobile device via the Flight Stream 210 Bluetooth wireless connection.

Previewing a pending flight plan transfer from a wireless connection:

- 1) When a flight plan transfer has been initiated from a mobile device, a Pending Flight Plan pop-up alert appears in the lower right corner of the MFD, and an Connex action annunciation appears to the right of the MFD page name.
- 2) Press the **ENT** Key to display the Preview Flight Plan Page on the MFD.

Or:

Press the **PREVIEW** Softkey to display the Preview Flight Plan Page on the MFD.

Or:

Press the **MENU** Key, select 'Preview Flight Plan', and press the **ENT** Key. The Preview Flight Plan Page is displayed.

Ignoring a pending flight plan transfer from a wireless connection:

- 1) When a flight plan transfer has been initiated from a mobile device, a Pending Flight Plan pop-up alert appears in the lower right corner of the MFD, and an Connex action annunciation appears to the right of the MFD page name.
- 2) Press the **CLR** Key to remove the pop-up alert and ignore the pending flight plan. The pending flight plan will still be available on the Flight Plan Catalog page.

Or:

Press the **IGNORE** Softkey to remove the pop-up alert and ignore the pending flight plan. The pending flight plan will still be available on the Flight Plan Catalog page.



Figure 5-67 Pending Flight Plan Transfer



Figure 5-68 Preview Flight Plan Page

Storing a pending flight plan:

- 1) Press the **FPL** Key and turn the small **FMS** Knob to display the Flight Plan Catalog Page.
- 2) Push the **FMS** Knob to activate the cursor, and turn the **FMS** Knob to highlight the pending flight plan.
- 3) Press the **ENT** Key to display the Preview Flight Plan Page on the MFD.
- 4) Press the **STORE** Softkey to store the flight plan.
Or:
 Push the **FMS** Knob to activate the cursor, and turn the **FMS** Knob to highlight 'STORE?'. Press the **ENT** Key to store the flight plan.
Or:
 Press the **MENU** Key, select 'Store Flight Plan', and press the **ENT** Key to store the flight plan.
- 5) The pending flight plan is stored and the pending annunciation is removed.

Activating a pending flight plan:

- 1) Press the **FPL** Key and turn the small **FMS** Knob to display the Flight Plan Catalog Page.
- 2) Push the **FMS** Knob to activate the cursor, and turn the **FMS** Knob to highlight the pending flight plan.
- 3) Press the **ENT** Key to display the Preview Flight Plan Page on the MFD.
- 4) Press the **ACTIVATE** Softkey to activate the flight plan.
Or:
 Push the **FMS** Knob to activate the cursor, and turn the **FMS** Knob to highlight 'ACTIVATE?'. Press the **ENT** Key to activate the flight plan.
Or:
 Press the **MENU** Key, select 'Activate Flight Plan', and press the **ENT** Key to activate the flight plan.
- 5) The pending flight plan becomes the active flight plan and is removed from the Flight Plan Catalog Page.

Deleting a pending flight plan:

- 1) Press the **FPL** Key and turn the small **FMS** Knob to display the Flight Plan Catalog Page.
- 2) Push the **FMS** Knob to activate the cursor, and turn the **FMS** Knob to highlight the desired pending flight plan.
- 3) Press the **DELETE** Softkey; press the **CLR** Key; or press the **MENU** Key, highlight 'Delete Flight Plan', and press the **ENT** Key. The 'Delete Flight Plan XX?' window is displayed.
- 4) With 'OK' highlighted, press the **ENT** Key to delete the pending flight plan. To cancel the request, press the **CLR** Key, or highlight 'CANCEL' and press the **ENT** Key.

Deleting all pending flight plans:

- 1) Press the **FPL** Key and turn the small **FMS** Knob to display the Flight Plan Catalog Page.
- 2) Press the **MENU** Key.
- 3) Highlight 'Delete All Pending' and press the **ENT** Key. A 'Delete all pending flight plans?' confirmation window is displayed.
- 4) With 'OK' highlighted, press the **ENT** Key to delete all pending flight plans. To cancel the request, press the **CLR** Key, or highlight 'CANCEL' and press the **ENT** Key.

ADDING WAYPOINTS TO AN EXISTING FLIGHT PLAN

Waypoints can be added to the active flight plan or any stored flight plan. Choose the flight plan, select the desired point of insertion, enter the waypoint, and it is added in front of the selected waypoint. Flight plans are limited to 100 waypoints (including waypoints within airways and procedures). If the number of waypoints in the flight plan exceeds 100, the message "Flight plan is full. Remove unnecessary waypoints." appears and the new waypoint(s) are not added to the flight plan.

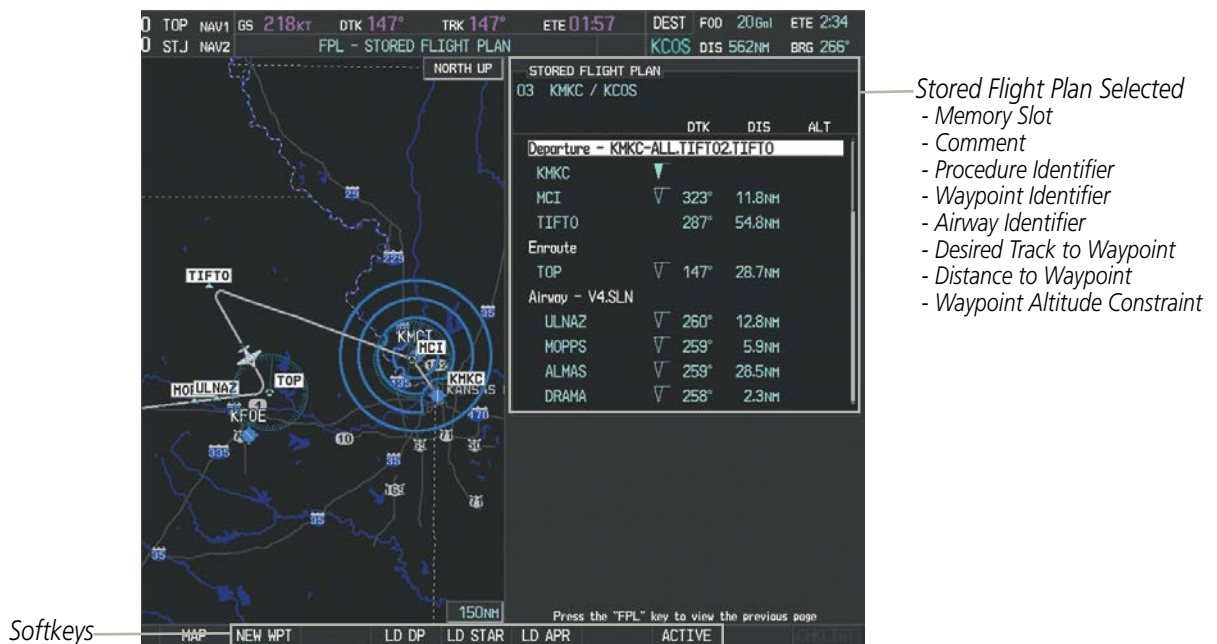

Figure 5-69 Stored Flight Plan Page

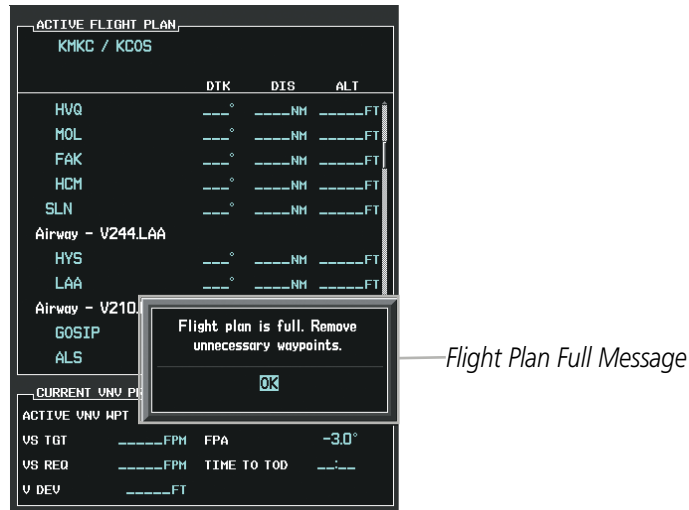

Figure 5-70 Active Flight Plan Page - FPL Full

Adding a waypoint to a stored flight plan:

- 1) On the Flight Plan Catalog Page, push the **FMS** Knob to activate the cursor.
- 2) Highlight the desired flight plan.
- 3) Press the **EDIT** Softkey; or press the **ENT** Key, turn the large **FMS** Knob clockwise to select "EDIT" and press the **ENT** Key. The Stored Flight Plan Page is displayed.
- 4) Select the point in the flight plan to add the new waypoint. The new waypoint is placed directly in front of the highlighted waypoint.
- 5) Turn the small **FMS** Knob to display the Waypoint Information Window. (Turning it clockwise displays a blank Waypoint Information Window, turning it counter-clockwise displays the Waypoint Information Window with a waypoint selection submenu allowing selection of active flight plan, nearest, recent, user, or airway waypoints).
- 6) Enter the identifier, facility, or city name of the waypoint or select a waypoint from the submenu of waypoints and press the **ENT** Key. The new waypoint now exists in the flight plan.



NOTE: If the identifier entered in the Waypoint Information Window has duplicates, a Duplicate Waypoint Window is displayed. Use the FMS Knob to select the correct waypoint.



Figure 5-71 Duplicate Waypoints Window

Adding a waypoint to the active flight plan using the FMS Knob:

- 1) Press the **FPL** Key.
- 2) Push the **FMS** Knob to activate the cursor (not required on the PFD).
- 3) Select the point in the flight plan before which to add the new waypoint. The new waypoint is placed directly in front of the highlighted waypoint.
- 4) Turn the small **FMS** Knob to display the Waypoint Information Window. (Turning it clockwise displays a blank Waypoint Information Window, turning it counter-clockwise displays the Waypoint Information Window with a waypoint selection submenu allowing selection of active flight plan, nearest, recent, user, or airway waypoints).
- 5) Enter the identifier, facility, or city name of the waypoint or select a waypoint from the submenu of waypoints and press the **ENT** Key. The active flight plan is modified as each waypoint is entered.

Adding a waypoint to the active flight plan using the Quick Select Box:

- 1) Press the **FPL** Key.
- 2) Use the Joystick to position the Quick Select Box and the associated Insertion Point Indicator at the location to insert the waypoint.
- 3) Enter the identifier, facility, or city name of the waypoint using the alphanumeric keys on the PFD/MFD Control Unit and press the **ENT** Key. The active flight plan is modified as each waypoint is entered.

Creating and adding user waypoints to the active flight plan:

- 1) Press the **Joystick** to activate the panning function on the Active Flight Plan Page and pan to the map location of the desired user waypoint.
- 2) Press the **LD WPT** Softkey; or press the **MENU** Key, select 'Load Waypoint', and press the **ENT** Key. The user waypoint is created with a name of USRxxx (using the next available in sequence) and is added to the end of the active flight plan.

ADDING AIRWAYS TO A FLIGHT PLAN

Airways can be added to the active flight plan or any stored flight plan. Choose a flight plan (add the desired airway entry point if not already in the flight plan), select the waypoint after the desired airway entry point, select the airway, and it is added in front of the selected waypoint. An airway can only be loaded if there is a waypoint in the flight plan that is part of the desired airway and is not part of an arrival or approach procedure. Perspective also anticipates the desired airway and exit point based on loaded flight plan waypoints.



Figure 5-72 Select Airway Page - Selecting Airway

Adding an airway to a flight plan using the FMS Knob:

- 1) Press the **FPL** Key.
- 2) Push the **FMS** Knob to activate the cursor (not required on the PFD).
- 3) Turn the large **FMS** Knob to highlight the waypoint after the desired airway entry point. If this waypoint is not a valid airway entry point, a valid entry point should be entered at this time.
- 4) Turn the small **FMS** Knob one click clockwise and press the **LD AIRWY** Softkey, or press the **MENU** Key and select "Load Airway". The Select Airway Page is displayed. The **LD AIRWY** Softkey or the "Load Airway" menu item is available only when a valid airway entry waypoint has been chosen (the waypoint ahead of the cursor position).
- 5) Turn the **FMS** Knob to select the desired airway from the list, and press the **ENT** Key. Low altitude airways are shown first in the list, followed by "all" altitude airways, and then high altitude airways.
- 6) Turn the **FMS** Knob to select the desired airway exit point from the list, and press the **ENT** Key. 'LOAD?' is highlighted.
- 7) Press the **ENT** Key. The system returns to editing the flight plan with the new airway inserted.

Adding an airway to a flight plan using the Quick Select Box:

- 1) Press the **FPL** Key.
- 2) Use the Joystick to place the QuickSelect Box on the waypoint after the desired airway entry point. If this waypoint is not a valid airway entry point, a valid entry point should be entered at this time.
- 3) Press the **MENU** Key and select "Load Airway". The Select Airway Page is displayed.
- 4) Turn the **FMS** Knob to select the desired airway from the list, and press the **ENT** Key. Low altitude airways are shown first in the list, followed by "all" altitude airways, and then high altitude airways.
- 5) Turn the **FMS** Knob to select the desired airway exit point from the list, and press the **ENT** Key. 'LOAD?' is highlighted.
- 6) Press the **ENT** Key. The system returns to editing the flight plan with the new airway inserted.

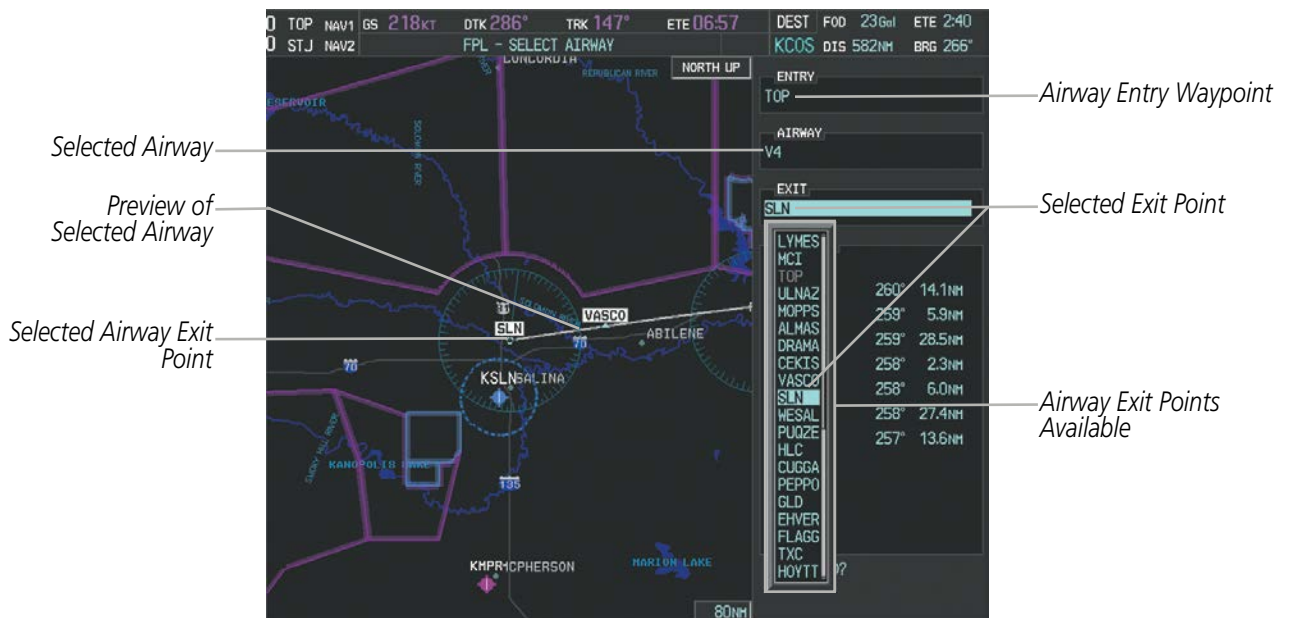

Figure 5-73 Select Airway Page - Selecting Exit Point

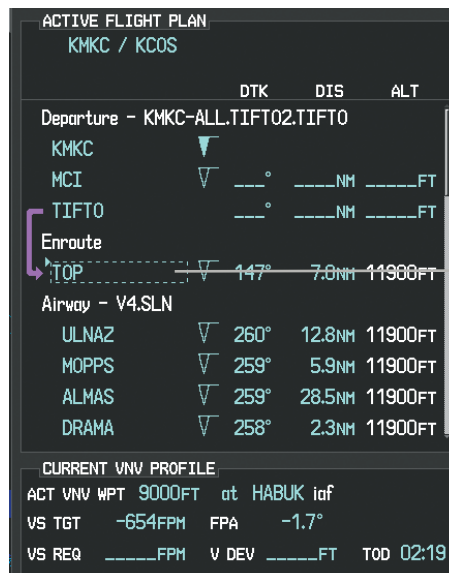

Figure 5-74 Active Flight Plan Page - Airway Inserted

RESTRICTIONS ON ADDING AIRWAYS

Some airways have directional restrictions on all or part of the route. Airway “A2” in Europe has a directional restriction over the whole route such that it can be flown only in the direction MTD-ABB-BNE-DEVAL.

Airway “UR975” in North Africa has more complicated directional restrictions within the list of airway waypoints AMANO, VAKOR, LIBRO, NELDA, DIRKA, GZO, KOSET, and SARKI:

- Starting from AMANO, the airway can be flown only to LIBRO.
- Starting from SARKI, the airway can be flown only to LIBRO.
- Between NELDA and GZO, the airway can be flown in either direction.

In the US, airways that are “one-way” for specified hours of operation are not uncommon. These airways are always bidirectional in the system database.

The system only allows correct airway sequences to be inserted. If the pilot subsequently inverts the flight plan, the system inverts the airway waypoint sequence and removes the airway header.

ADDING PROCEDURES TO A STORED FLIGHT PLAN

Perspective allows the pilot to insert pre-defined instrument procedures from the navigation database into a flight plan. The procedures are designed to facilitate routing of traffic leaving an airport (departure), arriving at an airport (arrival), and landing at an airport (approach). See the procedures section for more details.

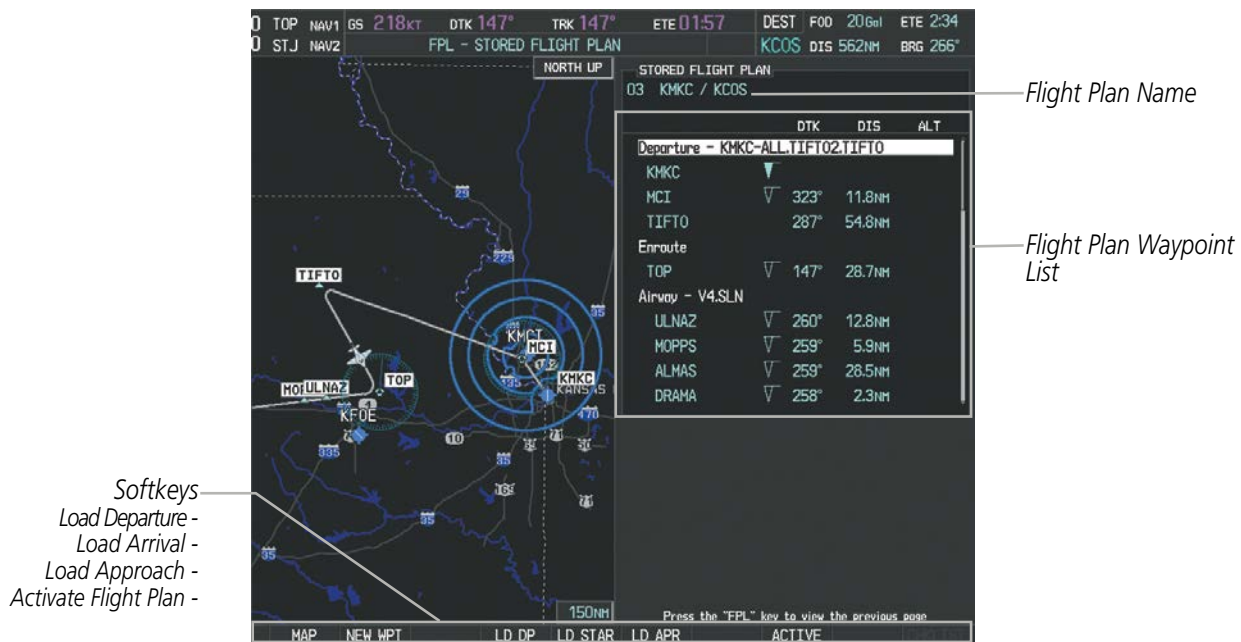

Figure 5-75 Stored Flight Plan Page

DEPARTURE (DP)

A Departure Procedure (DP) is loaded at the departure airport in the flight plan. Only one departure can be loaded at a time in a flight plan. The route is defined by selection of a departure, the transition waypoints, and a runway.

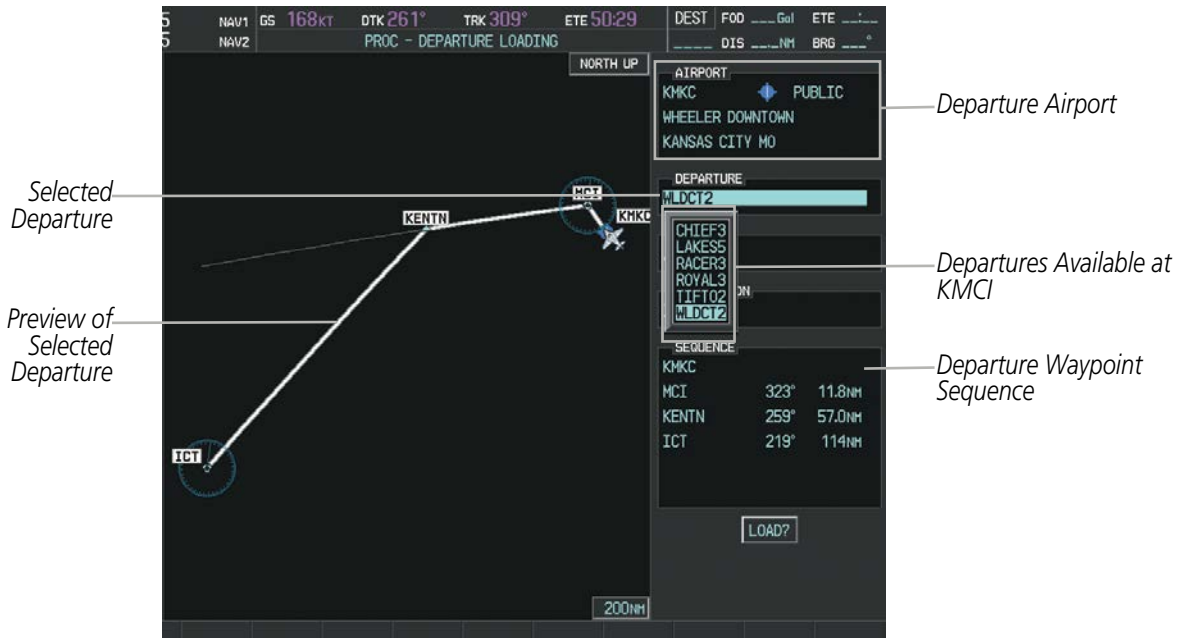

Figure 5-76 Departure Loading Page - Selecting the Departure

Loading a departure procedure into a stored flight plan:

- 1) Select a stored flight plan from the Flight Plan Catalog Page.
- 2) Press the **EDIT** Softkey; or press the **MENU** Key, select 'Edit Flight Plan', and press the **ENT** Key. The Stored Flight Plan Page is displayed.
- 3) Press the **LD DP** Softkey; or press the **MENU** Key, select "Load Departure", and press the **ENT** Key. The Departure Loading Page is displayed.
- 4) Select a departure. Press the **ENT** Key.
- 5) Select a runway served by the selected departure, if required. Press the **ENT** Key.
- 6) Select a transition for the selected departure. Press the **ENT** Key.
- 7) Press the **ENT** Key to load the selected departure procedure.

- SYSTEM OVERVIEW
- FLIGHT INSTRUMENTS
- EIS
- AUDIO PANEL & CNS
- FLIGHT MANAGEMENT
- HAZARD AVOIDANCE
- AFCS
- ADDITIONAL FEATURES
- APPENDICES
- INDEX

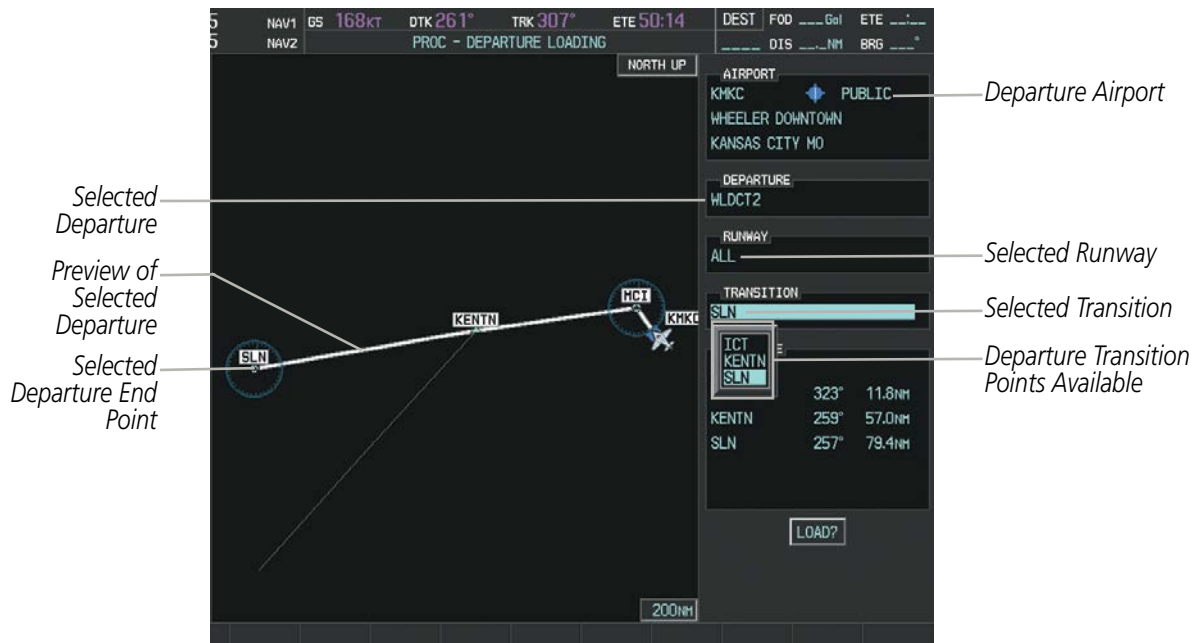

Figure 5-77 Departure Loading Page - Selecting Transition

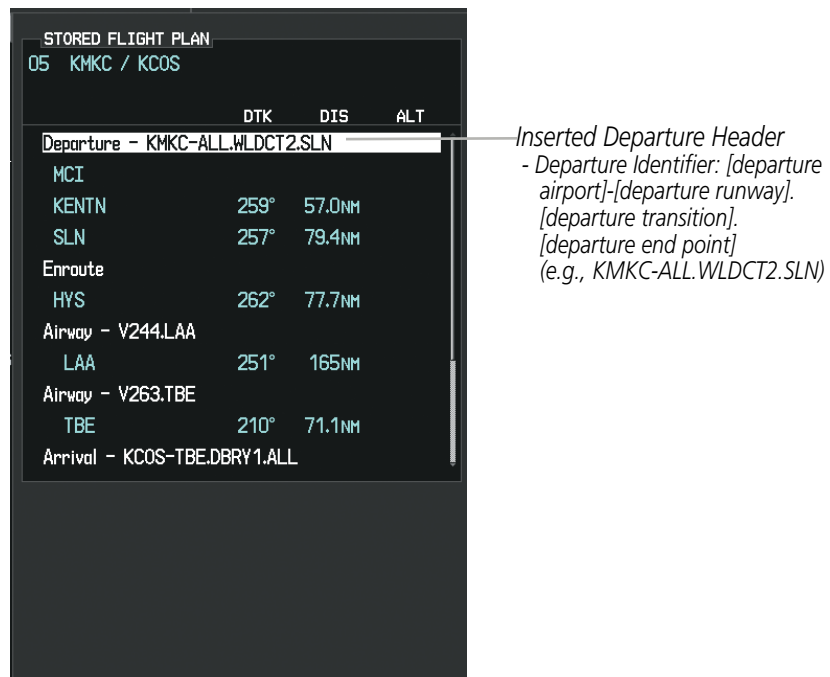

Figure 5-78 Stored Flight Plan Page - Departure Inserted

ARRIVAL (STAR)

A Standard Terminal Arrival (STAR) is loaded at the destination airport in the flight plan. Only one arrival can be loaded at a time in a flight plan. The route is defined by selection of an arrival, the transition waypoints, and a runway.

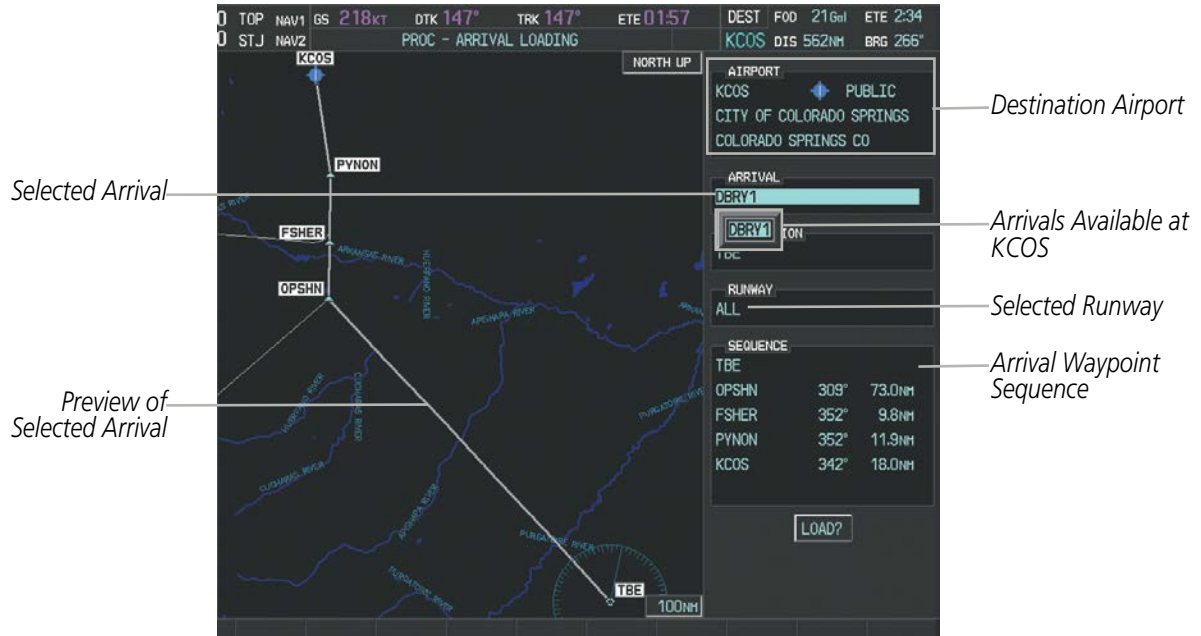

Figure 5-79 Arrival Loading Page - Selecting the Arrival

Loading an arrival procedure into a stored flight plan:

- 1) Select a stored flight plan from the Flight Plan Catalog Page.
- 2) Press the **EDIT** Softkey; or press the **MENU** Key, select 'Edit Flight Plan', and press the **ENT** Key. The Stored Flight Plan Page is displayed.
- 3) Press the **LD STAR** Softkey; or press the **MENU** Key, select "Load Arrival", and press the **ENT** Key. The Arrival Loading Page is displayed.
- 4) Select an arrival. Press the **ENT** Key.
- 5) Select a transition for the selected arrival. Press the **ENT** Key.
- 6) Select a runway served by the selected arrival, if required. Press the **ENT** Key.
- 7) Press the **ENT** Key to load the selected arrival procedure.

- SYSTEM OVERVIEW
- FLIGHT INSTRUMENTS
- EIS
- AUDIO PANEL & CNS
- FLIGHT MANAGEMENT
- HAZARD AVOIDANCE
- AFCS
- ADDITIONAL FEATURES
- APPENDICES
- INDEX

Destination Airport

Selected Arrival

Preview of Selected Arrival

Selected Transition

Transitions Available with DBRY1

Arrival Waypoint Sequence

SEQUENCE	Waypoint	Heading	Distance
TBE			
OPSHN		309°	73.0NM
FSHER		352°	9.8NM
PYNON		352°	11.9NM
KCOS		342°	18.0NM

Figure 5-80 Arrival Loading Page - Selecting the Transition

STORED FLIGHT PLAN

06 KMKC / KCOS

	DTK	DIS	ALT
HYS	262°	77.7NM	
Airway - V244.LAA			
LAA	251°	165NM	
Airway - V263.TBE			
TBE	210°	71.1NM	
Arrival - KCOS-TBE.DBRY1.ALL			
OPSHN	309°	73.0NM	
FSHER	352°	9.8NM	
PYNON	352°	11.9NM	
KCOS	342°	18.0NM	

Inserted Arrival Header
- Arrival Identifier:
[arrival airport]-[arrival transition].
[arrival].[arrival runway]
(e.g., KCOS-TBE.DBRY1.ALL)

Figure 5-81 Stored Flight Plan Page - Arrival Inserted

APPROACH (APPR)

An Approach Procedure (APPR) can be loaded at any airport that has an approach available. Only one approach can be loaded at a time in a flight plan. The route for a selected approach is defined by designating transition waypoints.

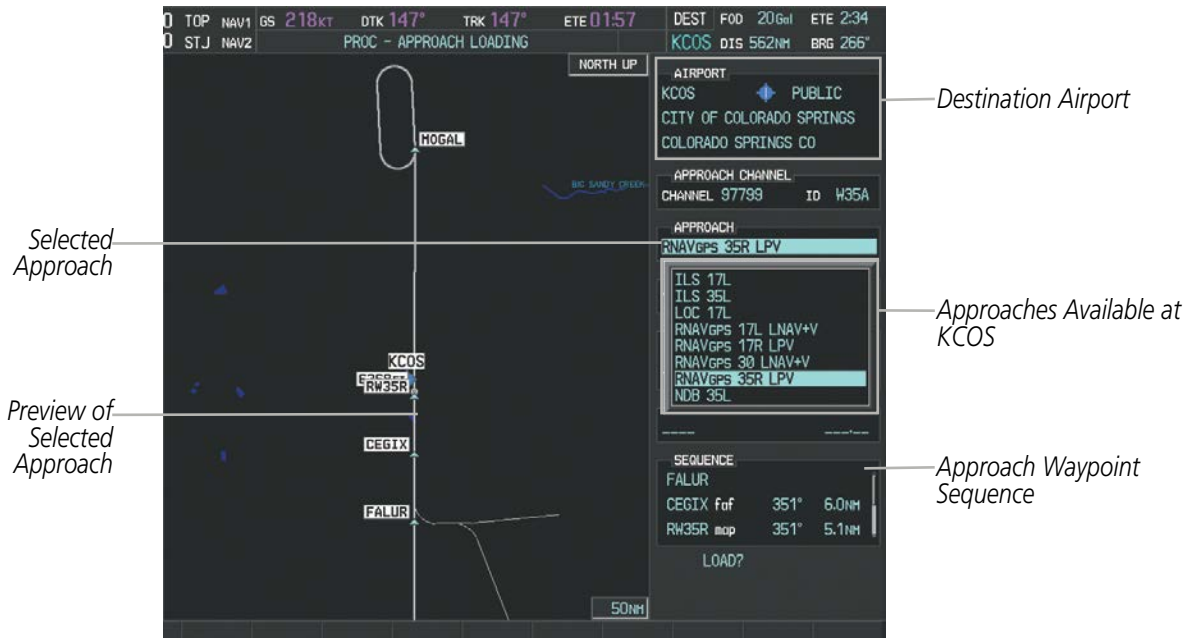

Figure 5-82 Approach Loading Page - Selecting the Approach

Loading an approach procedure into a stored flight plan:

- 1) Select a stored flight plan from the Flight Plan Catalog Page.
- 2) Press the **EDIT** Softkey; or press the **MENU** Key, select 'Edit Flight Plan', and press the **ENT** Key. The Stored Flight Plan Page is displayed.
- 3) Press the **LD APR** Softkey; or press the **MENU** Key, select "Load Approach", and press the **ENT** Key. The Approach Loading Page is displayed.
- 4) Select the airport and approach:
 - a) Use the **FMS** Knob to select an airport and press the **ENT** Key.
 - b) Select an approach from the list and press the **ENT** Key.

Or:

 - a) If necessary, push the **FMS** Knob to exit the approach list, and use the large **FMS** Knob to move the cursor to the APPROACH CHANNEL field.
 - b) Use the **FMS** Knob to enter the approach channel number, and press the **ENT** Key to accept the approach channel number. The airport and approach are selected.
- 5) Select a transition for the selected approach. Press the **ENT** Key.
- 6) Press the **ENT** Key to load the selected approach procedure.

- SYSTEM OVERVIEW
- FLIGHT INSTRUMENTS
- EIS
- AUDIO PANEL & CNS
- FLIGHT MANAGEMENT
- HAZARD AVOIDANCE
- AFCS
- ADDITIONAL FEATURES
- APPENDICES
- INDEX

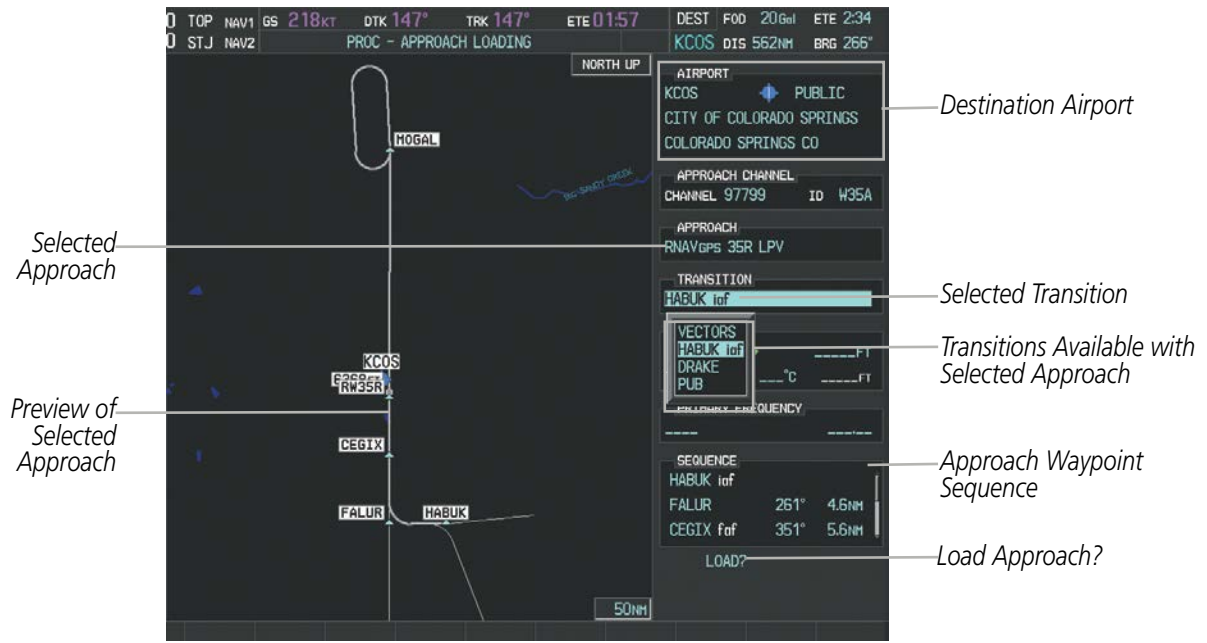

Figure 5-83 Approach Loading Page - Selecting the Transition

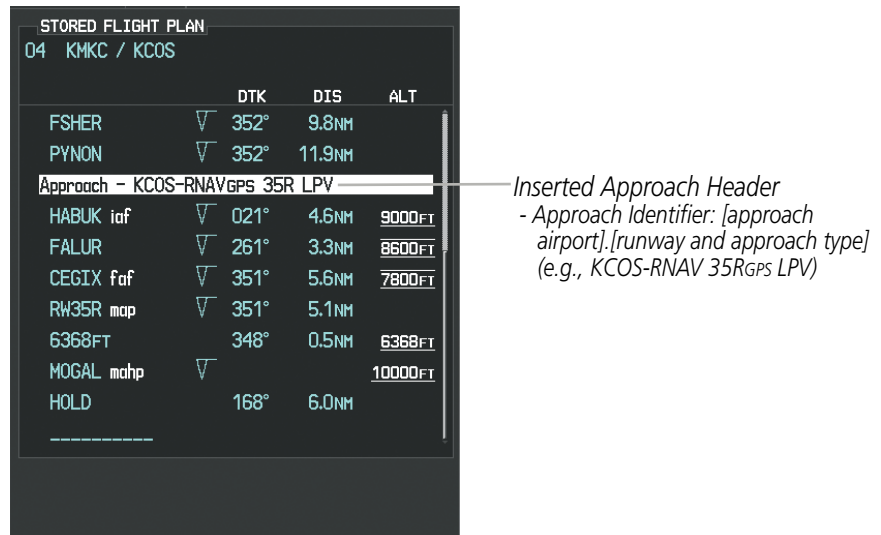

Figure 5-84 Stored Flight Plan Page - Approach Inserted

FLIGHT PLAN STORAGE

Perspective can store up to 99 flight plans, numbered 1 through 99. The active flight plan is erased when the system is powered off or when another flight plan is activated. Details about each stored flight plan can be viewed on the Flight Plan Catalog Page and on the Stored Flight Plan Page.

Viewing information about a stored flight plan:

- 1) Press the **FPL** Key on the MFD to display the Active Flight Plan Page.
- 2) Turn the small **FMS** Knob clockwise to display the Flight Plan Catalog Page.
- 3) Push the **FMS** Knob to activate the cursor and turn the **FMS** Knob to highlight the desired flight plan.
- 4) The Flight Plan Information is displayed showing departure, destination, total distance, and enroute safe altitude information for the selected Flight Plan.
- 5) Press the **EDIT** Softkey to open the Stored Flight Plan Page and view the waypoints in the flight plan.
- 6) Push the **FMS** Knob to exit the Stored Flight Plan Page.

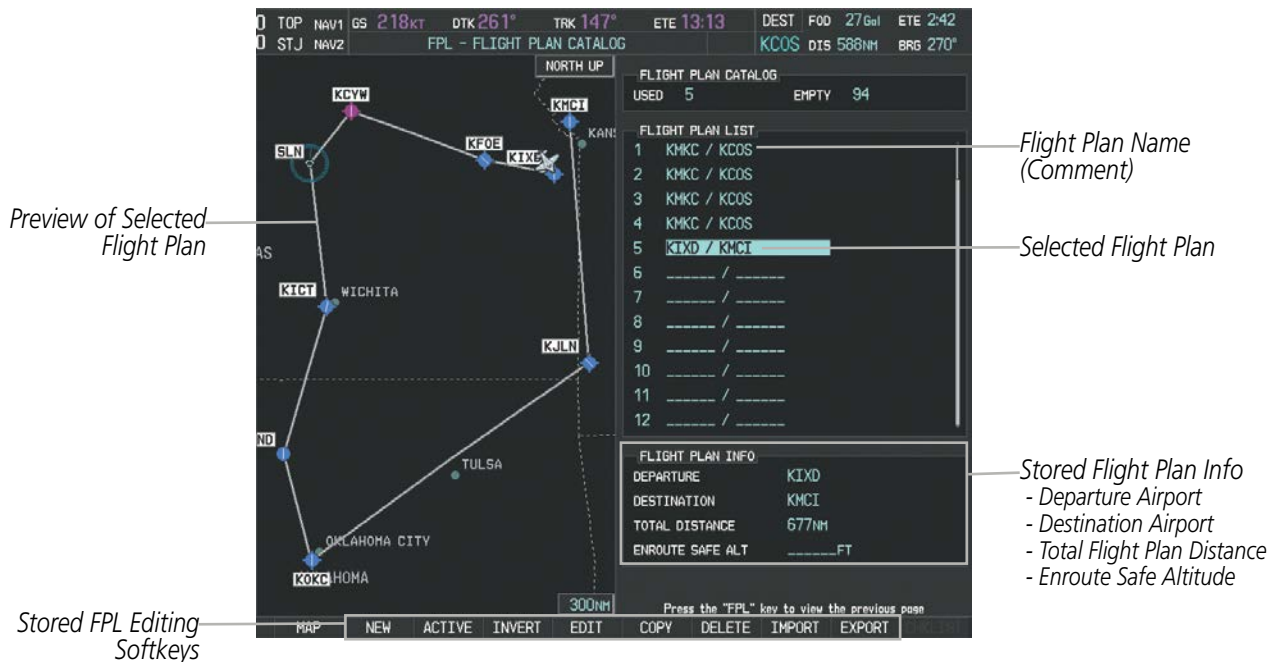

Figure 5-85 Stored Flight Plan Information

Storing an active flight plan from the Active Flight Plan Page or the Active Flight Plan Window:

- 1) Press the **MENU** Key.
- 2) Highlight 'Store Flight Plan'.
- 3) Press the **ENT** Key.
- 4) With 'OK' highlighted, press the **ENT** Key. The flight plan is stored in the next available position in the flight plan list on the Flight Plan Catalog Page.

ACTIVATE A FLIGHT PLAN

Activating a stored flight plan erases the active flight plan and replaces it with the flight plan being activated. Inverting a stored flight plan reverses the waypoint order, erases the active flight plan, and replaces it with the flight plan being activated (the stored flight plan is not changed).

Activating a stored flight plan on the MFD:

- 1) Press the **FPL** Key and turn the small **FMS** Knob to display the Flight Plan Catalog Page.
- 2) Push the **FMS** Knob to activate the cursor, and turn the **FMS** Knob to highlight the desired flight plan.
- 3) Press the **ACTIVE** Softkey; or press the **ENT** Key twice; or press the **MENU** Key, highlight 'Activate Flight Plan', and press the **ENT** Key. The 'Activate Stored Flight Plan?' window is displayed.
- 4) With 'OK' highlighted, press the **ENT** Key. To cancel the request, press the **CLR** Key, or highlight 'CANCEL' and press the **ENT** Key.

Inverting and activating a stored flight plan on the MFD:

- 1) Press the **FPL** Key and turn the small **FMS** Knob to display the Flight Plan Catalog Page.
- 2) Push the **FMS** Knob to activate the cursor, and turn the **FMS** Knob to highlight the desired flight plan.
- 3) Press the **INVERT** Softkey; or press the **MENU** Key, highlight 'Invert & Activate FPL?', and press the **ENT** Key. The 'Invert and activate stored flight plan?' window is displayed.
- 4) With 'OK' highlighted, press the **ENT** Key. To cancel the request, press the **CLR** Key, or highlight 'CANCEL' and press the **ENT** Key.

COPY A FLIGHT PLAN

Perspective allows copying a flight plan into a new flight plan memory slot, allowing editing, etc., without affecting the original flight plan. This can be used to duplicate an existing stored flight plan for use in creating a modified version of the original stored flight plan.

Copying a stored flight plan on the MFD:

- 1) Press the **FPL** Key and turn the small **FMS** Knob to display the Flight Plan Catalog Page.
- 2) Push the **FMS** Knob to activate the cursor, and turn the **FMS** Knob to highlight the desired flight plan.
- 3) Press the **COPY** Softkey; or press the **MENU** Key, highlight 'Copy Flight Plan', and press the **ENT** Key. The 'Copy to Flight Plan XX?' window is displayed.
- 4) With 'OK' highlighted, press the **ENT** Key to copy the flight plan. To cancel the request, press the **CLR** Key, or highlight 'CANCEL' and press the **ENT** Key.

DELETE A STORED FLIGHT PLAN

Individual or all stored flight plans can be deleted from the system memory.

Deleting a stored flight plan:

- 1) Press the **FPL** Key and turn the small **FMS** Knob to display the Flight Plan Catalog Page.
- 2) Push the **FMS** Knob to activate the cursor, and turn the **FMS** Knob to highlight the desired flight plan.
- 3) Press the **DELETE** Softkey; press the **CLR** Key; or press the **MENU** Key, highlight 'Delete Flight Plan', and press the **ENT** Key. The 'Delete Flight Plan XX?' window is displayed.
- 4) With 'OK' highlighted, press the **ENT** Key to delete the flight plan. To cancel the request, press the **CLR** Key, or highlight 'CANCEL' and press the **ENT** Key.



NOTE: The option to delete all stored flight plans is not available while the aircraft is in flight.

Deleting all stored flight plans:

- 1) Press the **FPL** Key and turn the small **FMS** Knob to display the Flight Plan Catalog Page.
- 2) Press the **MENU** Key.
- 3) Highlight 'Delete All' and press the **ENT** Key. A 'Delete all flight plans?' confirmation window is displayed.
- 4) With 'OK' highlighted, press the **ENT** Key to delete all flight plans. To cancel the request, press the **CLR** Key, or highlight 'CANCEL' and press the **ENT** Key.

FLIGHT PLAN EDITING

The active flight plan or any stored flight plan can be edited. The edits made to the active flight plan affect navigation as soon as they are entered.

DELETING THE ACTIVE FLIGHT PLAN

Perspective allows deleting an active flight plan. Deleting the active flight plan suspends navigation by the system.

Deleting the active flight plan:

- 1) Press the **FPL** Key to display the Active Flight Plan Page (MFD) or the Active Flight Plan Window (PFD).
- 2) Press the **MENU** Key, highlight 'Delete Flight Plan', and press the **ENT** Key. The 'Delete all waypoints in flight plan?' window is displayed.
- 3) With 'OK' highlighted, press the **ENT** Key to delete the active flight plan. To cancel the request, press the **CLR** Key, or highlight 'CANCEL' and press the **ENT** Key.

DELETING FLIGHT PLAN ITEMS

Individual waypoints, entire airways, and entire procedures can be deleted from a flight plan. Some waypoints in the final approach segment (such as the FAF or MAP) can not be deleted individually. Attempting to delete a waypoint that is not allowed results in a window displaying 'Invalid flight plan modification.'

Deleting an individual waypoint from the active flight plan:

- 1) Press the **FPL** Key to display the Active Flight Plan Page (MFD) or the Active Flight Plan Window (PFD).
- 2) Push the **FMS** Knob to activate the cursor (not required on the PFD) and turn the large **FMS** Knob to highlight the waypoint to be deleted.

Or:

Use the Joystick to place the Quick Select Box on the waypoint to be deleted (MFD only).

- 3) Press the **CLR** Key. The 'Remove XXXXX?' window is displayed.
- 4) With 'OK' highlighted, press the **ENT** Key. To cancel the request, press the **CLR** Key, or highlight 'CANCEL' and press the **ENT** Key.
- 5) Push the **FMS** Knob to remove the flashing cursor, if required.

Deleting an entire airway from the active flight plan:

- 1) Press the **FPL** Key to display the Active Flight Plan Page (MFD) or the Active Flight Plan Window (PFD).
- 2) Push the **FMS** Knob to activate the cursor (not required on the PFD) and turn the large **FMS** Knob to highlight the white header of the airway to be deleted.

Or:

Use the Joystick to place the Quick Select Box on the white header of the airway to be deleted (MFD only).

- 3) Press the **CLR** Key. The 'Remove <airway name>?' window is displayed.
- 4) With 'OK' highlighted, press the **ENT** Key. To cancel the request, press the **CLR** Key, or highlight 'CANCEL' and press the **ENT** Key.
- 5) Push the **FMS** Knob to remove the flashing cursor, if required.

Deleting an entire procedure from the active flight plan:

- 1) Press the **FPL** Key to display the Active Flight Plan Page (MFD) or the Active Flight Plan Window (PFD).
- 2) Push the **FMS** Knob to activate the cursor (not required on the PFD) and turn the large **FMS** Knob to highlight the white header of the procedure to be deleted.

Or:

Use the Joystick to place the Quick Select Box on the white header of the procedure to be deleted (MFD only).

- 3) Press the **CLR** Key. The 'Remove <procedure name> from flight plan?' window is displayed.
- 4) With 'OK' highlighted, press the **ENT** Key. To cancel the request, press the **CLR** Key, or highlight 'CANCEL' and press the **ENT** Key.
- 5) Push the **FMS** Knob to remove the flashing cursor, if required.

Or:

- 1) Press the **FPL** Key to display the Active Flight Plan Page (MFD) or the Active Flight Plan Window (PFD).
- 2) Press the **MENU** Key to display the Page Menu and turn the **FMS** Knob to highlight 'Remove <procedure>'.
3) Press the **ENT** Key. The 'Remove <procedure name> from flight plan?' window is displayed.
- 4) With 'OK' highlighted, press the **ENT** Key. To cancel the request, press the **CLR** Key, or highlight 'CANCEL' and press the **ENT** Key.

Deleting an individual waypoint from a stored flight plan:

- 1) Press the **FPL** Key to display the Active Flight Plan Page.
- 2) Turn the small **FMS** Knob clockwise to display the Flight Plan Catalog Page.
- 3) Push the **FMS** Knob to activate the cursor and turn the **FMS** Knob to highlight the flight plan to be edited.
- 4) Press the **EDIT** Softkey; or press the **MENU** Key, select 'Edit Flight Plan' and press the **ENT** Key. The Stored Flight Plan Page is displayed.
- 5) Turn the large **FMS** Knob to highlight the waypoint to be deleted.
- 6) Press the **CLR** Key. The 'Remove XXXXX?' window is displayed.
- 7) With 'OK' highlighted, press the **ENT** Key. To cancel the request, press the **CLR** Key, or highlight 'CANCEL' and press the **ENT** Key.
- 8) Push the **FMS** Knob to remove the flashing cursor.

Deleting an entire airway from a stored flight plan:

- 1) Press the **FPL** Key to display the Active Flight Plan Page.
- 2) Turn the small **FMS** Knob clockwise to display the Flight Plan Catalog Page.
- 3) Push the **FMS** Knob to activate the cursor and turn the **FMS** Knob to highlight the flight plan to be edited.
- 4) Press the **EDIT** Softkey; or press the **MENU** Key, select 'Edit Flight Plan' and press the **ENT** Key. The Stored Flight Plan Page is displayed.
- 5) Turn the large **FMS** Knob to highlight the white header of the airway to be deleted.
- 6) Press the **CLR** Key. The 'Remove <airway name>?' window is displayed.
- 7) With 'OK' highlighted, press the **ENT** Key. To cancel the request, press the **CLR** Key, or highlight 'CANCEL' and press the **ENT** Key.
- 8) Push the **FMS** Knob to remove the flashing cursor.

Deleting an entire procedure from a stored flight plan:

- 1) Press the **FPL** Key to display the Active Flight Plan Page.
- 2) Turn the small **FMS** Knob clockwise to display the Flight Plan Catalog Page.
- 3) Push the **FMS** Knob to activate the cursor and turn the **FMS** Knob to highlight the flight plan to be edited.
- 4) Press the **EDIT** Softkey; or press the **MENU** Key, select 'Edit Flight Plan' and press the **ENT** Key. The Stored Flight Plan Page is displayed.
- 5) Turn the large **FMS** Knob to highlight the white header of the procedure to be deleted.

- 6) Press the **CLR** Key. The 'Remove <procedure name> from flight plan?' window is displayed.
 - 7) With 'OK' highlighted, press the **ENT** Key. To cancel the request, press the **CLR** Key, or highlight 'CANCEL' and press the **ENT** Key.
 - 8) Push the **FMS** Knob to remove the flashing cursor.
- Or:**
- 1) Press the **FPL** Key to display the Active Flight Plan Page.
 - 2) Turn the small **FMS** Knob clockwise to display the Flight Plan Catalog Page.
 - 3) Push the **FMS** Knob to activate the cursor and turn the **FMS** Knob to highlight the flight plan to be edited.
 - 4) Press the **EDIT** Softkey; or press the **MENU** Key, select 'Edit Flight Plan' and press the **ENT** Key. The Stored Flight Plan Page is displayed.
 - 5) Press the **MENU** Key to display the Page Menu and turn the **FMS** Knob to highlight 'Remove <procedure>'.
 - 6) Press the **ENT** Key. The 'Remove <procedure name> from flight plan?' window is displayed.
 - 7) With 'OK' highlighted, press the **ENT** Key. To cancel the request, press the **CLR** Key, or highlight 'CANCEL' and press the **ENT** Key.
 - 8) Push the **FMS** Knob to remove the flashing cursor.

CHANGING FLIGHT PLAN COMMENTS (NAMES)

The comment field (or name) of each flight plan can be changed to something that is useful for identification and sorting.

Changing the active flight plan comment:

- 1) Press the **FPL** Key to display the Active Flight Plan Page.
- 2) Push the **FMS** Knob to activate the cursor and turn the large **FMS** Knob to highlight the comment field.
- 3) Use the **FMS** Knobs to edit the comment.
- 4) Press the **ENT** Key to accept the changes.
- 5) Push the **FMS** Knob to remove the flashing cursor.

Or:

- 1) Press the **FPL** Key to display the Active Flight Plan Page.
- 2) Use the Joystick to place the Quick Select Box on the comment field.
- 3) Use the alphanumeric keys on the PFD/MFD Control Unit to edit the comment.
- 4) Press the **ENT** Key to accept the changes.

Changing a stored flight plan comment:

- 1) Press the **FPL** Key to display the Active Flight Plan Page.
- 2) Turn the small **FMS** Knob clockwise to display the Flight Plan Catalog Page.
- 3) Push the **FMS** Knob to activate the cursor and turn the **FMS** Knob to highlight the flight plan to be edited.

- 4) Press the **EDIT** Softkey; or press the **MENU** Key, select 'Edit Flight Plan' and press the **ENT** Key. The Stored Flight Plan Page is displayed.
- 5) Turn the large **FMS** Knob to highlight the comment field.
- 6) Use the **FMS** Knobs to edit the comment.
- 7) Press the **ENT** Key to accept the changes.
- 8) Push the **FMS** Knob to remove the flashing cursor.

ALONG TRACK OFFSETS

A waypoint having an “along track offset” distance from an existing waypoint can be entered into a flight plan. Along track offset waypoints lie along the path of the existing flight plan, and can be used to make the system reach a specified altitude before or after reaching the specified flight plan waypoint. Offset distances can be entered from 1 to 999 nm in increments of 1 nm. Entering a negative offset distance results in an along track offset waypoint inserted before the selected waypoint, whereas entering a positive offset distance results in an along track offset waypoint inserted after the selected waypoint. Multiple offset waypoints are allowed.

A waypoint must be adjacent to its parent waypoint in the flight plan, so the system limits the along-track distance to less than the length of the leg before or after the selected waypoint. If the selected waypoint is the active waypoint, the distance is limited to less than the distance to go to the active waypoint. Assigning an along track offset to a leg with indeterminate length is not permitted. An along track offset is not allowed at or after the final approach fix of an approach.

An along track offset distance cannot be modified once entered. If the along track offset distance must be changed, the existing along track offset waypoint must be deleted and a new one created with the new offset distance.

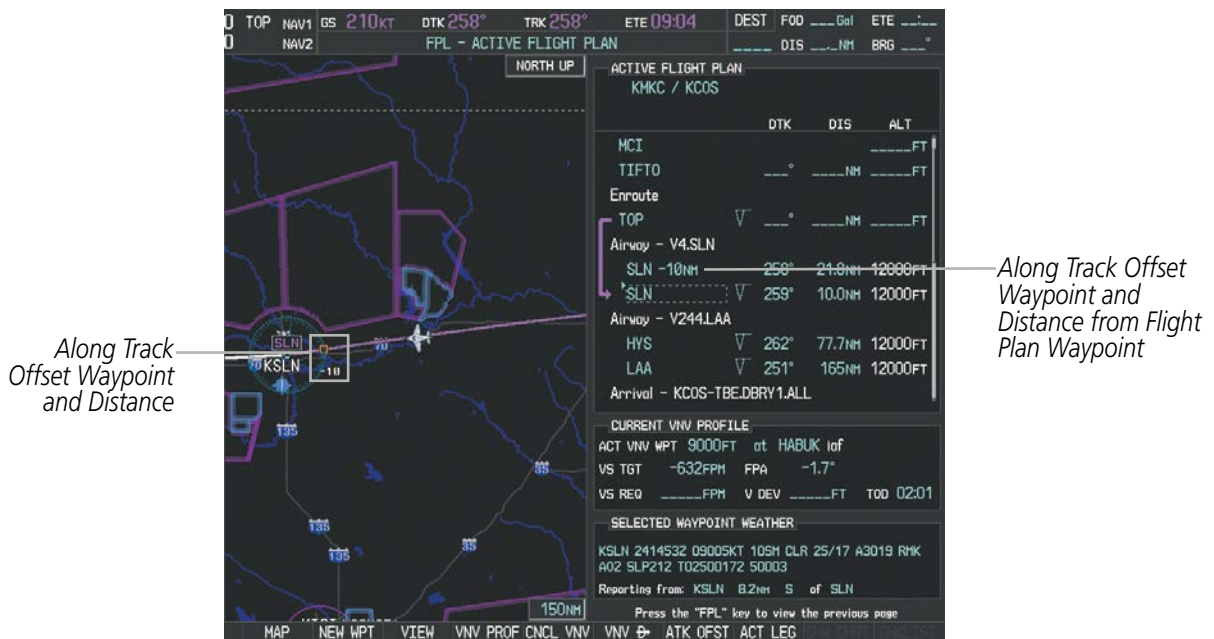

Figure 5-86 Along Track Offset

Entering an along track offset distance:

- 1) Press the **FPL** Key to display the Active Flight Plan Page (MFD) or the Active Flight Plan Window (PFD).
- 2) Push the **FMS** Knob to activate the cursor (not required on the PFD) and turn the large **FMS** Knob to highlight the waypoint for the along track offset.
- 3) Press the **ATK OFST** Softkey (MFD only); or press the **MENU** Key, highlight 'Create ATK Offset Waypoint', and press the **ENT** Key.
- 4) Enter a positive or negative offset distance in the range of +/- 1 to 999 nm (limited by leg distances).
- 5) Press the **ENT** Key to create the offset waypoint.
- 6) Push the **FMS** Knob to remove the flashing cursor.

PARALLEL TRACK

The Parallel Track (PTK) feature allows creation of a parallel course offset of 1 to 50 nm left or right of the current flight plan. When Parallel Track is activated, the course line drawn on the map pages shows the parallel course, and waypoint names have a lower case "p" placed after the identifier.

Using direct-to, loading an approach, a holding pattern, or editing and activating the flight plan automatically cancels Parallel Track. Parallel Track is also cancelled if a course change occurs greater than 120° or the parallel tracks overlap as a result of the course change.



NOTE: Vertical navigation is unavailable while the Parallel Track feature is active.

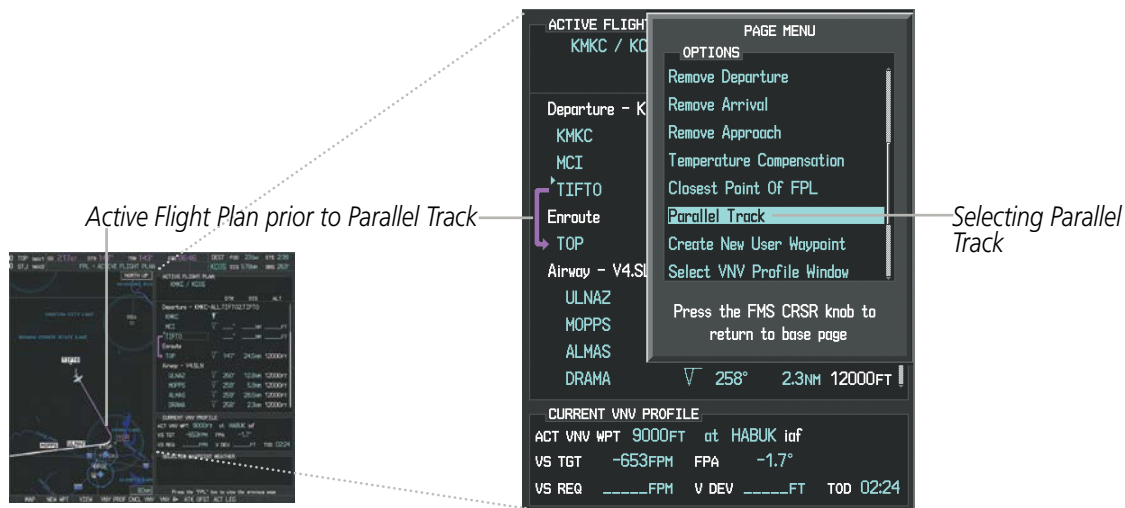

Figure 5-87 Active Flight Plan Window - Selecting Parallel Track

Activating parallel track:

- 1) Press the **FPL** Key to display the Active Flight Plan Page (MFD) or the Active Flight Plan Window (PFD).
- 2) Press the **MENU** Key, highlight 'Parallel Track', and press the **ENT** Key. The Parallel Track Window is displayed with the direction field highlighted.
- 3) Turn the small **FMS** Knob to select 'Left' or 'Right' and press the **ENT** Key. The 'DISTANCE' field is highlighted.

- 4) Turn the small **FMS** Knob to enter a distance from 1-99 nm and press the **ENT** Key. 'ACTIVATE PARALLEL TRACK' is highlighted.
- 5) Press the **ENT** Key to activate parallel track. Push the **FMS** Knob or the **CLR** Key to cancel the parallel track activation.

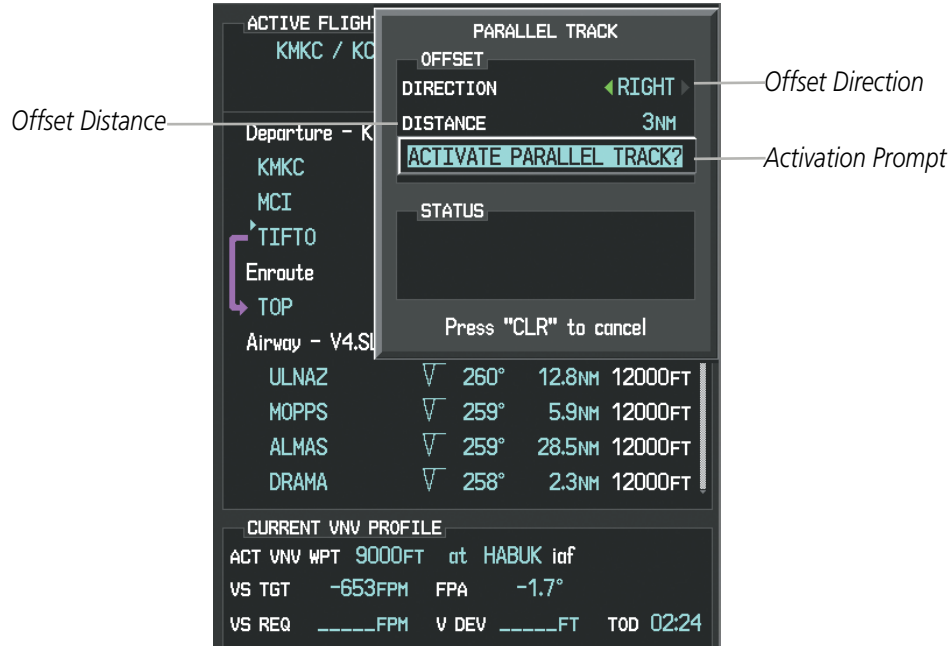

Figure 5-88 Parallel Track Window



Figure 5-89 Parallel Track Active

If the parallel track proposed by the offset direction and distance is not allowed by the system, the activation prompt is displayed, but disabled. Parallel Track cannot be activated if a course is set using direct-to or if the active leg is the first leg of the departure procedure. Attempting to activate parallel track with these conditions results in the message 'Parallel Track Unavailable Invalid Route Geometry'. If an approach leg is active the status indicates that the system is unable to activate the parallel track with the message 'Parallel Track Unavailable Approach Leg Active'. If the offset direction and distance results in an unreasonable route geometry the status indicates that the system is unable to activate the parallel track because of invalid geometry.

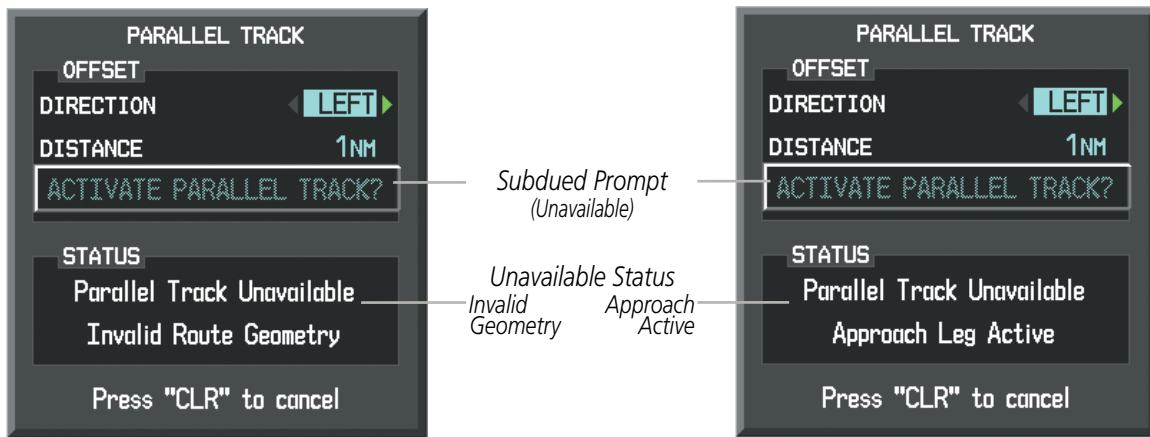

Figure 5-90 Parallel Track Unavailable

If the active leg is not a track between two fixes (TF) or a course to a fix (DF) leg, the status indicates that the system is unable to activate the parallel track because parallel track is not available for the active leg type.

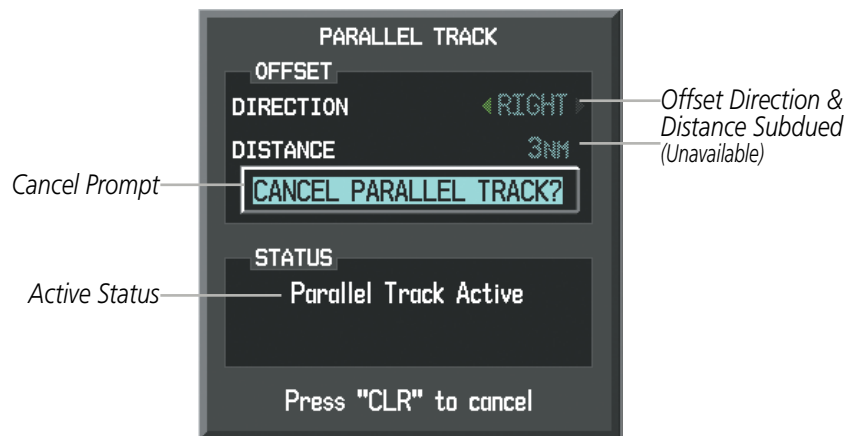

Figure 5-91 Cancelling Parallel Track

Cancelling parallel track:

- 1) Press the **FPL** Key to display the Active Flight Plan Page (MFD) or the Active Flight Plan Window (PFD).
- 2) Press the **MENU** Key, highlight 'Parallel Track', and press the **ENT** Key. The Parallel Track Window is displayed with 'CANCEL PARALLEL TRACK?' highlighted.
- 3) Press the **ENT** Key.

ACTIVATING A FLIGHT PLAN LEG

Perspective allows selection of a highlighted leg as the “active leg” (the flight plan leg which is currently used for navigation guidance).

Activating a flight plan leg:

- 1) Press the **FPL** Key to display the Active Flight Plan Page (MFD) or the Active Flight Plan Window (PFD).
 - 2) Push the **FMS** Knob to activate the cursor (not required on the PFD) and turn the large **FMS** Knob to highlight the destination waypoint for the desired leg.
- Or:**
- Use the Joystick to place the Quick Select Box on the destination waypoint for the desired leg.
- 3) Press the **ACT LEG** Softkey (MFD only); or press the **MENU** Key, highlight ‘Activate Leg’, and press the **ENT** Key. A confirmation window is displayed with ‘ACTIVATE’ highlighted.
 - 4) Press the **ENT** Key to activate the flight plan leg. To cancel, press the **CLR** Key, or highlight ‘CANCEL’ and press the **ENT** Key.
 - 5) Push the **FMS** Knob to remove the flashing cursor, if required.



Figure 5-92 Active Flight Plan Page - Selecting the Leg Destination Waypoint



Figure 5-93 Active Flight Plan Page - New Active Leg

INVERTING A FLIGHT PLAN

Any flight plan may be inverted (reversed) for navigation back to the original departure point.

Inverting the active flight plan:

- 1) Press the **FPL** Key to display the Active Flight Plan Page (MFD) or the Active Flight Plan Window (PFD).
- 2) Press the **MENU** Key, highlight 'Invert Flight Plan', and press the **ENT** Key. An 'Invert Active Flight Plan?' confirmation window is displayed.
- 3) Select 'OK'.
- 4) Press the **ENT** Key to invert and activate the active flight plan. To cancel, press the **CLR** Key, or highlight 'CANCEL' and press the **ENT** Key.

Inverting and activating a stored flight plan:

- 1) Press the **FPL** Key and turn the small **FMS** Knob to display the Flight Plan Catalog Page.
- 2) Push the **FMS** Knob to activate the cursor, and turn the **FMS** Knob to highlight the desired flight plan.
- 3) Press the **INVERT** Softkey; or press the **MENU** Key, highlight 'Invert & Activate FPL?', and press the **ENT** Key. The 'Invert and activate stored flight plan?' window is displayed.
- 4) With 'OK' highlighted, press the **ENT** Key. To cancel the request, press the **CLR** Key, or highlight 'CANCEL' and press the **ENT** Key.

FLIGHT PLAN VIEWS

Information about flight plans can be viewed in more than one way. The active flight plan can be configured to show cumulative distance over the length of the flight plan or the distance for each leg of the flight plan; and the active flight plan can be viewed in a narrow or wide view. In the wide view, additional information is displayed: Fuel Remaining (FUEL REM), Estimated Time Enroute (ETE), Estimated Time of Arrival (ETA), and Bearing to the waypoint (BRG).

Switching between leg-to-leg waypoint distance and cumulative waypoint distance:

- 1) Press the **FPL** Key on the MFD to display the Active Flight Plan Page.
- 2) Press the **VIEW** Softkey to display the **CUM** and **LEG-LEG** Softkeys.
- 3) Press the **CUM** Softkey to view cumulative waypoint distance, or press the **LEG-LEG** Softkey to view leg-to-leg waypoint distance.
- 4) Press the **BACK** Softkey to return to the top level active flight plan softkeys.

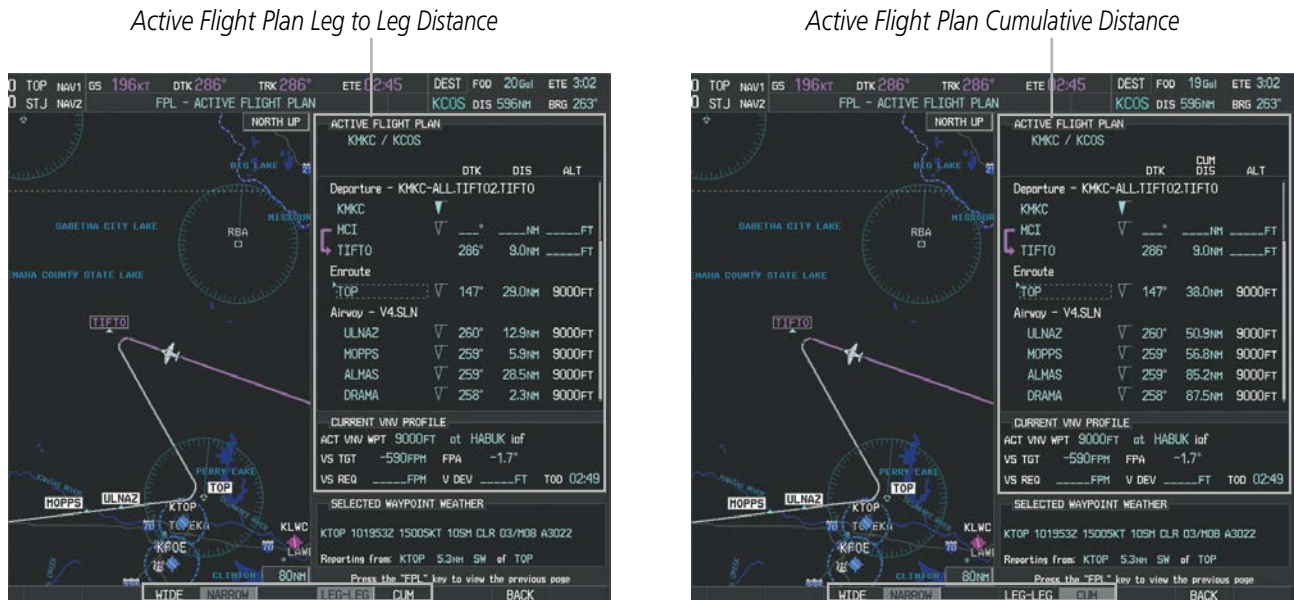

WIDE Softkey, **NARROW** Softkey, **LEG-LEG** Softkey, **CUM** Softkey

Figure 5-94 Active Flight Plan - Leg to Leg vs. Cumulative Distance

Switching between wide and narrow view:

- 1) Press the **FPL** Key on the MFD to display the Active Flight Plan Page.
- 2) Press the **VIEW** Softkey to display the **WIDE** and **NARROW** Softkeys.
- 3) Press the **WIDE** Softkey to display the wide view, or press the **NARROW** Softkey to display the narrow view.
- 4) Press the **BACK** Softkey to return to the top level active flight plan softkeys.

SYSTEM OVERVIEW
 FLIGHT INSTRUMENTS
 EIS
 AUDIO PANEL & CNS
 FLIGHT MANAGEMENT
 HAZARD AVOIDANCE
 AFCS
 ADDITIONAL FEATURES
 APPENDICES
 INDEX

Active Flight Plan Narrow View



Active Flight Plan Wide View



WIDE Softkey, NARROW Softkey, LEG-LEG Softkey, CUM Softkey

Figure 5-95 Active Flight Plan - Wide vs. Narrow View

COLLAPSING AIRWAYS

Perspective allows airways on the active flight plan to be collapsed or expanded from the Active Flight Plan Page/Window. When airways have been collapsed, it is indicated on the airway heading.

When airways are collapsed, leg-to-leg computed values such as DIS or ETE shown for the exit waypoint reflect the total of all the legs on the airway that have been hidden in the collapsed display. The DTK value is inhibited because it is not usable in this context.

The Active Flight Plan Page always keeps the following three waypoints visible: “From” waypoint, “To” waypoint, and “Next” waypoint. To prevent one or more of these waypoints from being hidden in a collapsed airway segment, the airway segment that contains either the “To” or the “Next” waypoint is automatically expanded. When an airway is loaded, airways are automatically expanded to facilitate flight plan review.

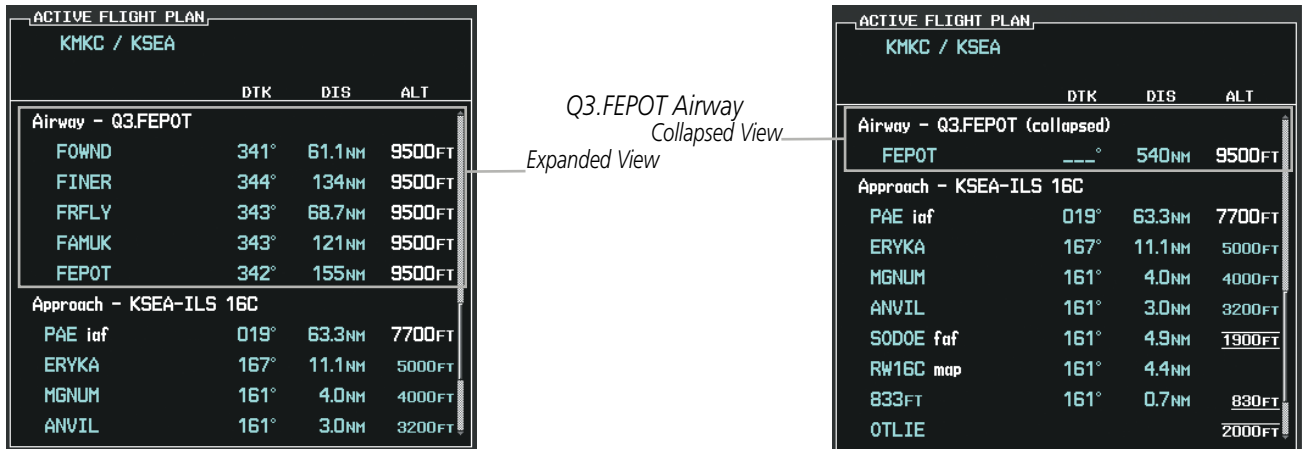

Figure 5-96 Expanded/Collapsed Airways

Collapsing/expanding the airways in the active flight plan:

- 1) Press the **FPL** Key to display the Active Flight Plan Page (MFD) or the Active Flight Plan Window (PFD).
- 2) Press the **MENU** Key, highlight 'Collapse Airways' or 'Expand Airways', and press the **ENT** Key. The airways are collapsed/expanded.

CLOSEST POINT OF FPL

'Closest Point of FPL' calculates the bearing and closest distance at which a flight plan passes a reference waypoint, and creates a new user waypoint along the flight plan at the location closest to a chosen reference waypoint.

Determining the closest point along the active flight plan to a selected waypoint:

- 1) Press the **FPL** Key to display the Active Flight Plan Page (MFD) or the Active Flight Plan Window (PFD).
- 2) Press the **MENU** Key, highlight 'Closest Point Of FPL', and press the **ENT** Key. A window appears with the reference waypoint field highlighted.
- 3) Enter the identifier of the reference waypoint and press the **ENT** Key. The system displays the bearing (BRG) and distance (DIS) to the closest point along the flight plan to the selected reference waypoint and creates a user waypoint at this location. The name for the new user waypoint is derived from the identifier of the reference waypoint.

SYSTEM OVERVIEW

FLIGHT INSTRUMENTS

EIS

AUDIO PANEL & CNS

FLIGHT MANAGEMENT

HAZARD AVOIDANCE

AFCS

ADDITIONAL FEATURES

APPENDICES

INDEX

USER-DEFINED HOLDING PATTERNS

A holding pattern can be defined at any active flight plan waypoint, at the aircraft present position, or at a direct-to waypoint.

Creating a user-defined hold at an active flight plan waypoint:

- 1) Press the **FPL** Key to display the Active Flight Plan Page (MFD) or the Active Flight Plan Window (PFD).
- 2) Push the **FMS** Knob to activate the cursor (not required on the PFD) and turn the large **FMS** Knob to highlight the waypoint for the hold.
- 3) Press the **MENU** Key, highlight 'Hold At Waypoint', and press the **ENT** Key. The HOLD AT window appears with the course field highlighted.
- 4) Use the **FMS** Knobs to edit the entry course, and press the **ENT** Key.
- 5) Use the small **FMS** Knob to select 'INBOUND' or 'OUTBOUND' course direction, and press the **ENT** Key.
- 6) Use the small **FMS** Knob to select 'TIME' or 'DIST' length mode, and press the **ENT** Key.
- 7) Use the **FMS** Knobs to edit the length, and press the **ENT** Key.
- 8) Use the small **FMS** Knob to select 'RIGHT' or 'LEFT' turn direction, and press the **ENT** Key.
- 9) Use the **FMS** Knobs to edit the Expect Further Clearance Time (EFC TIME), and press the **ENT** Key.
- 10) Press the **ENT** Key while 'LOAD?' is highlighted to insert the hold into the flight plan.

ACTIVE FLIGHT PLAN
KMKC / KCOS

	DTK	DIS	ALT
Departure - KMKC-ALL.TIFT02.TIFT0			
KMKC			
MCI	323°	11.8NM	_____FT
TIFT0	287°	54.8NM	_____FT
Enroute			
TOP	147°	28.7NM	_____FT
Airway - V4.SLN			
ULNAZ	260°	12.8NM	_____FT
MOPPS	259°	5.9NM	_____FT
ALMAS	259°	28.5NM	_____FT
DRAMA	258°	2.3NM	_____FT

Waypoint Selected

ACTIVE FLIGHT PLAN
KMKC / KCOS

PAGE MENU

OPTIONS

- Parallel Track
- Create New User Waypoint
- Select VNV Profile Window
- Cancel VNV
- VNV ⇌
- Create ATK Offset Waypoint
- Hold At Waypoint**
- Hold At Present Position

Press the FMS CRSR knob to return to base page

Hold At Waypoint Menu Selection

HOLD AT
DIRECTION, COURSE

HOLD EAST OF TIFT0 *Location of Hold*

COURSE 286° INBOUND *Course Direction (INBOUND or OUTBOUND)*

Hold Entry Course

LEG TIME, DISTANCE

LEG TIME 1:00 *Leg Length (Time in nm or Distance in minutes)*

Leg Length Mode Button (TIME or DIST)

TURNS

TURN DIRECTION RIGHT *Turn Direction (RIGHT or LEFT)*

MAP

GOFF WETMORE

TIFT0

8NM

Map of Hold Location

EXPECT FURTHER CLEARANCE

EFC TIME __: __ UTC *Expect Further Clearance Time*

LOAD? *Load Hold in Active Flight Plan*

Figure 5-97 Creating a User Defined Holding Pattern at an Active Flight Plan Waypoint

Creating a user-defined hold at the aircraft present position:

- 1) Press the **FPL** Key to display the Active Flight Plan Page (MFD) or the Active Flight Plan Window (PFD).
- 2) Press the **MENU** Key, highlight 'Hold At Present Position', and press the **ENT** Key. The HOLD AT window appears with the course field highlighted.
- 3) If desired, use the **FMS** Knobs to edit the entry course, and press the **ENT** Key.
- 4) Use the small **FMS** Knob to select 'INBOUND' or 'OUTBOUND' course direction, and press the **ENT** Key.
- 5) Use the small **FMS** Knob to select 'TIME' or 'DIST' length mode, and press the **ENT** Key.
- 6) Use the **FMS** Knobs to edit the length, and press the **ENT** Key.
- 7) Use the small **FMS** Knob to select 'RIGHT' or 'LEFT' turn direction, and press the **ENT** Key.
- 8) Use the **FMS** Knobs to edit the Expect Further Clearance Time (EFC TIME), and press the **ENT** Key.
- 9) Press the **ENT** Key while 'ACTIVATE?' is highlighted to create an Offroute Direct-to hold waypoint at the aircraft present position and activate the hold.

Creating a user-defined hold at a direct-to waypoint:

- 1) Press a **→** Key and set up the direct-to waypoint as desired, but select 'HOLD?' instead of 'ACTIVATE?' when finished (MFD or PFD).
- 2) Use the **FMS** Knobs to edit the entry course, and press the **ENT** Key.
- 3) Use the small **FMS** Knob to select 'INBOUND' or 'OUTBOUND' course direction, and press the **ENT** Key.
- 4) Use the small **FMS** Knob to select 'TIME' or 'DIST' length mode, and press the **ENT** Key.
- 5) Use the **FMS** Knobs to edit the length, and press the **ENT** Key.
- 6) Use the small **FMS** Knob to select 'RIGHT' or 'LEFT' turn direction, and press the **ENT** Key.
- 7) Use the **FMS** Knobs to edit the Expect Further Clearance Time (EFC TIME), and press the **ENT** Key.
- 8) Press the **ENT** Key while 'ACTIVATE?' is highlighted to activate the direct-to with the user-defined hold defined at the direct-to waypoint. (If the direct-to waypoint is part of the active flight plan, the HOLD is inserted into the active flight plan. If the direct-to waypoint is not part of the active flight plan, an off-route direct-to hold is created.)

Exiting a user-defined hold inserted into the active flight plan:

Press the **SUSP** Softkey. The system will provide guidance to follow the holding pattern to the inbound course and resume automatic waypoint sequencing.

Removing a user-defined hold inserted into the active flight plan:

- 1) Press the **FPL** Key to display the Active Flight Plan Page (MFD) or the Active Flight Plan Window (PFD).
- 2) Push the **FMS** Knob to activate the cursor (not required on the PFD) and turn the large **FMS** Knob to highlight the HOLD waypoint.
- 3) Press the **CLR** Key. A 'Remove Holding Pattern?' confirmation window is displayed.
- 4) Select 'OK' and press the **ENT** Key. The holding pattern is removed from the active flight plan. Select 'CANCEL' and press the **ENT** Key to cancel the removal of the holding pattern.

Editing a user-defined hold:

- 1) Press the **FPL** Key to display the Active Flight Plan Page (MFD) or the Active Flight Plan Window (PFD).
- 2) Push the **FMS** Knob to activate the cursor (not required on the PFD) and turn the large **FMS** Knob to highlight the waypoint for the hold.
- 3) Press the **MENU** Key, highlight 'Edit Hold', and press the **ENT** Key. The HOLD AT window appears with the course field highlighted.
- 4) Use the **FMS** Knobs to edit the entry course, and press the **ENT** Key.
- 5) Use the small **FMS** Knob to select 'INBOUND' or 'OUTBOUND' course direction, and press the **ENT** Key.
- 6) Use the small **FMS** Knob to select 'TIME' or 'DIST' length mode, and press the **ENT** Key.
- 7) Use the **FMS** Knobs to edit the length, and press the **ENT** Key.
- 8) Use the small **FMS** Knob to select 'RIGHT' or 'LEFT' turn direction, and press the **ENT** Key.
- 9) Use the **FMS** Knobs to edit the Expect Further Clearance Time (EFC TIME), and press the **ENT** Key.
- 10) Press the **ENT** Key while 'UPDATE?' is highlighted to update the hold.

Removing a user-defined hold at an off-route direct-to:

- 1) Press a **→** Key to display the DIRECT TO Window (PFD or MFD).
- 2) Press the **MENU** Key to display the PAGE MENU with the cursor on the 'Cancel Direct-To NAV' selection.
- 3) Press the **ENT** Key. The holding pattern is removed.

- SYSTEM OVERVIEW
- FLIGHT INSTRUMENTS
- EIS
- AUDIO PANEL & CNS
- FLIGHT MANAGEMENT
- HAZARD AVOIDANCE
- AFCS
- ADDITIONAL FEATURES
- APPENDICES
- INDEX

ACTIVE FLIGHT PLAN
KMKC / KCOS

	DTK	DIS	ALT
Departure - KMKC-ALL.TIFT02.TIFT0			
KMKC			
MCI	323°	11.8NM	_____FT
TIFT0	287°	54.8NM	_____FT
Enroute			
TOP	147°	28.7NM	_____FT
Airway - V4.SLN			
ULNAZ	260°	12.8NM	_____FT
MOPPS	259°	5.9NM	_____FT
ALMAS	259°	28.5NM	_____FT
DRAMA	258°	2.3NM	_____FT

ACTIVE FLIGHT PLAN
KMKC / KCOS

PAGE MENU
OPTIONS

- Parallel Track
- Create New User Waypoint
- Select VNV Profile Window
- Cancel VNV
- VNV ⇄
- Create ATK Offset Waypoint
- Hold At Waypoint
- Hold At Present Position**

Press the FMS CRSR knob to return to base page

Hold At Present Position Menu Selection

HOLD AT
DIRECTION, COURSE

HOLD SOUTHEAST OF P.POS *Location of Hold*

COURSE 323° INBOUND *Course Direction (INBOUND or OUTBOUND)*

Hold Entry Course

LEG TIME, DISTANCE

LEG TIME 1:00 *Leg Length (Time in nm or Distance in minutes)*

Leg Length Mode Button (TIME or DIST)

TURN DIRECTION RIGHT *Turn Direction (RIGHT or LEFT)*

MAP

Map of Hold Location

EXPECT FURTHER CLEARANCE

EFC TIME ___:___UTC *Expect Further Clearance Time*

ACTIVATE? *Activate Hold*

Figure 5-98 Creating a User Defined Holding Pattern at the Aircraft Present Position

ACTIVE FLIGHT PLAN
KMKC / KCOS

	DTK	DIS	ALT
Departure - KMKC-ALL.TIFTO2.TIFTO			
KMKC			
MCI	323°	11.8NM	_____FT
TIFTO	287°	54.8NM	_____FT
Enroute			
TOP	147°	28.7NM	_____FT
Airway - V4.SLN			
ULNAZ	260°	12.8NM	_____FT
MOPPS	259°	5.9NM	_____FT
ALMAS	259°	28.5NM	_____FT
DRAMA	258°	2.3NM	_____FT

Waypoint Selected

DIRECT TO
IDENT, FACILITY, CITY
TIFTO ▲ N CEN USA

VNV
_____FT +0NM

MAP
NORTH UP
US 2m
CN 2m
TIFTO
15NM

LOCATION
BRG 292° DIS 64.4NM

COURSE
290°

ACTIVATE?

HOLD?

Hold At Direct To Waypoint Selection

HOLD AT
DIRECTION, COURSE
HOLD EAST OF TIFTO

COURSE 290° ◀ INBOUND ▶

LEG TIME, DISTANCE
LEG ◀ TIME ▶ 1:00

URNS
TURN DIRECTION ◀ RIGHT ▶

MAP
NORTH UP
US 7m
CN 7m
GOFF
9
WETMORE
TIFTO
8NM

EXPECT FURTHER CLEARANCE
EFC TIME ___:___UTC

ACTIVATE?

Hold Entry Course
Location of Hold
Course Direction (INBOUND or OUTBOUND)
Leg Length (Time in nm or Distance in minutes)
Turn Direction (RIGHT or LEFT)
Leg Length Mode Button (TIME or DIST)
Map of Hold Location
Expect Further Clearance Time
Load Hold and Activate Direct To

Figure 5-99 Creating a User Defined Holding Pattern at a Direct To Waypoint

5.7 VERTICAL NAVIGATION

NOTE: The system supports vertical path guidance and altitude constraints for the following leg types: AF, CD, CF, CI, CR, DF, FC, FD, PI, RF, and TF. Altitude constraints are not retained in stored flight plans.

The Perspective Vertical Navigation (VNV) feature provides vertical profile guidance during the enroute and terminal phases of flight. Guidance based on specified altitudes at waypoints in the active flight plan or to a direct-to waypoint is provided. It includes vertical path guidance to a descending path, which is provided as a linear deviation from the desired path. The desired path is defined by a line joining two waypoints with specified altitudes or as a vertical angle from a specified waypoint/altitude. The vertical waypoints are integrated into the active flight plan. Both manual and autopilot-coupled guidance are supported.

Current Vertical Navigation Profile Disabled (fields dashed)

Current Vertical Navigation Profile Enabled (valid data)



ENBL VNV Softkey



CNCL VNV Softkey

Figure 5-100 Enabling/Disabling Vertical Navigation

Enabling VNV guidance:

- 1) Press the **FPL** Key to display the Active Flight Plan Page on the MFD.
- 2) Press the **ENBL VNV** Softkey; or press the **MENU** Key, highlight 'Enable VNV', and press the **ENT** Key. Vertical navigation is enabled, and vertical guidance begins with the waypoint shown in the CURRENT VNV PROFILE box (defaults first waypoint in the active flight plan with an altitude enabled for vertical navigation (e.g., HABUK)).

Disabling VNV guidance:

- 1) Press the **FPL** Key to display the Active Flight Plan Page on the MFD.
- 2) Press the **CNCL VNV** Softkey; or press the **MENU** Key, highlight 'Cancel VNV', and press the **ENT** Key. Vertical navigation is disabled.

Canceling vertical navigation results in vertical deviation (V DEV), vertical speed required (VS REQ), and time to top of descent/bottom of descent (TIME TO TOD/BOD) going invalid. The Vertical Deviation Indicator (VDI) and Required Vertical Speed Indicator (RVS) on the PFD are removed, and the V DEV, VS REQ, and TIME TO TOD items displayed in the CURRENT VNV PROFILE box are dashed. VNV remains disabled until manually enabled. Vertical guidance in reversionary mode can only be enabled for a direct-to waypoint.

Perspective allows a vertical navigation direct-to to any waypoint in the active flight plan with an altitude constraint "designated" for vertical guidance. Pressing the **VNV** \rightarrow Softkey on the Active Flight Plan Page allows the flight plan to be flown, while vertical guidance based on the altitude constraint at the VNV direct-to waypoint is provided. The altitude change begins immediately and is spread along the flight plan from current position to the vertical direct-to waypoint, not just along the leg for the direct-to waypoint. A direct-to with altitude constraint activated by pressing the \rightarrow Key also provides vertical guidance, but would bypass flight plan waypoints between the current position in the flight plan and the direct-to waypoint. A top of descent (TOD) point is computed based on the default flight path angle; descent begins once the TOD is reached.

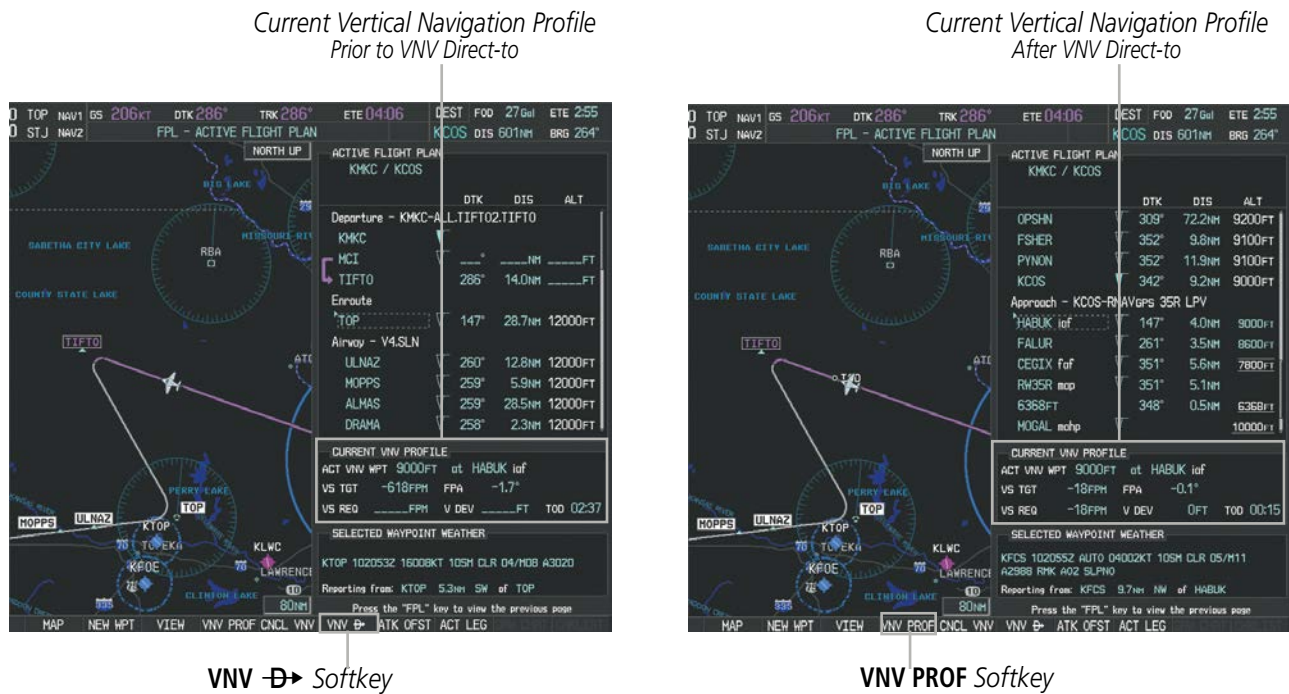

Figure 5-101 Vertical Navigation Direct-To

Activating a vertical navigation direct-to:

- 1) Press the **FPL** Key to display the Active Flight Plan Page on the MFD.
- 2) Push the **FMS** Knob to activate the cursor and turn the **FMS** Knob to highlight the desired waypoint.

Or:

Use the Joystick to place the Quick Select Box on the desired waypoint.



NOTE: The selected waypoint must have a designated altitude constraint (cyan number) to be used. If not, the first waypoint in the flight plan with a designated altitude constraint is selected.

- 3) Press the **VNV**  Softkey; or press the **MENU** Key, highlight 'VNV Direct-To', and press the **ENT** Key. An 'Activate vertical Direct-to to: NNNNNFT at XXXXXX?' confirmation window is displayed.
- 4) Press the **ENT** Key. Vertical guidance begins to the altitude constraint for the selected waypoint.
- 5) Push the **FMS** Knob to remove the flashing cursor.

The vertical navigation profile can be modified by directly entering a vertical speed target (VS TGT) and/or flight path angle (FPA) in the CURRENT VNV PROFILE box.

Modifying the VS TGT and FPA using the FMS Knob:

- 1) Press the **FPL** Key to display the Active Flight Plan Page on the MFD.
- 2) Press the **VNV PROF** Softkey; or press the **MENU** Key, highlight 'Select VNV Profile Window', and press the **ENT** Key. The cursor is now located in the CURRENT VNV PROFILE box.
- 3) Turn the **FMS** Knobs as needed to edit the values.
- 4) Push the **FMS** Knob to remove the flashing cursor.

Modifying the VS TGT and FPA using the Quick Select Box:

- 1) Press the **FPL** Key to display the Active Flight Plan Page on the MFD.
- 2) Use the Joystick to place the Quick Select Box on VS TGT or FPA.
- 3) Enter the values using the alphanumeric keys on the PFD/MFD Control Unit and press the **ENT** Key.

ALTITUDE CONSTRAINTS

Perspective can use altitude constraints associated with lateral waypoints to give guidance for vertical navigation. These altitudes are, depending on the specific instance, manually entered or retrieved from the published altitudes in the navigation database. The navigation database only contains altitudes for procedures that call for "Cross at" altitudes. If the procedure states "Expect to cross at," then the altitude is not in the database. In this case the altitude may be entered manually.

SYSTEM OVERVIEW

FLIGHT INSTRUMENTS

EIS

AUDIO PANEL & CNS

FLIGHT MANAGEMENT

HAZARD AVOIDANCE

AFCS

ADDITIONAL FEATURES

APPENDICES

INDEX

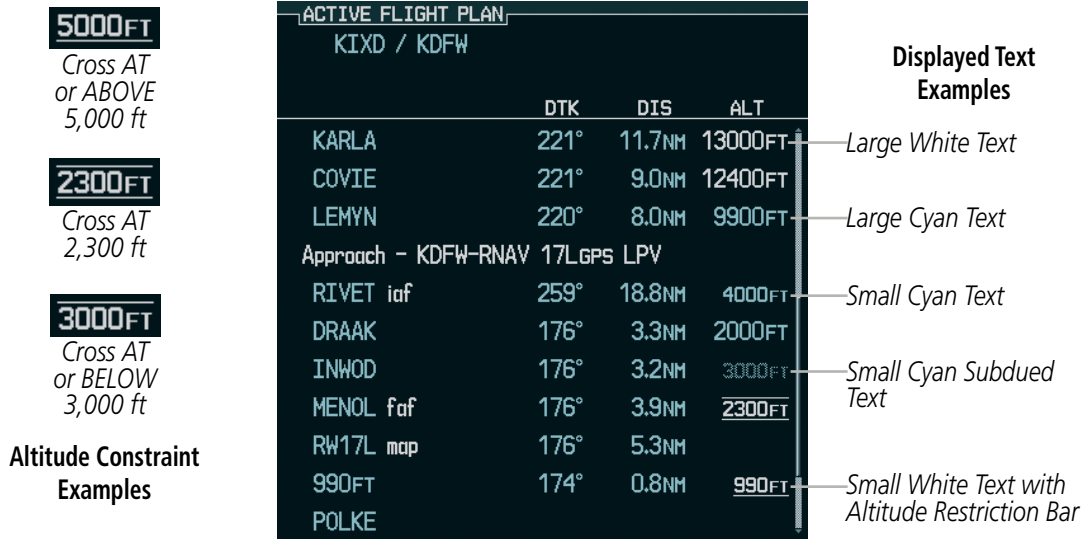

Figure 5-102 Waypoint Altitude Constraints

	White Text	Cyan Text	Cyan Subdued Text
Large Text	Altitude calculated by the system estimating the altitude of the aircraft as it passes over the navigation point. This altitude is provided as a reference and is not designated to be used in determining vertical speed and deviation guidance.	Altitude has been entered manually. Altitude is designated for use in giving vertical speed and deviation guidance. Altitude does not match the published altitude in navigation database or no published altitude exists.	The system cannot use this altitude in determining vertical speed and deviation guidance because of an invalid constraint condition.
Small Text	Altitude is not designated to be used in determining vertical speed and deviation guidance. Altitude has been retrieved from the navigation database and is provided as a reference.	Altitude is designated for use in giving vertical speed and deviation guidance. Altitude has been retrieved from the navigation database or has been entered manually and matches a published altitude in the navigation database.	The system cannot use this altitude in determining vertical speed and deviation guidance because of an invalid constraint condition.

Table 5-8 Altitude Constraint Size and Color Coding

Altitudes associated with approach procedures are “auto-designated”. This means the system automatically uses the altitudes loaded with the approach for giving vertical speed and deviation guidance. Note that these altitudes are displayed as cyan text up to, but not including, the FAF. The FAF is always a “reference only” altitude and cannot be designated, unless the selected approach does not provide vertical guidance. In this case, the FAF altitude can be designated.

Altitudes that have been designated for use in vertical guidance can be “un-designated” using the **CLR** Key. The altitude is now displayed only as a reference. It is not used to give vertical guidance. Other displayed altitudes may change due to re-calculations or be rendered invalid as a result of manually changing an altitude to a non-designated altitude.

Designating a waypoint altitude to be used for vertical guidance using the FMS Knob:

- 1) Press the **FPL** Key to display the Active Flight Plan Page on the MFD.
- 2) Push the **FMS** Knob, and turn to highlight the desired waypoint altitude.
- 3) Turn the small **FMS** Knob to enter editing mode.
- 4) Press the **ENT** Key. The altitude is now shown in cyan, indicating it is usable for vertical guidance.

Designating a waypoint altitude to be used for vertical guidance using the Quick Select Box:

- 1) Press the **FPL** Key to display the Active Flight Plan Page on the MFD.
- 2) Use the Joystick to place the Quick Select Box on the desired waypoint altitude.
- 3) Use the alphanumeric keys on the PFD/MFD Control Unit to enter the same altitude.
- 4) Press the **ENT** Key. The altitude is now shown in cyan, indicating it is usable for vertical guidance.

Designating a procedure waypoint altitude to be used for vertical guidance:

- 1) Press the **FPL** Key to display the Active Flight Plan Page on the MFD.
- 2) Push the **FMS** Knob, and turn to highlight the desired waypoint altitude.

Or:

Use the Joystick to place the Quick Select Box on the desired waypoint altitude (MFD only).

- 3) Press the **ENT** Key. The altitude is now shown in cyan, indicating it is usable for vertical guidance.

Altitude constraints are displayed and entered in feet mean sea level (MSL) values to the nearest hundred. An altitude constraint in feet above ground level (AGL) format is supported for airports. When a database altitude restriction is displayed, the system allows entry of a different altitude when creating a waypoint, effectively overriding the database restriction (only before the FAF). When a database altitude restriction of type “AT or ABOVE” or “AT or BELOW” is activated, the system uses the “AT” portion of the restriction to define the vertical profile.

An altitude constraint is invalid if:

- Meeting the constraint requires the aircraft to climb
- Meeting the constraint requires the maximum flight path angle or maximum vertical speed to be exceeded
- The altitude constraint results in a TOD behind the aircraft present position
- The constraint is within a leg type for which altitude constraints are not supported
- The altitude constraint is added to the FAF of an approach that provides vertical guidance (i.e., ILS or GPS SBAS approach)
- The altitude constraint is added to a waypoint past the FAF.

Entering/modifying an altitude constraint using the FMS Knob:

- 1) Press the **FPL** Key to display the Active Flight Plan Page on the MFD.
- 2) Push the **FMS** Knob, and turn to highlight the desired waypoint altitude constraint.
- 3) Enter an altitude constraint value using the **FMS** Knobs. To enter altitudes as a flight level, turn the small **FMS** Knob counter-clockwise past zero or clockwise past 9 on the first character, and the system automatically changes to show units of Flight Level. Turn the large **FMS** Knob clockwise to highlight the first zero and enter the three digit flight level.
- 4) Press the **ENT** Key to accept the altitude constraint; if the selected waypoint is an airport, an additional choice is displayed. Turn the small **FMS** Knob to choose 'MSL' or 'AGL', and press the **ENT** Key to accept the altitude.

Entering/modifying an altitude constraint using the Quick Select Box:

- 1) Press the **FPL** Key to display the Active Flight Plan Page on the MFD.
- 2) Use the Joystick to place the Quick Select Box on the desired waypoint altitude constraint.
- 3) Enter an altitude constraint value using the **alphanumeric keys on the PFD/MFD Control Unit**. To enter altitudes as a flight level, enter F as the first character.
- 4) Press the **ENT** Key to accept the altitude constraint; if the selected waypoint is an airport, an additional choice is displayed. Turn the small **FMS** Knob to choose 'MSL' or 'AGL', and press the **ENT** Key to accept the altitude.

Altitude constraints can be modified or deleted after having been added to the flight plan. In the event an altitude constraint is deleted and the navigation database contains an altitude restriction for the lateral waypoint, the system displays the altitude restriction from the database provided no predicted altitude can be provided. The system also provides a way to reinstate a published altitude constraint that has been edited.

Deleting an altitude constraint provided by the navigation database:

- 1) Press the **FPL** Key to display the Active Flight Plan Page on the MFD.
- 2) Push the **FMS** Knob, and turn to highlight the desired waypoint altitude constraint.
Or:
Use the Joystick to place the Quick Select Box on the desired waypoint altitude constraint (MFD only).
- 3) Press the **CLR** Key. A 'Remove VNV altitude constraint?' confirmation window is displayed.
- 4) Select 'OK' and press the **ENT** Key.

Deleting an altitude constraint that has been manually entered:

- 1) Press the **FPL** Key to display the Active Flight Plan Page on the MFD.
- 2) Push the **FMS** Knob, and turn to highlight the desired waypoint altitude constraint.
Or:
Use the Joystick to place the Quick Select Box on the desired waypoint altitude constraint (MFD only).
- 3) Press the **CLR** Key. A 'Remove or Revert to published VNV altitude of nnnnnFT?' confirmation window is displayed.
- 4) Select 'REMOVE' and press the **ENT** Key. The manually entered altitude is deleted (it is replaced by a system calculated altitude, if available).

Reverting a manually entered altitude constraint back to the navigation database value:

- 1) Press the **FPL** Key to display the Active Flight Plan Page on the MFD.
- 2) Push the **FMS** Knob, and turn to highlight the desired waypoint altitude constraint.

Or:

Use the Joystick to place the Quick Select Box on the desired waypoint altitude constraint (MFD only).

- 3) Press the **CLR** Key. A 'Remove or Revert to published VNV altitude of nnnnnFT?' confirmation window is displayed.
- 4) Select 'REVERT' and press the **ENT** Key. The altitude is changed to the navigation database value.
- 5) Push the **FMS** Knob to remove the flashing cursor.

Modifying a system calculated altitude constraint:

- 1) Press the **FPL** Key to display the Active Flight Plan Page on the MFD.
- 2) Push the **FMS** Knob, and turn to highlight the desired waypoint altitude constraint.

Or:

Use the Joystick to place the Quick Select Box on the desired waypoint altitude constraint (MFD only).

- 3) Press the **CLR** Key. An 'Edit or Revert to published VNV altitude of nnnnnFT?' confirmation window is displayed.
- 4) Select 'EDIT' and press the **ENT** Key.
- 5) Edit the value using the **FMS** Knobs, and press the **ENT** Key.
- 6) Push the **FMS** Knob to remove the flashing cursor.

5.8 PROCEDURES

Perspective can access the whole range of instrument procedures available. Departures (DPs), arrivals (STARs), and non-precision and precision approaches (APPRs) are stored within the database and can be loaded using the Procedures (**PROC**) Key.

The selected procedure for the departure or arrival airport is added to the active flight plan. No waypoints are required to be in the active flight plan to load procedures; however, if the departure and arrival airport are already loaded, the procedure loading window defaults to the appropriate airport, saving some time selecting the correct airport on the Procedure Loading Page. Whenever an approach is selected, the choice to either “load” or “activate” is given. “Loading” adds the approach to the end of the flight plan without immediately using it for navigation guidance. This allows continued navigation via the intermediate waypoints in the original flight plan, but keeps the procedure available on the Active Flight Plan Page for quick activation when needed. “Activating” also adds the procedure to the end of the flight plan but immediately begins to provide guidance to the first waypoint in the approach.

The system adds terminal procedures to the flight plan based on leg types coded within that procedure in the navigation database. If the terminal procedure in the flight plan contains an identifier like ‘6368FT’, that indicates a leg that terminates when the specified altitude (6368 feet) has been exceeded. A heading leg in the flight plan displays ‘hdg’ preceding the DTK (e.g. ‘hdg 008°’). A flight plan leg requiring the pilot to manually initiate sequencing to the next leg displays ‘MANSEQ’ as the identifier.



Figure 5-103 Procedure Leg Identifiers

DEPARTURES

A Departure Procedure (DP) is loaded at the departure airport in the flight plan. Only one departure can be loaded at a time in a flight plan. If a departure is loaded when another departure is already in the active flight plan, the new departure replaces the previous departure. The route is defined by selection of a departure, the transition waypoints, and a runway.

LOADING A DEPARTURE INTO THE ACTIVE FLIGHT PLAN

Loading a departure into the active flight plan using the **PROC** Key:

- 1) Press the **PROC** Key. The Procedures Window is displayed.
- 2) Highlight 'SELECT DEPARTURE'.
- 3) Press the **ENT** Key. The Departure Loading Page is displayed.
- 4) Use the **FMS** Knob to select an airport and press the **ENT** Key.
- 5) Select a departure from the list and press the **ENT** Key.
- 6) Select a runway (if required) and press the **ENT** Key.
- 7) Select a transition (if required) and press the **ENT** Key. 'LOAD?' is highlighted.
- 8) Press the **ENT** Key to load the departure procedure.

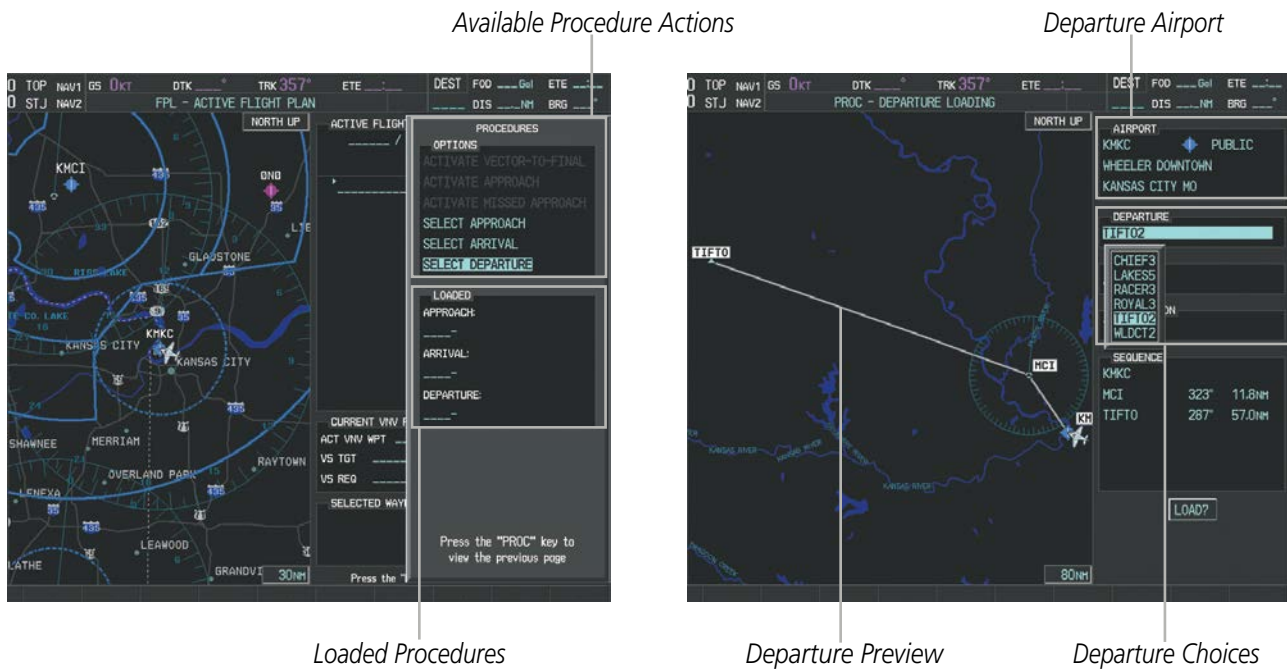

Figure 5-104 Departure Selection



Procedure Loading Page Selection Softkeys

Figure 5-105 Departure Loading

Viewing available departures at an airport:

- 1) From the Airport Information Page (first page in the WPT group), press the **DP** Softkey. The Departure Information Page is displayed, defaulting to the airport displayed on the Airport information Page.
- 2) To select another airport, push the **FMS** Knob to activate the cursor, enter an identifier/facility name/city, and press the **ENT** Key.
- 3) Turn the large **FMS** Knob to highlight the Departure. The departure is previewed on the map.
- 4) Turn the small **FMS** Knob to view the available departures. Press the **ENT** Key to select the departure. The cursor moves to the Runway box. The departure is previewed on the map.
- 5) Turn the small **FMS** Knob to view the available runways. Press the **ENT** Key to select the runway. The cursor moves to the Transition box (only if there are available transitions). The departure is previewed on the map.
- 6) Turn the small **FMS** Knob to view the available transitions. Press the **ENT** Key to select the transition. The cursor moves to the Sequence box. The departure is previewed on the map.
- 7) Press the **INFO-1** Softkey or the **INFO-2** Softkey to return to the Airport Information Page.

Loading a departure into the active flight plan from the Departure Information Page:

- 1) From the Airport Information Page (first page in the WPT group), press the **DP** Softkey. The Departure Information Page is displayed, defaulting to the airport displayed on the Airport information Page.
- 2) To select another airport, push the **FMS** Knob to activate the cursor, enter an identifier/facility name/city, and press the **ENT** Key.

- 3) Select a different departure, if desired.
 - a) Turn the large **FMS** Knob to highlight the Departure. The departure is previewed on the map.
 - b) Turn the small **FMS** Knob to view the available departures. Press the **ENT** Key to select the departure. The cursor moves to the Runway box. The departure is previewed on the map.
 - c) Turn the small **FMS** Knob to view the available runways. Press the **ENT** Key to select the runway. The cursor moves to the Transition box (only if there are available transitions). The departure is previewed on the map.
 - d) Turn the small **FMS** Knob to view the available transitions. Press the **ENT** Key to select the transition. The cursor moves to the Sequence box. The departure is previewed on the map.
- 4) Press the MENU Key to display the Departure Information Page Menu.
- 5) Turn the **FMS** Knob to highlight 'Load Departure'.
- 6) Press the ENT Key to load the departure procedure into the active flight plan.

REMOVING A DEPARTURE FROM THE ACTIVE FLIGHT PLAN

When plans change while flying IFR, departures can be easily removed from the Active Flight Plan.

Removing a departure procedure from the active flight plan:

- 1) Press the **FPL** Key to display the Active Flight Plan Page (MFD) or the Active Flight Plan Window (PFD).
- 2) Press the **MENU** Key, and highlight 'Remove Departure'.
- 3) Press the **ENT** Key. A confirmation window is displayed listing the departure procedure.
- 4) With 'OK' highlighted, press the **ENT** Key. To cancel the removal request, highlight 'CANCEL' and press the **ENT** Key.

Or:

 - 1) Press the **FPL** Key to display the Active Flight Plan Page (MFD) or the Active Flight Plan Window (PFD).
 - 2) Push the **FMS** Knob, and turn to highlight the departure header in the active flight plan.

Or:

 Use the Joystick to place the Quick Select Box on the departure header.
- 3) Press the **CLR** Key. A confirmation window is displayed listing the departure procedure.
- 4) With 'OK' highlighted, press the **ENT** Key. To cancel the removal request, highlight 'CANCEL' and press the **ENT** Key.
- 5) Push the **FMS** Knob to remove the flashing cursor.

ARRIVALS

A Standard Terminal Arrival (STAR) can be loaded at any airport that has one available. Only one arrival can be loaded at a time in a flight plan. If an arrival is loaded when another arrival is already in the active flight plan, the new arrival replaces the previous arrival. The route is defined by selection of an arrival, the transition waypoints, and a runway.

LOADING AN ARRIVAL INTO THE ACTIVE FLIGHT PLAN

Loading an arrival into the active flight plan using the **PROC** Key:

- 1) Press the **PROC** Key. The Procedures Window is displayed.
- 2) Highlight 'SELECT ARRIVAL'.
- 3) Press the **ENT** Key. The Arrival Loading Page is displayed.
- 4) Use the **FMS** Knob to select an airport and press the **ENT** Key.
- 5) Select an arrival from the list and press the **ENT** Key.
- 6) Select a transition (if required) and press the **ENT** Key.
- 7) Select a runway (if required) and press the **ENT** Key. 'LOAD?' is highlighted.
- 8) Press the **ENT** Key to load the arrival procedure.

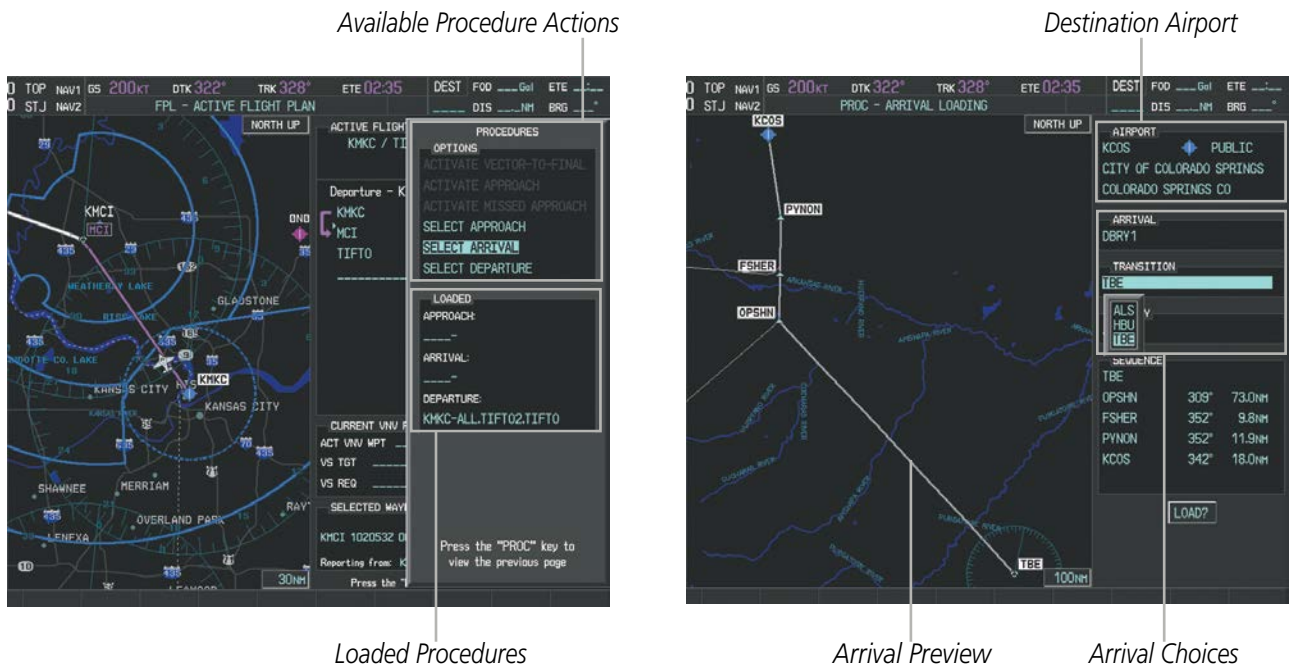
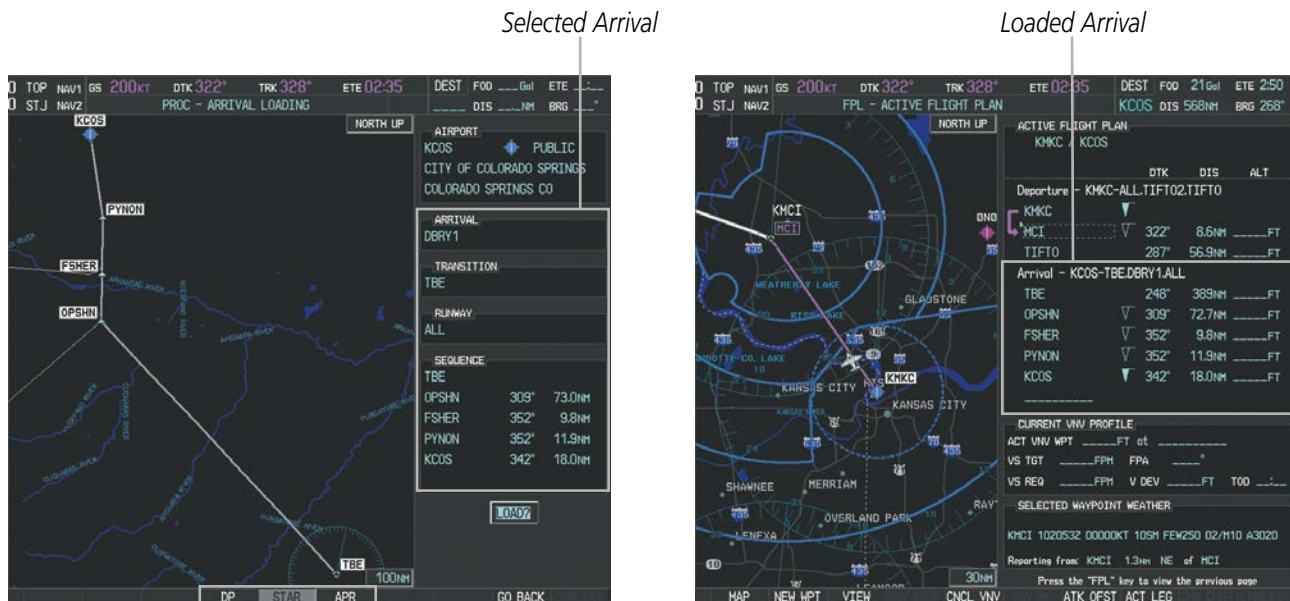

Figure 5-106 Arrival Selection

SYSTEM OVERVIEW
 FLIGHT INSTRUMENTS
 EIS
 AUDIO PANEL & CNS
 FLIGHT MANAGEMENT
 HAZARD AVOIDANCE
 AFCS
 ADDITIONAL FEATURES
 APPENDICES
 INDEX



Procedure Loading Page Selection Softkeys

Figure 5-107 Arrival Loading

Viewing available arrivals at an airport:

- 1) From the Airport Information Page (first page in the WPT group), press the **STAR** Softkey. The Arrival Information Page is displayed, defaulting to the airport displayed on the Airport Information Page.
- 2) To select another airport, push the **FMS** Knob to activate the cursor, enter an identifier/facility name/city, and press the **ENT** Key.
- 3) Turn the large **FMS** Knob to highlight the Arrival. The arrival is previewed on the map.
- 4) Turn the small **FMS** Knob to view the available arrivals. Press the **ENT** Key to select the arrival. The cursor moves to the Transition box. The arrival is previewed on the map.
- 5) Turn the small **FMS** Knob to view the available transitions. Press the **ENT** Key to select the transition. The cursor moves to the Runway box. The arrival is previewed on the map.
- 6) Turn the small **FMS** Knob to view the available runways. Press the **ENT** Key to select the runway. The cursor moves to the Sequence box. The arrival is previewed on the map.
- 7) Press the **INFO-1** Softkey or the **INFO-2** Softkey to return to the Airport Information Page.

Loading an arrival into the active flight plan from the Arrival Information Page:

- 1) From the Airport Information Page (first page in the WPT group), press the **STAR** Softkey. The Arrival Information Page is displayed, defaulting to the airport displayed on the Airport information Page.
- 2) To select another airport, push the **FMS** Knob to activate the cursor, enter an identifier/facility name/city, and press the **ENT** Key.
- 3) Select a different arrival, if desired.
 - a) Turn the large **FMS** Knob to highlight the arrival. The arrival is previewed on the map.
 - b) Turn the small **FMS** Knob to view the available arrivals. Press the **ENT** Key to select the arrival. The cursor moves to the Transition box (only if there are available transitions). The arrival is previewed on the map.

- c) Turn the small **FMS** Knob to view the available transitions. Press the **ENT** Key to select the transition. The cursor moves to the Runway box. The arrival is previewed on the map.
- d) Turn the small **FMS** Knob to view the available runways. Press the **ENT** Key to select the runway. The cursor moves to the Sequence box. The arrival is previewed on the map.
- 4) Press the **MENU** Key to display the Arrival Information Page Menu.
- 5) Turn the **FMS** Knob to highlight 'Load Arrival'.
- 6) Press the **ENT** Key to load the arrival procedure into the active flight plan.

REMOVING AN ARRIVAL FROM THE ACTIVE FLIGHT PLAN

When plans change while flying IFR, arrivals can be easily removed from the Active Flight Plan.

Removing an arrival from the active flight plan:

- 1) Press the **FPL** Key to display the Active Flight Plan Page (MFD) or the Active Flight Plan Window (PFD).
 - 2) Press the **MENU** Key, and highlight 'Remove Arrival'.
 - 3) Press the **ENT** Key. A confirmation window is displayed listing the arrival procedure.
 - 4) With 'OK' highlighted, press the **ENT** Key. To cancel the removal request, highlight 'CANCEL' and press the **ENT** Key.
- Or:**
- 1) Press the **FPL** Key to display the Active Flight Plan Page (MFD) or the Active Flight Plan Window (PFD).
 - 2) Push the **FMS** Knob, and turn to highlight the arrival header in the active flight plan.
- Or:**
- Use the Joystick to place the Quick Select Box on the arrival header.
- 3) Press the **CLR** Key. A confirmation window is displayed listing the arrival procedure.
 - 4) With 'OK' highlighted, press the **ENT** Key. To cancel the removal request, highlight 'CANCEL' and press the **ENT** Key.
 - 5) Push the **FMS** Knob to remove the flashing cursor.

APPROACHES



NOTE: If certain GPS parameters (SBAS, RAIM, etc.) are not available, some published approach procedures for the desired airport may not be displayed in the list of available approaches.

An Approach Procedure (APPR) can be loaded at any airport that has one available, and provides guidance for non-precision and precision approaches to airports with published instrument approach procedures. If an approach is loaded when another approach is already in the flight plan, the new approach replaces the previous approach, unless the active leg is past the missed approach point. In this case, the second approach is loaded at the end of the previous approach, and the previous approach is converted to waypoints (no longer part of an APPR). The approach sequence is defined by selection of an approach and the transition waypoints.

Whenever an approach is selected, the choice to either “Load” or “Load & Activate” is given (“Load & Activate” is only available for the active flight plan). “Loading” adds the approach to the end of the flight plan without immediately using it for navigation guidance. This allows continued navigation via the intermediate waypoints in the original flight plan, but keeps the procedure available for quick activation when needed. “Activating” also adds the procedure to the end of the flight plan but immediately begins to provide guidance to the first waypoint in the approach.

When selecting an approach, a “GPS” designation to the right of the approach type indicates the procedure can be flown using the GPS receiver. Some procedures do not have this designation, meaning the GPS receiver can be used for supplemental navigation guidance only. If the GPS receiver cannot be used for primary guidance, the appropriate navigation receiver must be used for the selected approach (e.g., VOR or ILS). The final course segment of ILS approaches, for example, must be flown by tuning the NAV receiver to the proper frequency and selecting that NAV receiver on the CDI.

Perspective SBAS GPS allows for flying LNAV, LNAV+V, LNAV/VNAV, LP, LP+V, and LPV approach service levels according to the published chart. The ‘+V’ designation adds advisory vertical guidance for assistance in maintaining a constant vertical glidepath similar to an ILS glideslope on approach. This guidance is displayed on the system PFD in the same location as the ILS glideslope using a magenta diamond. Baro VNAV guidance is displayed on the system PFD in the same location as the ILS glideslope using a magenta pentagon. The active approach service level is annunciated on the HSI as shown in the following table:

HSI Annunciation	Description	Example on HSI
LNAV	RNAV GPS approach using published LNAV minima	 <p>Approach Service Level - LNAV, LNAV+V, L/VNAV, LP, LP+V, LPV</p>
LNAV+V	RNAV GPS approach using published LNAV minima. Advisory vertical guidance is provided	
L/VNAV (available only if SBAS available)	RNAV GPS approach using published LNAV/VNAV minima (downgrades to Baro VNAV if SBAS unavailable)	
LP (available only if SBAS available)	RNAV GPS approach using published LP minima (downgrades to LNAV if SBAS unavailable)	
LP+V (available only if SBAS available)	RNAV GPS approach using published LP minima Advisory vertical guidance is provided	
LPV (available only if SBAS available)	RNAV GPS approach using published LPV minima (downgrades to Baro VNAV if SBAS unavailable)	

Table 5-9 Approach Types

LOADING AN APPROACH INTO THE ACTIVE FLIGHT PLAN

Loading an approach into the active flight plan using the PROC Key:

- 1) Press the **PROC** Key. The Procedures Window is displayed.
- 2) Highlight 'SELECT APPROACH', and press the **ENT** Key. The Approach Loading Page is displayed.
- 3) Select the airport and approach:
 - a) Use the **FMS** Knob to select an airport and press the **ENT** Key.
 - b) Select an approach from the list and press the **ENT** Key.

Or:

 - a) If necessary, push the **FMS** Knob to exit the approach list, and use the large **FMS** Knob to move the cursor to the APPROACH CHANNEL field.
 - b) Use the **FMS** Knob to enter the approach channel number, and press the **ENT** Key to accept the approach channel number. The airport and approach are selected.
- 4) Select a transition (if required) and press the **ENT** Key.
- 5) Minimums
 - a) To set 'MINIMUMS', turn the small **FMS** Knob to select 'BARO' or 'TEMP COMP', and press the **ENT** Key. Turn the small **FMS** Knob to select the altitude, and press the **ENT** Key.
 - b) If 'TEMP COMP' was selected, the cursor moves to the temperature field. Turn the small **FMS** Knob to select the temperature, and press the **ENT** Key.

Or:

To skip setting minimums, press the **ENT** Key.
- 6) Press the **ENT** Key with 'LOAD?' highlighted to load the approach procedure; or turn the large **FMS** Knob to highlight 'ACTIVATE' and press the **ENT** Key to load and activate the approach procedure.



NOTE: When GPS is not approved for the selected final approach course, the message 'NOT APPROVED FOR GPS' is displayed. GPS provides guidance to the approach, but the HSI must be switched to a NAV receiver to fly the final course of the approach.

- SYSTEM OVERVIEW
- FLIGHT INSTRUMENTS
- EIS
- AUDIO PANEL & CNS
- FLIGHT MANAGEMENT
- HAZARD AVOIDANCE
- AFCS
- ADDITIONAL FEATURES
- APPENDICES
- INDEX

Figure 5-108 Approach Selection

Procedure Loading Page Selection Softkeys LOAD or ACTIVATE? Annunciation

Figure 5-109 Approach Loading

Viewing available approaches at an airport:

- 1) From the Airport Information Page (first page in the WPT group), press the **APR** Softkey. The Approach Information Page is displayed, defaulting to the airport displayed on the Airport information Page.
- 2) To select another airport, push the **FMS** Knob to activate the cursor, enter an identifier/facility name/city, and press the **ENT** Key.
- 3) Push the **FMS** Knob, then turn the large **FMS** Knob to highlight the Approach. The approach is previewed on the map.
- 4) Turn the small **FMS** Knob to view the available approaches. Press the **ENT** Key to select the approach. The cursor moves to the Transition box. The approach is previewed on the map.
- 5) Turn the small **FMS** Knob to view the available transitions. Press the **ENT** Key to select the transition. The cursor moves to the Minimums box. The approach is previewed on the map.
- 6) Press the **INFO-1** Softkey or the **INFO-2** Softkey to return to the Airport Information Page.

Loading an approach into the active flight plan from the Nearest Airport Page:

- 1) Select the Nearest Airports Page.
- 2) Push the **FMS** Knob, then turn the large **FMS** Knob to highlight the desired nearest airport. The airport is previewed on the map.
- 3) Press the **APR** Softkey; or press the **MENU** Key, highlight 'Select Approach Window', and press the **ENT** Key.
- 4) Turn the **FMS** Knob to highlight the desired approach.
- 5) Press the **LD APR** Softkey; or press the **MENU** Key, highlight 'Load Approach', and press the **ENT** Key. The Approach Loading Page is displayed with the transitions field highlighted.
- 6) Turn the **FMS** Knob to highlight the desired transition, and press the **ENT** Key.
- 7) Minimums
 - a) To set 'MINIMUMS', turn the small **FMS** Knob to select 'BARO' or 'TEMP COMP', and press the **ENT** Key. Turn the small **FMS** Knob to select the altitude, and press the **ENT** Key.
 - b) If 'TEMP COMP' was selected, the cursor moves to the temperature field. Turn the small **FMS** Knob to select the temperature, and press the **ENT** Key.

Or:

To skip setting minimums, press the **ENT** Key. The 'LOAD?' field is highlighted.
- 8) Press the **ENT** Key with 'LOAD?' highlighted to load the approach procedure; or turn the large **FMS** Knob to highlight 'ACTIVATE' and press the **ENT** Key to load and activate the approach procedure. The system continues navigating the current flight plan until the approach is activated. When GPS is not approved for the selected final approach course, the message 'NOT APPROVED FOR GPS' is displayed. GPS provides guidance to the approach, but the HSI must be switched to a NAV receiver to fly the final course of the approach.

ACTIVATING AN APPROACH

A previously loaded approach can be activated from the Procedures Window.

Activating a previously loaded approach:

- 1) Press the **PROC** Key. The Procedures Window is displayed with 'Activate Approach' highlighted.
- 2) Press the **ENT** Key to activate the approach.

In many cases, it may be easiest to “load” the full approach while still some distance away, enroute to the destination airport. Later, if vectored to final, use the steps above to select 'Activate Vector-To-Final' — which makes the inbound course to the FAF waypoint active.

Activating a previously loaded approach with vectors to final:

- 1) Press the **PROC** Key to display the Procedures Window.
- 2) Highlight 'ACTIVATE VECTOR-TO-FINAL' and press the **ENT** Key.

Loading and activating an approach using the MENU Key:

- 1) From the Approach Loading Page, press the **MENU** Key. The page menu is displayed with 'Load & Activate Approach' highlighted.
- 2) Press the **ENT** Key. When GPS is not approved for the selected final approach course, the message 'NOT APPROVED FOR GPS' is displayed. GPS provides guidance to the approach, but the HSI must to be switched to a NAV receiver to fly the final course of the approach.

REMOVING AN APPROACH FROM THE ACTIVE FLIGHT PLAN

When plans change while flying IFR, approaches can be easily removed from the Active Flight Plan.

Removing an approach from the active flight plan:

- 1) Press the **FPL** Key to display the Active Flight Plan Page (MFD) or the Active Flight Plan Window (PFD).
- 2) Press the **MENU** Key, and highlight 'Remove Approach'.
- 3) Press the **ENT** Key. A confirmation window is displayed listing the approach procedure.
- 4) With 'OK' highlighted, press the **ENT** Key. To cancel the removal, highlight 'CANCEL' and press the **ENT** Key.

Or:

- 1) Press the **FPL** Key to display the Active Flight Plan Page (MFD) or the Active Flight Plan Window (PFD).
- 2) Push the **FMS** Knob, and turn to highlight the approach header in the active flight plan.

Or:

Use the Joystick to place the Quick Select Box on the approach header.

- 3) Press the **CLR** Key. A confirmation window is displayed listing the approach procedure.
- 4) With 'OK' highlighted, press the **ENT** Key. To cancel the removal, highlight 'CANCEL' and press the **ENT** Key.
- 5) Push the **FMS** Knob to remove the flashing cursor.

MISSED APPROACH

Activating a missed approach in the active flight plan:

- 1) Press the **PROC** Key.
- 2) Turn the **FMS** Knob to highlight 'ACTIVATE MISSED APPROACH'.
- 3) Press the **ENT** Key. The aircraft automatically sequences to the MAHP.

Or:

Press the Go-Around Button.

In this missed approach procedure, the altitude immediately following the MAP (in this case '6368FT') is not part of the published procedure. It is simply a Course to Altitude (CA) leg which guides the aircraft along the runway centerline until the altitude required to safely make the first turn toward the MAHP is exceeded. This altitude is provided by the navigation database, and may be below, equal to, or above the published minimums for this approach. In this case, if the aircraft altitude is below the specified altitude (6,368 feet) after crossing the MAP, a direct-to is established to provide a course on runway heading until an altitude of 6,368 feet is reached. After reaching 6,368 feet, a direct-to is established to the published MAHP (in this case MOGAL). If the aircraft altitude is above the specified altitude after crossing the MAP, a direct-to is established to the published fix (MOGAL) to begin the missed approach procedure.

ACTIVE FLIGHT PLAN			
KMCI / KCOS			
	DTK	DIS	ALT
FSHER	352°	9.8NM	12000FT
PYNON	352°	11.9NM	9900FT
Approach - KCOS-RNAV 35R GPS LPV			
HABUK iaf	021°	5.9NM	9000FT
FALUR	261°	5.0NM	8600FT
CEGIX faf	351°	6.0NM	7800FT
RW35R map	351°	5.1NM	
			6368FT
MOGAL mahp			10000FT
HOLD	168°	6.0NM	

Figure 5-110 Course to Altitude

In some missed approach procedures this Course to Altitude leg may be part of the published procedure. For example, a procedure may dictate a climb to 5,500 feet, then turn left and proceed to the Missed Approach Hold Point (MAHP). In this case, the altitude would appear in the list of waypoints as '5500FT'. Again, if the aircraft altitude is lower than the prescribed altitude, a direct-to is established on a Course to Altitude leg when the missed approach procedure is activated.

TEMPERATURE COMPENSATED ALTITUDE

If desired, the system can compensate the loaded approach altitudes based on a pilot-supplied temperature at the destination. For example, if the pilot enters a destination temperature of -40° C, the system increases the approach altitudes accordingly. A temperature compensated altitude is displayed in slanted text.

Activating temperature compensated altitude:

- 1) From the Active Flight Plan Page, press the **MENU** Key. The Page Menu is displayed.
- 2) Turn the **FMS** Knob to highlight 'Temperature Compensation'.
- 3) Press the **ENT** Key. The TEMPERATURE COMPENSATION Window is displayed.
- 4) Use the small **FMS** Knob to select the temperature at the <airport>. The compensated altitude is computed as the temperature is selected.



NOTE: The temperature at the destination can be entered in the TEMPERATURE COMPENSATION Window on the MFD, or in the REFERENCES Window on the PFD. There is only one compensation temperature for the system, therefore, changing the temperature will affect both the loaded approach altitudes and the minimums. Refer to the Flight Instruments section for information about applying temperature compensation to the MDA/DH.

- 5) Press the **ENT** Key. 'ACTIVATE COMPENSATION?' is highlighted.
- 6) Press the **ENT** Key. The compensated altitudes for the approach are shown in the flight plan.

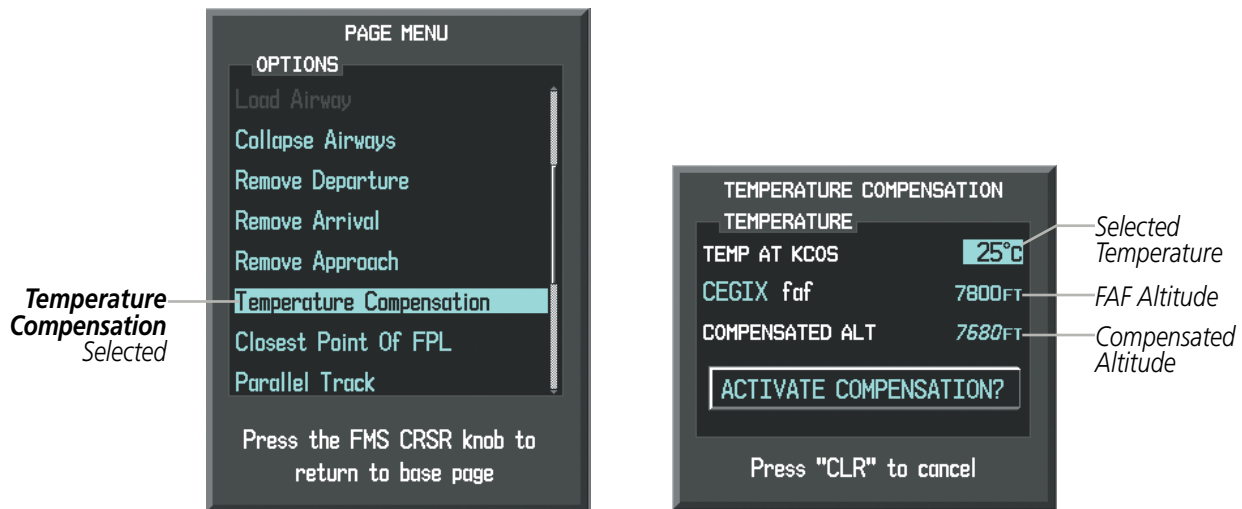

Figure 5-111 Temperature Compensation

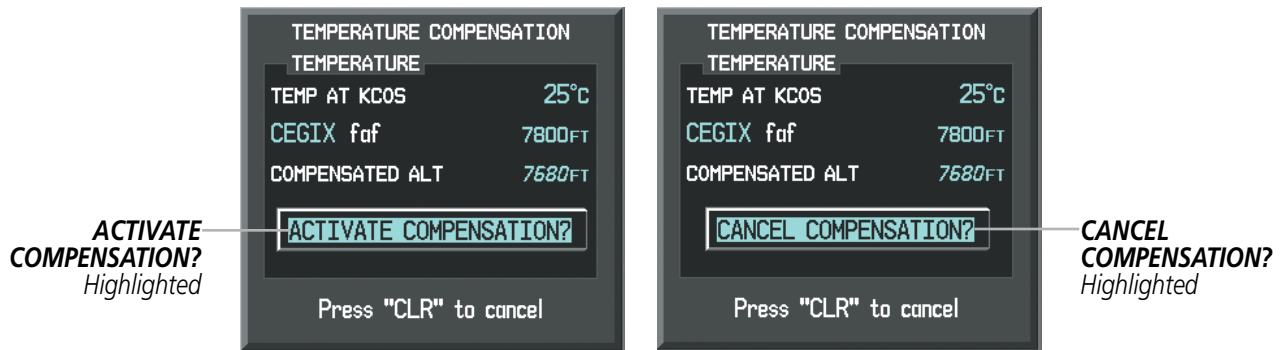

Figure 5-112 Activating/Cancelling Temperature Compensation



Figure 5-113 Temperature Compensation in the Active Flight Plan

Cancelling temperature compensated altitude:

- 1) From the Active Flight Plan Page, press the **MENU** Key. The Page Menu is displayed.
- 2) Turn the **FMS** Knob to highlight 'Temperature Compensation'.
- 3) Press the **ENT** Key. The TEMPERATURE COMPENSATION Window is displayed.
- 4) Press the **ENT** Key. 'CANCEL COMPENSATION?' is highlighted.
- 5) Press the **ENT** Key. The temperature compensated altitude at the FAF is cancelled.



NOTE: Activating/cancelling temperature compensation for the loaded approach altitudes does not select/deselect temperature compensated minimums (MDA/DH), nor does selecting/deselecting temperature compensated minimums activate/cancel temperature compensated approach altitudes.

5.9 TRIP PLANNING

Perspective allows the pilot to view trip planning information, fuel information, and other information for a specified flight plan or flight plan leg based on automatic data, or based on manually entered data. Weight planning is also available, based on manually entered fuel data and the active flight plan (to estimate remaining fuel).

TRIP PLANNING

All of the input of data needed for calculation and viewing of the statistics is done on the Trip Planning Page located in the AUX Page Group.

Selected Flight Plan Segment
 - FPL Number/Cumulative Legs (CUM or REM) or Leg Number (NN)
 - Waypoints Defining Selected Flight Plan/Flight Plan Leg

Preview of Selected Flight Plan/Flight Plan Leg

Trip Statistics
 Desired Track -
 Distance -
 Est. Time Enroute -
 Est. Time of Arrival -
 Enroute Safe Altitude -
 Sunrise Time (local) -
 Sunset Time (local) -

Fuel Statistics
 Efficiency -
 Total Endurance -
 Remaining Fuel -
 Remaining Endurance -
 Fuel Required -
 Total Range -

Trip Planning Page Mode
 - Automatic/Manual

Trip Input Data (sensor/pilot)
 - Departure Time (local)
 - Ground Speed
 - Fuel Flow
 - Fuel On Board Aircraft
 - Calibrated Airspeed
 - Indicated Altitude
 - Barometric Pressure
 - Total Air Temperature

Other Statistics
 - Density Altitude
 - True Airspeed (TAS)

Softkeys
 - Automatic/Manual Page Mode
 - Flight Plan/Waypoint Mode

Figure 5-114 Trip Planning Page

The trip planning inputs are based on sensor inputs (automatic page mode) or on pilot inputs (manual page mode). Some additional explanation of the sources for some of the inputs is as follows:

- Departure time (DEP TIME) - This defaults to the current time in automatic page mode. The computations are from the aircraft present position, so the aircraft is always just departing.
- Calibrated airspeed (CALIBRATED AS) - The primary source is from the air data system, and the secondary source of information is GPS ground speed.
- Indicated altitude (IND ALTITUDE) - The primary source is the barometric altitude, and the secondary source of information is GPS altitude.

TRIP STATISTICS

The trip statistics are calculated based on the selected starting and ending waypoints and the trip planning inputs.

In flight plan mode (FPL) with a stored flight plan selected (NN), and the entire flight plan (CUM) selected, the waypoints are the starting and ending waypoints of the selected flight plan.

In flight plan mode (FPL) with a stored flight plan selected (NN), and a specific leg (NN) selected, the waypoints are the endpoints of the selected leg.

In flight plan mode (FPL) with the active flight plan selected (00), and the remaining flight plan (REM) selected, the 'from' waypoint is the present position of the aircraft and the 'to' waypoint is the endpoint of the active flight plan.

In flight plan mode (FPL) with the active flight plan selected (00), and a specific leg (NN) selected, the 'from' waypoint is the current aircraft position and the 'to' waypoint is the endpoint of the selected leg.

In waypoint (WPTS) mode these are manually selected waypoints (if there is an active flight plan, these default to the endpoints of the active leg).

Some of the calculated trip statistics are dashed when the selected leg of the active flight plan has already been flown.

- Desired Track (DTK) - DTK is shown as nnn° and is the desired track between the selected waypoints. It is dashed unless only a single leg is selected.
- Distance (DIS) - The distance is shown in tenths of units up to 99.9, and in whole units up to 9999.
- Estimated time enroute (ETE) - ETE is shown as hours:minutes until less than an hour, then it is shown as minutes:seconds.
- Estimated time of arrival (ETA) - ETA is shown as hours:minutes and is the local time at the destination.
 - If in waypoint mode then the ETA is the ETE added to the departure time.
 - If a flight plan other than the active flight plan is selected it shows the ETA by adding to the departure time all of the ETEs of the legs up to and including the selected leg. If the entire flight plan is selected, then the ETA is calculated as if the last leg of the flight plan was selected.
 - If the active flight plan is selected the ETA reflects the current position of the aircraft and the current leg being flown. The ETA is calculated by adding to the current time the ETEs of the current leg up to and including the selected leg. If the entire flight plan is selected, then the ETA is calculated as if the last leg of the flight plan was selected.
- Enroute safe altitude (ESA) - The ESA is shown as nnnnnFT
- Destination sunrise and sunset times (SUNRISE, SUNSET) - These times are shown as hours:minutes and are the local time at the destination.

FUEL STATISTICS

The fuel statistics are calculated based on the selected starting and ending waypoints and the trip planning inputs. Some of the calculated trip statistics are dashed when the selected leg of the active flight plan has already been flown.

- Fuel efficiency (EFFICIENCY) - This value is calculated by dividing the current ground speed by the current fuel flow.
- Time of fuel endurance (TOTAL ENDUR) - This time is shown as hours:minutes. This value is obtained by dividing the amount of fuel on board by the current fuel flow.
- Fuel on board upon reaching end of selected leg (REM FUEL) - This value is calculated by taking the amount of fuel onboard and subtracting the fuel required to reach the end of the selected leg.
- Fuel endurance remaining at end of selected leg (REM ENDUR) - This value is calculated by taking the time of fuel endurance and subtracting the estimated time enroute to the end of the selected leg.
- Fuel required for trip (FUEL REQ) - This value is calculated by multiplying the time to go by the fuel flow.
- Total range at entered fuel flow (TOTAL RANGE) - This value is calculated by multiplying the time of fuel endurance by the ground speed.

OTHER STATISTICS

These statistics are calculated based on the system sensor inputs or the manual trip planning inputs.

- Density altitude (DENSITY ALT)
- True airspeed (TRUE AIRSPEED)

The pilot may select automatic (AUTO) or manual (MANUAL) page mode, and flight plan (FPL) or waypoint (WPTS) mode. In automatic page mode, only the FPL, LEG, or waypoint IDs are editable (based on FPL/WPTS selection).

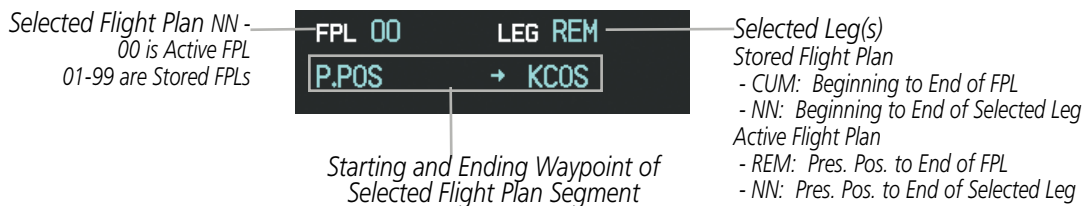

Figure 5-115 Trip Planning Page - Flight Plan Mode

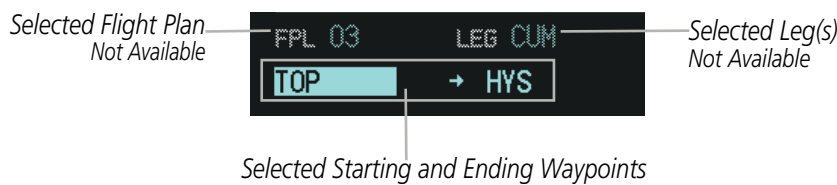

Figure 5-116 Trip Planning Page - Waypoint Mode

Selecting automatic or manual page mode:

Press the **AUTO** Softkey or the **MANUAL** Softkey; or press the **MENU** Key, highlight 'Auto Mode' or 'Manual Mode', and press the **ENT** Key.

Selecting flight plan or waypoint mode:

Press the **FPL** Softkey or the **WPTS** Softkey; or press the **MENU** Key, highlight 'Flight Plan Mode' or 'Waypoints Mode', and press the **ENT** Key.

Selecting a flight plan and leg for trip statistics:

- 1) Push the **FMS** Knob to activate the cursor in the flight plan number field.
- 2) Turn the small **FMS** Knob to select the desired flight plan number.
- 3) Turn the large **FMS** Knob to highlight 'CUM' or 'REM'. The statistics for each leg can be viewed by turning the small **FMS** Knob to select the desired leg. The Inset Map also displays the selected data.

Selecting waypoints for waypoint mode:

- 1) Press the **WPTS** Softkey; or press the **MENU** Key, highlight 'Waypoints Mode', and press the **ENT** Key. The cursor is positioned in the waypoint field directly below the FPL field.
- 2) Turn the **FMS** knobs to select the desired waypoint (or select from the Page Menu 'Set WPT to Present Position' if that is what is desired), and press the **ENT** Key. The cursor moves to the second waypoint field.
- 3) Turn the **FMS** knobs to select the desired waypoint, and press the **ENT** Key. The statistics for the selected leg are displayed.

In manual page mode, the other eight trip input data fields must be entered by the pilot, in addition to flight plan and leg selection.

Entering manual data for trip statistics calculations:

- 1) Press the **MANUAL** Softkey or select 'Manual Mode' from the Page Menu, and press the **ENT** Key. The cursor may now be positioned in any field in the top right two boxes.
- 2) Turn the **FMS** Knobs to move the cursor onto the DEP TIME field and enter the desired value. Press the **ENT** Key. The statistics are calculated using the new value and the cursor moves to the next entry field. Repeat until all desired values have been entered.

5.10 RAIM PREDICTION

RAIM (Receiver Autonomous Integrity Monitoring) is a GPS receiver function that performs a consistency check on all tracked satellites. RAIM ensures that the available satellite geometry allows the receiver to calculate a position within a specified RAIM protection limit (2.0 nm for oceanic, 2.0 nm for enroute, 1.0 nm for terminal, and 0.3 nm for non-precision approaches). During oceanic, enroute, and terminal phases of flight, RAIM is available nearly 100% of the time. The RAIM prediction function also indicates whether RAIM is available at a specified date and time. RAIM computations predict satellite coverage within ± 15 min of the specified arrival date and time. Because of the tighter protection limit on approaches, there may be times when RAIM is not available. RAIM prediction must be initiated manually if there is concern over SBAS coverage at the destination or some other reason that compromises navigation precision. If RAIM is not predicted to be available for the final approach course, the approach does not become active. If RAIM is not available when crossing the FAF, the missed approach procedure must be flown.



Figure 5-117 RAIM Prediction

Predicting RAIM availability at a selected waypoint:

- 1) Select the AUX-GPS Status Page.
- 2) Push the **FMS** Knob. The RAIM Prediction 'WAYPOINT' field is highlighted.
- 3) Turn the small **FMS** Knob to display the Waypoint Information Window. (Turning it clockwise displays a blank Waypoint Information Window, turning it counter-clockwise displays the Waypoint Information Window with a waypoint selection submenu allowing selection of active flight plan, nearest, recent, user, or airway waypoints).
- 4) Enter the identifier, facility, or city name of the departure waypoint; or select a waypoint from the submenu of waypoints and press the **ENT** Key to accept the waypoint entry.

- 5) Turn the **FMS** Knobs to enter an arrival time and press the **ENT** Key.
- 6) Turn the **FMS** Knobs to enter an arrival date and press the **ENT** Key.
- 7) Press the **ENT** Key with 'COMPUTE RAIM?' highlighted to begin the computation.

Predicting RAIM availability at the aircraft present position:

- 1) Select the AUX-GPS Status Page.
- 2) Push the **FMS** Knob. The RAIM Prediction 'WAYPOINT' field is highlighted.
- 3) Press the **MENU** Key, highlight 'Set WPT to Present Position', and press the **ENT** Key.
- 4) Press the **ENT** Key to accept the waypoint entry.
- 5) Turn the **FMS** Knobs to enter an arrival time and press the **ENT** Key.
- 6) Turn the **FMS** Knobs to enter an arrival date and press the **ENT** Key.
- 7) Press the **ENT** Key with 'COMPUTE RAIM?' highlighted to begin the computation.

Status of the RAIM computation for the selected waypoint, time, and date is displayed at the bottom of the RAIM PREDICTION Box as follows:

- 'COMPUTE RAIM?' - RAIM has not been computed.
- 'COMPUTING AVAILABILITY' - RAIM calculation is in progress.
- 'RAIM AVAILABLE' - RAIM is predicted to be available.
- 'RAIM NOT AVAILABLE' - RAIM is predicted to be unavailable.

The Satellite Based Augmentation System (SBAS) provides increased navigation accuracy when available. SBAS can be enabled or disabled manually on the GPS Status Page.



Figure 5-118 SBAS Display - Active

Enabling/Disabling SBAS:

- 1) Select the AUX-GPS Status Page.
- 2) Press the **SBAS** Softkey.
- 3) Push the **FMS** Knob, and turn the large **FMS** Knob to highlight 'EGNOS', 'MSAS' or 'WAAS'.
- 4) Press the **ENT** Key to disable SBAS. Press the **ENT** Key again to enable SBAS.



Figure 5-119 SBAS Display - Disabled

5.11 NAVIGATING A FLIGHT PLAN

The following discussion is an example of navigating a flight plan with the SBAS capable GPS system while Perspective provides vertical guidance through descents. A lateral flight plan (LNAV) would be navigated in much the same way, but would not include vertical guidance when the final approach course is active.



NOTE: The following example flight plan is for instructional purposes only. All database information depicted should be considered not current.

The example is a flight plan from KMKC to KCOS filed using the TIFTO2 departure, various Victor Airways, and the DBRY1 arrival with the transition at TBE. The flight plan includes an enroute altitude of 12,000 feet, an RNAV LPV (WAAS) approach selected for runway 35R, and a missed approach executed at the Missed Approach Point (MAP). A few enroute changes are demonstrated.

- 1) Prior to departure, the TIFTO2 departure, the airways, and the DBRY1 arrival at KCOS are loaded. See the Procedures section for loading departures and arrivals. Note the magenta arrow in the following figure indicating the active departure leg.

After takeoff, ATC assigns a heading of 240°.

- 2) The following figure shows the aircraft on the assigned heading of 240°. 'TERM' (Terminal) is the current CDI flight phase displayed on the HSI indicating 1.0 nm CDI scaling.

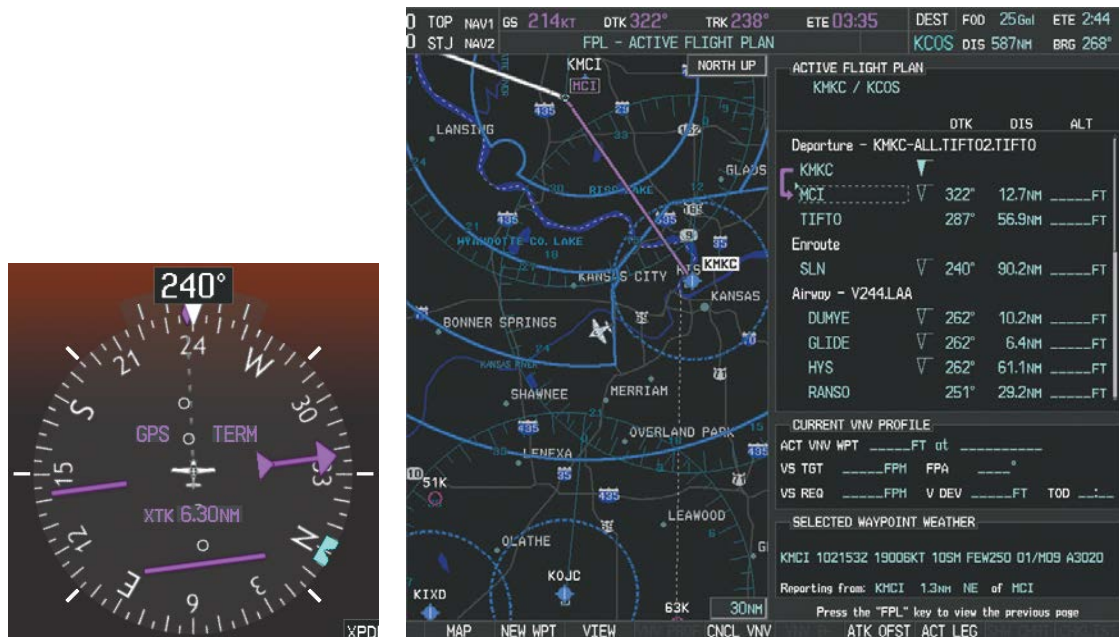

Figure 5-120 Assigned Heading of 240°

- 3) ATC now assigns routing to join V4. A heading of 290° is assigned to intercept V4. The aircraft turns to heading 290°.

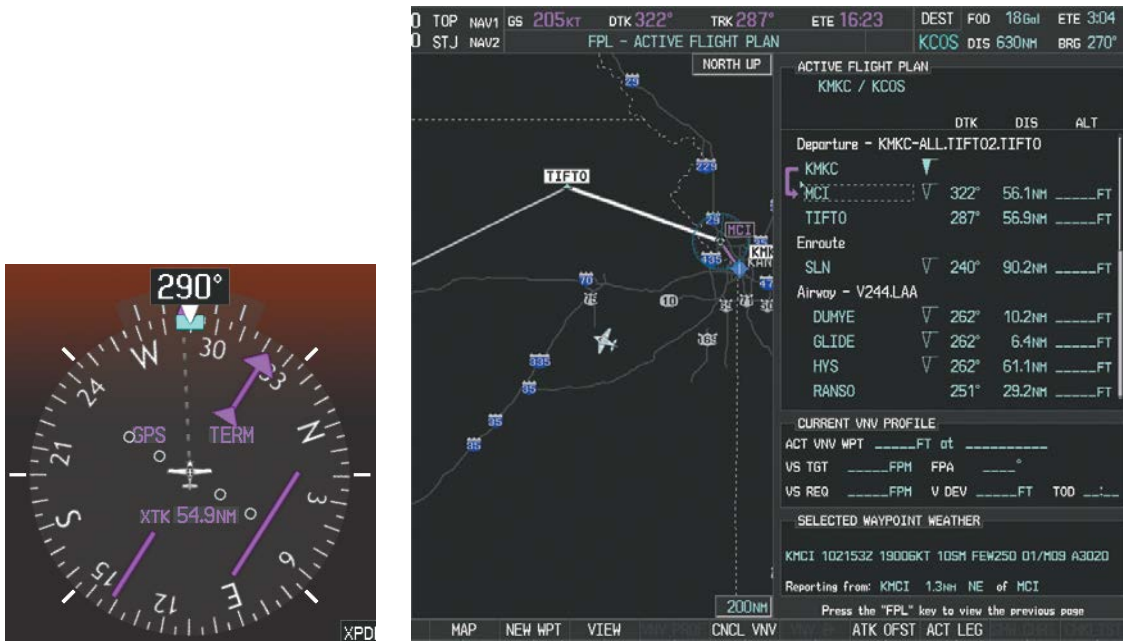

Figure 5-121 Assigned Heading of 290°

- 4) Enter V4 into the flight plan.
 - a) Push the **FMS** Knob to activate the cursor.
 - b) The desired entry point for V4 (TOP) must be entered. Turn the large **FMS** Knob to highlight the desired flight plan insertion point (SLN). When the V4 entry point (TOP) is inserted, it is placed immediately above the highlighted waypoint (SLN).

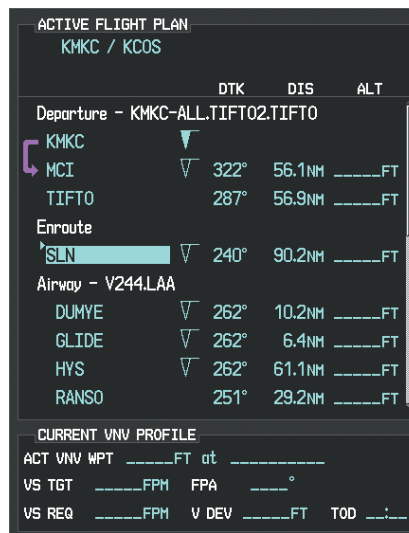

Figure 5-122 Begin Adding V4 to the Flight Plan

- c) Turn the small **FMS** Knob to display the Waypoint Information Window. Enter the desired entry point for V4, Topeka VOR (TOP).



Figure 5-123 Entering V4 Entry Point

- d) Press the **ENT** Key. TOP is inserted into the flight plan.

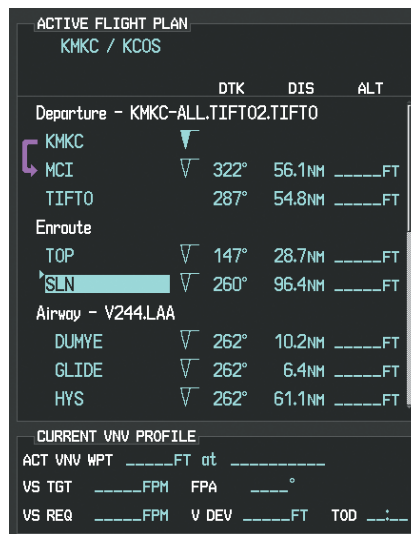

Figure 5-124 TOP Inserted into the Flight Plan

- e) With SLN still highlighted, turn the small **FMS** Knob clockwise. The Waypoint Information Page is displayed and the **LD AIRWY** Softkey is now available.
- f) Press the **LD AIRWY** Softkey to display the list of available airways for TOP.



Figure 5-125 List of Available Airways for TOP

- g) Turn either **FMS** Knob to highlight V4 in the list.
- h) Press the **ENT** Key. The list of available exits for V4 is now displayed.

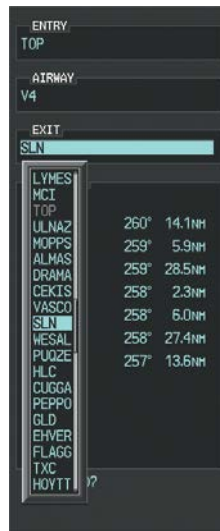

Figure 5-126 List of Available Exits for V4

- i) If necessary, turn either **FMS** Knob to select the desired exit. In this case Salina VOR (SLN) is selected.

- j) Press the **ENT** Key. The selected airway and exit are displayed, and the prompt "LOAD?" highlighted.

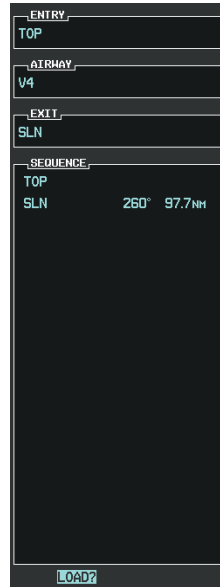

Figure 5-127 Ready to Load V4

- k) Press the **ENT** Key.
- l) V4 is now loaded into the flight plan.

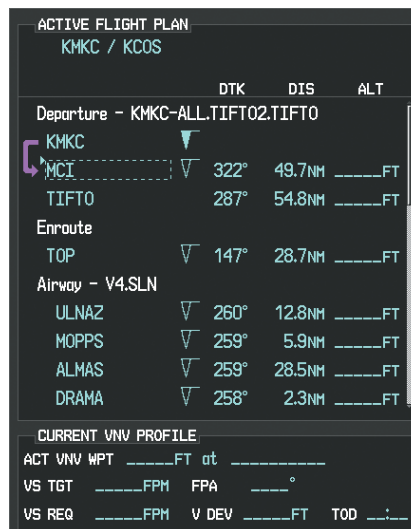

Figure 5-128 V4 is Loaded in the Flight Plan

- 5) Making V4 the active leg of the flight plan.
 - a) Push the **FMS** Knob to activate the cursor.
 - b) Turn the large **FMS** Knob to highlight ULNAZ. The TO waypoint of the leg is selected in order to activate the leg.
 - c) Press the **ACT LEG** Softkey. The confirmation window is now displayed. Note the TOP to ULNAZ leg is actually part of V4.

- SYSTEM OVERVIEW
- FLIGHT INSTRUMENTS
- EIS
- AUDIO PANEL & CNS
- FLIGHT MANAGEMENT
- HAZARD AVOIDANCE
- AFCS
- ADDITIONAL FEATURES
- APPENDICES
- INDEX

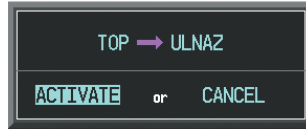

Figure 5-129 Confirm Active Leg

- d) Verify the displayed leg is the desired leg and press the **ENT** Key. The magenta arrow in the flight plan window and magenta line on the map indicating V4 is now the active flight plan leg. Note the phase of flight remained in Terminal (TERM) mode up to this point because a departure leg was active. Since a leg after the departure is now active, the current CDI flight phase is ENR (Enroute) and CDI scaling has changed to 2.0 nm.

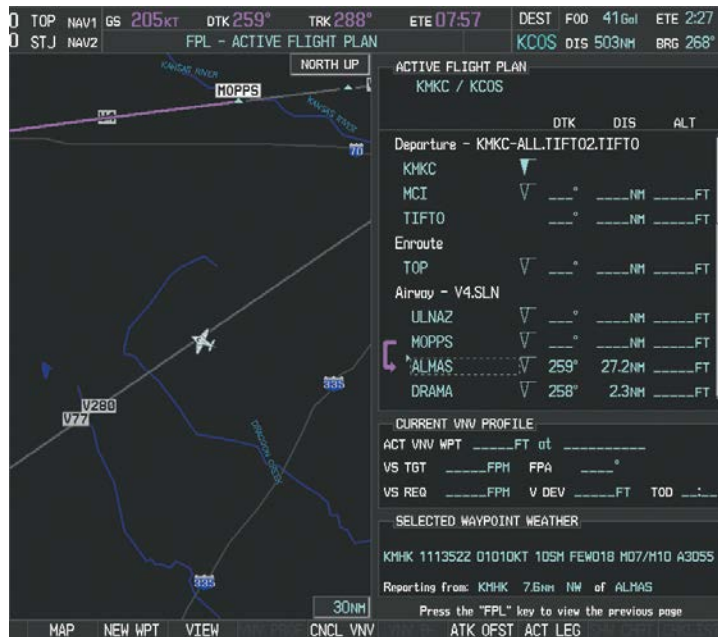

Figure 5-130 V4 Now Active Leg

- 6) The aircraft continues on heading 290°. When crosstrack distance is less than 2.0 nm, the XTK disappears from the HSI and the CDI is positioned on the last dot indicating a 2.0 nm distance from the centerline of the next course.

7) As the CDI approaches center, the aircraft turns onto the active leg.



Figure 5-131 Turn on to Active Leg

8) At SLN, Victor Airway 244 (V244) is intercepted. Turn prompts are displayed in the PFD Navigation Status Box.

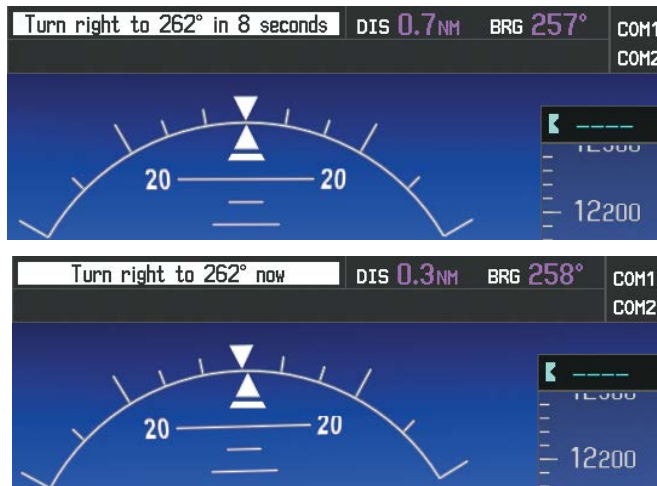

Figure 5-132 Turn to Intercept V244

9) V244 is now the active flight plan leg.



Figure 5-133 V244 Now Active Leg

10) At Lamar VOR (LAA) V263 is intercepted.



Figure 5-134 HYS to LAA Leg Active

- 11) ATC grants clearance to proceed direct to the OPSHN intersection to begin the arrival procedure. ATC advises to expect an altitude of 10,000 feet at OPSHN.
 - a) Push the **FMS** Knob to activate the cursor.
 - b) Turn the large **FMS** Knob to select OPSHN in the flight plan list.
 - c) Press the **→** Key. The Direct-to Window is now displayed.



Figure 5-135 Direct To OPSHN

- d) Turn the large **FMS** Knob to place the cursor in the VNV altitude field.



Figure 5-136 Enter VNV Altitude

SYSTEM OVERVIEW

FLIGHT INSTRUMENTS

EIS

AUDIO PANEL & CNS

FLIGHT MANAGEMENT

HAZARD AVOIDANCE

AFCS

ADDITIONAL FEATURES

APPENDICES

INDEX

- e) An altitude of 10,000 feet is entered as requested by ATC.
- f) Press the **ENT** Key. The cursor is now displayed in the VNV offset field.



Figure 5-137 Enter VNV Offset Distance

- g) Enter the offset, or distance from the waypoint at which to reach the selected altitude. In this case, three miles prior to OPSHN is entered. In other words, the system gives vertical guidance so the aircraft arrives at an altitude of 10,000 feet three miles prior to OPSHN.
- h) Press the **ENT** Key twice to activate the direct-to. Note, the magenta arrow indicating the direct-to OPSHN after the offset waypoint for OPSHN. The preceding offset waypoint indicates the offset distance and altitude that were previously entered. The remaining waypoints in the loaded arrival procedure have no database specified altitudes, therefore, dashes are displayed. Keep the CDI centered and maintain a track along the magenta line to OPSHN.

Note the Direct-to waypoint is within the loaded arrival procedure, therefore, phase of flight scaling for the CDI changes to Terminal Mode and is annunciated by displaying 'TERM' on the HSI.



NOTE: If the loaded arrival procedure has waypoints with altitude constraints retrieved from the database to be used as is, the altitude must be manually accepted by placing the cursor over the desired altitude, then pressing the ENT Key. The altitude is now displayed as cyan meaning it is used by the system to determine vertical speed and deviation guidance.



Figure 5-138 Direct-to Active

- 12) The aircraft is proceeding to OPSHN. The expected approach is the RNAV LPV approach to runway 35R, so it is selected.
 - a) Press the **PROC** Key to display the Procedures Window.
 - b) 'SELECT APPROACH' should be highlighted.

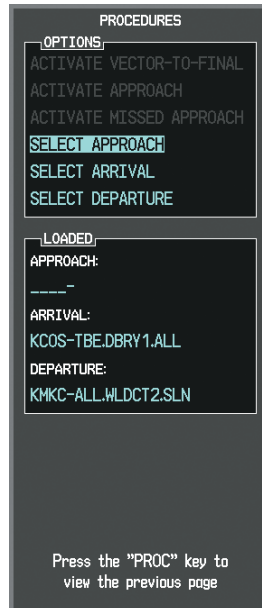

Figure 5-139 Procedures Window

- c) Press the **ENT** Key. A list of available approaches for the destination airport is displayed.

- SYSTEM OVERVIEW
- FLIGHT INSTRUMENTS
- EIS
- AUDIO PANEL & CNS
- FLIGHT MANAGEMENT
- HAZARD AVOIDANCE
- AFCS
- ADDITIONAL FEATURES
- APPENDICES
- INDEX



Figure 5-140 List of Available Approaches

- d) Turn either **FMS** Knob to select the RNAV LPV approach for 35R.
- e) Press the **ENT** Key. A list of available transitions for the selected approach is displayed.



Figure 5-141 List of Available Transitions

- f) Turn either **FMS** Knob to select the desired transition. In this case, the Initial Approach Fix (IAF) at HABUK is used.
- g) Press the **ENT** Key.
- h) Barometric Minimums

To set 'MINIMUMS', turn the small **FMS** Knob to select 'BARO', and press the **ENT** Key. Turn the small **FMS** Knob to select the altitude, and press the **ENT** Key.

Or:

To skip setting minimums, press the **ENT** Key.

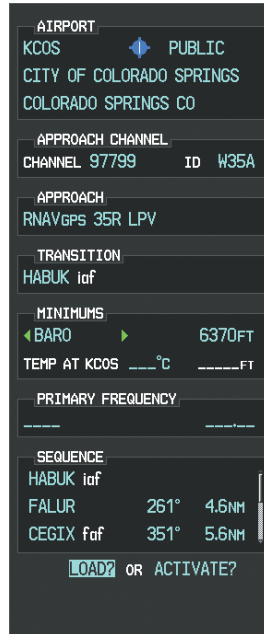

Figure 5-142 Barometric Minimums Set

- i) With 'LOAD?' highlighted, again press the **ENT** Key. The selected approach is added to the flight plan.



Figure 5-143 Loaded Approach

- 13) Note the altitude constraints associated with each of the approach waypoints. These altitudes are loaded from the database and are displayed as cyan text, indicating these values are “designated” for use in computing vertical deviation guidance.

Note: To no longer use the displayed altitude for calculating vertical deviation guidance, perform the following:

- a) Push the **FMS** Knob to activate the cursor.
- b) Turn the small **FMS** Knob to highlight the desired altitude.
- c) Press the **CLR** Key.
- d) Push the **FMS** Knob to deactivate the cursor.

After making the altitude “non-designated”, it is displayed as white text.

Altitude constraint values associated with the Final Approach Fix (FAF) and waypoints beyond the FAF cannot be designated for vertical guidance. These altitude values are always displayed as white text. Vertical guidance from the FAF and on to the Missed Approach Point (MAP) is given using the WAAS GPS altitude source, therefore, the displayed altitude values are for reference only.

ACTIVE FLIGHT PLAN			
KMKC / KCOS			
	DTK	DIS	ALT
FSHER	352°	9.8NM	12000FT
PYNON	352°	11.9NM	10100FT
Approach - KCOS-RNAV 35R GPS LPV			
HABUK iaf	021°	5.9NM	9000FT
FALUR	261°	5.0NM	8600FT
CEGIX faf	351°	6.0NM	7800FT
RW35R map	351°	5.1NM	
6368FT	348°	0.4NM	6370FT
MOGAL mahp			10000FT
HOLD	168°	6.0NM	

CURRENT VNV PROFILE			
ACT VNV WPT	9000FT	at	HABUK iaf
VS TGT	_____FPM	FPA	-1.7°
VS REQ	_____FPM	V DEV	_____FT
		TOD	___:___

Figure 5-144 Vertical Guidance is Active to the FAF

- 14) As the aircraft approaches OPSHN, it may be desirable to adjust the speed, or steepness of the upcoming descent. The default Flight Path Angle (FPA) is -3.0 degrees and a required vertical speed is computed to maintain the -3.0 FPA. To change the vertical flight path, perform the following steps.

- a) Press the **VNV PROF** Softkey to place the cursor in the target vertical speed field (VS TGT).
- b) At this point, the descent vertical speed can be selected, or the FPA can be selected. Turn the large **FMS** Knob to select the desired selection field, then turn the small **FMS** Knob to enter the desired value.

Note the information now displayed in the ‘CURRENT VNV PROFILE’ box. Also, note the offset waypoint (orange box) and gray circle are now displayed on the map. The gray circle marks the Top of Descent (TOD). In this example, vertical guidance is provided at the TOD that results in a -3.0 degree FPA descent to an altitude of 10,000 feet upon reaching the offset waypoint.



Figure 5-145 Adjusting the Descent

- c) Press the **ENT** Key.
- 15) As shown below, the aircraft is approaching TOD. Note the target vertical speed required to reach the selected altitude. The Vertical Deviation Indicator (VDI) and the Required Vertical Speed Indicator (RVSI) are now displayed on the PFD. When the aircraft is within one minute of the TOD, it is annunciated, and an aural alert 'Vertical track' will be heard.



Figure 5-146 Approaching Top of Descent (TOD)

- SYSTEM OVERVIEW
- FLIGHT INSTRUMENTS
- EIS
- AUDIO PANEL & CNS
- FLIGHT MANAGEMENT
- HAZARD AVOIDANCE
- AFCS
- ADDITIONAL FEATURES
- APPENDICES
- INDEX

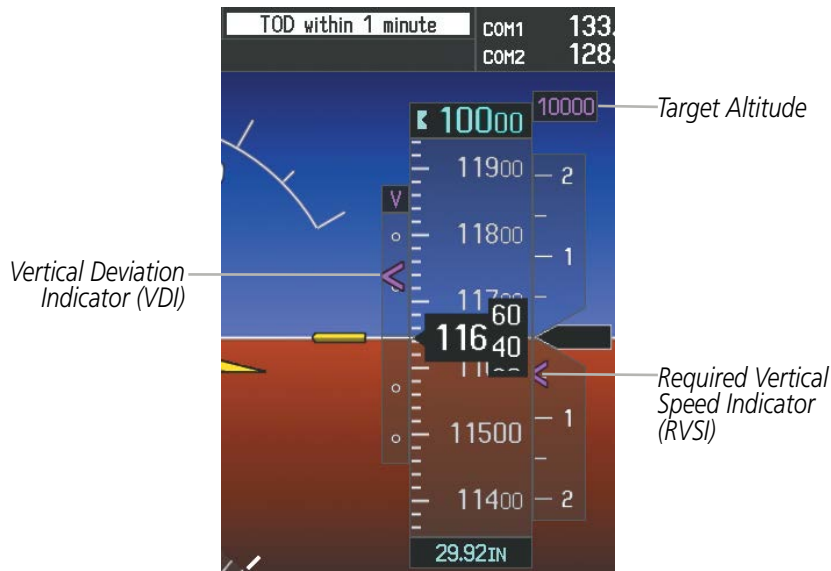

Figure 5-147 VDI & RVSI Upon Reaching Top of Descent (TOD)

16) Upon reaching TOD, a descent vertical speed is established by placing the VSI pointer in line with the RVSI.

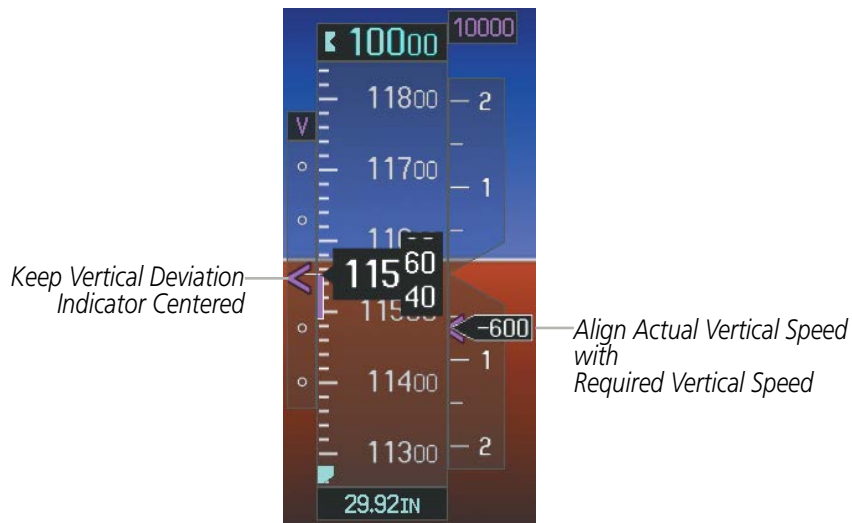

Figure 5-148 VDI & RVSI Showing Correctly Established Descent

17) When the aircraft is one minute from the bottom of descent (BOD) it is annunciated. Upon reaching the offset waypoint for OPSHN, the aircraft is at 10,000 feet.

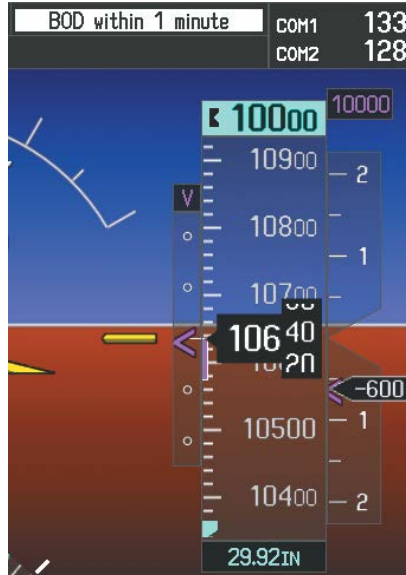

Figure 5-149 Approaching Bottom of Descent (BOD) at OPSHN Offset Waypoint

- 18) The aircraft is approaching OPSHN. The upcoming turn and next heading are announced at the top left of the PFD. Initiate the turn and maneuver the aircraft on a track through the turn radius to intercept the magenta line for the OPSHN to FSHER leg and center the CDI.

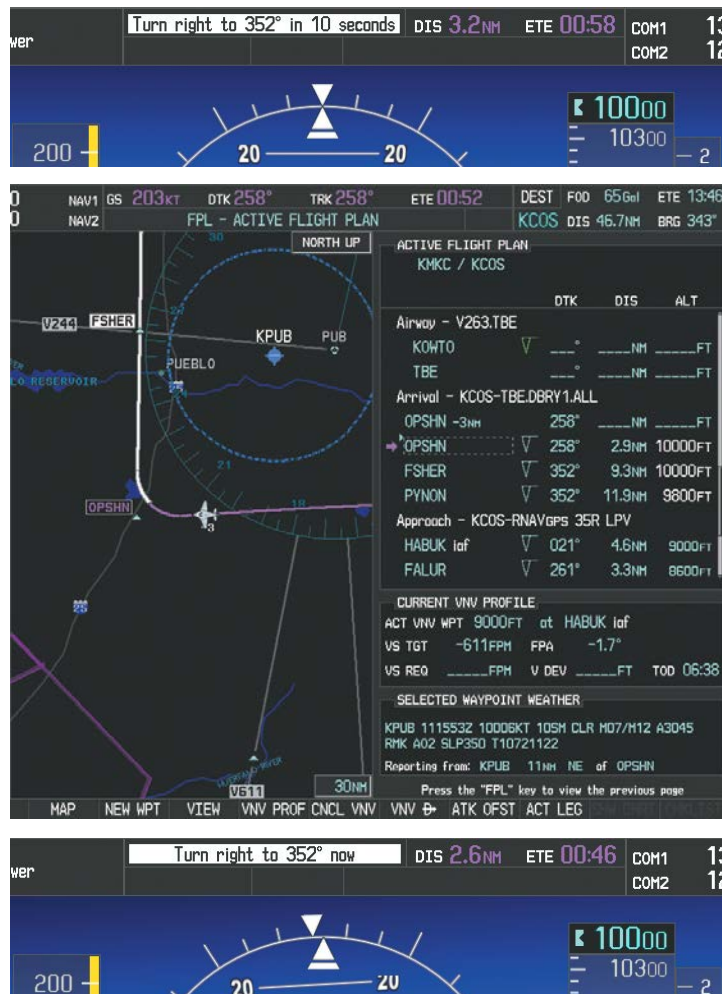

Figure 5-150 Turn to intercept OPSHN to FSHER Leg

- 19) After passing OPSHN, the next leg of the arrival turns magenta. The magenta arrow in the flight plan list now indicates the OPSHN to FSHER leg of the arrival procedure is now active.



Figure 5-151 Tracking the OPSHN to FSHER Leg

- 20) The flight continues through the arrival procedure to PYNON. At a point 31 nm from the destination airport, the phase of flight scaling for the CDI changes to Terminal Mode and is annunciated by displaying 'TERM' on the HSI.

A descent to HABUK is in the next leg. Note the TOD point on the map. Annunciations for the upcoming turn and descent, as well as the VDI and RVSI, appear on the PFD as the flight progresses.



Figure 5-152 Approaching PYNON

SYSTEM OVERVIEW

FLIGHT INSTRUMENTS

EIS

AUDIO PANEL & CNS

FLIGHT MANAGEMENT

HAZARD AVOIDANCE

AFCS

ADDITIONAL FEATURES

APPENDICES

INDEX

21) Upon passing PYNON the approach procedure automatically becomes active. The approach may be activated at any point to proceed directly to the IAF. In this example, the aircraft has progressed through the final waypoint of the arrival and the flight plan has automatically sequenced to the IAF as the active leg, activating the approach procedure.



Figure 5-153 Approach is Now Active

Note: To manually activate the approach procedure, perform the following steps:

- a) Press the **PROC** Key.
- b) Turn the large **FMS** Knob to highlight 'ACTIVATE APPROACH'.
- c) Press the **ENT** Key to activate the approach.

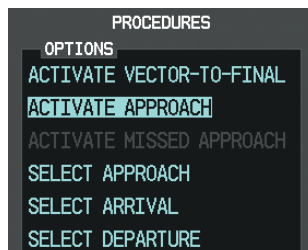

Figure 5-154 Manually Activate Approach

- 22) The IAF is the next waypoint. At the TOD, establish a descent vertical speed as previously discussed in Step 16. The aircraft altitude is 9,000 feet upon reaching HABUK.



Figure 5-155 Descending Turn to the Initial Approach Fix (IAF)

- 23) After crossing FALUR the next waypoint is the FAF. The flight phase changes to LPV on the HSI indicating the current phase of flight is in Approach Mode and the approach type is RNAV LPV. CDI scaling changes accordingly and is used much like a localizer when flying an ILS approach. The RVSI is no longer displayed and the VDI changes to the Glidepath Indicator when the final approach course becomes active.

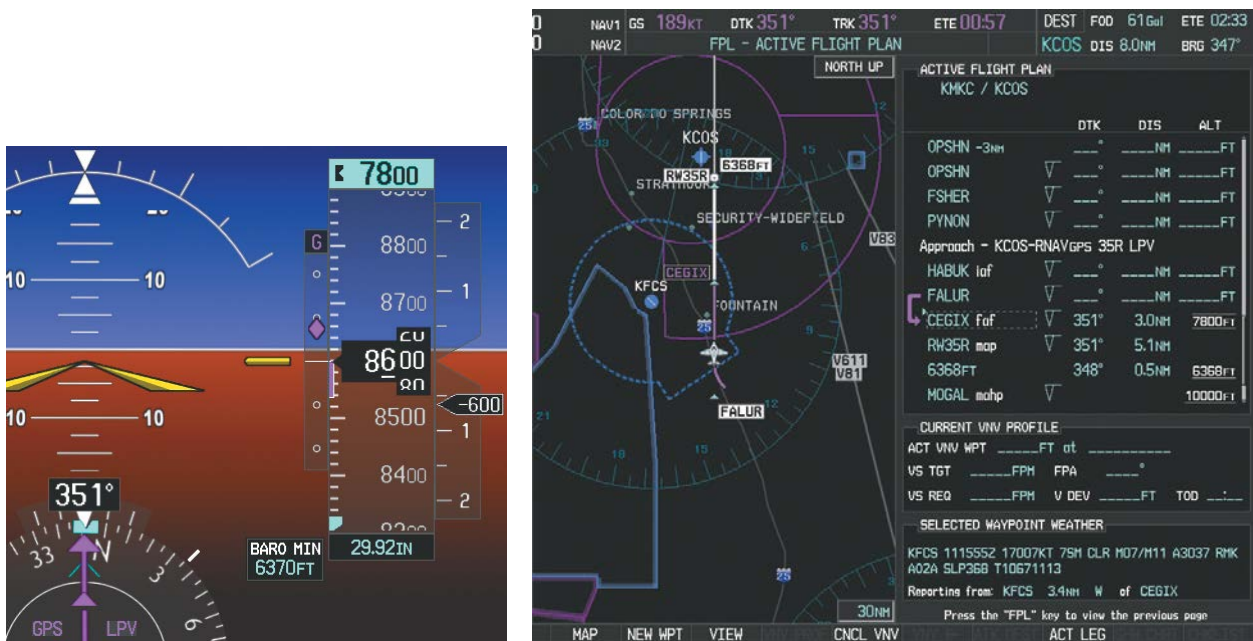

Figure 5-156 Descending to the FAF

The descent continues through the FAF (CEGIX) using the Glidepath Indicator, as one would use a glideslope indicator, to obtain an altitude "AT" 7,800 feet at the FAF. Note the altitude restriction lines over and under (At) the altitude in the 'ALT' field.

- 24) After crossing CEGIX, the aircraft continues following the glidepath to maintain the descent to "AT or ABOVE" 6,370 feet at the Missed Approach Point (MAP) (RW35R).



Figure 5-157 Descending to the Missed Approach Point

In this missed approach procedure, the altitude immediately following the MAP (in this case '6368ft') is not part of the published procedure. It is simply a Course to Altitude (CA) leg which guides the aircraft along the runway centerline until the altitude required to safely make the first turn toward the MAHP is exceeded. This altitude is provided by Jeppesen, and may be below, equal to, or above the published minimums for this approach. In this case, if the aircraft altitude is below the specified altitude (6,368 feet) after crossing the MAP, a direct-to is established to provide a course on runway heading until an altitude of 6,368 feet is reached. After reaching 6,368 feet, a direct-to is established to the published MAHP (in this case MOGAL). If the aircraft altitude is above the specified altitude after crossing the MAP, a direct-to is established to the published fix (MOGAL) to begin the missed approach procedure.

In some missed approach procedures this Course to Altitude leg may be part of the published procedure. For example, a procedure may dictate a climb to 5,500 feet, then turn left and proceed to the Missed Approach Hold Point (MAHP). In this case, the altitude would appear in the list of waypoints as '5500ft'. Again, if the aircraft altitude is lower than the prescribed altitude, a direct-to is established on a Course to Altitude leg when the missed approach procedure is activated.

25) Upon reaching the MAP, it is decided to execute a missed approach. Automatic waypoint sequencing is suspended past the MAP. Press the **SUSP** Softkey on the PFD to resume automatic waypoint sequencing through the missed approach procedure.

A direct-to is initiated to MOGAL, which is the Missed Approach Hold Point (MAHP). The aircraft is climbing to 10,000 feet. The CDI flight phase now changes from LPV to MAPR as seen on the HSI.

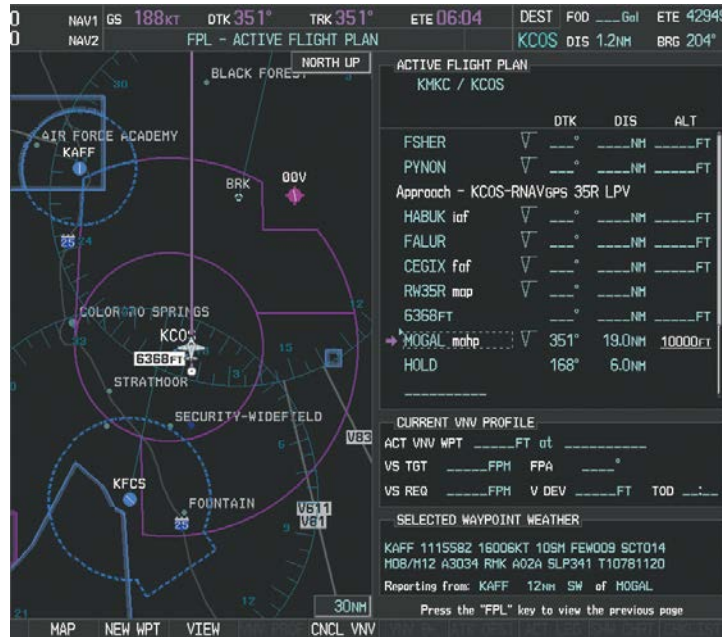

Figure 5-158 Missed Approach Active

- 26) The aircraft continues climbing to "AT or ABOVE" 10,000 feet at MOGAL. A holding pattern is established at the MAHP (MOGAL).



Figure 5-159 Establishing the Holding Pattern

- 27) The aircraft maintains 10,000 feet while following the magenta line through the hold.



Figure 5-160 Hold Established

5.12 ABNORMAL OPERATION

This section discusses the Dead Reckoning mode of operation and the subsequent indications.



NOTE: *Dead Reckoning Mode only functions in Enroute (ENR) or Oceanic (OCN) phase of flight. In all other phases, an invalid GPS solution produces a "NO GPS POSITION" annunciation on the map and Perspective stops using GPS.*

While in Enroute or Oceanic phase of flight, if the system detects an invalid GPS solution or is unable to calculate a GPS position, the system automatically reverts to Dead Reckoning (DR) Mode. In DR Mode, the system uses its last-known position combined with continuously updated airspeed and heading data (when available) to calculate and display the aircraft's current estimated position.

It is important to note that estimated navigation data supplied by Perspective in DR Mode may become increasingly unreliable and must not be used as a sole means of navigation. If while in DR Mode airspeed and/or heading data is also lost or not available, the DR function may not be capable of accurately tracking estimated position and, consequently, the system may display a path that is different than the actual movement of the aircraft. Estimated position information displayed by Perspective through DR while there is no heading and/or airspeed data available should not be used for navigation.

DR Mode is inherently less accurate than the standard GPS/SBAS Mode due to the lack of satellite measurements needed to determine a position. Changes in wind speed and/or wind direction compounds the relative inaccuracy of DR Mode. Because of this degraded accuracy, other navigation equipment must be relied upon for position awareness until GPS-derived position data is restored.

DR Mode is indicated on the system by the appearance of the letters 'DR' superimposed in amber over the 'own aircraft' symbol. In addition, 'DR' is prominently displayed in amber on the HSI slightly above and to the right of the aircraft symbol on the CDI. The CDI deviation bar remains, but is removed from the display after 20 minutes in DR Mode. The autopilot will remain coupled in DR mode as long as the deviation info is available (20 min.) Lastly, but at the same time, a 'GPS NAV LOST' alert message appears on the PFD. Normal navigation using GPS/SBAS source data resumes automatically once a valid GPS solution is restored.

As a result of operating in DR Mode, all GPS-derived data is computed based upon an estimated position and is displayed as amber text on the display to denote degraded navigation source information.

Also, while Perspective is in DR Mode, the autopilot does not couple to GPS, and TAWS, Terrain-SVT, and Terrain Proximity are disabled. Additionally, the accuracy of all nearest information (airports, airspaces, and waypoints) is questionable. Finally, airspace alerts continue to function, but with degraded accuracy.

- SYSTEM OVERVIEW
- FLIGHT INSTRUMENTS
- EIS
- AUDIO PANEL & CNS
- FLIGHT MANAGEMENT
- HAZARD AVOIDANCE
- AFCS
- ADDITIONAL FEATURES
- APPENDICES
- INDEX

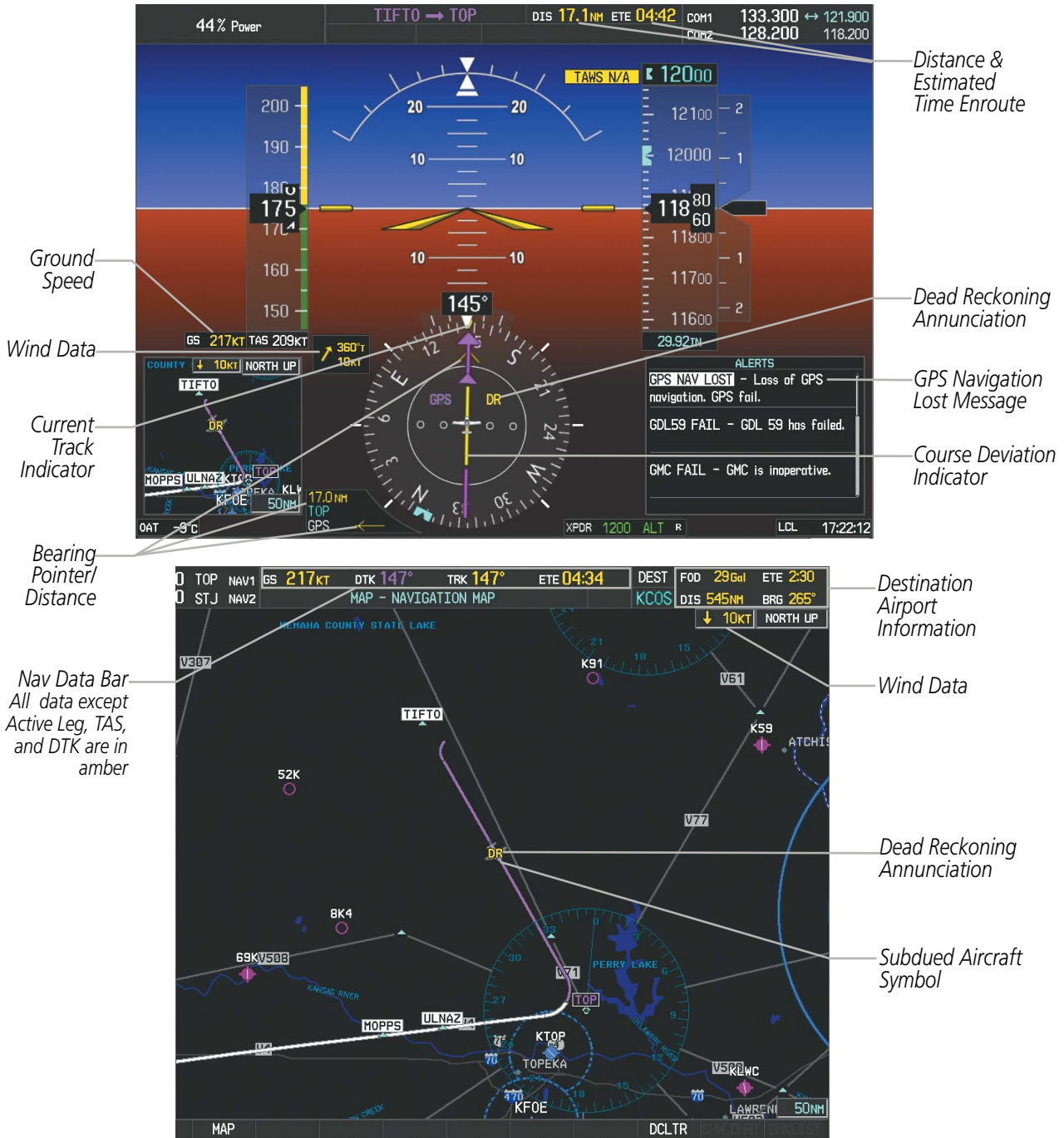

Figure 5-161 Dead Reckoning Mode - GPS Derived Data Shown in Amber



NOTE: The Inset Map is removed from the PFD any time aircraft pitch is greater than +30° or less than -20°, or when a 65° bank angle is reached.

SECTION 6 HAZARD AVOIDANCE

Hazard avoidance features available for Perspective® are designed to aid situational awareness and provide advisory information with regard to potential hazards to flight safety associated with weather, terrain, and air traffic.

Weather

- GDL 69/69A or GDL 69/69A SXM SiriusXM Weather (Optional)
- GSR 56 Garmin Connex Weather (Optional)
- GDL 88 Flight Information Services-Broadcast (FIS-B) Weather (Optional)
- On-Board Lightning Detection System (Optional)

Terrain Avoidance

- Terrain Proximity
- Terrain-SVS (Standard with SVT Option)
- Terrain Awareness and Warning System - Class B (TAWS-B) (Optional)

Traffic

- Garmin GTS 800 Traffic Advisory System (TAS) (Optional)
- Avidyne TAS610® TAS (Optional)
- L-3 SKYWATCH® (SKY497) TAS (Optional)
- Garmin GDL 88 Automatic Dependent Surveillance-Broadcast (ADS-B) Traffic

6.1 SIRIUSXM WEATHER



WARNING: Do not use data link weather information for maneuvering in, near, or around areas of hazardous weather. Information contained within data link weather products may not accurately depict current weather conditions.



WARNING: Do not use the indicated data link weather product age to determine the age of the weather information shown by the data link weather product. Due to time delays inherent in gathering and processing weather data for data link transmission, the weather information shown by the data link weather product may be significantly older than the indicated weather product age.

The optional GDL 69/69A or GDL69/69A SXM is a remote-mounted data link satellite receiver. Differences in the receiver models, where applicable, are discussed throughout this section; refer to appropriate aircraft documentation to determine the receiver model installed in this aircraft. Received graphical weather information and associated text is displayed on the Multi Function Display (MFD) and the Primary Flight Display (PFD) Inset Map. The GDL 69A and GDL 69A SXM can also receive SiriusXM Satellite Radio entertainment services. Both weather data and audio entertainment programming operate in the S-band frequency range to provide continuous reception capabilities at any altitude throughout North America.

Services from SiriusXM are subscription-based. For more information on specific service packages, visit www.siriusxm.com.

ACTIVATING SERVICES

Before SiriusXM Weather and SiriusXM Satellite Radio can be used, the service must be activated. Service is activated by providing coded IDs unique to the installed receiver. SiriusXM Satellite Radio (audio) and SiriusXM Weather (data) services each have coded IDs. The Data and Audio Radio IDs must be provided to activate the weather service and entertainment subscriptions, respectively. These IDs are located on:

- The XM Information Page on the MFD (Figure 6-1)
- The XM Satellite Radio Activation Instructions included with the unit
- The label on the back of the Data Link Receiver

Contact the installer if the Audio and Data Radio IDs cannot be located.

SiriusXM uses the coded IDs to send an activation signal that allows the system to provide weather data and/or entertainment programming provided through the receiver.

Establishing an account for SiriusXM services:

- 1) Select the XM Page in the AUX Page Group.
- 2) Press the **INFO** Softkey to display the AUX - XM Information Page.
- 3) Note the Data Radio ID (for SiriusXM Weather) and the Audio Radio ID (for SiriusXM Satellite Radio).
- 4) Contact SiriusXM Customer Service using the phone number listed on its website, www.siriusxm.com.
- 5) Provide SiriusXM Customer Service the Audio and/or Data Radio IDs, payment information, and the desired weather product subscription package.

Activating the SiriusXM Weather service:

- 1) Once a SiriusXM Weather account has been established, select the XM Page in the Auxiliary Page Group.
- 2) Press the **INFO** Softkey to display the XM Information Page.
- 3) View the list of supported Weather Products. A white empty box appears next to an unavailable weather product; a green filled box appears next to an available weather product. During activation, it may take several minutes for supported weather products in the selected subscription Service Class to become available.
- 4) When the available weather products displayed match the weather products offered in the selected SiriusXM Weather product subscription Service Class, select the **LOCK** Softkey.
- 5) Turn the large **FMS** Knob to highlight 'YES'.
- 6) To complete activation, press the **ENT** Key.



Figure 6-1 XM Information Page

USING SIRIUSXM WEATHER PRODUCTS

The principal map for viewing SiriusXM Weather information is the Weather Data Link (XM) Page in the Map Page Group. This is the only map display capable of showing information for all available SiriusXM Weather products.

Viewing the Weather Data Link (XM) Page:

- 1) Turn the large **FMS** Knob to select the Map Page Group.
- 2) Turn the small **FMS** Knob to select the Weather Data Link (XM or CNXT) Page.

If the name of another weather service provider is listed in the page title (such as 'CNXT'), proceed to the following steps in order to change the weather data link source to display SiriusXM Weather.

Changing the data link weather source to SiriusXM:

- 1) If necessary, follow the previous procedure to select the Weather Data Link (CNXT) Page.
- 2) Press the MENU Key.
- 3) Turn the large **FMS** Knob to select 'Display XM Weather' and press the **ENT** Key. The page title changes to 'Weather Data Link (XM)' to indicate SiriusXM Weather is the selected weather data link source.

The available softkeys and displayed data link weather information on the navigation maps correspond to the selected data link weather source.

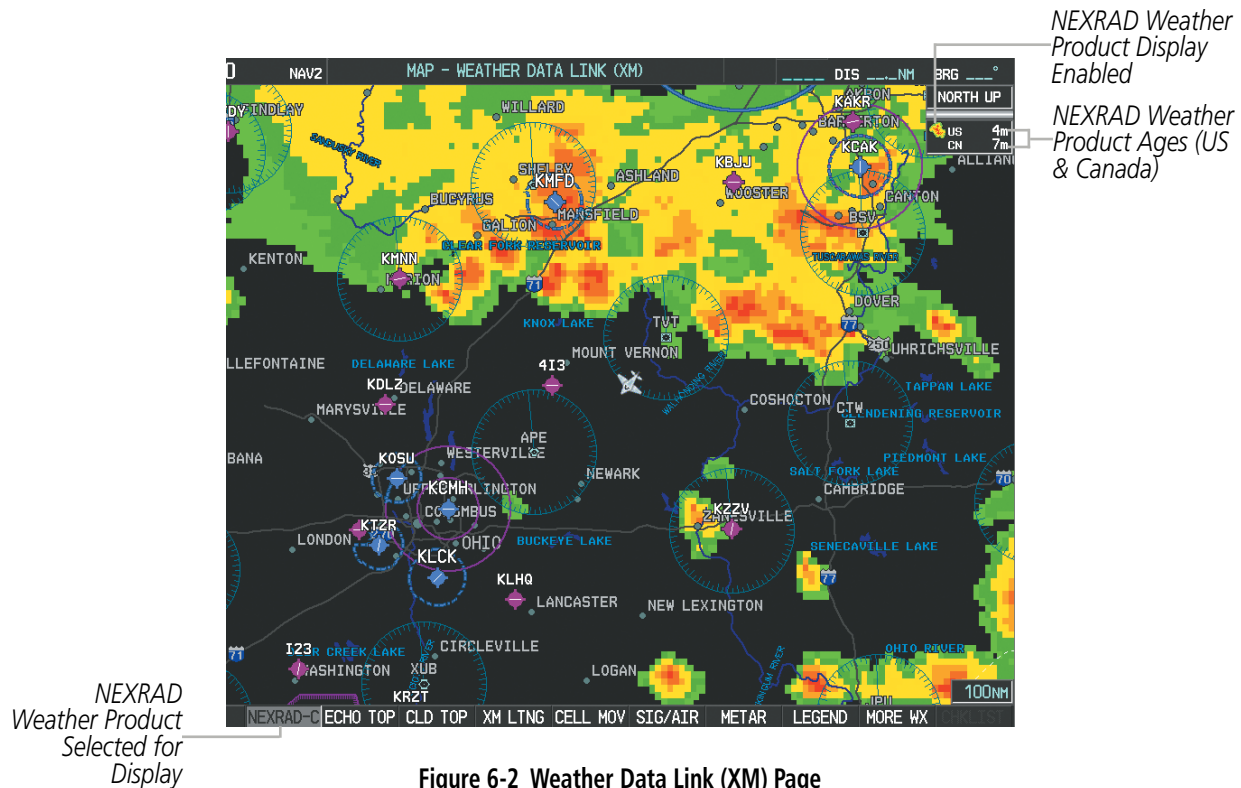

Figure 6-2 Weather Data Link (XM) Page

For each enabled SiriusXM Weather product, the system displays a weather product icon and product age. The product age is the elapsed time (in minutes) since the weather data provider compiled the weather product. The product age display does not indicate the age of the information contained within the weather product, which can be significantly older than the displayed weather product age.

The SiriusXM Weather service broadcasts weather products at specific intervals (defined in the **Broadcast Rate** column in Table 6-1). If for any reason, a product is not broadcast within the **Expiration Time** intervals (see Table 6-1), the system removes the expired data from the display, and shows dashes instead of the product age. This ensures the displayed information is consistent with what is currently being transmitted by the SiriusXM Weather service. If more than half of the expiration time has elapsed, the color of the product age changes to amber. If data for a weather product is not available (i.e., has not been received), the system displays 'N/A' next to the weather product symbol instead of the product age.

Table 6-1 shows the weather product symbols, the expiration times and the broadcast rates. The broadcast rate represents the interval at which the SiriusXM Weather service transmits new signals that may or may not contain updated weather products. It does not represent the rate at which the weather information is updated or when the Data Link Receiver receives new data. SiriusXM and its weather data suppliers define and control the data update intervals, which are subject to change.

- SYSTEM OVERVIEW
- FLIGHT INSTRUMENTS
- EIS
- AUDIO PANEL & CNS
- FLIGHT MANAGEMENT
- HAZARD AVOIDANCE
- AFCS
- ADDITIONAL FEATURES
- APPENDICES
- INDEX

SiriusXM Weather Product	Symbol	Expiration Time (Minutes)	Broadcast Rate (Minutes)
Next-generation Radar (NEXRAD)		30	5 (U.S.) 10 (Canada)
Cloud Top (CLD TOP)		60	15 (69/69A) 30 (69/69A SXM)
Echo Top (ECHO TOP)		30	7.5
SiriusXM Lightning (LTNG)		30	5
Cell Movement (CELL MOV)		30	12
SIGMETs/AIRMETs (SIG/AIR)		60	12
Meteorological Aerodrome Report (METARs)		90	12
City Forecast (CITY)		90	12
Surface Analysis (SFC)		60	12
Freezing Levels (FRZ LVL)		120	12
Winds Aloft (WIND)		90	12
County Warnings (COUNTY)		60	5
Cyclone Warnings (CYCLONE)		60	12
Icing Potential (CIP and SLD) (ICNG)		90	22
Pilot Weather Report (PIREPs)		90	12
Air Report (AIREPs)		90	12
Turbulence (TURB)		180	12
Radar Coverage (RADAR CVRG)	no product image	30	5
Temporary Flight Restrictions (TFRs)	no product image	60	12
Terminal Aerodrome Reports (TAFs)	no product image	60	12

Table 6-1 SiriusXM Weather Product Symbols and Data Timing

Table 6-2 shows which SiriusXM Weather products can be displayed (indicated with a '+' symbol) on specific maps.

SiriusXM Weather Product	PFD Inset Map	Navigation Map Page	Weather Data Link (XM) Page	Weather Information Page	AUX - Trip Planning Page	AUX - Video Page	Nearest Page Group	Flight Plan Pages
NEXRAD and No Radar Coverage	+	+	+		+	+	+	+
Cloud Top (CLD TOP)			+					
Echo Top (ECHO TOP)			+					
SiriusXM Lightning (XM LTNG)	+	+	+		+	+	+	+
Cell Movement (CELL MOV)	+	+	+		+	+	+	+
SIGMETs/AIRMETs (SIG/AIR)			+					
METARs	+	+	+	+	+	+	+	+
City Forecast (CITY)			+					
Surface Analysis (SFC)			+					
Freezing Levels (FRZ LVL)			+					
Winds Aloft (WIND)		+*	+					
County Warnings (COUNTY)			+					
Cyclone Warnings (CYCLONE)			+					
Icing Potential (ICNG)			+					
PIREPs			+	+				
AIREPs			+	+				
Turbulence (TURB)			+					
TFRs	+	+	+	+	+	+	+	+
TAFs				+				

* Winds Aloft Data displayed inside Profile View on the Navigation Map Page.

Table 6-2 SiriusXM Weather Product Display Maps

Softkeys control the display of weather information on most MFD pages and the PFD Inset Map (Figure 6-3 shows the weather product softkeys for the Weather Data Link (XM) Page). When a weather product is selected for display, the corresponding softkey label changes to gray to indicate the product is enabled.

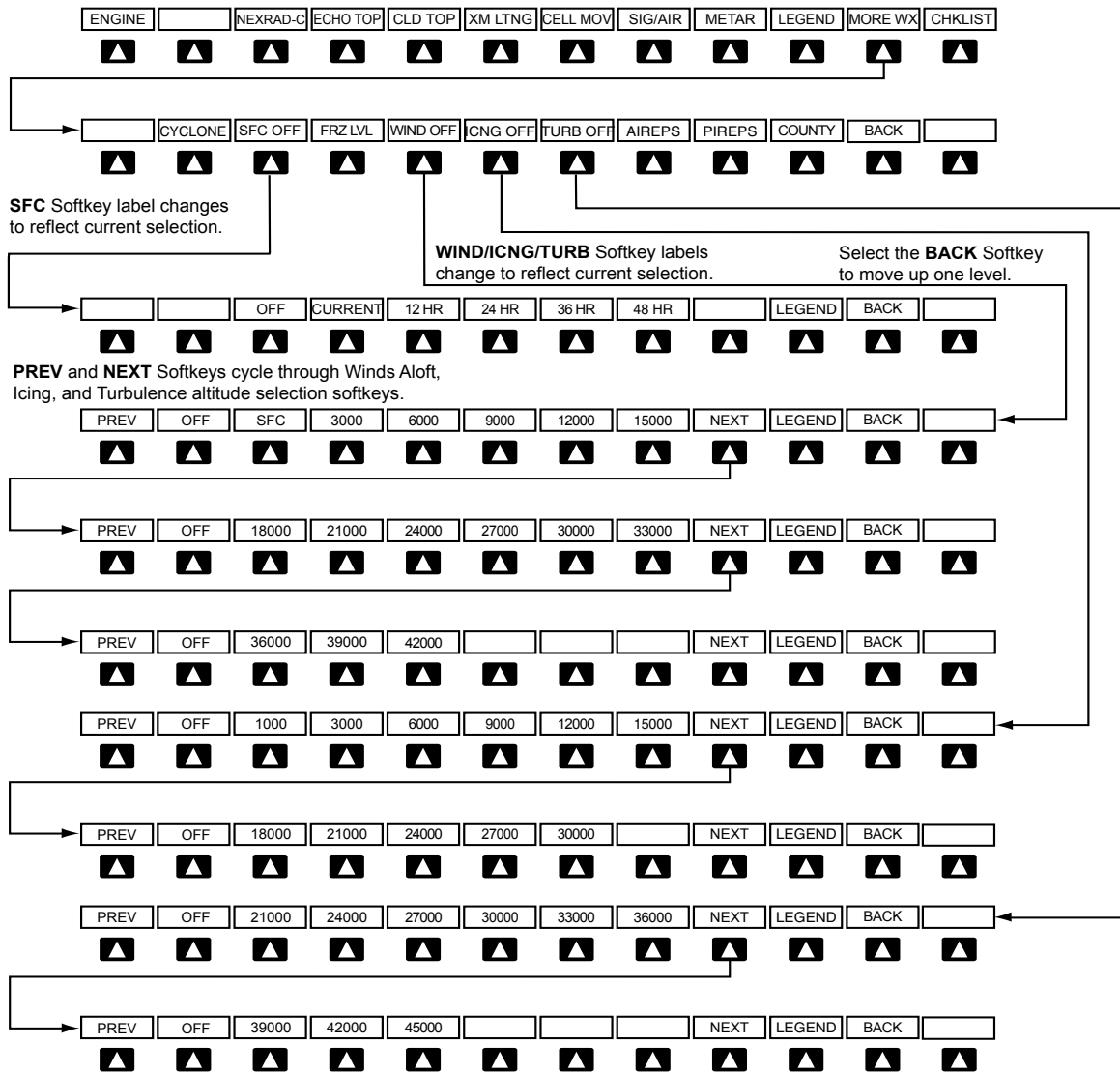

Figure 6-3 Weather Data Link (XM) Page Weather Product Softkeys

The setup menus for the Navigation Map Page and the Weather Data Link (XM) Page control the map range settings above which weather products data are decluttered from the display. If a map range larger than the weather product map range setting is selected, the weather product data is removed from the map. The menus also provide a means in addition to the softkeys for enabling/disabling display of weather products.

Setting up and customizing the Weather Data Link (XM) Page:

- 1) Select the Weather Data Link (XM) Page.
- 2) Press the **MENU** Key.
- 3) With 'Weather Setup' highlighted, press the **ENT** Key (Figure 6-4).
- 4) Turn the small **FMS** Knob to select 'PRODUCT GROUP 1' or 'PRODUCT GROUP 2', and press the **ENT** Key (Figure 6-5).
- 5) Turn the large **FMS** Knob or press the **ENT** Key to scroll through product selections.
- 6) Turn the small **FMS** Knob to scroll through options for each product (ON/OFF, range settings, etc.).
- 7) Press the **ENT** Key to select an option.
- 8) Push the **FMS** Knob or **CLR** Key to return to the Weather Data Link (XM) Page with the changed settings.



Figure 6-4 Weather Data Link (XM) Page Menu

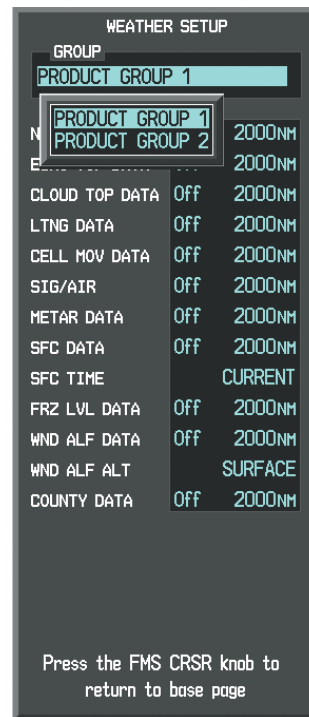

Figure 6-5 Weather Data Link (XM) Page Setup Menu

Restoring default Weather Data Link (XM) Page settings:

- 1) Select the Weather Data Link (XM) Page.
- 2) Press the **MENU** Key.
- 3) With 'Weather Setup' highlighted, press the **ENT** Key.
- 4) Press the **MENU** Key.
- 5) Highlight the desired default(s) to restore (all or for selection) and press **ENT** Key.

Maps besides the Weather Data Link (XM) Page use settings based on those selected for the Navigation Map Page.

Setting up and customizing weather data for the Navigation Map Page:

- 1) Select the Navigation Map Page.
- 2) Press the **MENU** Key.
- 3) With 'Map Setup' highlighted, press the **ENT** Key (Figure 6-6).
- 4) Turn the small **FMS** Knob to select the 'Weather' Group and press the **ENT** Key (Figure 6-7).
- 5) Turn the large **FMS** Knob or press the **ENT** Key to scroll through product selections (Figure 6-8).
- 6) Turn the small **FMS** Knob to scroll through options for each product (ON/OFF, range settings).
- 7) Press the **ENT** Key to select an option.
- 8) Push the **FMS** Knob or **CLR** Key to return to the Navigation Map Page with the changed settings.



Figure 6-6 Navigation Map Page Menu



Figure 6-7 Navigation Map Page Setup Menu

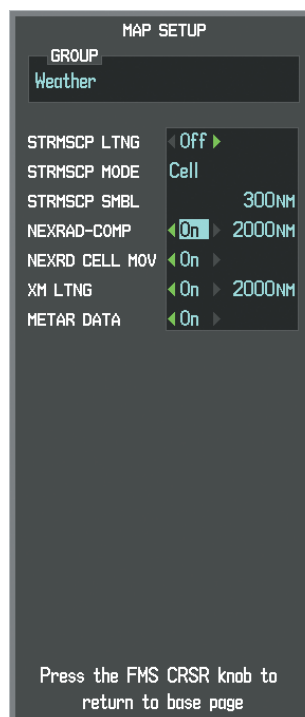

Figure 6-8 Navigation Map Page Setup Menu, Weather Group

When a SiriusXM Weather product is enabled for display on the PFD Inset Map, the weather product information box (with the product icon and age) can be displayed inside the PFD Inset Map.

Displaying/removing the weather product information box on the PFD Inset Map:

- 1) On the PFD, press the **INSET** Softkey.
- 2) Press the **WX LGND** Softkey.
- 3) To remove the weather product information box, press the **WX LGND** Softkey again.

Each active weather product has an associated legend which can be displayed on the Weather Data Link (XM) Page. A weather product legend can also be displayed on the Navigation Map Page for active SiriusXM Weather products displayed on that page.

Viewing legends for displayed weather products (on the Weather Data Link (XM) Page):

- 1) Select the Weather Data Link (XM) Page.
- 2) Press the **LEGEND** Softkey to display the legends for the displayed weather products.
 - Or:
 - a) Press the **MENU** Key.
 - b) Select 'Weather Legend' and press the **ENT** Key.
- 3) Turn the **FMS** Knob to scroll through the legends if more are available than fit in the window.
- 4) To remove the Legend Window, press the **LEGEND** Softkey, the **ENT** or the **CLR** Key, or push the **FMS** Knob.

Viewing legends for displayed weather products (on the Navigation Map Page):

- 1) Select the Navigation Map Page.
- 2) Press the **MAP** Softkey.
- 3) Press the **LEGEND** Softkey (available if one or more XM weather products are enabled for display).
- 4) To remove the Legend Window, press the **LEGEND** Softkey, the **ENT** or the **CLR** Key, or push the **FMS** Knob.

Additional information about the following can be displayed by panning over the display on the map:

- | | |
|-----------------|-------------------|
| • Echo Tops | • METARs |
| • Cloud Tops | • County Warnings |
| • Cell Movement | • TFRs |
| • SIGMETs | • AIREPs |
| • AIRMETs | • PIREPs |

The map panning feature is enabled by pushing the **Joystick**. The map range is adjusted by turning the **Joystick**. If the map range is adjusted while panning is enabled, the map is re-centered on the Map Pointer.

- SYSTEM OVERVIEW
- FLIGHT INSTRUMENTS
- EIS
- AUDIO PANEL & CNS
- FLIGHT MANAGEMENT
- HAZARD AVOIDANCE
- AFCS
- ADDITIONAL FEATURES
- APPENDICES
- INDEX

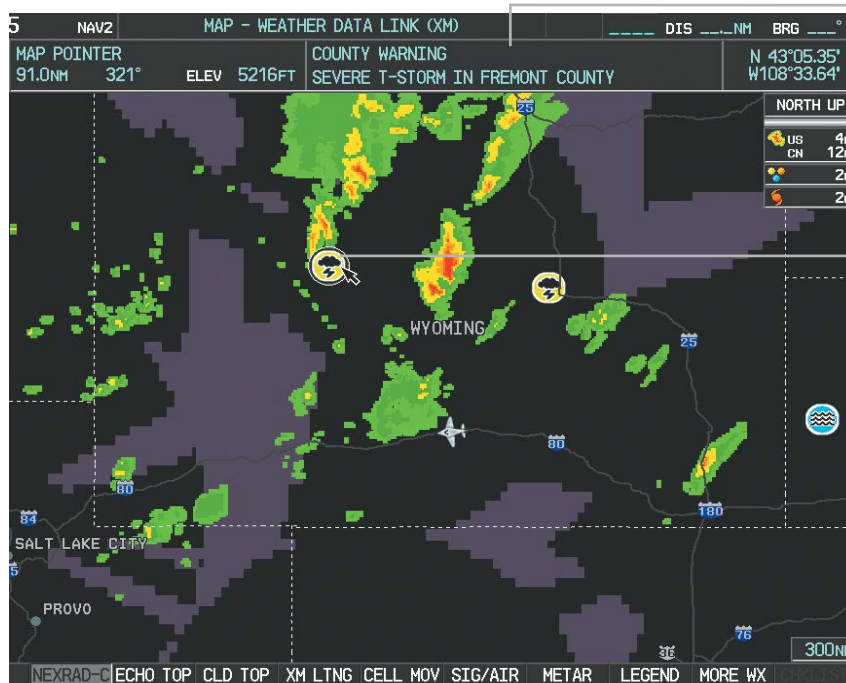

Additional Information on Weather Feature Selected with Map Pointer

Severe Thunderstorm Warning Selected with Map Pointer

Figure 6-9 Panning on the Weather Data Link (XM) Page

NEXRAD



NOTE: The NEXRAD weather product cannot be displayed at the same time as terrain, echo tops, turbulence, icing data is displayed.

The National Weather Service (NWS) operates the WSR-88D, or NEXRAD (NEXt-generation RADar) system, an extensive network of 156 high-resolution Doppler radar systems. The NEXRAD network provides centralized meteorological information for the continental United States and selected overseas locations. The maximum range of a single NEXRAD site is 250 nm. In addition to a wide array of services, the NEXRAD network provides important information about severe weather and air traffic safety.

Individual NEXRAD sites supply the network with radar images, and the images from each radar site may arrive at the network at different rates and times. Periodically, the weather data provider compiles the available individual site images from the network to form a composite image, and assigns a single time to indicate when it created the image. This image becomes the NEXRAD weather product. Individual images--gathered from each NEXRAD site--differ in age, and are always older than the displayed NEXRAD weather product age. The data provider then sends the NEXRAD data to the SiriusXM Weather service, whose satellites transmit this information during the next designated refresh time for the NEXRAD weather product.

Because of the time required to detect, assemble, and distribute the NEXRAD weather product, the displayed weather information contained within the product may be significantly older than the current radar synopsis and may not depict the current weather conditions. The NEXRAD weather product should never be used as a basis for maneuvering in, near, or around areas of hazardous weather regardless of the information it contains.

The composite reflectivity NEXRAD weather product shows the *highest* radar energy received from multiple antenna tilt angles. The display of the information is color-coded to indicate the intensity of the echoes and the type of precipitation.

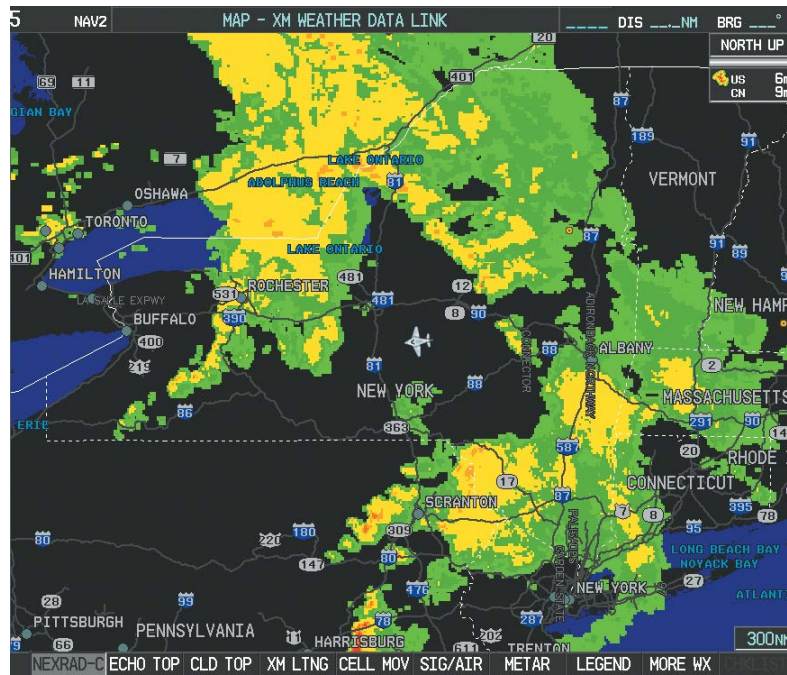

Figure 6-10 NEXRAD Data on the Weather Data Link (XM) Page

Displaying NEXRAD weather information:

- 1) Press the **MAP** Softkey (for the PFD Inset Map, press the **INSET** Softkey). This step is not necessary on the Weather Data Link (XM) Page.
- 2) Press the **NEXRAD-C** Softkey.

A mosaic of data from all the available NEXRAD radar sites is shown. This data is composed of the maximum reflectivity from the individual radar sweeps. The display of the information is color-coded to indicate the weather severity level. All weather product legends can be viewed on the Weather Data Link (XM) Page. For the NEXRAD legend (Figure 6-11), press the **LEGEND** Softkey when NEXRAD is selected for display.

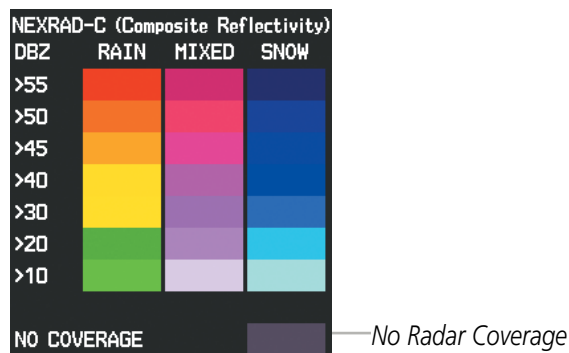

Figure 6-11 NEXRAD Composite Reflectivity Legend

The display of No Radar Coverage is always active when either NEXRAD or ECHO TOPS is selected. Areas where NEXRAD radar coverage and Echo Tops information is not currently available or is not being collected are indicated in a gray shade of purple.

REFLECTIVITY

Reflectivity is the amount of transmitted power returned to the radar receiver. Colors on the NEXRAD display are directly correlative to the level of detected reflectivity. Reflectivity as it relates to hazardous weather can be very complex.

The role of radar is essentially to detect moisture in the atmosphere. Simply put, certain types of weather reflect radar better than others. The intensity of a radar reflection is not necessarily an indication of the weather hazard level. For instance, wet hail returns a strong radar reflection, while dry hail does not. Both wet and dry hail can be extremely hazardous.

The different NEXRAD echo intensities are measured in decibels (dB) relative to reflectivity (Z). NEXRAD measures the radar reflectivity ratio, or the energy reflected *back to* the radar receiver (designated by the letter Z). The value of Z increases as the returned signal strength increases.

NEXRAD LIMITATIONS

NEXRAD radar images may have certain limitations:

- Undetermined precipitation types may be displayed as mixed.
- An individual NEXRAD site cannot depict high altitude storms at close ranges. It has no information about storms directly over the site.
- Precipitation may be occurring below the lowest antenna tilt angle (0.5°), and therefore the radar beam overshoots the precipitation. For example, at a distance of 124 miles from the radar site, the radar beam is approximately 18,000 feet above the radar site. The radar cannot detect any precipitation occurring below the beam at this distance and altitude.
- When zoomed in to a range of 30 nm, each square block on the display represents an area of four square kilometers. The intensity level reflected by each square represents the *highest* level of NEXRAD data sampled within the area (Figure 6-12).
- Unknown precipitation below 52°N is displayed as rain regardless of actual precipitation type.

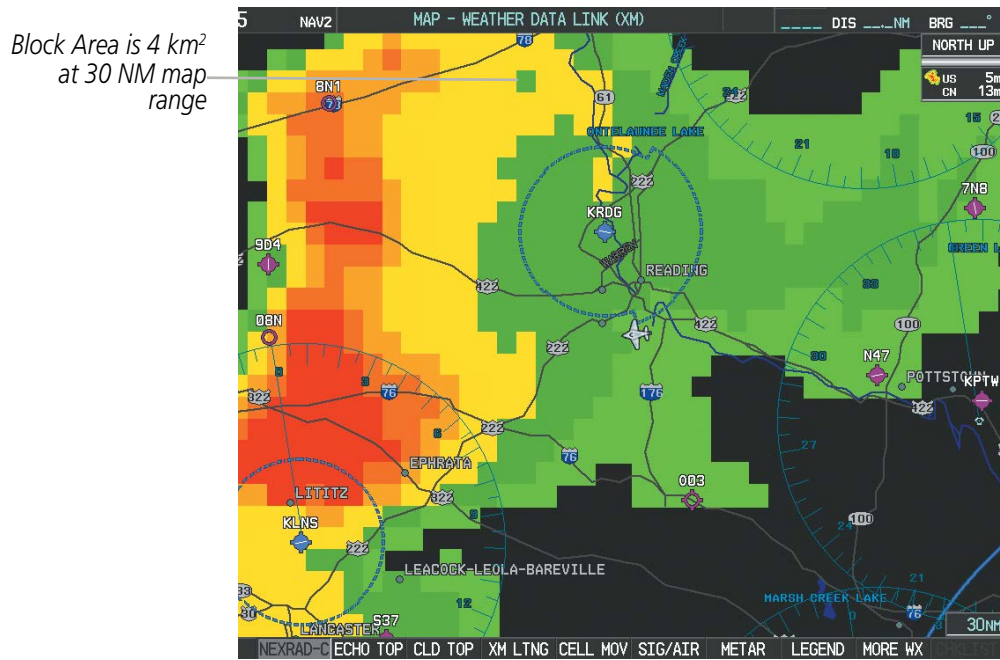

Figure 6-12 NEXRAD Weather Product with 30 NM Map Range

The following may cause abnormalities in displayed NEXRAD radar images:

- Ground clutter
- Strokes and spurious radar data
- Sun strokes (when the radar antenna points directly at the sun)
- Interference from buildings or mountains, which may cause shadows
- Metallic dust (chaff) from military aircraft, which can cause alterations in radar scans

NEXRAD LIMITATIONS (CANADA)

- Radar coverage extends to 55°N.
- Any precipitation displayed between 52°N and 55°N is displayed as mixed regardless of actual precipitation type.

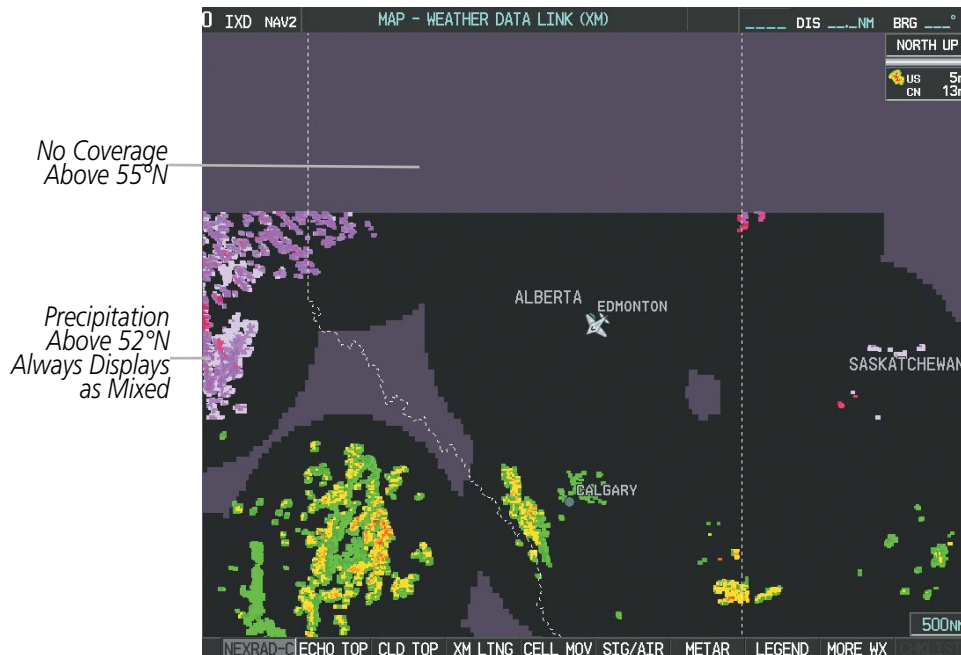

Figure 6-13 NEXRAD Weather Product - Canada

ECHO TOPS



NOTE: Echo tops cannot be displayed at the same time as NEXRAD or Cloud Tops are selected for display.

The Echo Tops weather product (Figure 6-14) shows the location, elevation, and direction of the highest radar echo. The highest radar echo does not indicate the top of a storm or clouds; rather it indicates the highest altitude at which precipitation is detected. Information is derived from NEXRAD data.

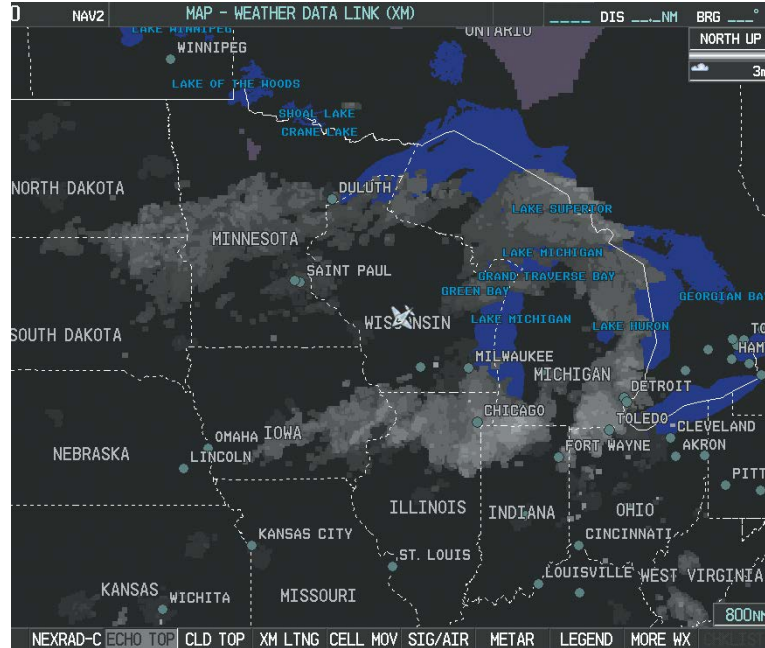

Figure 6-14 Echo Tops Weather Product

Displaying Echo Tops information:

- 1) Select the Weather Data Link (XM) Page.
- 2) Press the **ECHO TOP** Softkey.

To display the Echo Tops legend (Figure 6-15), press the **LEGEND** Softkey when Echo Tops is selected for display. Since Echo Tops and Cloud Tops use the same color scaling to represent altitude, display of these weather products is mutually exclusive. When Echo Tops is activated, NEXRAD and Cloud Tops data are removed.

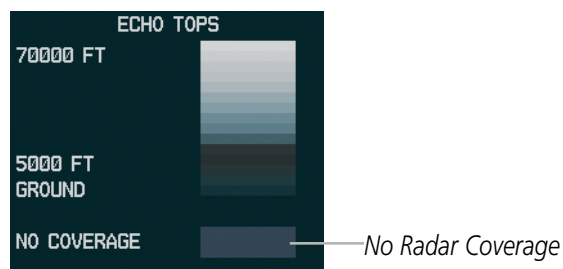

Figure 6-15 Echo Tops Legend

The display of No Radar Coverage is always active when either NEXRAD or Echo Tops is selected. Areas where NEXRAD radar coverage and Echo Tops information is not currently available or is not being collected are indicated in gray shade of-purple.

CLOUD TOPS



NOTE: *Cloud Tops and Echo Tops cannot be displayed at the same time.*

The Cloud Tops weather product (Figure 6-16) depicts cloud top altitudes as determined from satellite imagery.



NOTE: *If a GDL 69/69A SXM receiver is installed, the broadcast rate for Cloud Tops is 30 minutes. As with all SiriusXM Weather products, the product age becomes amber when it reaches half of the expiration time, which is 60 minutes for Cloud Tops. Therefore, this weather product age may be amber during routine operation.*

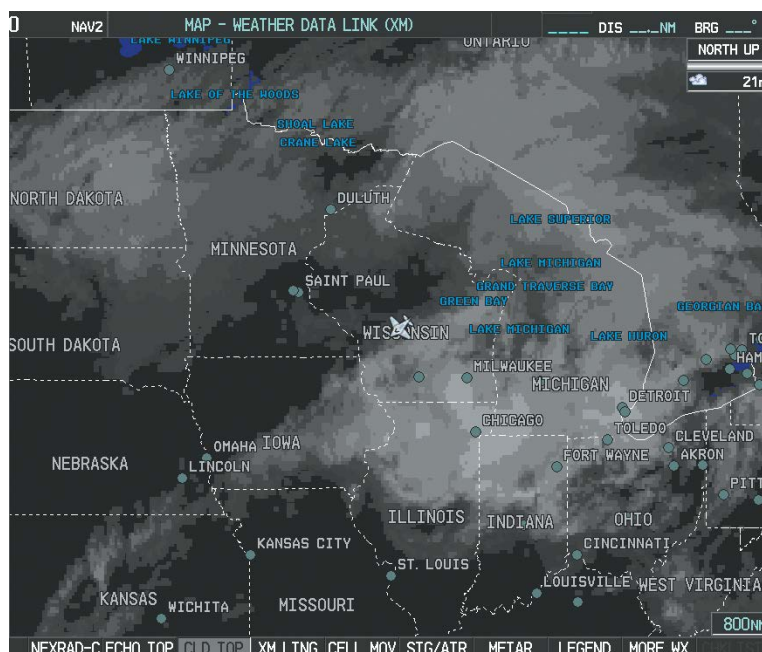

Figure 6-16 Cloud Tops Weather Product

Displaying Cloud Tops information:

- 1) Select the Weather Data Link (XM) Page.
- 2) Press the **CLD TOP** Softkey.

To display the Cloud Tops legend (Figure 6-17), press the **LEGEND** Softkey when Cloud Tops is selected for display. Since Cloud Tops and Echo Tops use the same color scaling to represent altitude, display of these weather products is mutually exclusive. When Cloud Tops is activated, Echo Tops data is removed.

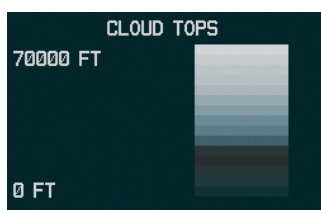

Figure 6-17 Cloud Tops Legend

SIRIUSXM LIGHTNING



NOTE: The SiriusXM Lightning weather product cannot be displayed at the same time as another lightning data link source (such as optional Stormscope) is selected for display.

The SiriusXM Lightning weather product (Figure 6-18) shows the approximate location of cloud-to-ground lightning strikes. A strike icon represents a strike that has occurred within a two-kilometer region. The exact location of the lightning strike is not displayed.

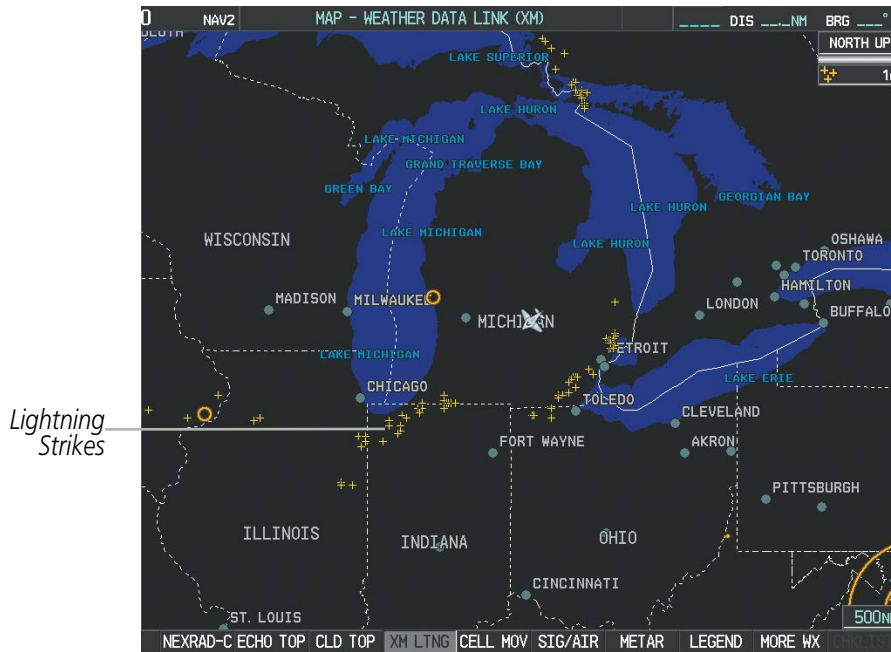

Figure 6-18 SiriusXM Lightning Weather Product

Displaying XM Lightning information:

- 1) Press the **MAP** Softkey (for the PFD Inset Map, press the **INSET** Softkey). This step is not necessary on the Weather Data Link (XM) Page.
- 2) Press the **XM LTNG** Softkey (**LTNG** Softkey on the Weather Data Link (XM) Page).

To display the XM Lightning legend on the Weather Data Link (XM) Page (Figure 6-19), press the **LEGEND** Softkey when XM Lightning is selected for display.

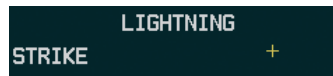

Figure 6-19 XM Lightning Legend

CELL MOVEMENT

The Cell Movement weather product (Figure 6-20) shows the location and movement of storm cells as identified by the ground-based system. Cells are represented by yellow squares, with direction of movement indicated with short, orange arrows.

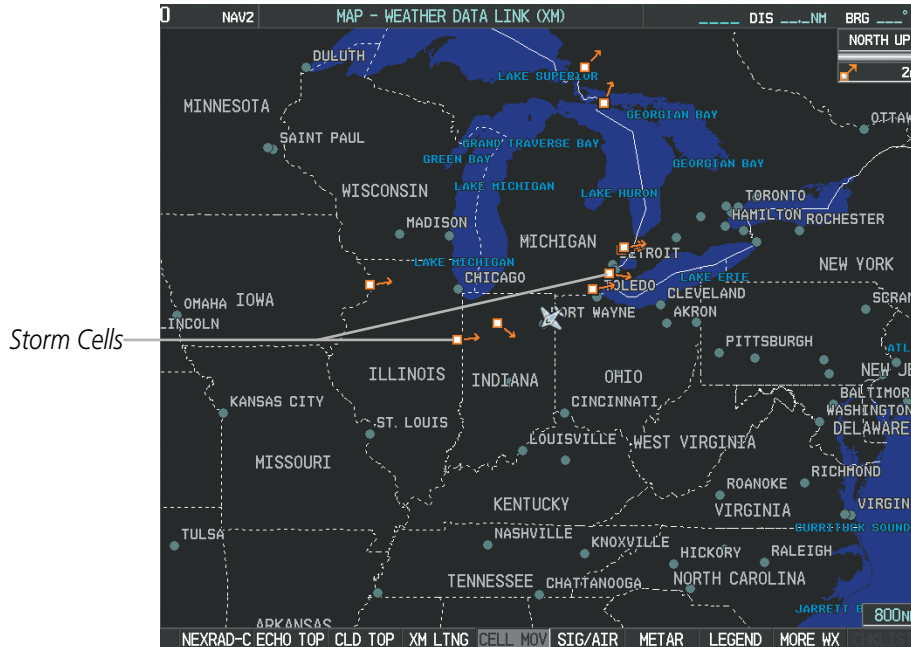

Figure 6-20 Cell Movement Data



NOTE: The Storm Cell base height is not available if a GDL 69A SXM data link receiver is installed. In this case, the Storm Cell base height is displayed as 0 feet when the map pointer selects a storm cell.

On most applicable maps, the Cell Movement weather product is selected for display along with NEXRAD. On the Weather Data Link (XM) Page, Cell Movement can be selected independently.

Displaying Cell Movement information:

- 1) Press the **MAP** Softkey (for the PFD Inset Map, select the **INSET** Softkey). This step is not necessary on the Weather Data Link (XM) Page.
- 2) Press the **NEXRAD** Softkey (**CEL MOV** Softkey on the Weather Data Link (XM) Page). For Cell Movement to be displayed on maps other than the Weather Data Link (XM) Page, Cell Movement must be turned on in the Navigation Map Setup Menu (see "Setting Up SiriusXM Weather").

To display the Cell Movement legend on the Weather Data Link (XM) Page, (Figure 6-21), press the **LEGEND** Softkey when Cell Movement is selected for display.

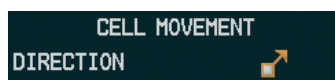

Figure 6-21 Cell Movement Legend

SIGMETS AND AIRMETS

SIGMETs (SIGnificant METeorological Information) and AIRMETS (AIRmen's METeorological Information) are broadcast for potentially hazardous weather. A Convective SIGMET is issued for hazardous convective weather. A localized SIGMET is a significant weather condition occurring at a localized geographical position.

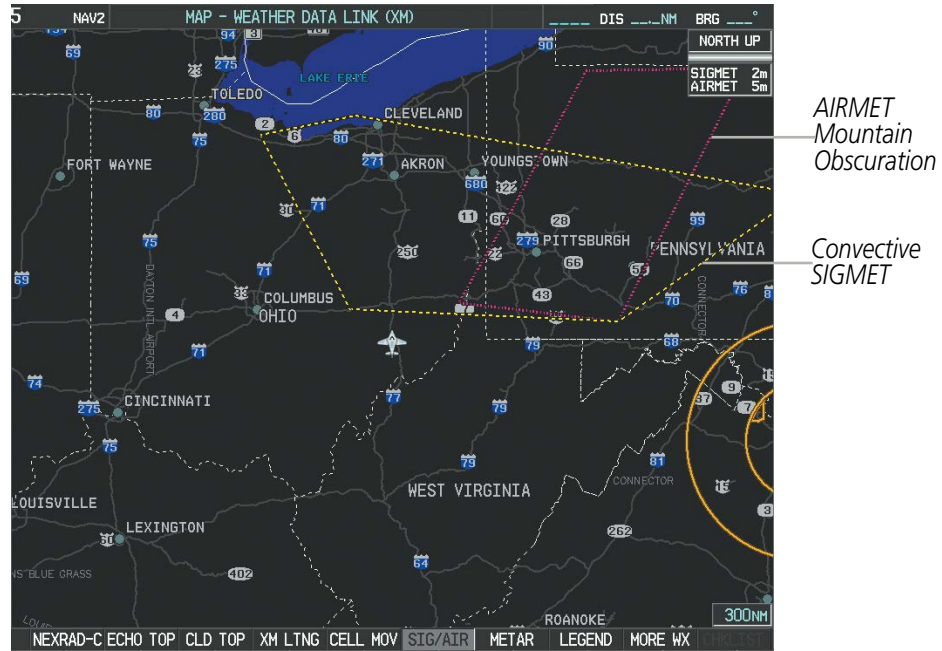

Figure 6-22 SIGMET/AIRMET Data

Displaying SIGMETs and AIRMETS:

- 1) Select the Weather Data Link (XM) Page.
- 2) Press the **SIG/AIR** Softkey.
- 3) To view the text of the SIGMET or AIRMET, press the **Joystick** and move the Map Pointer over the icon.
- 4) Press the **ENT** key. Figure 6-23 shows sample SIGMET text.

To display the SIGMET and AIRMET legend (Figure 6-24), press the **LEGEND** Softkey when SIGMETs and AIRMETS are selected for display.

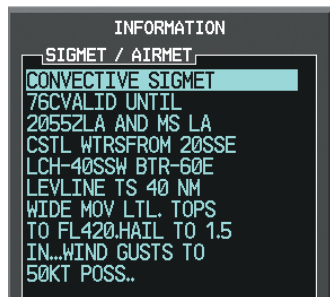

Figure 6-23 Sample SIGMET Text



Figure 6-24 SIGMET/AIRMET Legend

Displaying METAR and TAF text:

- 1) On the Weather Data Link (XM) Page, press the **METAR** Softkey.
- 2) Push the **Joystick** and pan to the desired airport.
- 3) Press the **ENT** Key. The Weather Information Page is shown with METAR and TAF text.
- 4) Use the **FMS** Knob or the **ENT** Key to scroll through the METAR and TAF text. METAR text must be completely scrolled through before scrolling through the TAF text.
- 5) Push the **FMS** Knob or the **CLR** Key to return to the Weather Data Link (XM) Page.

Or:

- 1) Select the Weather Information Page.
 - a) Turn the large **FMS** Knob to select the Waypoint Page Group.
 - b) Press the **WX** Softkey to select the Weather Information Page.
- 2) Push the **FMS** Knob to display the cursor.
- 3) Use the **FMS** Knob to enter the desired airport and press the **ENT** Key.
- 4) Use the **FMS** Knob or the **ENT** Key to scroll through the METAR and TAF text. Note that the METAR text must be completely scrolled through before scrolling through the TAF text.

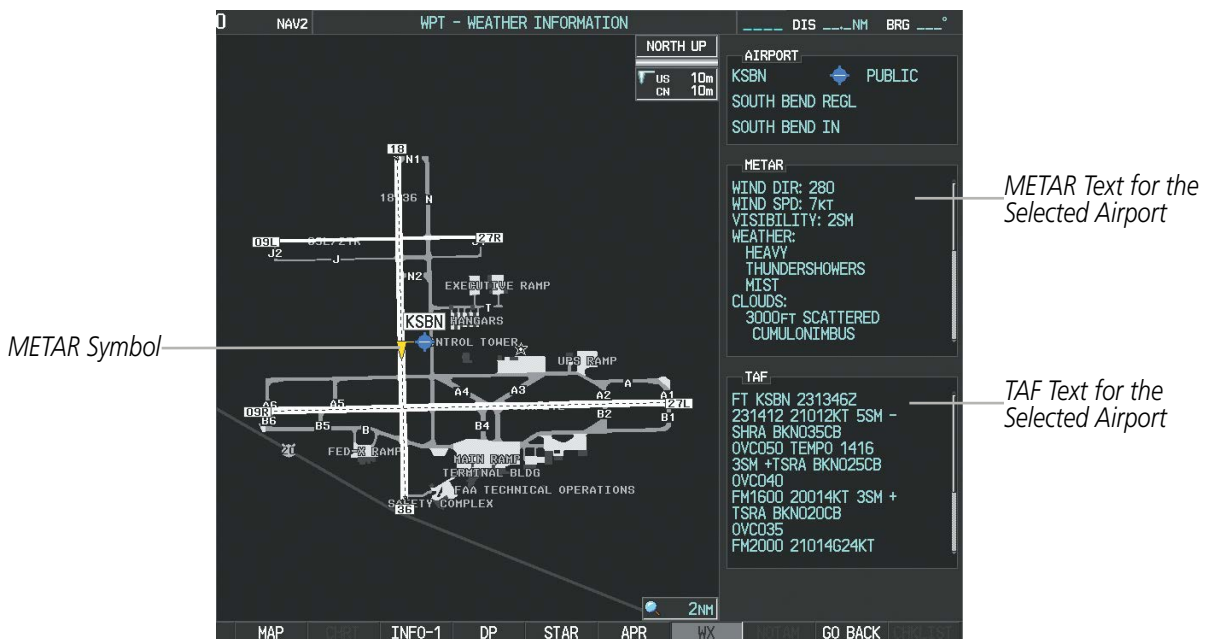

Figure 6-26 METAR and TAF Text on the Weather Information Page

Original METAR text is also accessible while panning the map cursor over a METAR flag on any map page on which a METAR is displayed. The METAR text is shown in a box near the METAR flag.

In addition, METAR flags and their associated text are displayed on the Active Flight Plan Page on the MFD. METAR flags appear next to waypoints in the flight plan with an associated METAR. A solid METAR flag indicates the METAR observations are available for a specific waypoint; a hollow METAR flag indicates an off-route METAR near the waypoint is available.

Displaying original METAR text on the Active Flight Plan Page:

- 1) Select the Active Flight Plan Page on the MFD.
- 2) Push the **FMS** Knob to activate the cursor.
- 3) Turn the large **FMS** Knob to highlight the desired waypoint. The METAR text will appear in the 'SELECTED WAYPOINT WEATHER' window below.
- 4) When finished, push the **FMS** Knob to remove the cursor or press the **FPL** Key to exit the Active Flight Plan Page.

To display the METAR legend on the Weather Data Link (XM) Page (Figure 6-27), press the **LEGEND** Softkey when METARs are selected for display.

The METAR flag color is determined by the information in the METAR text. A gray METAR flag is displayed when the METAR text does not contain adequate information.



Figure 6-27 METAR Legend

SURFACE ANALYSIS AND CITY FORECAST



NOTE: Surface Analysis and City Forecast data are displayed only within the installed Aviation Database service area.

Surface Analysis and City Forecast information is available for current and forecast weather conditions. Forecasts are available for intervals of 12, 24, 36, and 48 hours.

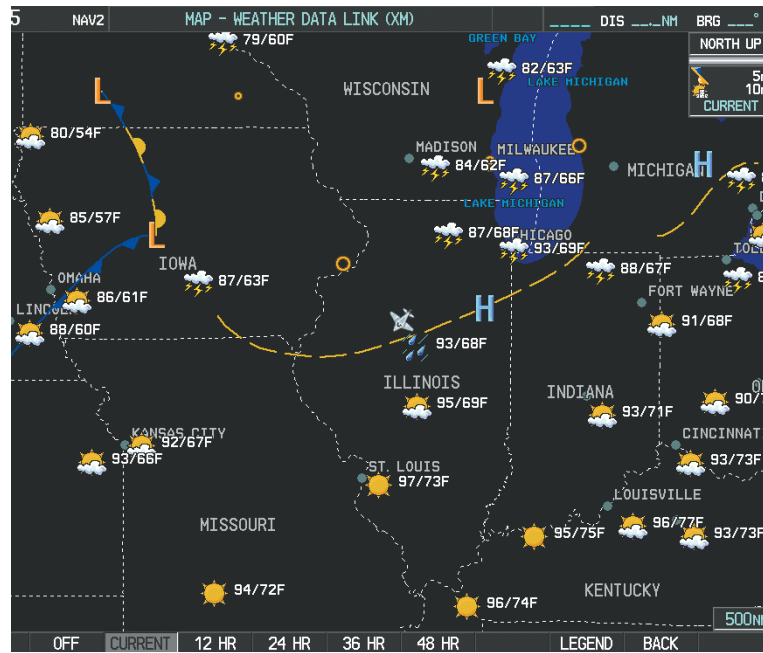

Figure 6-28 Current Surface Analysis Data

Displaying Surface Analysis and City Forecast information:

- 1) Select the Weather Data Link (XM) Page.
- 2) Press the **MORE WX** Softkey.
- 3) Press the **SFC** Softkey.
- 4) Select the desired forecast time: **CURRENT**, **12 HR**, **24 HR**, **36 HR**, or **48 HR**. The **SFC** Softkey label changes to reflect the forecast time selected.

To display the Surface Analysis and City Forecast legend (Figure 6-29), press the **LEGEND** Softkey when Surface Analysis and City Forecast are selected to be displayed.

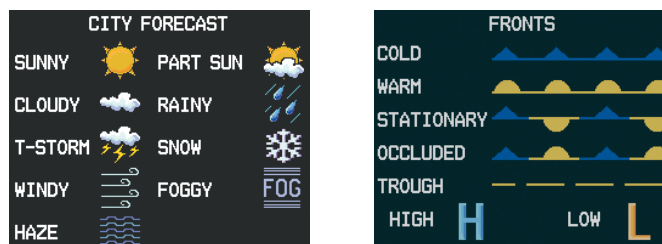

Figure 6-29 Surface Analysis Legend

FREEZING LEVELS

Freezing Level data shows the color-coded contour lines for the altitude and location at which the first isotherm is found (Figure 6-30). When no data is displayed for a given altitude, the data for that altitude has not been received, or is out of date and has been removed from the display. New data appears at the next update.

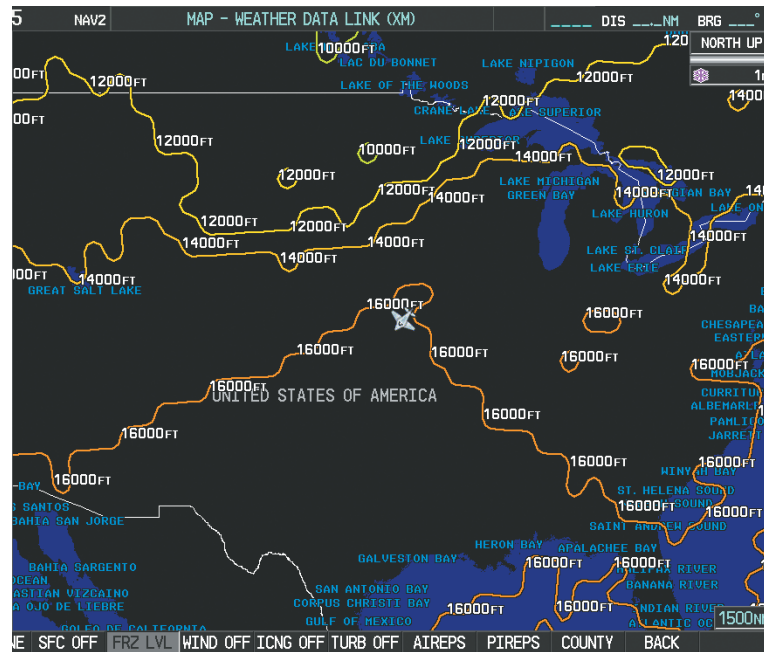

Figure 6-30 Freezing Level Data

Displaying Freezing Level information:

- 1) Select the Weather Data Link (XM) Page.
- 2) Press the **MORE WX** Softkey.
- 3) Press the **FRZ LVL** Softkey.

To display the Freezing Level legend (Figure 6-31), press the **LEGEND** Softkey when Freezing Level data is selected to be displayed.



Figure 6-31 Freezing Level Legend

WINDS ALOFT

Winds Aloft data (Figure 6-32) shows the predicted wind speed and direction at the surface and at selected altitudes. Altitude can be displayed in 3,000-foot increments up to 42,000 feet MSL.

Displaying Winds Aloft data:

- 1) Select the Weather Data Link (XM) Page.
- 2) Press the **MORE WX** Softkey.
- 3) Press the **WIND** Softkey.
- 4) Select the desired altitude level: SFC (surface) up to 42,000 feet. Press the **NEXT** or **PREV** Softkey to cycle through the altitude softkeys. The **WIND** Softkey label changes to reflect the altitude selected.

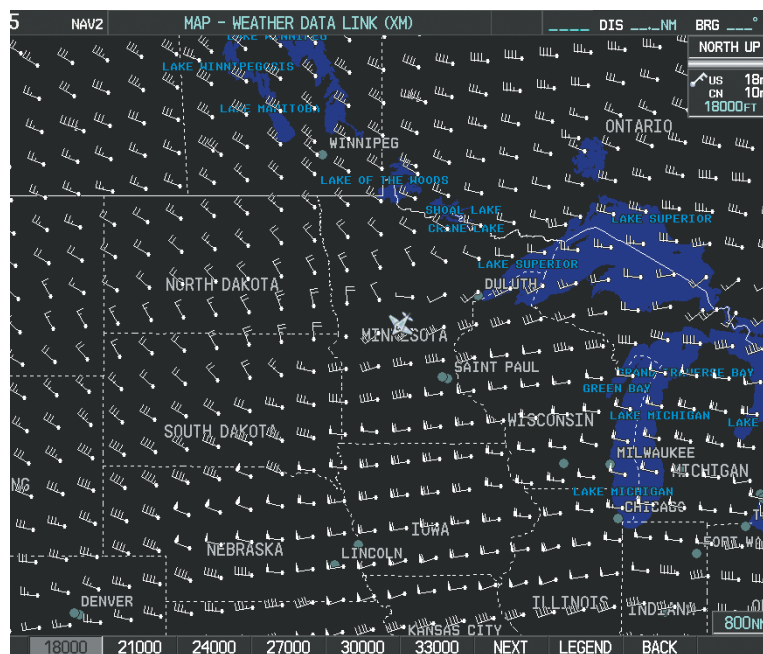

Figure 6-32 Winds Aloft Data at 12,000 Feet

To display the Winds Aloft legend (Figure 6-33), press the **LEGEND** Softkey when Winds Aloft is selected for display.

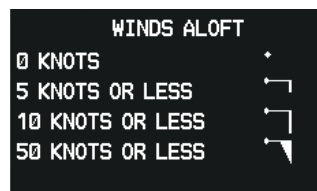

Figure 6-33 Winds Aloft Data with Legend

Headwind and tailwind components aloft are available inside the Profile View on the Navigation Map Page (Figure 6-34). The displayed components are relative to current aircraft altitude and track, but not to aircraft speed.

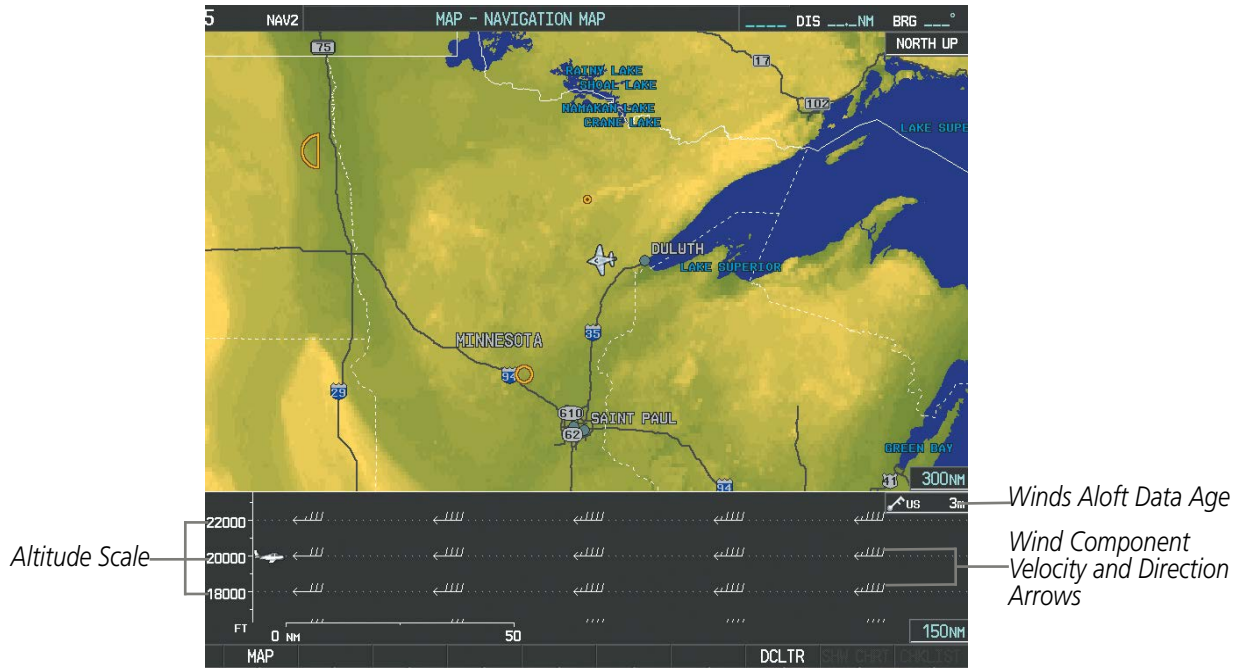

Figure 6-34 Navigation Map Page with Winds Aloft Data on Profile View

Arrows pointing to the left indicate headwind components; tailwind component arrows point to the right, as shown in Table 6-3.

Headwind Symbol	Tailwind Symbol	Headwind/Tailwind Component
None	None	Less than 5 knots
		5 knots
		10 knots
		50 knots

Table 6-3 Profile View Headwind/Tailwind Component Symbols

Showing/Hiding Profile View (containing winds aloft data)

- 1) Select the Navigation Map Page.
- 2) Press the **MAP** Softkey.
- 3) Press the **PROFILE** Softkey.

Or:

- 1) Select the Navigation Map Page
- 2) Press the **MENU** Key.
- 3) Turn the large FMS Knob to highlight 'Show Profile View' or 'Hide Profile View' (choice dependent on current state) and press the **ENT** Key.

Winds Aloft information inside the Profile View is enabled by default when the Profile View is displayed on the Navigation Map Page. This behavior can be changed on the Navigation Map Page.

Enabling/disabling winds aloft data display in Profile View:

- 1) Select the Navigation Map Page.
- 2) Press the **MENU** Key.
- 3) With Map Setup highlighted, press the **ENT** Key (Figure 6-35).
- 4) Turn the small **FMS** Knob to select the Profile Group and press the **ENT** Key (Figure 6-36).
- 5) Turn the large **FMS** Knob to select 'Profile Winds' (Figure 6-37).
- 6) Turn the small **FMS** Knob to select 'On' or 'Off'.
- 7) Push the **FMS** Knob or **CLR** Key to return to the Navigation Map Page with the changed settings.

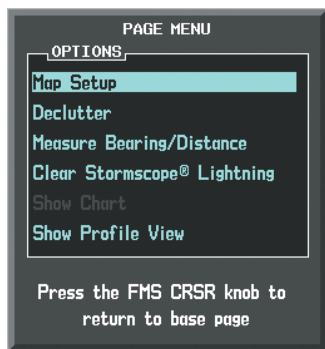

Figure 6-35 Navigation Map Page Menu

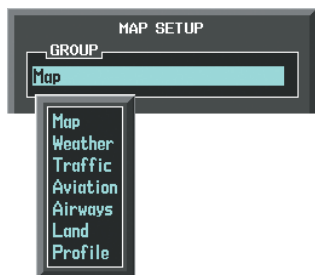

Figure 6-36 Navigation Map Page Setup Menu



Figure 6-37 Navigation Map Page Setup Menu, Weather Group

COUNTY WARNINGS

The County weather product (Figure 6-38) provides specific public awareness and protection weather warnings from the National Weather Service (NWS) for severe thunderstorms, tornadoes, and flood conditions.

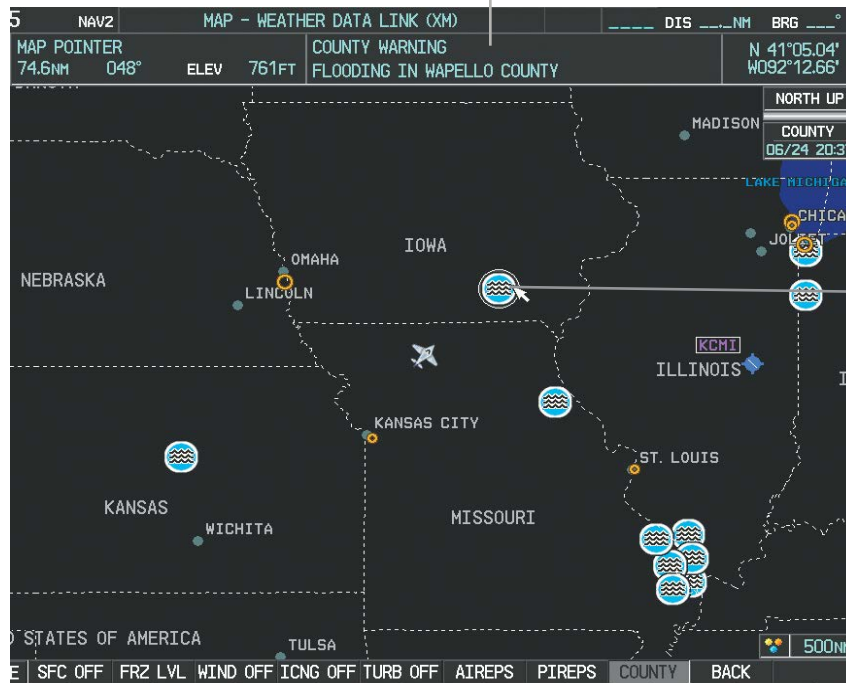

Additional Information on Flood Warning Selected with Map Pointer

Flood Warning

Figure 6-38 County Flood Warning

Displaying County Warning information:

- 1) Select the Weather Data Link (XM) Page.
- 2) Press the **MORE WX** Softkey.
- 3) Press the **COUNTY** Softkey.

To display the County Warnings legend (Figure 6-39), press the **LEGEND** Softkey when County Warnings are selected to be displayed.

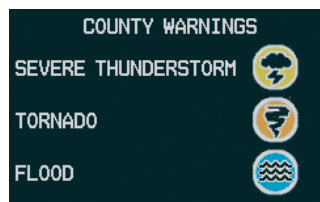

Figure 6-39 County Warnings Legend

CYCLONE

The Cyclone weather product (Figure 6-40) shows the current location of cyclones (hurricanes) and tropical storms using the symbol shown below (Figure 6-41). Storm tracks include the predicted date and time of arrival inside orange boxes.



Figure 6-40 Cyclone Data Selected for Display

Displaying cyclone (hurricane) track information:

- 1) Select the Weather Data Link (XM) Page.
- 2) Press the **MORE WX** Softkey.
- 3) Press the **CYCLONE** Softkey.

To display the Cyclone legend (Figure 6-41), press the **LEGEND** Softkey when the Cyclone weather product is enabled.

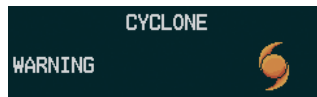

Figure 6-41 Cyclone Legend

ICING (CIP & SLD)



NOTE: Icing data cannot be displayed at the same time as NEXRAD data is displayed.

Current Icing Product (CIP) data shows a graphical view of the current icing environment (Figure 6-42). Icing severity is displayed in four categories: light, moderate, severe, and extreme (not specific to aircraft type). The CIP product is not a forecast, but a presentation of the current conditions at the time of the analysis.

Supercooled Large Droplet (SLD) icing conditions are characterized by the presence of relatively large, super cooled water droplets indicative of freezing drizzle and freezing rain aloft. SLD threat areas are depicted as magenta dots over the CIP colors.

Displaying Icing data:

- 1) Select the Weather Data Link (XM) Page.
- 2) Press the **MORE WX** Softkey.
- 3) Press the **ICNG** Softkey.
- 4) Select the desired altitude level: 1,000 feet up to 30,000 feet. Press the **NEXT** or **PREV** Softkey to cycle through the altitude softkeys. The **ICNG** Softkey label changes to reflect the altitude selected.

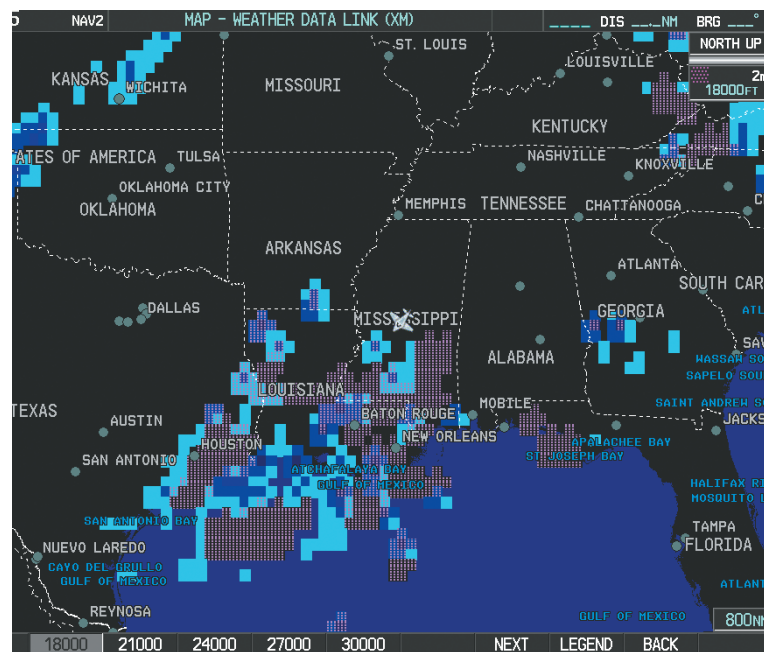

Figure 6-42 Icing Data at 18,000 Feet

To display the Icing Potential legend (Figure 6-43), press the **LEGEND** Softkey when Icing is selected for display.

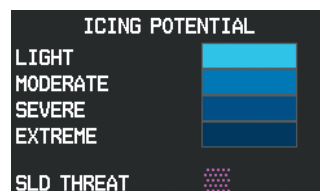

Figure 6-43 Icing Potential Legend

TURBULENCE



NOTE: The Turbulence weather product cannot be displayed at the same time as the NEXRAD weather product is selected for display.

The Turbulence weather product identifies the potential for erratic movement of high-altitude air mass associated winds. Turbulence is classified as light, moderate, severe or extreme, at altitudes between 21,000 and 45,000 feet. Turbulence information is intended to supplement AIRMETs and SIGMETs.

Displaying the Turbulence weather product:

- 1) Select the Weather Data Link (XM) Page.
- 2) Press the **MORE WX** Softkey.
- 3) Press the **TURB** Softkey.
- 4) Select the desired altitude level: 21,000 feet up to 45,000 feet. Press the **NEXT** or **PREV** Softkey to cycle through the altitude softkeys. The **TURB** Softkey label changes to reflect the altitude selected.

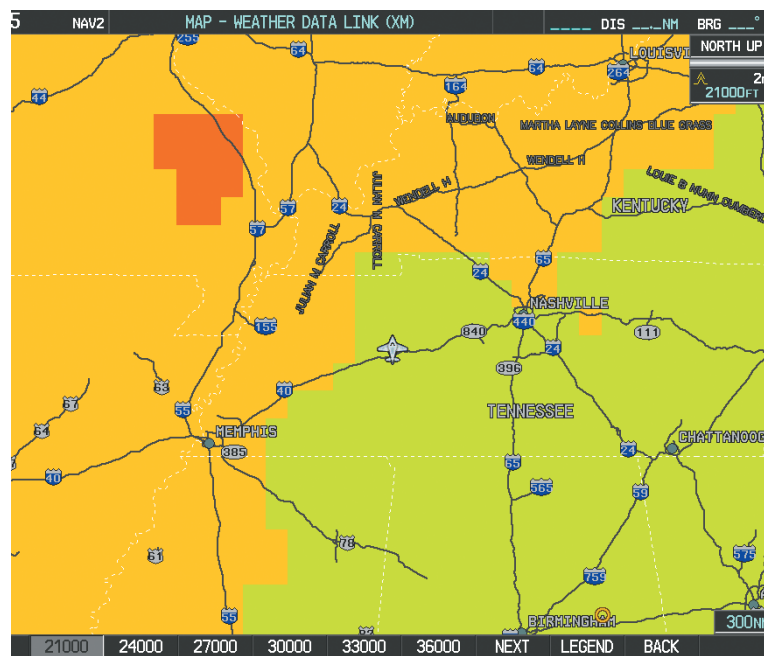

Figure 6-44 Turbulence Data at 21,000 Feet

To display the Turbulence legend (Figure 6-45), press the **LEGEND** Softkey when Turbulence is selected for display.

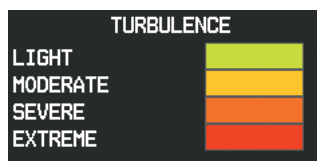

Figure 6-45 Turbulence Legend

PIREPS AND AIREPS

Pilot Weather Reports (PIREPs) are airborne weather reports collected from pilots. When significant weather conditions are reported or forecast, Air Traffic Control (ATC) facilities are required to solicit PIREPs. A PIREP may contain adverse weather conditions, such as low in-flight visibility, icing conditions, wind shear, and turbulence. PIREPs are issued as either Routine (UA) or Urgent (UUA).

Another type of PIREP is an Air Report (AIREP). Commercial airlines typically generate AIREPs.

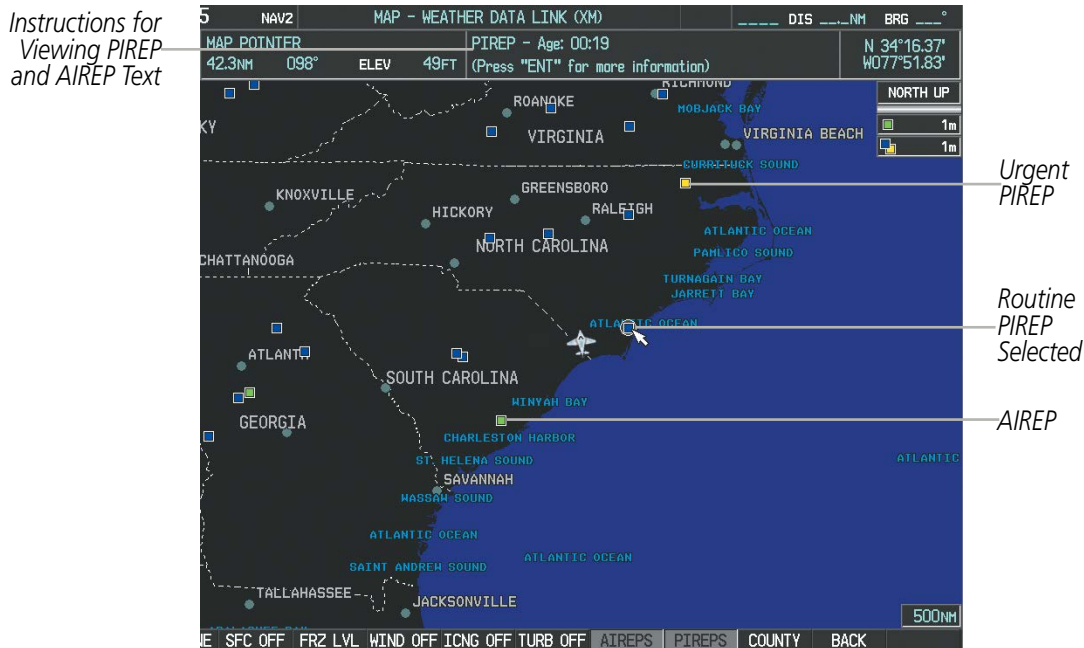

Figure 6-46 AIREPs and PIREPs on the Weather Data Link (XM) Page

Displaying PIREP and AIREP text:

- 1) Select the Weather Data Link (XM) Page.
- 2) Press the **MORE WX** Softkey.
- 3) Press the **AIREPS** or **PIREPS** Softkey.
- 4) Push the **Joystick** and pan to the desired weather report. A gray circle will appear around the weather report when it is selected.
- 5) Press the **ENT** Key. The Weather Information Page is shown with PIREP or AIREP text. The data is first displayed in a decoded fashion, followed by the original text. Note the original text may contain additional information not found in the decoded version.
- 6) Use the **FMS** Knob or the **ENT** Key to scroll through the PIREP or AIREP text.
- 7) Push the **FMS** Knob or the **CLR** Key to return to the Weather Data Link (XM) Page.

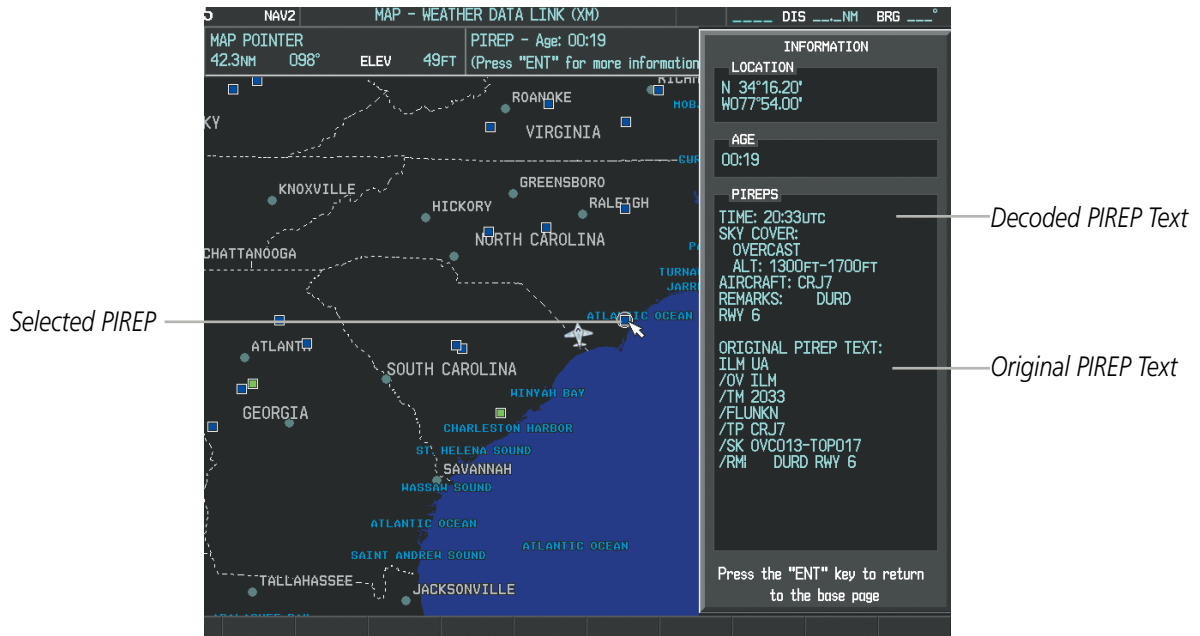

Figure 6-47 PIREP Text on the Weather Information Page

To display the PIREP or AIREP legend (Figure 6-48), press the **LEGEND** Softkey when PIREPs or AIREPs are selected for display.

The PIREP color is determined by the type (routine or urgent).



Figure 6-48 AIREPs & PIREPs Legend

TEMPORARY FLIGHT RESTRICTIONS (TFRS)



NOTE: Do not rely solely upon data link services to provide Temporary Flight Restriction (TFR) information. Always confirm TFR information through official sources such as Flight Service Stations or Air Traffic Control.

The Federal Aviation Administration (FAA) issues TFRs to designate areas where flight is restricted. TFRs are issued to restrict flight for a variety of reasons including national security, law enforcement, firefighting operations, airshows, and large sporting events. TFRs may be issued at any time, and TFR data displayed on the system is only intended to supplement TFR information obtained from official sources including Flight Service Stations (FSS), and air traffic control.

The system does not display the age TFR product was assembled on the ground by the data provider is not shown; however, if TFR product is not available or has expired, the system displays 'TFR N/A' in the upper-left corner of maps on which the display of TFR information is enabled.

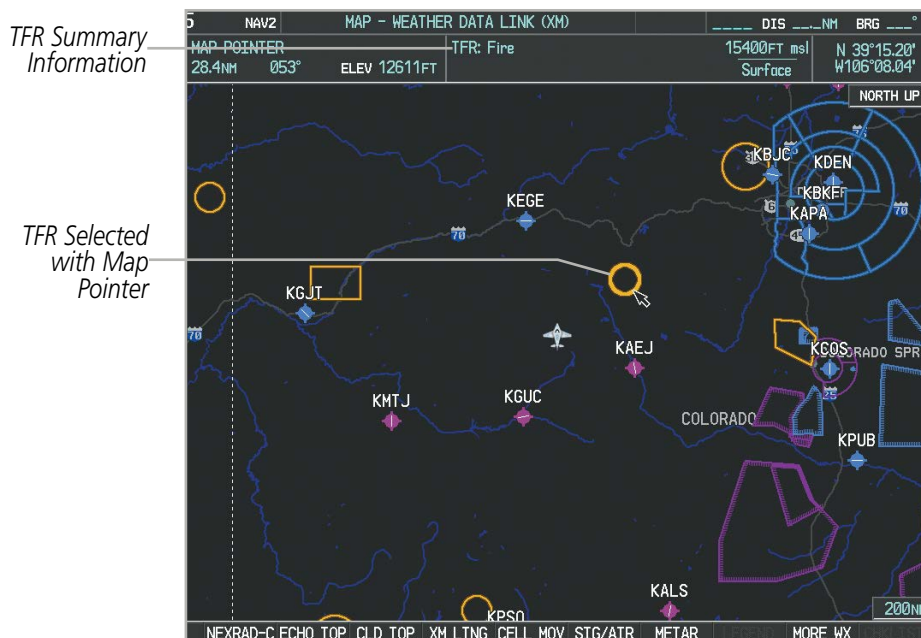

Figure 6-49 TFR Data on the Weather Data Link (XM) Page

Displaying TFR Data:

- 1) Select the Weather Data Link (XM) Page or Navigation Map Page.
- 2) Push the **Joystick** and pan the map pointer over a TFR to highlight it. The system displays TFR summary information above the map.
- 3) Press the **ENT** Key. The system displays a pop-up menu.
- 4) If necessary, turn the **FMS** Knob to select 'Review Airspaces' and press the **ENT** Key. The system displays the TFR Information window.
- 5) Push the **FMS** Knob or the **CLR** Key to remove the TFR Information window.

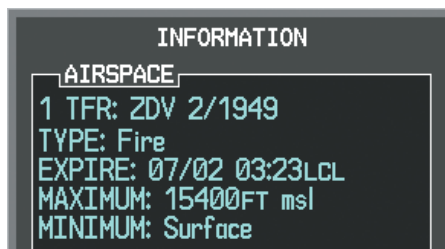

Figure 6-50 Full Text for Selected TFR

The setup menus for the Navigation Map Page control the map range settings above which TFR data is decluttered from the display. If a map range larger than the TFR product map range setting is selected, the TFR product data is removed from the map.

Maps other than the Navigation Map Page use settings based on those selected for the Navigation Map Page.

Setting up and customizing TFR data for maps on which TFR data can be displayed:

- 1) Select the Navigation Map Page.
- 2) Press the **MENU** Key.
- 3) With Map Setup highlighted, press the **ENT** Key (Figure 6-51).
- 4) Turn the small **FMS** Knob to select the Aviation Group and press the **ENT** Key (Figure 6-52).
- 5) Turn the large **FMS** Knob to scroll to the TFR product range setting (Figure 6-53).
- 6) Turn the small **FMS** Knob to scroll through options (Off, range settings).
- 7) Press the **ENT** Key to select an option.
- 8) Push the **FMS** Knob or **CLR** Key to return to the Navigation Map Page with the changed settings.

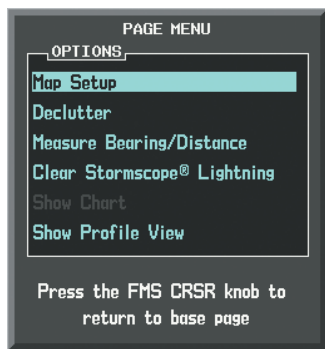

Figure 6-51 Navigation Map Page Menu



Figure 6-52 Navigation Map Page Setup Menu

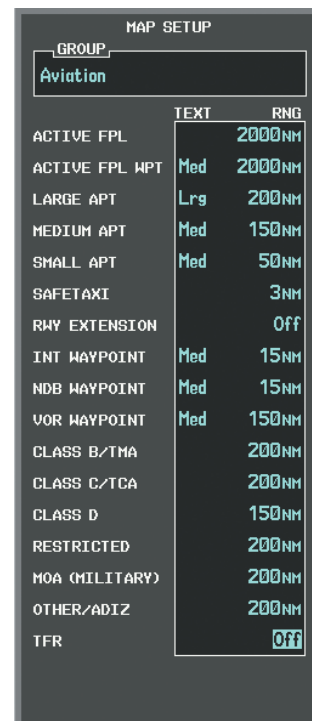

Figure 6-53 Navigation Map Page Setup Menu, Aviation Group

6.2 GARMIN CONNEXT WEATHER



WARNING: Do not use data link weather information for maneuvering in, near, or around areas of hazardous weather. Information contained within data link weather products may not accurately depict current weather conditions.



WARNING: Do not use the indicated data link weather product age to determine the age of the weather information shown by the data link weather product. Due to time delays inherent in gathering and processing weather data for data link transmission, the weather information shown by the data link weather product may be significantly older than the indicated weather product age.



NOTE: The availability of specific Garmin Connex Weather products varies by region. For product coverage information, refer to <http://fly.garmin.com/fly-garmin/connex/worldwide-weather/>.

The optional GSR 56 Iridium satellite data link receiver provides extensive weather information to the system through the Garmin Connex™ Weather service. The system displays graphical weather information and its associated text on the Multi Function Display (MFD) and the Primary Flight Display (PFD) Inset Map.

The system provides weather information after the flight crew selects either a manual or automatic Connex Data Request on the Weather Data Link (CNXT) Page on the MFD.

Garmin Connex Weather requires an active subscription to both the Iridium (satellite telephone) and Garmin Connex Weather services.

ACCESSING GARMIN CONNEXT WEATHER PRODUCTS

The primary map for viewing Garmin Connex Weather information is the Weather Data Link (CNXT) Page in the Map Page Group (Figure 6-57). This is the only map display capable of showing information for all available Garmin Connex weather products, with the exception of TAFs, which are discussed later. No weather data is displayed until an initial Connex Weather Data Request has been completed.

Viewing the Weather Data Link (CNXT) Page:

- 1) Turn the large **FMS** Knob to select the Map Page Group.
- 2) Turn the small **FMS** Knob to select the Weather Data Link (CNXT) Page. If the name of another weather data service provider is listed in the page title (such as 'XM'), proceed to the next step.
- 3) Press the MENU Key.
- 4) Turn the large **FMS** Knob to select 'Display Connex Weather' and and press the **ENT** Key. The page title changes to 'Weather Data Link (CNXT)' to indicate Garmin Connex is now the selected weather source.

REGISTERING THE IRIDIUM SATELLITE SYSTEM

Before setting up an Iridium account, obtain the serial number of the Iridium Transceiver (GSR1) and the System ID by selecting the AUX - SYSTEM STATUS Page as shown in Figure 6-54. Then go to the website www.flygarmin.com and follow the instructions for establishing an account for Garmin Connex data services. Note additional information about the airframe may be required. After an account has been established, Garmin

provides an access code that must be entered on the system and successfully transmitted to the Garmin Connex service via the Iridium satellite network.



Iridium Transceiver Serial Number

System ID Number

Figure 6-54 Identification Needed for Iridium Registration

REGISTERING THE SYSTEM FOR GARMIN CONNEXT WEATHER

After a subscriber account has been established, the system must be registered to receive Garmin Connex Weather data. Registration is accomplished by entering the required access code provided by Garmin. This process is only performed when initially setting up the system for Garmin Connex Weather.

Registering the system to receive Garmin Connex Weather:

- 1) With the aircraft outside and having a clear view of the sky, turn the large **FMS** Knob on the MFD to select the MAP page group.
- 2) Turn the small **FMS** Knob to select the MAP-WEATHER DATA LINK (CNXT or XM) Page. If 'XM' is displayed in the page title, it will be necessary to change the data link weather source to Garmin Connex (CNXT) before continuing. Refer to 'Viewing the Weather Data Link (CNXT) Page' procedure to change the data link weather source to Garmin Connex prior to registration.
- 3) If the system displays the 'CONNEXT REGISTRATION' Window, proceed to step 7. Otherwise, press the **MENU** Key. The Page Menu window is now displayed as seen in Figure 6-55.



Figure 6-55 Select 'Register With Connex'

- 4) Turn the large **FMS** Knob to select 'Register With Connex' in the menu list.
- 5) Press the **ENT** Key. The system displays the CONNEXT REGISTRATION Window as shown in Figure 6-56.

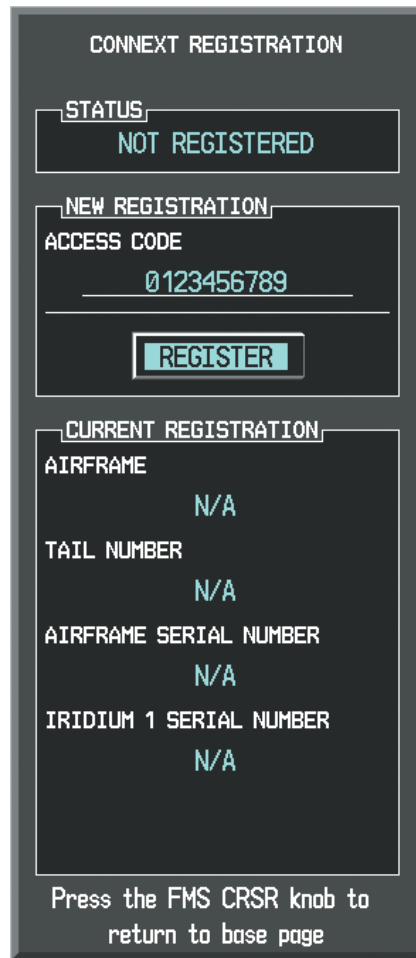

Figure 6-56 Enter Access Code

- 6) Enter the access code provided by Garmin customer service in the ACCESS CODE field.
- 7) Press the **ENT** Key. 'REGISTER' will now be highlighted as in Figure 6-56.
- 8) Press the **ENT** Key. The system contacts Garmin Connex services. System registration is complete when 'REGISTERED' is displayed in the STATUS field.

- SYSTEM OVERVIEW
- FLIGHT INSTRUMENTS
- EIS
- AUDIO PANEL & CNS
- FLIGHT MANAGEMENT
- HAZARD AVOIDANCE
- AFCS
- ADDITIONAL FEATURES
- APPENDICES
- INDEX

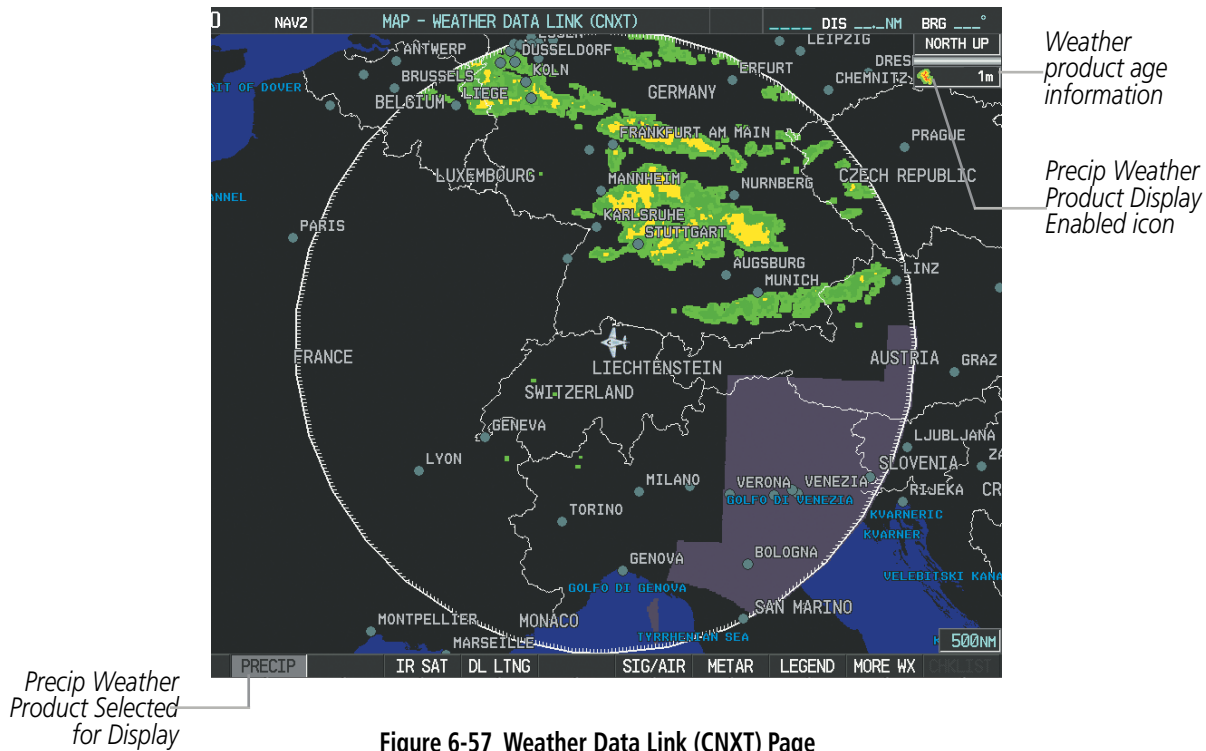









Figure 6-57 Weather Data Link (CNXT) Page (After Connex Data Request)

When a weather product is selected for display on the Weather Data Link (CNXT) Page, a box containing a symbol for the product and its age (in minutes) are shown in the upper right (Figure 6-57). If weather data has not been requested yet or is not available, 'N/A' is shown next to the product symbol instead of age. The age of the weather product is based on the time difference between when the data was assembled on the ground and the current GPS time. Weather products are updated continuously or refreshed at specific intervals (defined in the **Refresh Rate** column in Table 6-4).

If for any reason, a weather product is not refreshed within the defined **Expiration Time** intervals (see Table 6-4), the data is considered expired and is removed from the display. The age of the expired product is replaced by dashes. If more than half of the expiration time has elapsed, the color of the product age changes to amber. Table 6-4 shows the Garmin Connex weather product symbols, the expiration time and the refresh rates. The refresh rate represents the interval at which the Garmin Connex ground-based servers make available the most current known weather data. It does not necessarily represent the rate at which new content is received from weather sources.



NOTE: The availability of specific Garmin Connex Weather products varies by region. For product coverage information, refer to <http://fly.garmin.com/fly-garmin/connex/worldwide-weather/>.

Garmin Connex Weather Product	Symbol	Expiration Time (Minutes)	Refresh Rate (Minutes)
Radar Precipitation (PRECIP)		30	U.S.: 3* Canada: 3*† Europe: 15 Australia: 15^
Infrared Satellite (IR SAT)		60	30
Data Link Lightning (DL LTNG)		30	Continuous
SIGMETs/AIRMETs (SIG/AIR)		60	Continuous
Meteorological Aerodrome Report (METARs)		90	Continuous
Winds Aloft (WIND)		60	Continuous
Pilot Weather Report (PIREPs)		90	Continuous
Temporary Flight Restrictions (TFRs)	no product image	60	Continuous
Terminal Aerodrome Reports (TAFs)	no product image	60	Continuous

* The precipitation mosaic is updated every 3 minutes, but individual radar sites may take between 3 and 10 minutes to provide new data.

† Canadian radar precipitation data provided by Environment Canada.

^ Australian radar precipitation data provided by the Australia Bureau of Meteorology

Table 6-4 Garmin Connex Weather Product Symbols and Data Timing

Table 6-5 shows which Garmin Connex Weather products can be displayed (indicated with a '+' symbol) on specific Perspective® maps.

Garmin Connex Weather Product	PFD Inset Map	Navigation Map Page	Weather Data Link (CNXT) Page	Weather Information Page	AUX - Trip Planning Page	AUX - Video Page	Nearest Page Group	Flight Plan Pages
Precipitation (PRECIP)	+	+	+		+	+	+	+
Infrared Satellite (IR SAT)			+					
Garmin Connex Lightning (DL LTNG)	+	+	+		+		+	+
SIGMETs/AIRMETs (SIG/AIR)			+					
METARs	+	+	+	+	+	+	+	+
Winds Aloft (WIND)		+	+*					
PIREPs			+	+				
Radar Coverage	+	+	+					
TFRs	+	+	+	+	+	+	+	+
TAFs				+				

* Winds Aloft data available on Navigation Map Page inside Profile View window.

Table 6-5 Garmin Connex Weather Product Display Maps

Softkeys control the display of weather information on most MFD pages and the PFD Inset Map (Figure 6-58 shows the weather product softkeys for the Weather Data Link (CNXT) Page). When a weather product is selected for display, the corresponding softkey label changes to gray to indicate the product display is enabled.

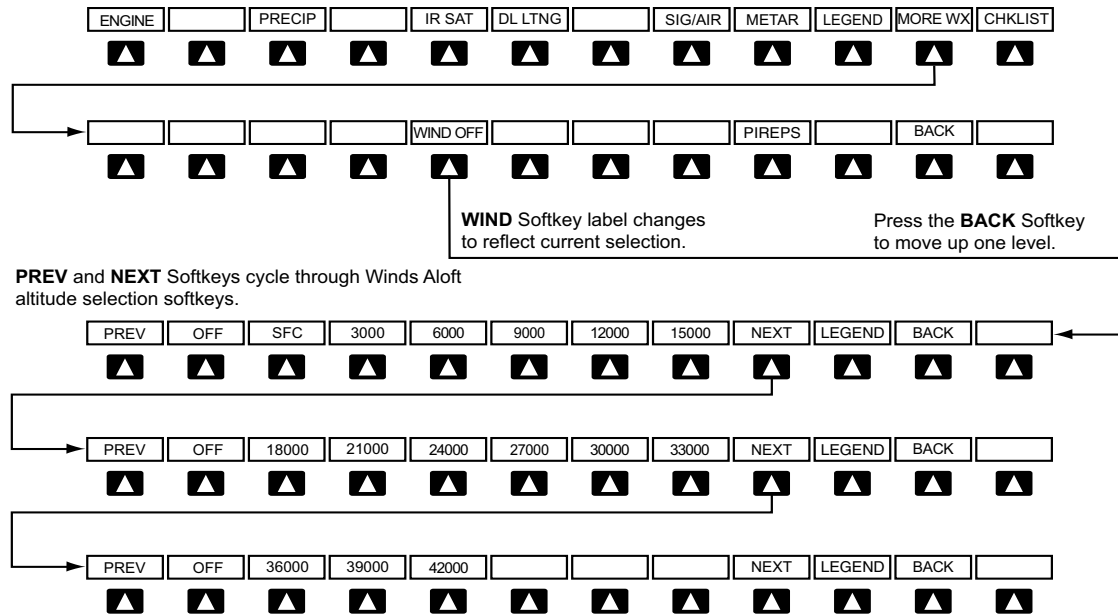

Figure 6-58 Weather Data Link (CNXT) Page Softkeys (MFD)

The setup menus for the Navigation Map Page and the Weather Data Link (CNXT) Page control the map range settings above which weather products data are decluttered from the display. If a map range larger than the weather product map range setting is selected, the weather product data is removed from the map. The menus also provide a means in addition to the softkeys for enabling/disabling display of weather products.

Setting up and customizing the Weather Data Link (CNXT) Page:

- 1) Select the Weather Data Link (CNXT) Page.
- 2) Press the **MENU** Key.
- 3) With 'Weather Setup' highlighted, press the **ENT** Key (Figure 6-59).
- 4) Turn the small **FMS** Knob to select 'PRODUCT GROUP 1' or 'PRODUCT GROUP 2', and press the **ENT** Key (Figure 6-60).
- 5) Turn the large **FMS** Knob or press the **ENT** Key to scroll through product selections.
- 6) Turn the small **FMS** Knob to scroll through options for each product (ON/OFF, range settings, etc.).
- 7) Press the **ENT** Key to select an option.
- 8) Push the **FMS** Knob or **CLR** Key to return to the Weather Data Link (CNXT) Page with the changed settings.

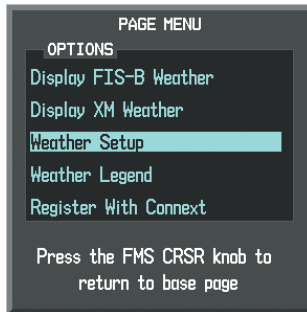

Figure 6-59 Weather Data Link (CNXT) Page Menu

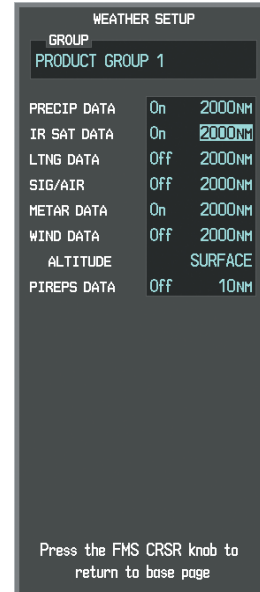

Figure 6-60 Weather Data Link (CNXT) Page Setup Menu

Restoring default Weather Data Link (CNXT) Page settings:

- 1) Select the Weather Data Link (CNXT) Page.
- 2) Press the **MENU** Key.
- 3) With 'Weather Setup' highlighted, press the **ENT** Key.
- 4) Press the **MENU** Key.
- 5) Highlight the desired default(s) to restore (all or for selection) and press **ENT** Key.

If multiple data link weather services are installed, customizing the display settings for the corresponding weather products shown in Table 6-6 will result in identical settings for a comparable weather product from another service provider.

SiriusXM Weather Product and Softkey	Garmin Connex Weather Product	FIS-B Weather Product
Next-generation Radar (NEXRAD) and No Radar Coverage	Precipitation (PRECIP) and No Radar Coverage	Next-generation Radar (NEXRAD) and No Radar Coverage
Cloud Top (CLD TOP)	Infrared Satellite (IR SAT)	Not Available
SiriusXM Lightning (XM LTNG)	Garmin Connex Data Link Lightning (DL LTNG)	Not Available
SIGMETs/AIRMETs (SIG/AIR)	SIGMETs/AIRMETs (SIG/AIR)	SIGMETs/AIRMETs (SIG/AIR)
Meteorological Aerodrome Report (METARs)	Meteorological Aerodrome Report (METARs)	Meteorological Aerodrome Report (METARs)
Winds Aloft (WIND)	Winds Aloft (WIND)	Winds Aloft (WIND)
Pilot Weather Report (PIREPs)	Pilot Weather Report (PIREPs)	Pilot Weather Report (PIREPs)

Table 6-6 Weather Data Link Map Settings Shared for Multiple Weather Data Link Sources

Maps besides the Weather Data Link (CNXT) Page use settings based on those selected for the Navigation Map Page.

Setting up and customizing weather data for the Navigation Map Page:

- 1) Select the Navigation Map Page.
- 2) Press the **MENU** Key.
- 3) With 'Map Setup' highlighted, press the **ENT** Key (Figure 6-61).
- 4) Turn the small **FMS** Knob to select the 'Weather' Group and press the **ENT** Key (Figure 6-62).
- 5) Turn the large **FMS** Knob or press the **ENT** Key to scroll through product selections (Figure 6-63).
- 6) Turn the small **FMS** Knob to scroll through options for each product (ON/OFF, range settings).
- 7) Press the **ENT** Key to select an option.
- 8) Push the **FMS** Knob or **CLR** Key to return to the Navigation Map Page with the changed settings.

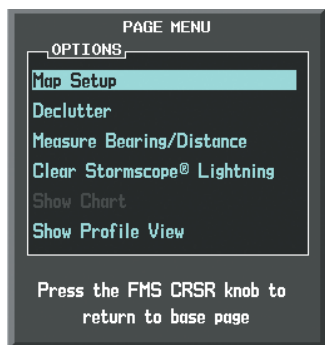

Figure 6-61 Navigation Map Page Menu

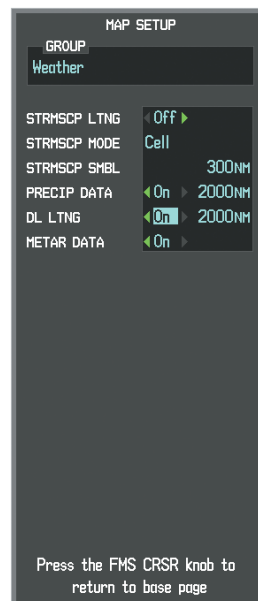

Figure 6-63 Navigation Map Page Setup Menu, Weather Group

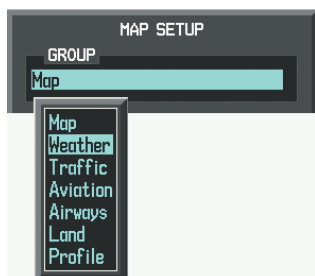

Figure 6-62 Navigation Map Page Setup Menu

Each active weather product has an associated legend which can be displayed on the Weather Data Link (CNXT) Page. If no weather product softkeys are selected, the **LEGEND** Softkey will be unavailable.

Viewing legends for displayed weather products

- 1) Select the Weather Data Link (CNXT) Page.
- 2) Select the **LEGEND** Softkey to display the legends for the displayed weather products.
 - Or:
 - a) Press the **MENU** Key.
 - b) Select 'Weather Legend' and press the **ENT** Key.
- 3) Turn the **FMS** Knob to scroll through the legends if more are available than fit in the window.
- 4) To remove the Legend Window, select the **LEGEND** Softkey, the **ENT** or the **CLR** Key, or push the **FMS** Knob.

Additional information about the following can be displayed by panning over the display on the map:

- Infrared Satellite (IR SAT)
- SIGMETs
- AIRMETs
- METARs
- TFRs
- PIREPs

The map panning feature is enabled by pressing the **Joystick**. The map range is adjusted by turning the **Joystick**. If the map range is adjusted while panning is enabled, the map is re-centered on the Map Pointer.

Instructions for Viewing METAR and TAF Text

Selected Airport

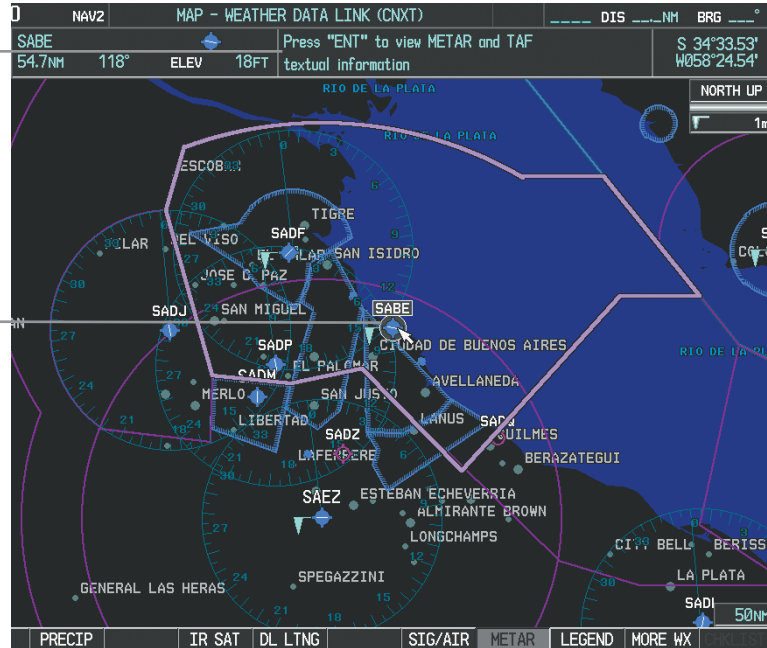

Figure 6-64 Panning on the Weather Data Link (CNXT) Page

CONNEXT WEATHER DATA REQUESTS

The Connext Data Request window provides the flight crew with the options to enable or disable the requested weather coverage area(s), choose automatic weather update intervals (if desired), and the ability to send or cancel weather data requests. The status of the Connext Data Request process is also displayed.

Before a Connext Data Request can occur, a valid request coverage area must be defined from which all currently available Garmin Connext weather products will be retrieved. At a minimum, either the aircraft's present position or a waypoint (as part of a flight plan or entered directly in the 'WAYPOINT' coverage field) must be part of the request coverage area, otherwise the request status window will indicate 'INVALID COVERAGE AREA' and the system will not allow a request to occur.

It is not necessary for a destination (based on an active flight plan), a flight plan, or waypoint to be specified prior to enabling these coverage areas; however no weather data will be retrieved for these option(s) until a flight plan or waypoint is provided, respectively.

Requesting Garmin Connext weather data manually:

- 1) Select the Weather Data Link (CNXT) Page.
- 2) Press the **MENU** Key.
- 3) With 'Connext Data Request' highlighted, press the **ENT** Key (Figure 6-65).
- 4) Turn the large **FMS** Knob to highlight the desired coverage option(s) and press the **ENT** Key to select or deselect one of more of the following coverage selections (Figures 6-66, 6-67):
 - **PRESENT POSITION** – Requests data based on current location.
 - **DESTINATION** – Requests data based on the active flight plan destination (Direct-To destinations excluded). See the Flight Management section for more information about entering and activating flight plans.

- FPL – Requests data along an active flight plan, if one exists. Turn the small **FMS** Knob to select the desired flight plan look-ahead distance option (or choose 'REMAINING FPL' to request the remainder of the flight plan), then press the **ENT** Key.
 - WAYPOINT – Requests data based on a waypoint (which may be off-route). Turn the large and small **FMS** Knobs to enter a waypoint, then press the **ENT** Key.
- 5) Turn the large **FMS** Knob highlight to the 'DIAMETER / RTE WIDTH' (diameter/route width) distance field and turn the small **FMS** Knob to select the desired diameter and route width of the request, then press the **ENT** Key.
 - 6) Turn the large **FMS** Knob until the 'SEND REQ' button is highlighted. Press the **ENT** Key to initiate the request immediately or push the **FMS** Knob to return to the Weather Data Link (CNXT) Page without requesting weather data.



Figure 6-65 Weather Data Link (CNXT) Page Menu

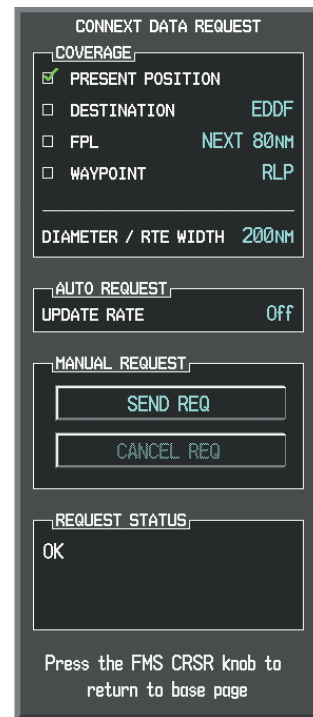
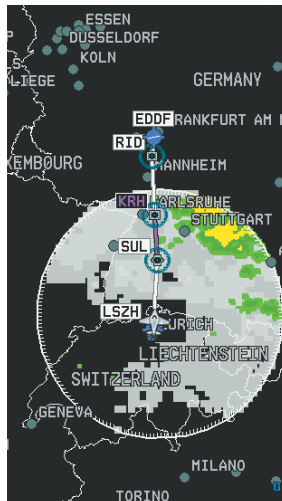

Figure 6-66 Connext Data Request Window



CONNEXT DATA REQUEST

COVERAGE

- PRESENT POSITION
- DESTINATION EDDF
- FPL NEXT 80NM
- WAYPOINT RLP

DIAMETER / RTE WIDTH 200NM

Present Position Selected, 200 nm Diameter Requested

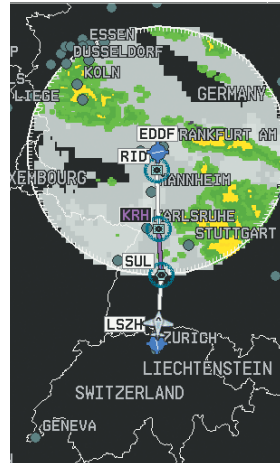

CONNEXT DATA REQUEST

COVERAGE

- PRESENT POSITION
- DESTINATION EDDF
- FPL NEXT 80NM
- WAYPOINT RLP

DIAMETER / RTE WIDTH 200NM

Destination Selected, 200 nm Diameter Requested

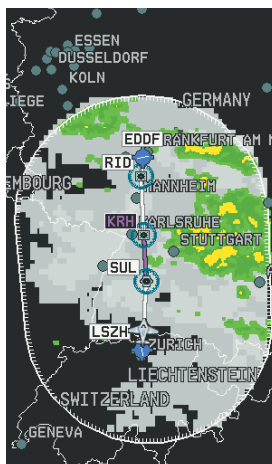

CONNEXT DATA REQUEST

COVERAGE

- PRESENT POSITION
- DESTINATION EDDF
- FPL NEXT 80NM
- WAYPOINT RLP

DIAMETER / RTE WIDTH 200NM

Next 80 nm of Flight Plan Selected, 200 nm Route Width Requested

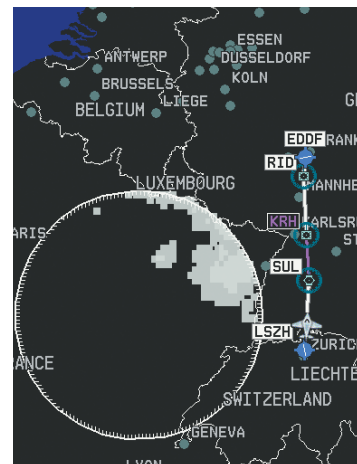

CONNEXT DATA REQUEST

COVERAGE

- PRESENT POSITION
- DESTINATION EDDF
- FPL NEXT 80NM
- WAYPOINT RLP

DIAMETER / RTE WIDTH 200NM

Off-Route Waypoint Selected, 200 nm Diameter Requested

Figure 6-67 Connext Data Request Results with Precipitation and Infrared Satellite Displayed

During a Connext Data Request, the Request Status box initially displays “Contacting Connext...”. Once a connection is established, the Request Status Box displays “Receiving Wx Data... Time Remaining:” with an estimated data transfer time (either minutes or seconds). If desired, the Connext Data Request window may be closed while the data request is processing by pushing the **FMS** Knob; the data request will continue to process in the background. Connext Data Requests typically take between 1 to 4 minutes to complete depending on the size of the selected weather coverage area and Iridium signal strength.

The system retrieves all available Garmin Connext Weather products within the selected coverage area during an initial Connext Data Request, regardless of which products (if any) are currently enabled for display. On subsequent requests, previously retrieved textual data (such as METARs and TAFs) is retained if it has not expired, while new textual weather data matching the current coverage area and all graphical weather data is downloaded during every data request.

At the completion of a successful weather data request, the request status window (if still open) will indicate 'OK'.

Cancelling a Connex Weather Data Request in Progress:

- 1) Select the Weather Data Link (CNXT) Page.
- 2) Press the **MENU** Key.
- 3) With 'Connex Data Request' highlighted, press the **ENT** Key.
- 4) Turn the large **FMS** Knob to select 'CANCEL REQ' and press the **ENT** Key. The request status box indicates 'Request Cancelled'.
- 5) Push the **FMS** Knob to return to the Weather Data Link (CNXT) Page.

The pilot can schedule Connex Data Requests to recur automatically. Auto requests remain enabled until the pilot disables them, or the system power is cycled. The Request Status window will indicate a countdown timer until the next automatic data request occurs.



NOTE: If automatic Connex Data Requests were enabled prior to the system entering Reversionary Mode, the automatic weather data requests will continue in Reversionary Mode, however the Connex Data Request window and its associated options will not be available.

Enabling/disabling automatic Connex Data Requests:

- 1) Select the Weather Data Link (CNXT) Page.
- 2) Press the **MENU** Key.
- 3) With 'Connex Data Request' highlighted, press the **ENT** Key.
- 4) Choose the desired weather coverage options.
- 5) Turn the large **FMS** Knob to select the 'UPDATE RATE' setting. Then turn the small **FMS** Knob to highlight the desired automatic update frequency (Off, 5 Min, 10 Min, 15 Min, 20 Min, 30 Min, 45 Min, or 60 Min), then press the **ENT** Key.
- 6) The 'SEND REQ' button is highlighted and a countdown timer is displayed in the 'REQUEST STATUS' based on the currently selected update rate. Press the **ENT** Key to immediately send an immediate Connex Data Request.

Or:

Push the **FMS** Knob to return to the Weather Data Link (CNXT) Page.

GARMIN CONNEXT WEATHER PRODUCTS

PRECIPITATION

The Precipitation weather product provides radar precipitation information in selected radar coverage areas. This information comes from individual weather radar sites and weather data sources such as government agencies. Each radar site or source may provide weather data at differing rates and times. Periodically, the Garmin Connex Weather service compiles the available information to form a composite image, and assigns a single time to indicate when it created the image. This image becomes the Precipitation weather product. Individual images--gathered from each radar site--differ in age, and are always older than the displayed Precipitation weather product age.

Because of the time required to detect, assemble, and distribute the Precipitation weather product, the displayed weather information contained within the product may be significantly older than the current radar synopsis and may not depict the current weather conditions. The Precipitation weather product should never be used as a basis for maneuvering in, near, or around areas of hazardous weather regardless of the information it contains.

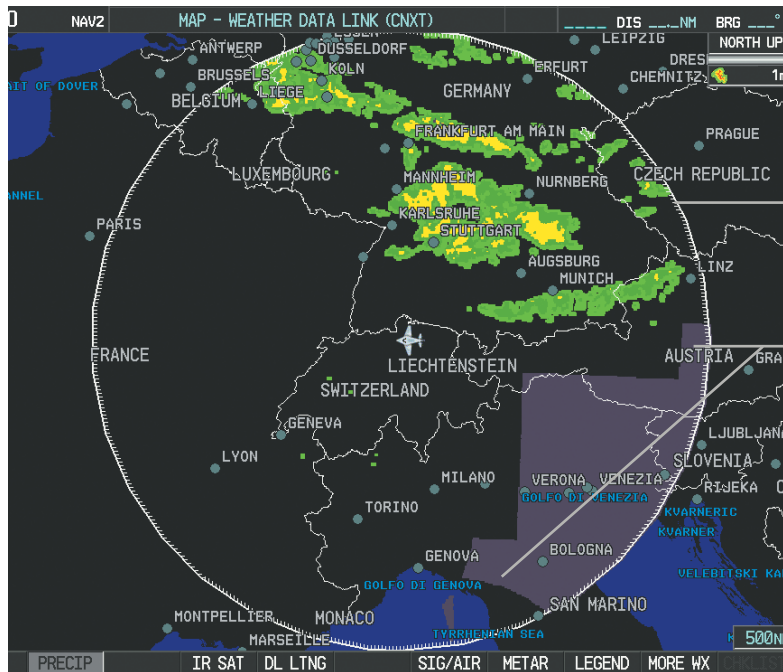

Boundary of weather data request (shown when Precipitation is enabled)

No Radar Coverage within request area

Figure 6-68 Precipitation Data on the Weather Data Link (CNXT) Page

Precipitation data can be displayed on the following maps:

- PFD Inset Map
- Navigation Map Page
- Weather Data Link (CNXT) Page
- Airport Information Page
- Trip Planning Page
- Nearest Pages
- Flight Plan Pages
- AUX - Video Page

Displaying Precipitation weather information:

- 1) Select the **MAP** Softkey (for the PFD Inset Map, select the **INSET** Softkey). This step is not necessary on the Weather Data Link (CNXT) Page.
- 2) Press the **PRECIP** Softkey.

The system displays either base or composite NEXRAD imagery, depending on the region.

Region	Radar Reflectivity Type
United States	Composite Reflectivity
Canada, Europe, Australia	Base Reflectivity

The base reflectivity precipitation weather product shows the radar returns from the perspective of a single antenna tilt angle. The composite reflectivity precipitation weather product shows the *highest* radar energy received from multiple antenna tilt angles. The display of the information is color-coded to indicate the intensity of the echoes and the type of precipitation.

All weather product legends can be viewed on the Weather Data Link (CNXT) Page. For the Precipitation legend (Figure 6-69), press the **LEGEND** Softkey when Precipitation is selected for display.

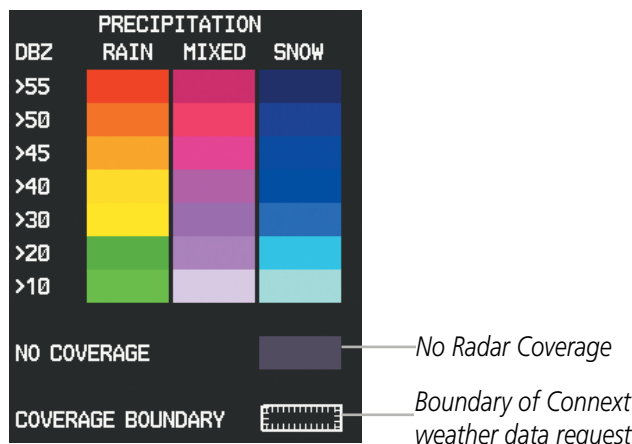

Figure 6-69 Precipitation Data Legend

The display of No Radar Coverage is enabled when Precipitation is selected for display. Areas where precipitation radar coverage is not currently available or is not being collected are indicated in gray shade of purple. A white boundary line with white tick marks depicts the selected coverage area of the Connxt Data Request. This boundary encloses the precipitation data when this weather product is displayed.

REFLECTIVITY

Reflectivity is the amount of transmitted power returned to the radar receiver. Colors on the Precipitation display directly correlate to the level of detected reflectivity. Reflectivity as it relates to hazardous weather can be very complex.

The role of radar is essentially to detect moisture in the atmosphere. Simply put, certain types of weather reflect radar better than others. The intensity of a radar reflection is not necessarily an indication of the weather hazard level. For instance, wet hail returns a strong radar reflection, while dry hail does not. Both wet and dry hail can be extremely hazardous.

The different radar echo intensities are measured in decibels (dB) relative to reflectivity (Z). Weather radars measure the reflectivity ratio, or the energy reflected *back to* the radar receiver (designated by the letter Z). The value of Z increases as the returned signal strength increases.

PRECIPITATION LIMITATIONS

Radar images may have certain limitations:

- Undetermined precipitation types may be displayed as mixed.
- Base reflectivity is sampled at the minimum antenna elevation angle. An individual radar site cannot depict high altitude storms at close ranges. It has no information about storms directly over the site.
- When zoomed in to a range of 30 nm, each square block on the display represents an area of four square kilometers.
- The radar beam may overshoot precipitation occurring below the radar beam, which will be undetected.

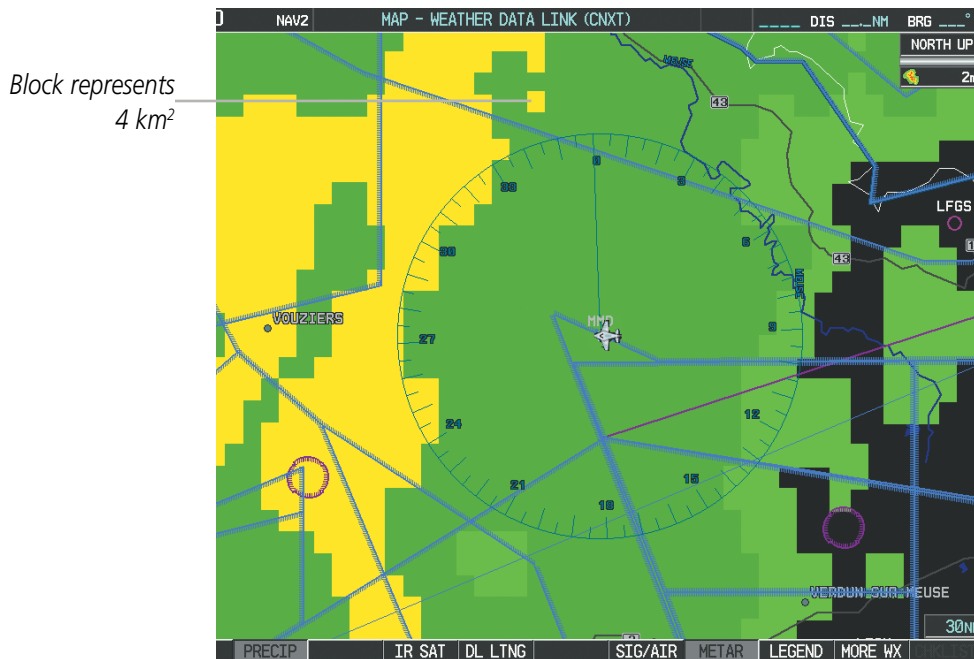

Figure 6-70 Precipitation Weather Product - Zoomed

The following may cause abnormalities in displayed radar images:

- Ground clutter
- Strokes and spurious radar data
- Sun strokes (when the radar antenna points directly at the sun)
- Interference from buildings or mountains, which may cause shadows
- Metallic dust (chaff) from military aircraft, which can cause alterations in radar scans

INFRARED SATELLITE

The Infrared Satellite (IR SAT) weather product (Figure 6-71) depicts cloud top temperatures from satellite imagery. Brighter cloud top colors indicate cooler temperatures occurring at higher altitudes.

When the Map Pointer is activated and panning over an area of displayed cloud tops, the system shows a range of cloud top temperatures for the selected location.

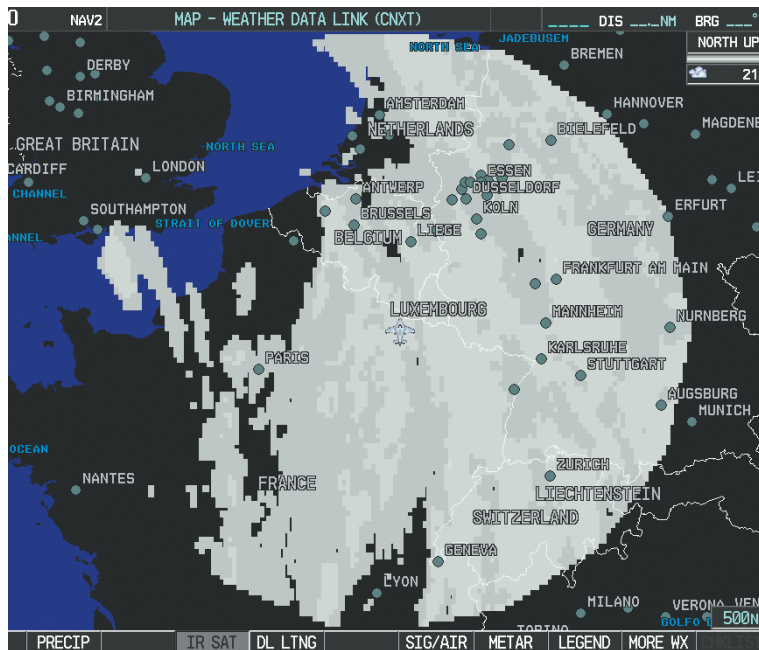

Figure 6-71 Infrared Satellite Data on the Weather Data Link (CNXT) Page

Displaying Cloud Tops information:

- 1) Select the Weather Data Link (CNXT) Page.
- 2) Press the **IR SAT** Softkey.

To display the Infrared Satellite legend (Figure 6-72), press the **LEGEND** Softkey when Infrared Satellite data is selected for display.



Figure 6-72 Infrared Satellite Legend

GARMIN CONNEXT DATA LINK LIGHTNING

The Garmin Connex Data Link Lightning (DL LTNG) weather product (Figure 6-73) shows the approximate location of cloud-to-ground lightning strikes. A strike icon represents a strike that has occurred within a two-kilometer region. Neither cloud-to-cloud nor the exact location of the lightning strike is displayed.

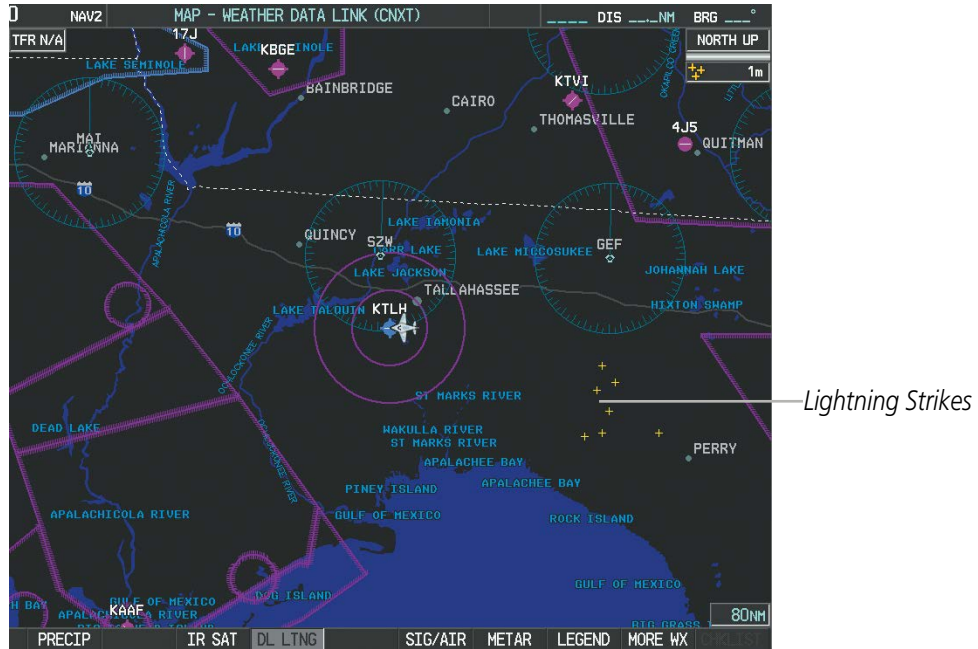

Figure 6-73 Garmin Connex Data Link Lightning

Displaying Data Link Lightning information:

- 1) Press the **MAP** Softkey (for the PFD Inset Map, select the **INSET** Softkey). This step is not necessary on the Weather Data Link (CNXT) Page.
- 2) Press the **DL LTNG** Softkey.

To display the Data Link Lightning legend on the Weather Data Link (CNXT) Page (Figure 6-74), select the **LEGEND** Softkey when Data Link Lightning is selected for display.

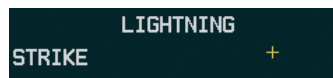

Figure 6-74 Data Link Lightning Legend

SIGMETS AND AIRMETS

SIGMETs (SIGnificant METeorological Information) and AIRMETS (AIRMen’s METeorological Information) are issued for potentially hazardous weather. A Convective SIGMET is issued for hazardous convective weather such as severe or widespread thunderstorms. A localized SIGMET can be displayed when significant weather conditions are not widespread.

The entire SIGMET or AIRMET is displayed as long as any portion of it is issued within the coverage area of the Connex Data Request.



Figure 6-75 SIGMET/AIRMET Data

Displaying SIGMETs and AIRMETS:

- 1) Select the Weather Data Link (CNXT) Page.
- 2) Press the **SIG/AIR** Softkey.
- 3) To view the text of the SIGMET or AIRMET, push the **Joystick** and move the Map Pointer over the icon.
- 4) Press the **ENT** key. Figure 6-76 shows sample SIGMET text.

To display the SIGMET and AIRMET legend (Figure 6-77), select the **LEGEND** Softkey when SIGMETs and AIRMETS are selected for display.

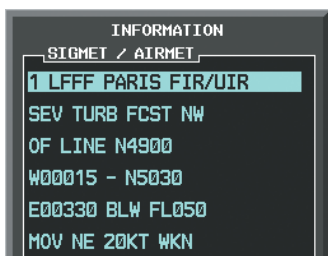

Figure 6-76 Sample SIGMET Text



Figure 6-77 SIGMET/AIRMET Legend

METARS AND TAFS



NOTE: METAR information is only displayed within the installed navigation database service area.

METARs (METeorological Aerodrome Reports) typically contain information about the temperature, dewpoint, wind, precipitation, cloud cover, cloud base heights, visibility, and barometric pressure at an airport or observation station. They can also contain information on precipitation amounts, lightning, and other critical data. METARs reflect hourly observations; non-routine updates include the code “SPECI” in the report. METARs are shown as colored flags at airports that provide them.

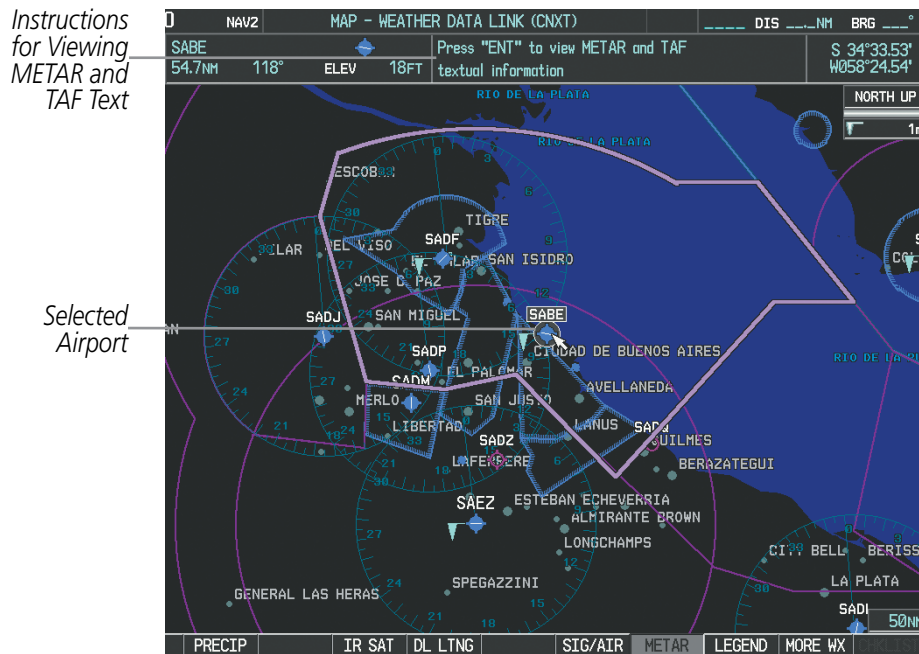

Figure 6-78 METAR Flags on the Weather Data Link (CNXT) Page

TAFs (Terminal Aerodrome Forecasts) are weather predictions for specific airports typically within a 24-hour period, but may span a longer period. TAFs may include forecast wind, visibility, weather phenomena, and sky conditions using METAR codes.

METAR and TAF text are displayed on the Weather Information Page. METAR data is displayed first in a decoded fashion, followed by the original text. Note the original text may contain additional information not found in the decoded version. TAF information, when available, is displayed only in its original form.

Displaying METAR and TAF text:

- 1) On the Weather Data Link (CNXT) Page, press the **METAR** Softkey.
- 2) Push the **Joystick** and pan to the desired airport.
- 3) Press the **ENT** Key. The Weather Information Page is shown with METAR and TAF text.
- 4) Use the **FMS** Knob or the **ENT** Key to scroll through the METAR and TAF text. METAR text must be completely scrolled through before scrolling through the TAF text.
- 5) Push the **FMS** Knob or the **CLR** Key to return to the Weather Data Link (CNXT) Page.

Or:

- 1) Select the Weather Information Page.
 - a) Turn the large **FMS** Knob to select the Waypoint Page Group.
 - b) Select the **WX** Softkey to select the Weather Information Page.
- 2) Push the **FMS** Knob to display the cursor.
- 3) Use the **FMS** Knob to enter the desired airport and press the **ENT** Key.
- 4) Use the **FMS** Knob or the **ENT** Key to scroll through the METAR and TAF text. Note that the METAR text must be completely scrolled through before scrolling through the TAF text.

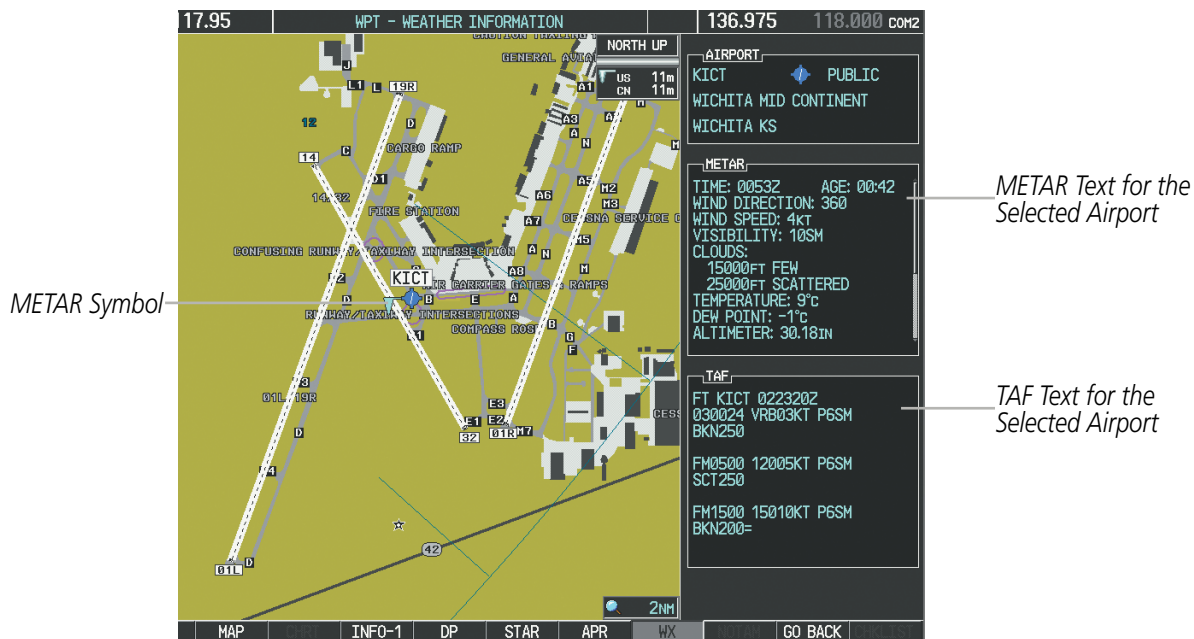

Figure 6-79 METAR and TAF Text on the Weather Information Page

Original METAR text is also accessible while panning the map cursor over a METAR flag on any map page on which a METAR is displayed. The METAR text is shown in a box near the METAR flag.

In addition, METAR flags and their associated text are displayed on the Active Flight Plan Page on the MFD. METAR flags appear next to waypoints in the flight plan with an associated METAR. A solid METAR flag indicates the METAR observations are available for a specific waypoint; a hollow METAR flag indicates an off-route METAR near the waypoint is available.

Displaying original METAR text on the Active Flight Plan Page:

- 1) Select the Active Flight Plan Page on the MFD.
- 2) Push the **FMS** Knob to activate the cursor.
- 3) Turn the large **FMS** Knob to highlight the desired waypoint. The METAR text will appear in the 'SELECTED WAYPOINT WEATHER' window below.
- 4) When finished, push the **FMS** Knob to remove the cursor or press the **FPL** Key to exit the Active Flight Plan Page.

To display the METAR legend on the Weather Data Link (CNXT) Page (Figure 6-80), select the **LEGEND** Softkey when METARs are selected for display.

The METAR flag color is determined by the information in the METAR text. A gray METAR flag is displayed when the METAR text does not contain adequate information to determine the METAR category.



Figure 6-80 METAR Legend

WINDS ALOFT

Winds Aloft data (Figure 6-81) shows the forecasted wind speed and direction at the surface and at selected altitudes. Altitude can be displayed in 3,000-foot increments from the surface up to 42,000 feet MSL.

Displaying Winds Aloft data:

- 1) Select the Weather Data Link (CNXT) Page.
- 2) Press the **MORE WX** Softkey.
- 3) Press the **WIND** Softkey.
- 4) Select the desired altitude level: SFC (surface) up to 42,000 feet. Select the **NEXT** or **PREV** Softkey to cycle through the altitude softkeys. The **WIND** Softkey label changes to reflect the altitude selected.

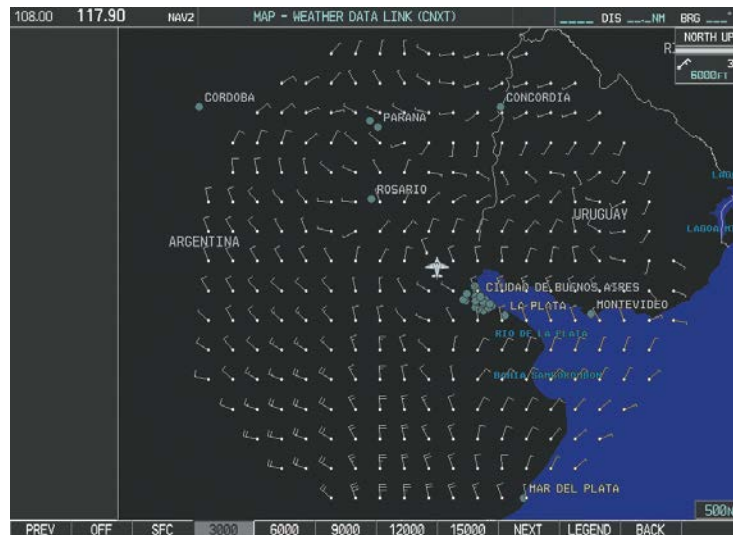

Figure 6-81 Winds Aloft at 6,000 Feet

To display the Winds Aloft legend (Figure 6-82), select the **LEGEND** Softkey when Winds Aloft is selected for display.

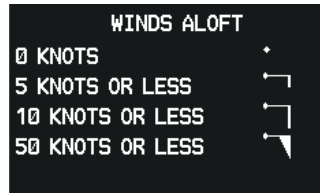

Figure 6-82 Winds Aloft Data with Legend

Headwind and tailwind components aloft are available inside the Profile View on the Navigation Map Page (Figure 6-83). The displayed components are relative to current aircraft altitude and track, but not to aircraft speed.

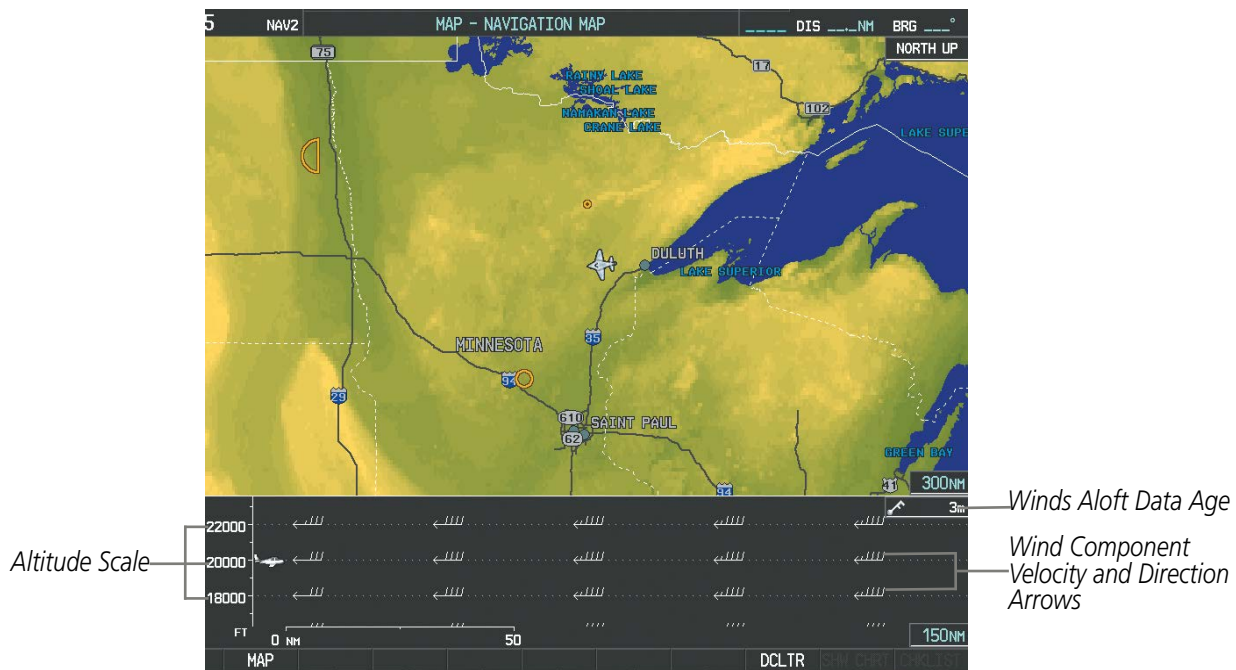

Figure 6-83 Navigation Map Page with Winds Aloft Data on Profile View

Arrows pointing to the left indicate headwind components; tailwind component arrows point to the right, as shown in Table 6-7.

Headwind Symbol	Tailwind Symbol	Headwind/Tailwind Component
None	None	Less than 5 knots
		5 knots
		10 knots
		50 knots

Table 6-7 Profile View Headwind/Tailwind Component Symbols

Showing/Hiding Profile View (containing winds aloft data)

- 1) Select the Navigation Map Page.
- 2) Press the **MAP** Softkey.
- 3) Press the **PROFILE** Softkey.

Or:

- 1) Select the Navigation Map Page
- 2) Press the **MENU** Key.
- 3) Turn the large FMS Knob to highlight 'Show Profile View' or 'Hide Profile View' (choice dependent on current state) and press the **ENT** Key.

Winds Aloft data inside the Profile View is enabled by default when the Profile View is displayed on the Navigation Map Page. This behavior can be changed on the Navigation Map Page.

Enabling/disabling winds aloft data display in Profile View:

- 1) Select the Navigation Map Page.
- 2) Press the **MENU** Key.
- 3) With Map Setup highlighted, press the **ENT** Key (Figure 6-84).
- 4) Turn the small **FMS** Knob to select the Profile Group and press the **ENT** Key (Figure 6-85).
- 5) Turn the large **FMS** Knob to select 'Profile Winds' (Figure 6-86).
- 6) Turn the small **FMS** Knob to select 'On' or 'Off'.
- 7) Push the **FMS** Knob or **CLR** Key to return to the Navigation Map Page with the changed settings.

- SYSTEM OVERVIEW
- FLIGHT INSTRUMENTS
- EIS
- AUDIO PANEL & CNS
- FLIGHT MANAGEMENT
- HAZARD AVOIDANCE
- AFCS
- ADDITIONAL FEATURES
- APPENDICES
- INDEX



Figure 6-84 Navigation Map Page Menu



Figure 6-85 Navigation Map Page Setup Menu



Figure 6-86 Navigation Map Page Setup Menu, Weather Group

PIREPS

Pilot Weather Reports (PIREPs) describe in-flight weather encountered by pilots. A PIREP may contain adverse weather conditions, such as low in-flight visibility, icing conditions, wind shear, turbulence, and type of aircraft flown. PIREPs are issued as either Routine (UA) or Urgent (UUA).

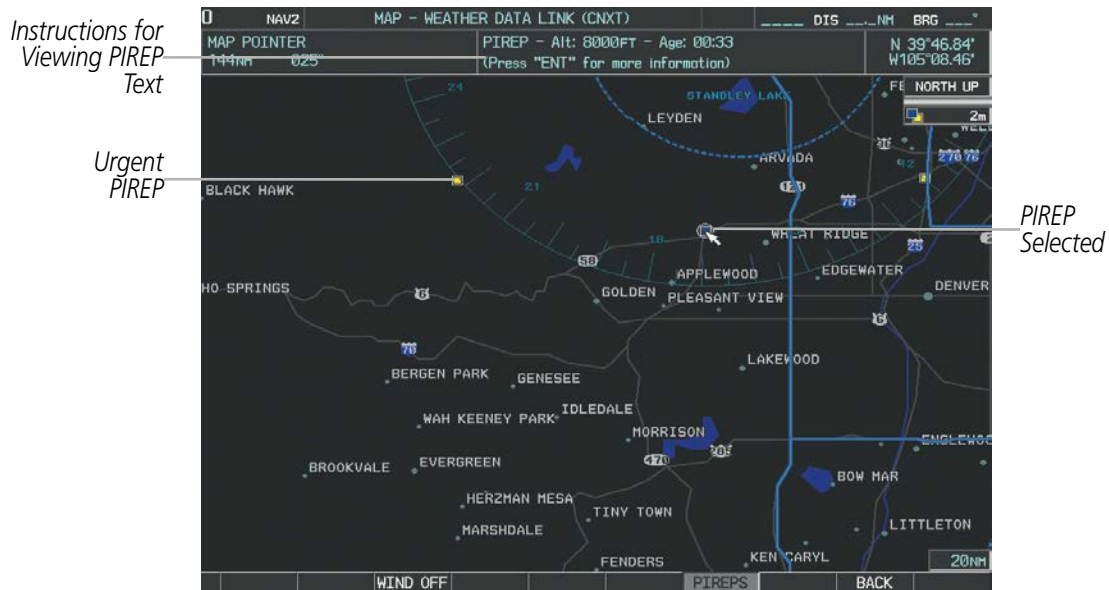

Figure 6-87 PIREPs on the Weather Data Link (CNXT) Page

Displaying PIREP text:

- 1) Select the Weather Data Link (CNXT) Page.
- 2) Press the **MORE WX** Softkey.
- 3) Press the **PIREPS** Softkey.
- 4) Push the **Joystick** and pan to the desired weather report. A gray circle will appear around the weather report when it is selected.
- 5) Press the **ENT** Key. The PIREP is first displayed in a decoded fashion, followed by the original text. Note the original text may contain additional information not found in the decoded version.
- 6) Use the **FMS** Knob or the **ENT** Key to scroll through the PIREP text.
- 7) Push the **FMS** Knob or the **CLR** Key to close the PIREP text window and return to the Weather Data Link (CNXT) Page.

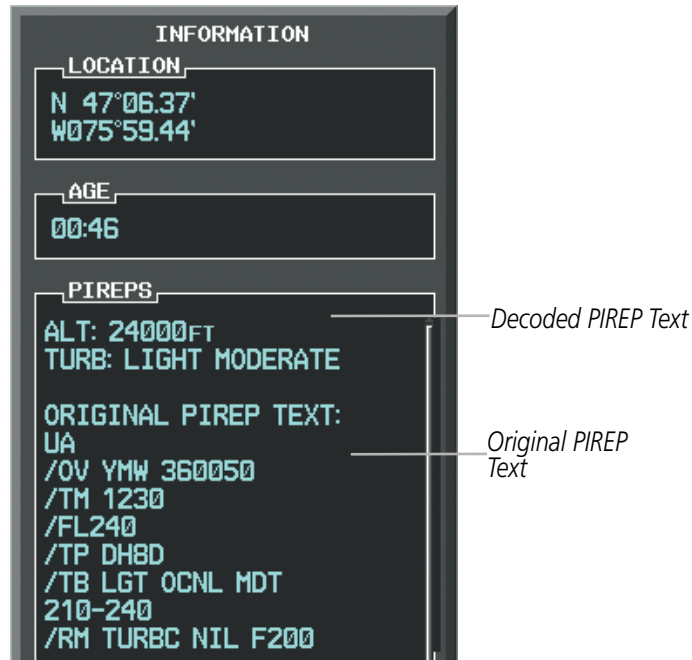

Figure 6-88 PIREP Text on the Weather Data Link (CNXT) Page

To display the PIREP legend (Figure 6-89), select the **LEGEND** Softkey when PIREPs are selected for display. The PIREP color is determined by the type (routine or urgent).

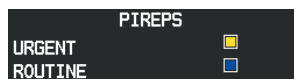



Figure 6-89 AIREPs & PIREPs Legend

TEMPORARY FLIGHT RESTRICTIONS (TFRS)

-  **NOTE:** Do not rely solely upon data link services to provide Temporary Flight Restriction (TFR) information. Always confirm TFR information through official sources such as Flight Service Stations or Air Traffic Control.
-  **NOTE:** Temporary Flight Restriction (TFR) data from Garmin Connex is only available in the United States (not including any U.S. territories.) Refer to <http://fly.garmin.com/fly-garmin/connex/worldwide-weather/> for coverage information.

The Federal Aviation Administration (FAA) issues TFRs to designate areas where flight is restricted. TFRs are issued to restrict flight for a variety of reasons including national security, law enforcement, firefighting operations, airshows, and large sporting events. TFRs may be issued at any time, and TFR data displayed on the system is only intended to supplement TFR information obtained from official sources including Flight Service Stations (FSS), and air traffic control.

The system does not display the age TFR product was assembled on the ground by the data provider is not shown; however, if TFR product is not available or has expired, the system displays 'TFR N/A' in the upper-left corner of maps on which the display of TFR information is enabled.

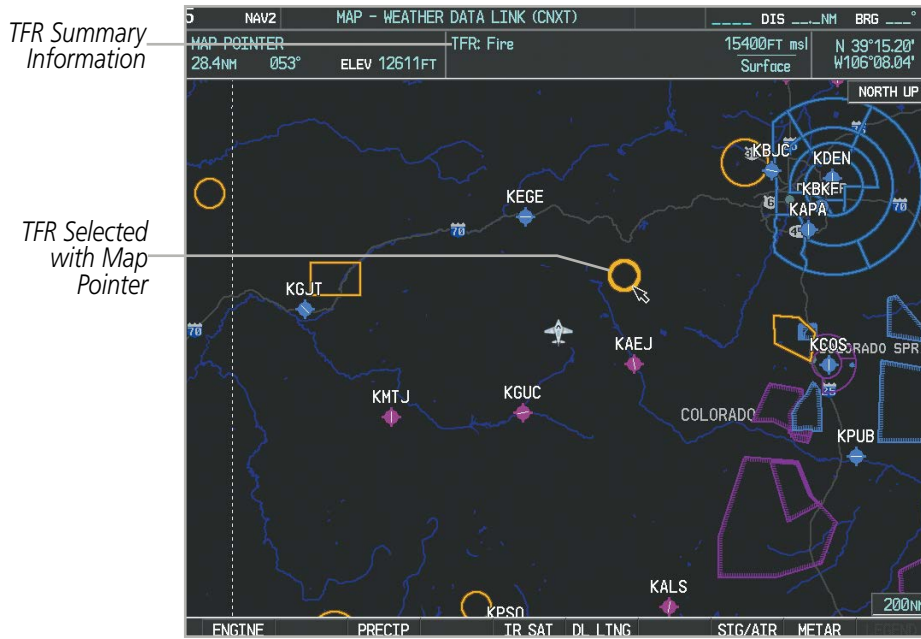

Figure 6-90 TFR Data on the Weather Data Link (CNXT) Page

Displaying TFR Data:

- 1) Select the Weather Data Link (CNXT) Page or Navigation Map Page.
- 2) Push the **Joystick** and pan the map pointer over a TFR to highlight it. The system displays TFR summary information above the map.
- 3) Press the **ENT** Key. The system displays a pop-up menu.
- 4) If necessary, turn the **FMS** Knob to select 'Review Airspaces' and press the **ENT** Key. The system displays the TFR Information window.
- 5) Push the **FMS** Knob or the **CLR** Key to remove the TFR Information window.

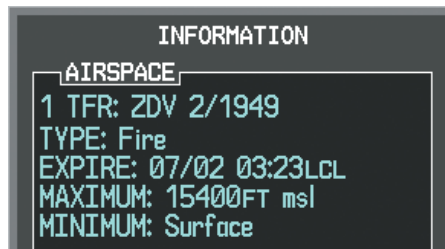

Figure 6-91 Full Text for Selected TFR

The setup menus for the Navigation Map Page control the map range settings above which TFR data is decluttered from the display. If a map range larger than the TFR product map range setting is selected, the TFR product data is removed from the map.

Maps other than the Navigation Map Page use settings based on those selected for the Navigation Map Page.

Setting up and customizing TFR data for maps on which TFR data can be displayed:

- 1) Select the Navigation Map Page.
- 2) Press the **MENU** Key.
- 3) With Map Setup highlighted, press the **ENT** Key (Figure 6-92).
- 4) Turn the small **FMS** Knob to select the Aviation Group and press the **ENT** Key (Figure 6-93).
- 5) Turn the large **FMS** Knob to scroll to the TFR product range setting (Figure 6-94).
- 6) Turn the small **FMS** Knob to scroll through options (Off, range settings).
- 7) Press the **ENT** Key to select an option.
- 8) Push the **FMS** Knob or **CLR** Key to return to the Navigation Map Page with the changed settings.

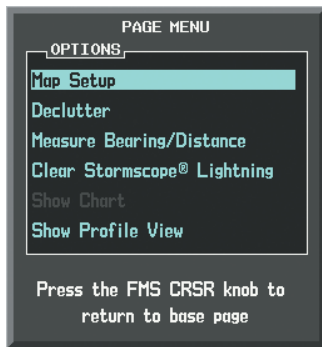

Figure 6-92 Navigation Map Page Menu

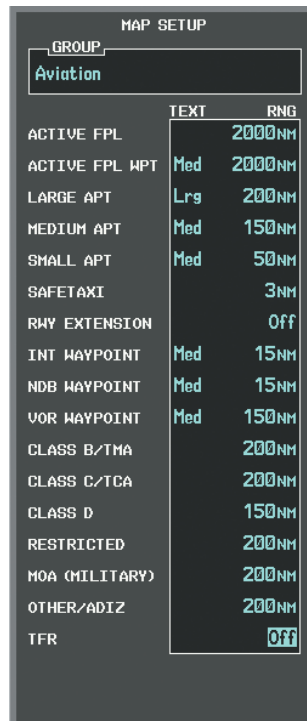

Figure 6-94 Navigation Map Page Setup Menu, Aviation Group



Figure 6-93 Navigation Map Page Setup Menu

ABNORMAL OPERATIONS

If the system cannot complete a Connex Data Request, one or more messages will appear in the request status window.

Weather Request Status Message	Description
Auto requests inhibited Send manual request to reset.	The system has disabled automatic weather data requests due to excessive errors. Automatic weather data requests have stopped. Send a manual weather data request to resume automatic updates.
Auto update retry: ## Seconds	The system will attempt another automatic weather data request after an error occurred during the previous request. Timer counts down until the next automatic request occurs.
Connex Comm Error [2]	A communications error has occurred with the GIA or optional GDL 59. The system should be serviced.
Connex Comm Error [4]	This occurs if multiple automatic weather data requests have recently failed, or the GIA or optional GDL 59 is off-line.
Connex Comm Error [5]	The Iridium or Connex networks are not accessible, or the GDL 59 is off-line or not configured. Check Iridium signal strength. If this error persists, the system should be serviced.
Connex Comm Error [6]	A communications error has occurred. If this error persists, the system should be serviced.
Connex Comm Error [7]	A weather data transfer has timed out. Check Iridium signal strength and re-send the data request.
Connex Comm Error [8]	A server error has occurred or invalid data received.
Connex Login Invalid	There is a problem with the Garmin Connex registration. Please visit www.flygarmin.com for assistance.
Connex Server Temporarily Inop	The Garmin Connex weather data server is temporarily out of service, but is expected to return to service in less than 30 minutes.
Connex Server Inop	The Garmin Connex weather data server will be out of service for at least 30 minutes.
Invalid Coverage Area	The weather data request coverage area does not contain at least one of the following: a waypoint, a flight plan, or a flight plan destination. Verify at least one of the coverage options is enabled (checked) and contains required criteria, then re-send the data request.
No Connex Subscription	The system is not currently subscribed to the Garmin Connex Weather service, or the access code is incorrect. Verify the access code. Please visit www.flygarmin.com for assistance.
Reduce Request Area	The Garmin Connex weather data request area exceeds size limits. Reduce weather coverage area and re-send data request.
Request Cancelled	The user has cancelled a Garmin Connex weather data request.
Request Failed - Try Again	The weather data request timed-out. Re-send data request.
Transfer Preempted	The optional GDL 59 is busy. Retry request later.

Table 6-8 Abnormal Garmin Connex Weather Request Status Messages

GARMIN CONNEXT WEATHER IN REVERSIONARY MODE

When the system is operating in Reversionary Mode, only those weather products which can be displayed on the PFD Inset Map will be available for display (see Table 6-5 for a list of weather products and their associated map availability).

If manual weather data requests were enabled prior to entering Reversionary Mode, no new Garmin Connex weather data can be retrieved while operating in Reversionary Mode. If automatic weather data requests were enabled prior to Reversionary Mode operation, the system will continue the automatic data requests in Reversionary Mode (provided automatic requests have not been inhibited due to a system error).

6.3 FIS-B WEATHER



WARNING: Do not use data link weather information for maneuvering in, near, or around areas of hazardous weather. Information contained within data link weather products may not accurately depict current weather conditions.



WARNING: Do not use the indicated data link weather product age to determine the age of the weather information shown by the data link weather product. Due to time delays inherent in gathering and processing weather data for data link transmission, the weather information shown by the data link weather product may be significantly older than the indicated weather product age.

The optional GDL 88 is a Universal Access Transceiver (UAT). It receives Flight Information Services - Broadcast (FIS-B) weather data from a network of UAT ground-based transceivers (GBTs). The system displays FIS-B graphical weather information and associated text on the Multi Function Display (MFD) and the Primary Flight Display (PFD) Inset Map.

FIS-B weather data reception requires the aircraft be within range and line-of-sight of an operating GBT broadcasting FIS-B weather data. Reception may be affected by factors including altitude and terrain.

Reception of FIS-B weather data occurs automatically without any pilot action. FIS-B broadcasts provide weather data in a repeating cycle which may take approximately ten minutes to transmit all available weather data. Therefore, not all available weather data may be available immediately upon initial FIS-B signal acquisition.

USING FIS-B WEATHER PRODUCTS

The primary map for viewing FIS-B Weather data is the Weather Data Link (FIS-B) Page in the Map Page Group.

Viewing the Weather Data Link (FIS-B) Page:

- 1) Turn the large **FMS** Knob to select the Map Page Group.
- 2) Turn the small **FMS** Knob to select the Weather Data Link (FIS-B, XM, or CNXT) Page.
- 3) If the page title displays a weather data link weather source other than 'FIS-B', such as 'XM' or 'CNXT', proceed to the following steps to change the data link weather source.
- 4) Press the **MENU** Key.
- 5) Turn the small **FMS** Knob to select 'Display FIS-B Weather' and press the **ENT** Key. The page title will display 'MAP - WEATHER DATA LINK (FIS-B)' to indicate FIS-B is now the selected data link weather source.

On the Weather Data Link (FIS-B) page, the pilot can enable/disable the FIS-B weather feature, which includes all FIS-B weather products and related softkeys on various maps.

Enabling/disabling the FIS-B weather feature:

- 1) Select the Weather Data Link (FIS-B) Page.
- 2) Press the **MENU** Key.
- 3) Turn the small **FMS** Knob to highlight 'Enable FIS-B Weather' or 'Disable FIS-B Weather', and press the **ENT** Key.

- SYSTEM OVERVIEW
- FLIGHT INSTRUMENTS
- EIS
- AUDIO PANEL & CNS
- FLIGHT MANAGEMENT
- HAZARD AVOIDANCE
- AFCS
- ADDITIONAL FEATURES
- APPENDICES
- INDEX

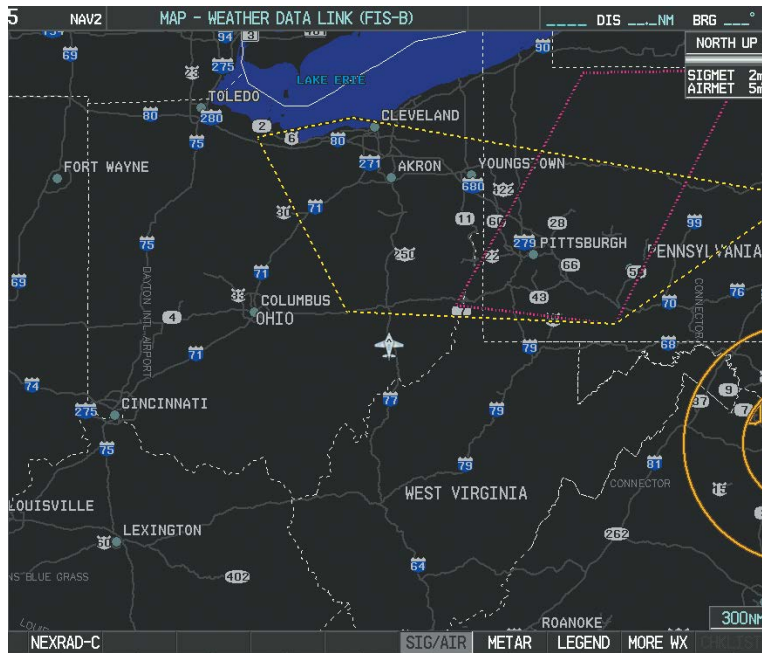

Weather Product Age Display

Figure 6-95 Weather Data Link (FIS-B) Page

When a FIS-B weather product is active on a map, the age of the data is displayed on the screen to the right of the product symbol (Figure 6-95). The age of the product is based on the time difference between when the data was assembled on the ground and the current GPS time. Weather products are transmitted at specific intervals (defined in the **Broadcast Rate** column in Table 6-9).

If for any reason, a weather product is not refreshed within the **Expiration Time** intervals (see Table 6-9), the data is considered expired and is removed from the display. This ensures that the displayed data is consistent with FIS-B broadcast data. If more than half of the expiration time has elapsed, the color of the product age displayed changes to amber. The system displays dashes instead of a product age when a product has expired. If a weather product is not available or has not been received, the system displays 'N/A' instead of a product age.

Table 6-9 shows the FIS-B weather product symbols, the expiration times, and broadcast rates. The broadcast rate represents the interval at which FIS-B GBTs broadcast new signals that may or may not contain new weather data. It does not represent the rate at which weather data is updated or new content is received by the UAT.







FIS-B Weather Product	Symbol	Expiration Time (Minutes)	Broadcast Rate (Minutes)
NEXRAD Composite (US)		30	15
NEXRAD Composite (Regional)		30	2.5
Meteorological Aerodrome Report (METARs)		90	5
Pilot Weather Report (PIREPs)		90	10
Winds Aloft (WIND)		90	10
SIGMETs/AIRMETs (SIG/AIR)		60	5
No Radar Coverage	no product image	30	2.5
Terminal Aerodrome Forecast	no product image	60	10
Temporary Flight Restriction (TFR)	no product image	60	10

Table 6-9 Weather Product Symbols and Data Timing

Table 6-10 shows which FIS-B weather products can be displayed (indicated with a '+' symbol) on specific maps.

FIS-B Weather Product	PFD Inset Map	Navigation Map Page	Weather Data Link (FIS-B) Page	Weather Information Page	AUX - Trip Planning Page	AUX - Video Page	Nearest Page Group	Flight Plan Pages
NEXRAD	+	+	+		+	+	+	+
METARs	+	+	+	+	+	+	+	+
PIREPs			+	+				
No Radar Coverage	+	+	+		+	+	+	
SIGMETs/AIRMETs (SIG/AIR)			+					
TAFs				+				
TFRs	+	+	+	+	+	+	+	+
Winds Aloft* (WIND)		+	+					

* Winds Aloft information appears inside Profile View window on the Navigation Map Page.

Table 6-10 FIS-B Weather Product Display Maps

Softkeys control the display of weather information on most MFD pages and the PFD Inset Map (Figure 6-96) shows the weather product softkeys for the Weather Data Link (FIS-B) Page). When a weather product is enabled for display, the corresponding softkey label changes to gray.

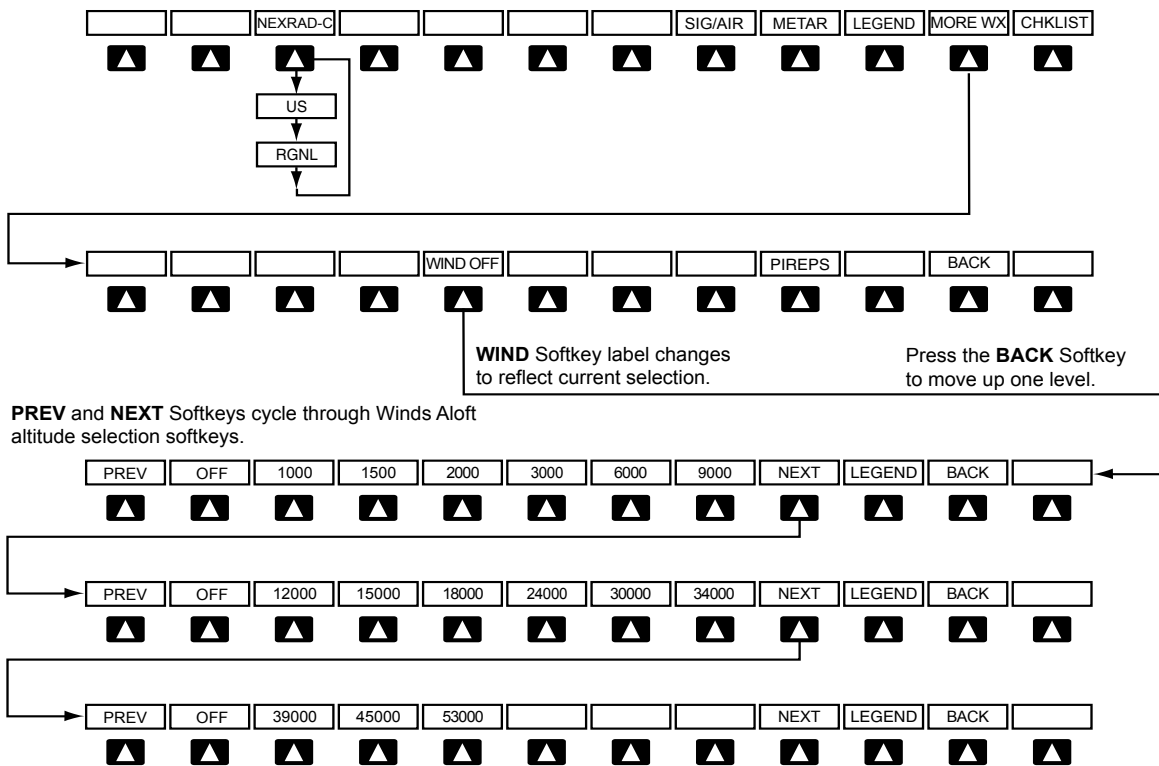

Figure 6-96 Weather Data Link (FIS-B) Weather Product Softkeys

Maps besides the Weather Data Link (FIS-B) Page use settings based on those selected for the Navigation Map Page.

Setting up and customizing FIS-B weather data for the Navigation Map Page:

- 1) Select the Navigation Map Page.
- 2) Press the **MENU** Key.
- 3) With 'Map Setup' highlighted, press the **ENT** Key (Figure 6-97).
- 4) Turn the small **FMS** Knob to select the 'Weather' Group and press the **ENT** Key (Figure 6-98).
- 5) Turn the large **FMS** Knob or press the **ENT** Key to scroll through product selections (Figure 6-99).
- 6) Turn the small **FMS** Knob to scroll through options for each product (ON/OFF, range settings).
- 7) Press the **ENT** Key to select an option.
- 8) Push the **FMS** Knob or **CLR** Key to return to the Navigation Map Page with the changed settings.

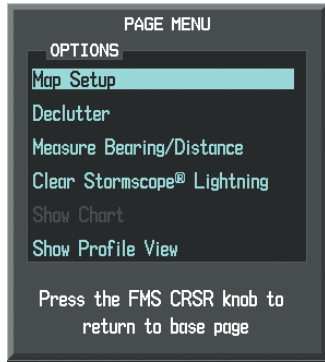

Figure 6-97 Navigation Map Page Menu



Figure 6-98 Navigation Map Page Setup Menu

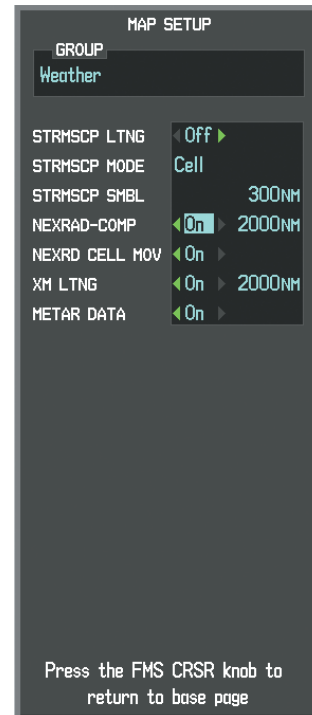

Figure 6-99 Navigation Map Page Setup Menu, Weather Group

The setup menus for the Navigation Map Page and the Weather Data Link (FIS-B) Page control the map range settings above which weather products data are decluttered from the display. If a map range larger than the weather product map range setting is selected, the weather product data is removed from the map. The menus also provide a means in addition to the softkeys for enabling/disabling display of weather products.

Setting up and customizing the Weather Data Link (FIS-B) Page:

- 1) Select the Weather Data Link (FIS-B) Page.
- 2) Press the **MENU** Key.
- 3) With 'Weather Setup' highlighted, press the **ENT** Key (Figure 6-100).
- 4) Turn the small **FMS** Knob to select 'PRODUCT GROUP 1', and press the **ENT** Key (Figure 6-101).
- 5) Turn the large **FMS** Knob or press the **ENT** Key to scroll through product selections.
- 6) Turn the small **FMS** Knob to scroll through options for each product (ON/OFF, range settings, etc.).
- 7) Press the **ENT** Key to select an option.
- 8) Push the **FMS** Knob or **CLR** Key to return to the Weather Data Link (FIS-B) Page with the changed settings.

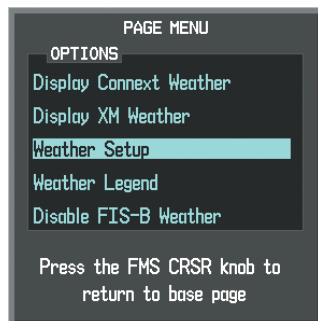

Figure 6-100 Weather Data Link (FIS-B) Page Menu

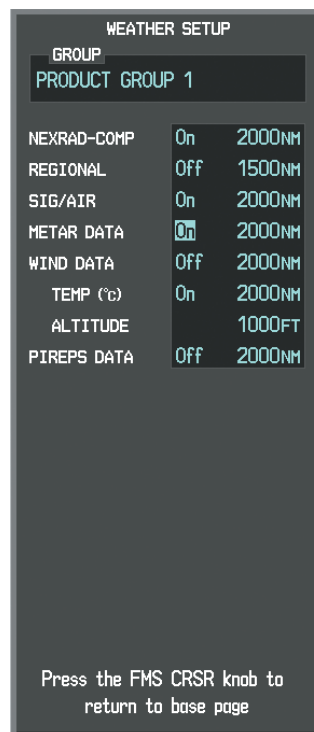

Figure 6-101 Weather Data Link (FIS-B) Page Setup Menu

Restoring default Weather Data Link (FIS-B) Page settings:

- 1) Select the Weather Data Link (FIS-B) Page.
- 2) Press the **MENU** Key.
- 3) With 'Weather Setup' highlighted, press the **ENT** Key.
- 4) Turn the small **FMS** Knob to select 'PRODUCT GROUP 1', and press the **ENT** Key (Figure 6-101).
- 5) If restoring an individual weather product setting to its default value, turn the large **FMS** Knob to highlight the desired field to restore.
- 6) Press the **MENU** Key.
- 7) Turn the large **FMS** Knob if needed to highlight 'Restore Selection Default' (to restore only the highlighted field) or 'Restore All Defaults' (to restore all products within the selected product group to their default settings), and press the **ENT** Key.

If multiple data link weather services are installed, customizing the display settings for the corresponding weather products shown in Table 6-11 will result in identical settings for all services.

SiriusXM Weather Product and Softkey	Garmin Connex Weather Product	FIS-B Weather Product
Next-generation Radar (NEXRAD) and No Radar Coverage	Precipitation (PRECIP) and No Radar Coverage	Next-generation Radar (NEXRAD) and No Radar Coverage
Cloud Top (CLD TOP)	Infrared Satellite (IR SAT)	Not Available
SiriusXM Lightning (XM LTNG)	Garmin Connex Data Link Lightning (DL LTNG)	Not Available
SIGMETs/AIRMETs (SIG/AIR)	SIGMETs/AIRMETs (SIG/AIR)	SIGMETs/AIRMETs (SIG/AIR)
Meteorological Aerodrome Report (METARs)	Meteorological Aerodrome Report (METARs)	Meteorological Aerodrome Report (METARs)
Winds Aloft (WIND)	Winds Aloft (WIND)	Winds Aloft (WIND)
Pilot Weather Report (PIREPs)	Pilot Weather Report (PIREPs)	Pilot Weather Report (PIREPs)

Table 6-11 Weather Data Link Map Settings Shared for Multiple Weather Data Link Sources

When a FIS-B weather product is enabled for display on the PFD Inset Map, the weather product information box (with the product icon and age) can be displayed inside the PFD Inset Map.

Displaying/removing the weather product information box on the PFD Inset Map:

- 1) On the PFD, press the **INSET** Softkey.
- 2) Press the **WX LGND** Softkey.
- 3) To remove the weather product information box, press the **WX LGND** Softkey again.

Each active weather product has an associated legend which can be displayed on the Weather Data Link (FIS-B) Page. A weather product legend can also be displayed on the Navigation Map Page for active FIS-B weather products displayed on that page.

Viewing legends for displayed weather products on the Weather Data Link (FIS-B) Page:

- 1) Select the Weather Data Link (FIS-B) Page.
- 2) Press the **LEGEND** Softkey to display the legends for the displayed weather products.
Or:
 - a) Press the **MENU** Key.
 - b) Select 'Weather Legend' and press the **ENT** Key.
- 3) To remove the Legend Window, press the **LEGEND** Softkey, the **ENT** or the **CLR** Key, or push the **FMS** Knob.

images--gathered from each NEXRAD site--differ in age, and are always older than the displayed NEXRAD weather product age. The data provider then sends the NEXRAD data to the FIS-B GBTs, which transmit this information during the next designated broadcast time for the NEXRAD weather product.

Because of the time required to detect, assemble, and distribute the NEXRAD weather product, the displayed weather information contained within the product may be significantly older than the current radar synopsis and may not depict the current weather conditions. NEXRAD information should never be used as a basis for maneuvering in, near, or around areas of hazardous weather regardless of the information it contains.

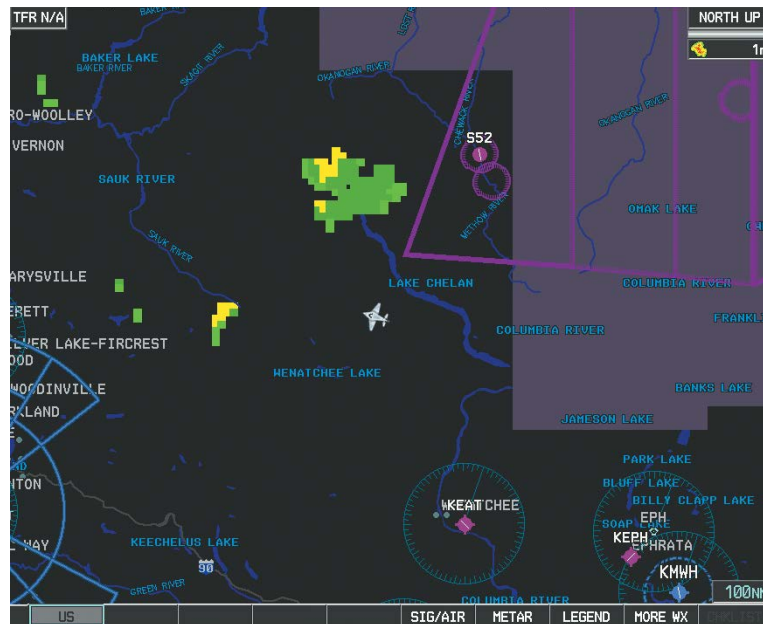

Figure 6-103 NEXRAD Weather Product on the Weather Data Link (FIS-B) Page

The FIS-B NEXRAD weather product may be displayed for a region around the GBT (higher resolution, updated more frequently) or for across the continental United States (lower resolution, updated less frequently). The pilot can choose which type of NEXRAD weather product is displayed.

Displaying the NEXRAD weather product::

- 1) Press the **MAP** Softkey (for the PFD Inset Map, press the **INSET** Softkey). This step is not necessary on the Weather Data Link (FIS-B) Page.
- 2) Press the **NEXRAD-C** Softkey. This softkey becomes the **US** Softkey. A mosaic of NEXRAD data for the continental United States (CONUS) is displayed.
- 3) To display the regional version of the NEXRAD weather product, press the **US** Softkey. Softkey becomes the **RGNL** Softkey.
- 4) To remove the NEXRAD weather product, press the **RGNL** Softkey. Softkey becomes the **NEXRAD-C** Softkey.

The regional NEXRAD weather product coverage area varies, as it is determined by the data received from ground-based sources. When the regional NEXRAD weather product is enabled, a white hashed boundary rectangle encloses this area to indicate the geographic limits of the regional NEXRAD coverage being displayed. The system shows composite radar data from all available NEXRAD sites inside of this boundary area.

If the continental United States version of the NEXRAD weather product is shown (**US** Softkey enabled), the coverage boundary is not shown on the map.

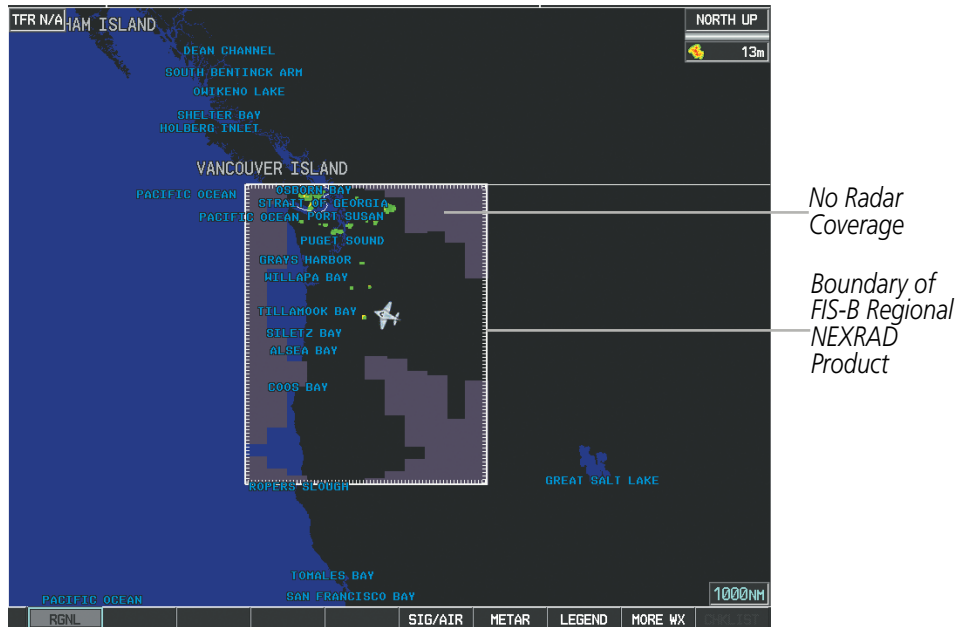

Figure 6-104 Regional NEXRAD on the Weather Data Link (FIS-B) Page

This data is composed of the maximum reflectivity from the individual radar sweeps. The display of the information is color-coded to indicate the weather severity level. All weather product legends can be viewed on the Weather Data Link (FIS-B) Page. For the NEXRAD legend (Figure 6-105), press the **LEGEND** Softkey when the NEXRAD weather product is enabled.

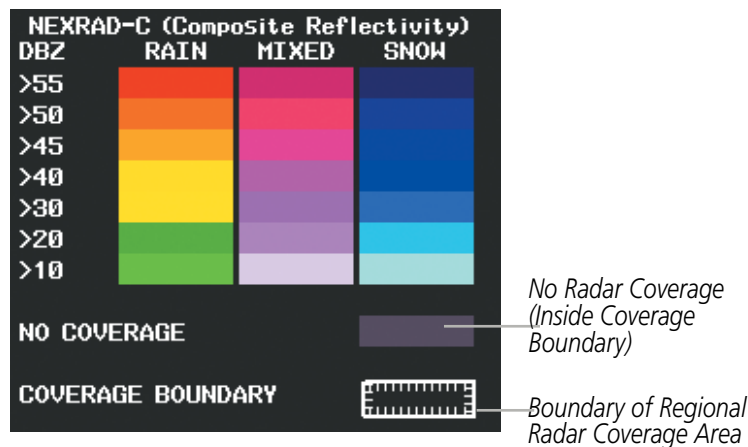

Figure 6-105 NEXRAD Weather Product Legend

The display of no radar coverage is enabled when NEXRAD is selected for display. Areas where radar data is not currently available, has not yet been received, or is not being collected are indicated in gray shade of purple.



NOTE: If the system has not received all available NEXRAD weather data (such as during initial FIS-B signal acquisition or in areas of marginal or poor signal reception), the system may display areas of no radar coverage which are subsequently removed as radar data is received. It may take up to approximately ten minutes to receive all FIS-B data, when adequate reception is available.

REFLECTIVITY

Reflectivity is the amount of transmitted power returned to the radar receiver. Colors on the NEXRAD display are directly correlative to the level of detected reflectivity. Reflectivity as it relates to hazardous weather can be very complex.

The role of radar is essentially to detect moisture in the atmosphere. Simply put, certain types of weather reflect radar better than others. The intensity of a radar reflection is not necessarily an indication of the weather hazard level. For instance, wet hail returns a strong radar reflection, while dry hail does not. Both wet and dry hail can be extremely hazardous.

The different NEXRAD echo intensities are measured in decibels (dB) relative to reflectivity (Z). NEXRAD measures the radar reflectivity ratio, or the energy reflected *back to* the radar receiver (designated by the letter Z). The value of Z increases as the returned signal strength increases.

NEXRAD LIMITATIONS

NEXRAD radar images may have certain limitations:

- At a map range of 30 nm or less, individual blocks of NEXRAD weather data are viewable. For the regional version of the NEXRAD weather product, each block is 1.5 nm wide by 1 nm tall. For the continental United States version of the NEXRAD weather product, each block is 7.5 nm wide by 5 nm wide.
- The continental US version of the NEXRAD weather product is not available above 60° of latitude.
- Precipitation occurring below the radar beam will not be detected.

The following may cause abnormalities in displayed NEXRAD radar images:

- Ground clutter
- Strokes and spurious radar data
- Sun strokes (when the radar antenna points directly at the sun)
- Interference from buildings or mountains, which may cause shadows
- Metallic dust (chaff) from military aircraft, which can cause alterations in radar scans

SIGMETS AND AIRMETS

SIGMETs (SIGnificant METeorological Information) and AIRMETs (AIRmen's METeorological Information) are issued for potentially hazardous weather. A Convective SIGMET is issued for hazardous convective weather such as severe or widespread thunderstorms. A localized SIGMET can be displayed when significant weather conditions are not widespread.

The entire SIGMET or AIRMET is shown as long as any portion of it is issued within the selected coverage area of the Connex Data Request.

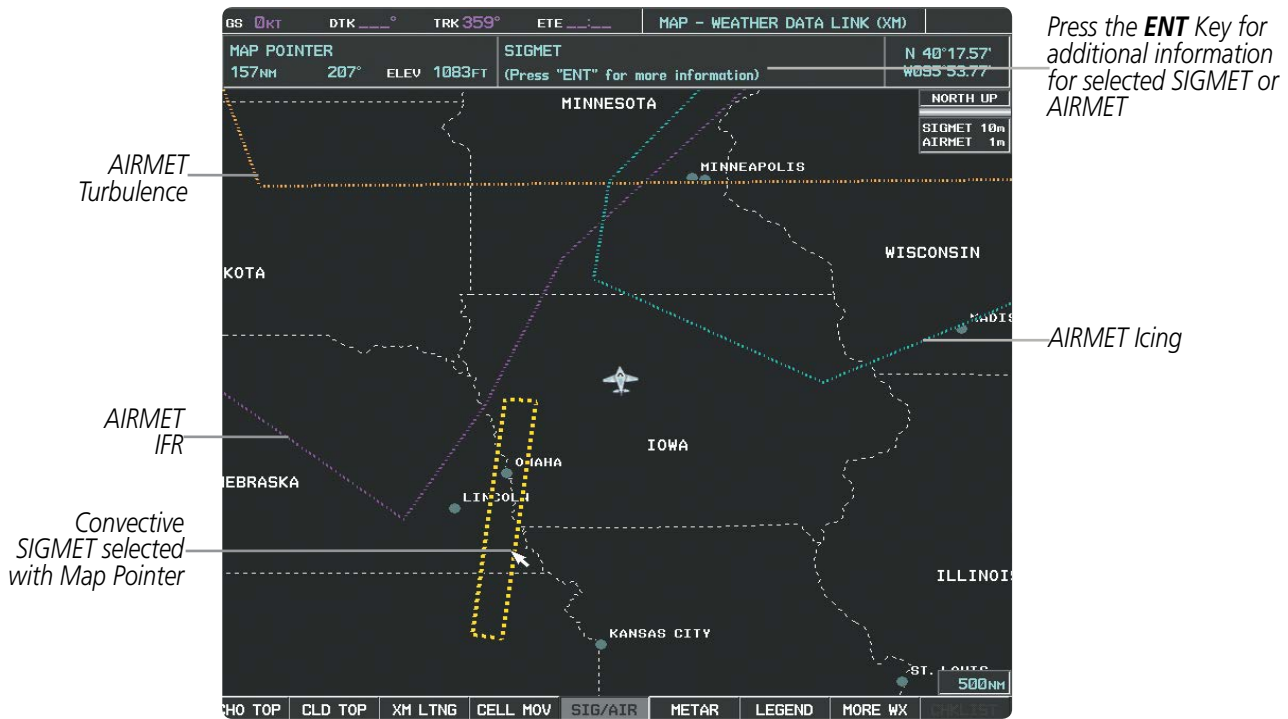

Figure 6-106 SIGMET/AIRMET Data

Displaying SIGMETs and AIRMETs:

- 1) Select the Weather Data Link (FIS-B) Page.
- 2) Press the **SIG/AIR** Softkey.
- 3) To view the text of the SIGMET or AIRMET, press the **Joystick** and move the Map Pointer over the icon.
- 4) Press the **ENT** key. Figure 6-107 shows sample SIGMET text.

To display the SIGMET and AIRMET legend (Figure 6-108), press the **LEGEND** Softkey when SIGMETs and AIRMETs are selected for display.

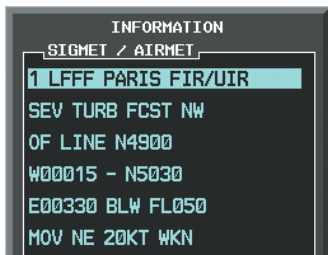

Figure 6-107 Sample SIGMET Text



Figure 6-108 SIGMET/AIRMET Legend

METARS AND TAFS

NOTE: Atmospheric pressure is reported in inches of mercury (in Hg). Temperatures are reported in Celsius.

NOTE: The system will begin to display METAR flags as it receives reports; however it may take approximately ten minutes for all available METAR and TAF data to be received over a FIS-B broadcast.

Aviation Routine Weather Reports or METARs typically contain current information about the temperature, dewpoint, wind, precipitation, cloud cover, cloud heights, visibility, and barometric pressure at an airport or observation station. They can also contain information on precipitation amounts, lightning, and other critical data. METARs reflect routine hourly observations. An Aviation Selected Special Report or SPECI includes the code “SPECI” in the report, and may be issued if critical information has changed after the issuance of a METAR. The system displays colored flags at airports with report(s) available.

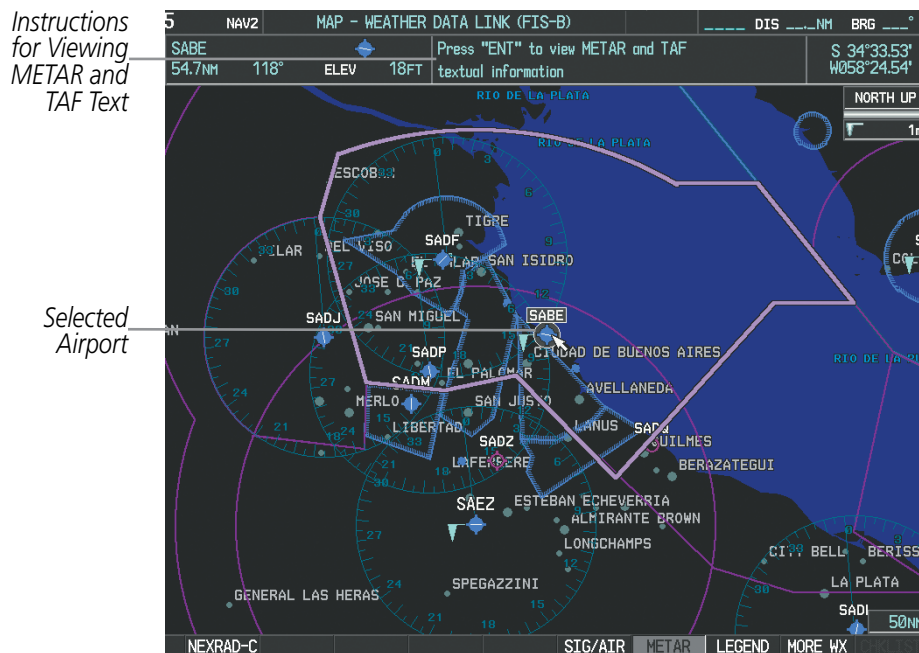

Figure 6-109 METAR Flags on the Weather Data Link (FIS-B) Page

TAFs (Terminal Aerodrome Forecasts) are predications of expected weather conditions for an area within five statute miles of the center of an airport’s runway complex. The National Weather Service issues scheduled TAFs four times each day, and additional amended TAFs if conditions warrant. TAFs typically span a forecast period of 24 hours, but may be scheduled for a longer period. TAFs may include forecast wind, visibility, significant weather phenomena, and sky conditions using METAR codes.

METAR and TAF text are available on the Weather Information Page. METAR data is displayed first in a decoded fashion, followed by the original text. Note the original text may contain additional information not found in the decoded version. TAF information, when available, appears only in its original text.

Displaying METAR and TAF text:

- 1) On the Weather Data Link (FIS-B) Page, press the **METAR** Softkey.
- 2) Push the **Joystick** and pan to the desired airport.
- 3) Press the **ENT** Key. The Weather Information Page is shown with METAR and TAF text.
- 4) Use the **FMS** Knob or the **ENT** Key to scroll through the METAR and TAF text. METAR text must be completely scrolled through before scrolling through the TAF text.
- 5) Push the **FMS** Knob or the **CLR** Key to return to the Weather Data Link (FIS-B) Page.

Or:

- 1) Select the Weather Information Page.
 - a) Turn the large **FMS** Knob to select the Waypoint Page Group.
 - b) Press the **WX** Softkey to select the Weather Information Page.
- 2) Push the **FMS** Knob to display the cursor.
- 3) Use the **FMS** Knob to enter the desired airport and press the **ENT** Key.
- 4) Use the **FMS** Knob or the **ENT** Key to scroll through the METAR and TAF text. Note that the METAR text must be completely scrolled through before scrolling through the TAF text.



Figure 6-110 METAR and TAF Text on the Weather Information Page

Original METAR text is also accessible while panning the map cursor over a METAR flag on any map page on which a METAR is displayed. The METAR text is shown in a box near the METAR flag.

In addition, METAR flags and their associated text are displayed on the Active Flight Plan Page on the MFD. METAR flags appear next to waypoints in the flight plan with an associated METAR. A solid METAR flag indicates the METAR observations are available for specific waypoint; a hollow METAR flag indicates an off-route METAR is available near the waypoint.

Displaying original METAR text on the Active Flight Plan Page:

- 1) Select the Active Flight Plan Page on the MFD.
- 2) Push the **FMS** Knob to activate the cursor.
- 3) Turn the large **FMS** Knob to highlight the desired waypoint. The METAR text will appear in the 'SELECTED WAYPOINT WEATHER' window below.
- 4) When finished, push the **FMS** Knob to remove the cursor or press the **FPL** Key to exit the Active Flight Plan Page.

To display the METAR legend on the Weather Data Link (FIS-B) Page (Figure 6-111), press the **LEGEND** Softkey when METARs are selected for display.

The METAR flag color is determined by the information in the METAR text. The system displays a gray METAR flag when the METAR text does not contain enough information to determine the METAR category (e.g., VFR, IFR).



Figure 6-111 METAR Legend

WINDS ALOFT

The Winds Aloft weather product (Figure 6-105) shows the predicted wind speed and direction at selected altitudes. Winds aloft are available in various altitudes between 1,000 feet and 53,000 feet MSL.

Displaying Winds Aloft information:

- 1) Select the Weather Data Link (FIS-B) Page.
- 2) Press the **MORE WX** Softkey.
- 3) Press the **WIND OFF** Softkey.
- 4) Press the softkey for the desired altitude. Press the **NEXT** or **PREV** Softkey to cycle through the altitude softkeys. The **WIND** Softkey label changes to reflect the altitude selected.

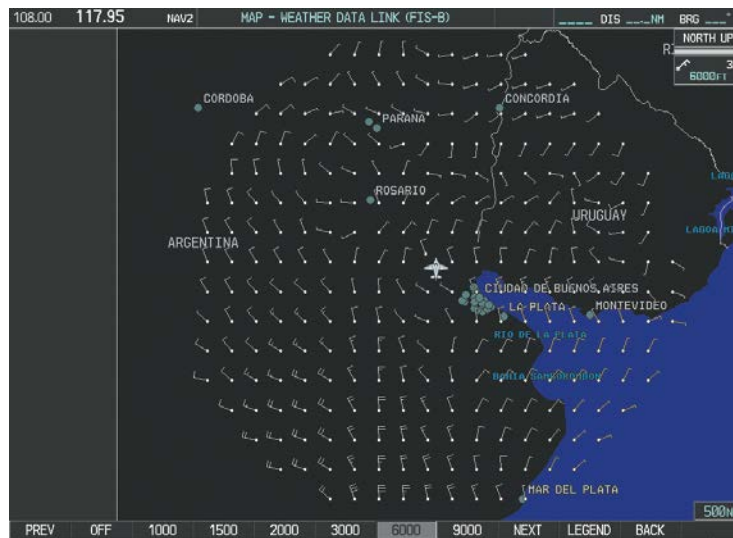

Figure 6-112 Winds Aloft at 6,000 Feet

To display the Winds Aloft legend (Figure 6-113), select the **LEGEND** Softkey when Winds Aloft is selected for display.

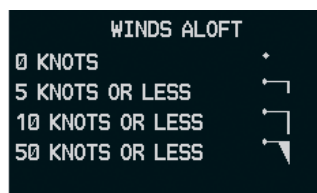

Figure 6-113 Winds Aloft Data with Legend

Headwind and tailwind components aloft are available inside the Profile View on the Navigation Map Page (Figure 6-114). The displayed components are relative to current aircraft altitude and track, but not to aircraft speed.

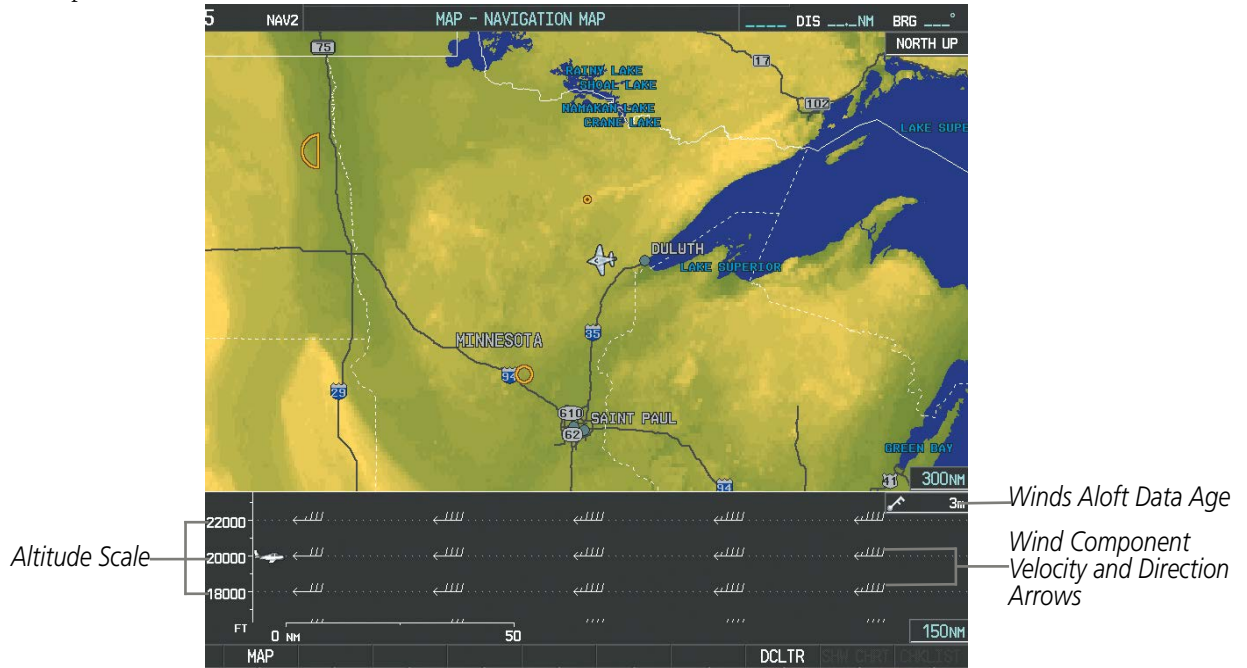

Figure 6-114 Navigation Map Page with Winds Aloft Data on Profile View

Arrows pointing to the left indicate headwind components; tailwind component arrows point to the right, as shown in Table 6-12.

Headwind Symbol	Tailwind Symbol	Headwind/Tailwind Component
None	None	Less than 5 knots
←	→	5 knots
←	→	10 knots
←	→	50 knots

Table 6-12 Profile View Headwind/Tailwind Component Symbols

Enabling/disabling profile view (containing winds aloft data)

- 1) Select the Navigation Map Page.
 - 2) Press the **PROFILE** Softkey.
- Or:**
- 1) Press the **MENU** Key.
 - 2) Turn the large FMS Knob to highlight 'Show Profile View' or 'Hide Profile View' (choice dependent on current state) and press the **ENT** Key.

Winds Aloft data inside the Profile View is enabled by default when the Profile View is displayed on the Navigation Map Page. This behavior can be changed on the Navigation Map Page.

Enabling/disabling winds aloft data display in Profile View:

- 1) Select the Navigation Map Page.
- 2) Press the **MENU** Key.
- 3) With Map Setup highlighted, press the **ENT** Key (Figure 6-115).
- 4) Turn the small **FMS** Knob to select the Profile Group and press the **ENT** Key (Figure 6-116).
- 5) Turn the large **FMS** Knob to select 'Profile Winds' (Figure 6-117).
- 6) Turn the small **FMS** Knob to select 'On' or 'Off'.
- 7) Push the **FMS** Knob or **CLR** Key to return to the Navigation Map Page with the changed settings.



Figure 6-115 Navigation Map Page Menu



Figure 6-116 Navigation Map Page Setup Menu



Figure 6-117 Navigation Map Page Setup Menu, Weather Group

PIREPS

Pilot Weather Reports (PIREPs) describe in-flight weather encountered by pilots. A PIREP may contain adverse weather conditions, such as low in-flight visibility, icing conditions, wind shear, turbulence, and type of aircraft flown. PIREPs are issued as either Routine (UA) or Urgent (UUA).

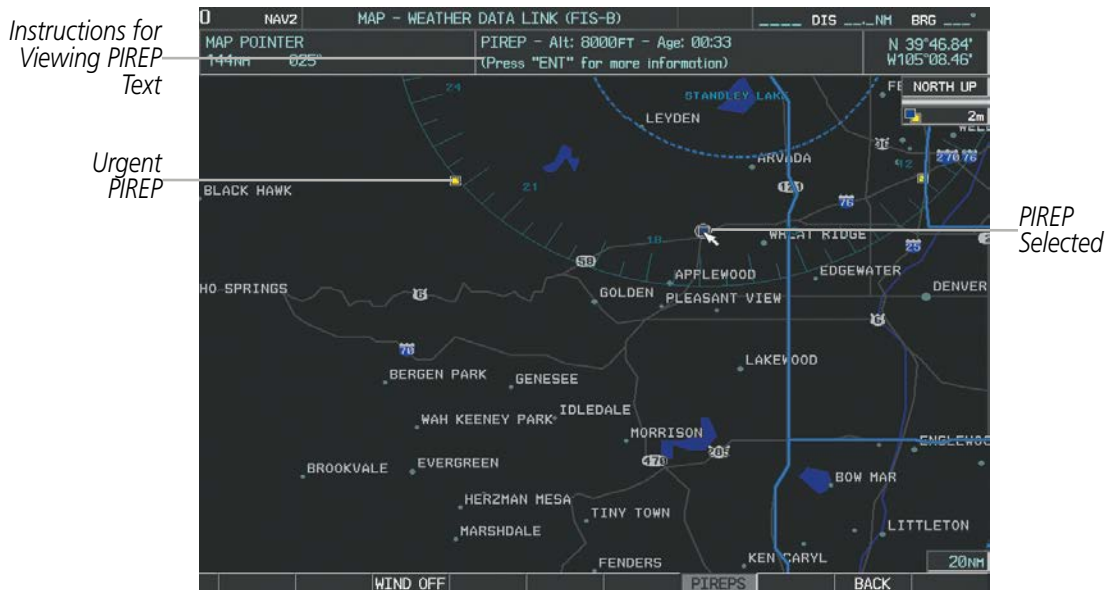

Figure 6-118 PIREPs on the Weather Data Link (CNXT) Page

Displaying PIREP text:

- 1) Select the Weather Data Link (FIS-B) Page.
- 2) Press the **MORE WX** Softkey.
- 3) Press the **PIREPS** Softkey.
- 4) Push the **Joystick** and pan to the desired weather report. A gray circle will appear around the weather report when it is selected.
- 5) Press the **ENT** Key. The PIREP text is first displayed in a decoded fashion, followed by the original text. Note the original text may contain additional information not shown in the decoded version.
- 6) Use the **FMS** Knob or the **ENT** Key to scroll through the PIREP text.
- 7) Push the **FMS** Knob or the **CLR** Key to close the PIREP text window and return to the Weather Data Link (FIS-B) Page.

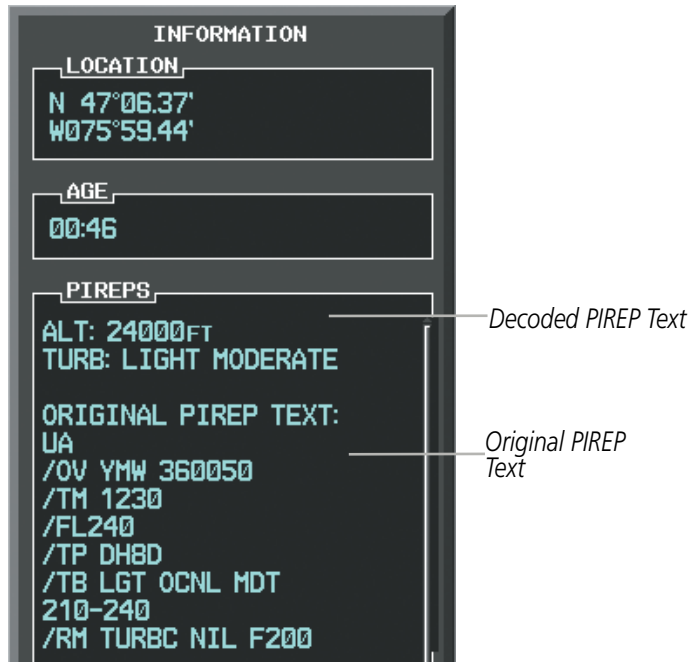

Figure 6-119 PIREP Text on the Weather Data Link (CNXT) Page

To display the PIREP legend (Figure 6-120), press the **LEGEND** Softkey when PIREPs are selected for display. The PIREP color is determined by the report type (routine or urgent).



Figure 6-120 AIREPs & PIREPs Legend

TFRS



NOTE: Do not rely solely upon data link services to provide Temporary Flight Restriction (TFR) information. Always confirm TFR information through official sources such as Flight Service Stations or Air Traffic Control.

In the United States, the Federal Aviation Administration (FAA) issues Temporary Flight Restrictions (TFRs) to designate areas where flight is restricted. TFRs are issued to restrict flight for a variety of reasons including national security, law enforcement, natural disasters, airshows, and large sporting events. TFRs may be issued at any time, and TFR data displayed is only intended to supplement official TFR information obtained from Flight Service Stations (FSS), and air traffic control.

The age of TFR data is not shown; however, if TFR data is not available or has expired, the system displays 'TFR N/A' in the upper-left corner of maps on which TFRs can be displayed.

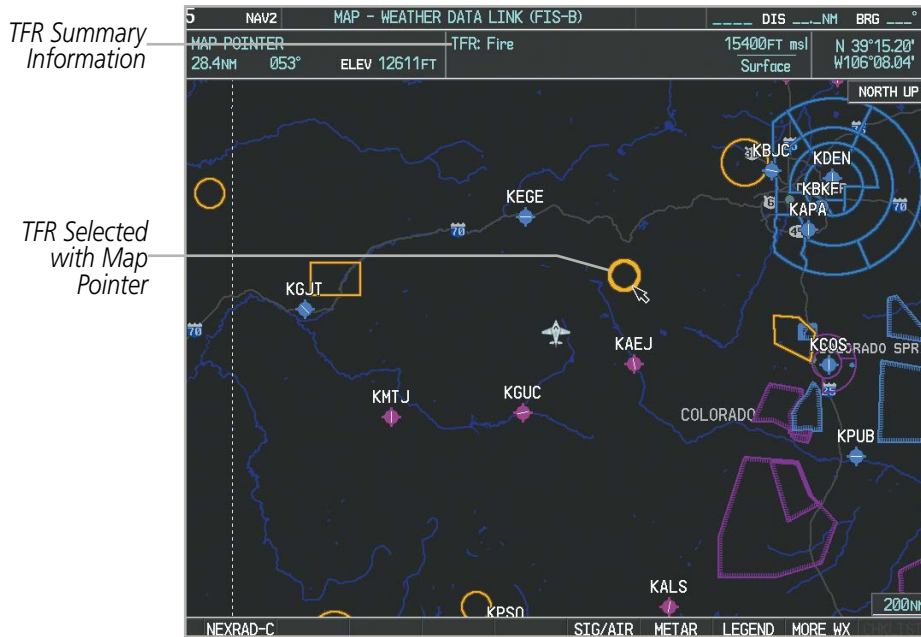

Figure 6-121 TFR Data on the Weather Data Link (FIS-B) Page

Displaying TFR Data:

- 1) Select the Weather Data Link (FIS-B) Page or Navigation Map Page.
- 2) Push the **Joystick** and pan the map pointer over a TFR to highlight it. The system displays TFR summary information above the map.
- 3) Press the **ENT** Key. The system displays a pop-up menu.
- 4) If necessary, turn the **FMS** Knob to select 'Review Airspaces' and press the **ENT** Key. The system displays the TFR Information window.
- 5) Push the **FMS** Knob or the **CLR** Key to remove the TFR Information window.

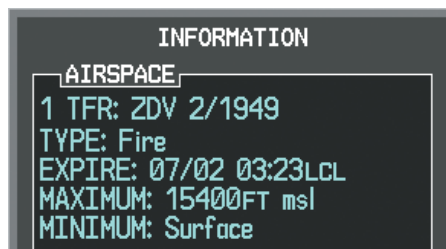

Figure 6-122 Full Text for Selected TFR

The setup menus for the Navigation Map Page control the map range settings above which TFR data is decluttered from the display. If a map range larger than the TFR product map range setting is selected, the TFR product data is removed from the map.

Maps other than the Navigation Map Page use settings based on those selected for the Navigation Map Page.

Setting up and customizing TFR data for maps on which TFR data can be displayed:

- 1) Select the Navigation Map Page.
- 2) Press the **MENU** Key.
- 3) With Map Setup highlighted, press the **ENT** Key (Figure 6-123).
- 4) Turn the small **FMS** Knob to select the Aviation Group and press the **ENT** Key (Figure 6-124).
- 5) Turn the large **FMS** Knob to scroll to the TFR product range setting (Figure 6-125).
- 6) Turn the small **FMS** Knob to scroll through options (Off, range settings).
- 7) Press the **ENT** Key to select an option.
- 8) Push the **FMS** Knob or **CLR** Key to return to the Navigation Map Page with the changed settings.

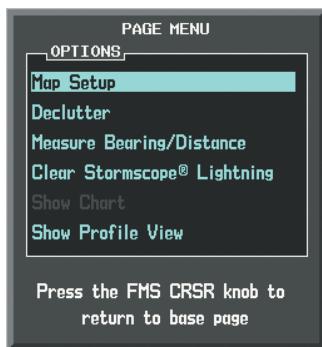

Figure 6-123 Navigation Map Page Menu

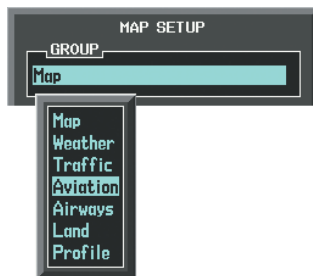

Figure 6-124 Navigation Map Page Setup Menu

	TEXT	RNG
ACTIVE FPL		2000NM
ACTIVE FPL WPT	Med	2000NM
LARGE APT	Lrg	200NM
MEDIUM APT	Med	150NM
SMALL APT	Med	50NM
SAFETAXI		3NM
RWY EXTENSION		Off
INT WAYPOINT	Med	15NM
NDB WAYPOINT	Med	15NM
VOR WAYPOINT	Med	150NM
CLASS B/TMA		200NM
CLASS C/TCA		200NM
CLASS D		150NM
RESTRICTED		200NM
MOA (MILITARY)		200NM
OTHER/ADIZ		200NM
TFR		Off

Figure 6-125 Navigation Map Page Setup Menu, Aviation Group

FIS-B WEATHER STATUS

Additional information about the status of FIS-B weather products is available on the AUX - ADS-B Status Page.

Viewing FIS-B status:

- 1) Turn the large **FMS** Knob to select the AUX Page Group.
- 2) Turn the small **FMS** Knob to select the AUX - ADS-B Status Page.

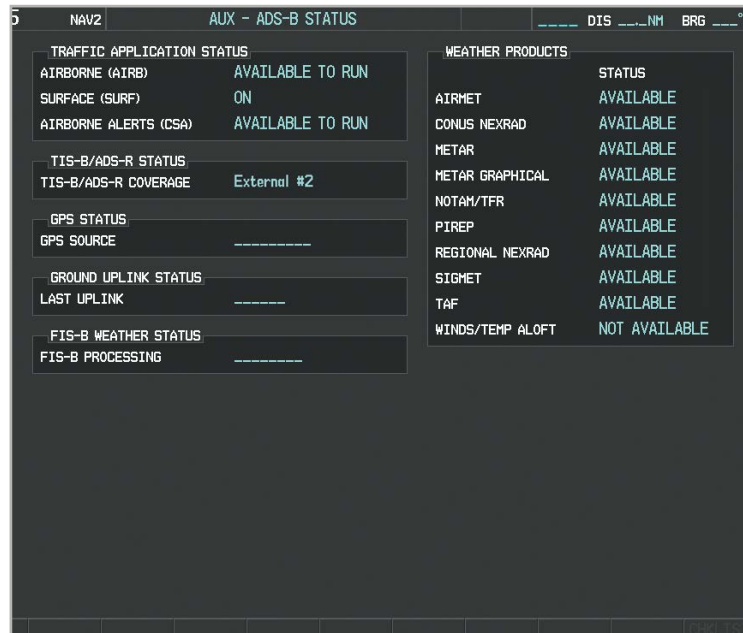

Figure 6-126 Viewing FIS-B Weather Status on ADS-B Status Page

ADS-B Status Page Item	Status Message	Description
FIS-B Weather Status: FIS-B Processing	ENABLED	The FIS-B weather feature is enabled to process and display FIS-B weather products.
	DISABLED	The FIS-B weather feature is disabled.
	-----	No data received from the GDL 88 UAT.
Weather Products: AIRMET CONUS NEXRAD METAR METAR GRAPHICAL NOTAM/TFR PIREP REGIONAL NEXRAD SIGMET TAF WINDS/TEMPS ALOFT	AVAILABLE	FIS-B weather data is available for display for the weather product.
	NOT AVAILABLE	FIS-B weather data is not available for the weather product, and/or the system is not receiving the FIS-B weather service.
	AWAITING DATA	The system is receiving the FIS-B weather service, and is waiting to receive the weather product from the FIS-B data broadcast.

Table 6-13 AUX-ADS-B Status Page Messages for FIS-B Weather

6.4 LIGHTNING DETECTION SYSTEM



WARNING: Do not rely on information from a lightning detection system display as the sole basis for hazardous weather avoidance. Range limitations and interference may cause the system to display inaccurate or incomplete information. Refer to documentation from the lightning detection system manufacturer for detailed information about the system.



NOTE: Lightning information from data link services such as SiriusXM Weather or Garmin Connex cannot be displayed at the same time as on-board lightning detection system data is selected for display.

The following pages can display on-board lightning detection system data:

- Stormscope Page
- Navigation Map
- AUX - Video Page
- AUX - Trip Planning Page
- Nearest Pages

To display lightning data on the Navigation Map, AUX - Trip Planning Page, or any of the Nearest Pages, select the **MAP** Softkey, then select the **STRMSCP** Softkey. These pages can also display cell or strike data using the lightning strike symbols shown in Table 6-14.





Lightning Age	Symbol
Strike is less than 6 seconds old	
Strike is between 6 and 60 seconds old	
Strike is between 1 and 2 minutes old	
Strike is between 2 and 3 minutes old	

Table 6-14 Lightning Age and Symbols

SETTING UP LIGHTNING DETECTION ON THE NAVIGATION MAP

Setting up lightning detection options on the Navigation Map:

- 1) On the Navigation Map Page, press the **MENU** Key.
- 2) With 'Map Setup' selected (Figure 6-127), press the **ENT** Key.
- 3) Turn the small **FMS** Knob to display the group selection window. Turn the small **FMS** Knob to select 'Weather' (Figure 6-90), and press the **ENT** Key.
- 4) Turn the large **FMS** Knob to highlight and move between the product selections.
- 5) When an item is highlighted, turn the small **FMS** Knob to select the option.
- 6) Press the **ENT** Key.
- 7) Push the **FMS** Knob to return to the Navigation Map Page (Figure 6-129).

The following options are available (Figure 6-128):

- **STRMSCP LTNG** – Turns the display of lightning detection data on or off.
- **STRMSCP MODE** – Selects the CELL or STRIKE mode of lightning activity. Cell mode identifies clusters or cells of electrical activity. Strike mode indicates the approximate location of lightning strikes.
- **STRMSCP SMBL** – Selects the range at which Stormscope data displays. The system removes Stormscope information when a map range greater than the STRMSCP SMBL value is selected.

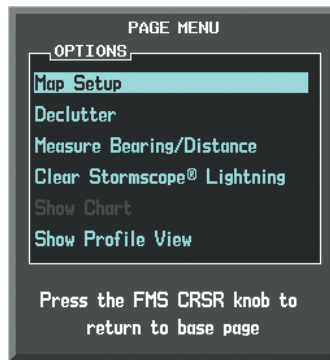

Figure 6-127 Navigation Map Page Menu

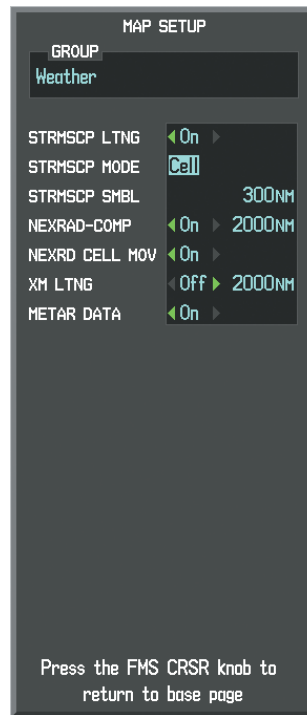

Figure 6-128 Map Setup Menu

CELL AND STRIKE MODE ON THE NAVIGATION MAP

On the Navigation Map, cell mode identifies cells of lightning activity (Figure 6-129). The system identifies clusters of electrical activity that indicate cells. Strike mode indicates the approximate location of lightning strikes.

Selecting the 'cell' or 'strike' mode on the Navigation Map:

- 1) Press the **MENU** Key.
- 2) With 'Map Setup' selected, press the **ENT** Key.
- 3) Select the 'Weather' group.
- 4) Press the **ENT** Key. The cursor flashes on 'STRMSCP LTNG'.
- 5) Turn the **large FMS** Knob to select 'STRMSCP MODE'.
- 6) Turn the **small FMS** Knob to change between 'CELL' and 'STRIKE' options. When an item is selected, press the **ENT** Key.
- 7) Push the **FMS** knob to return to the Navigation Map Page.



Figure 6-129 Navigation Map Page with Stormscope Lightning Data

If heading input is lost, strikes and/or cells must be cleared manually after the execution of each turn. This is to ensure that the strike and/or cell positions are depicted accurately in relation to the nose of the aircraft.

Manually clearing lightning detection data on the Navigation Map:

- 1) Press the **MENU** Key.
- 2) Select 'Clear Stormscope® Lightning' (Figure 6-130).
- 3) Press the **ENT** Key.



Figure 6-130 Navigation Map Page Menu

ZOOM RANGE ON THE NAVIGATION MAP

Lightning detection information can be displayed up to 800 nm zoom range (in North up mode) on the Navigation Map Page. **However, in the track up mode at the 500 nm range, a portion of the lightning data can be behind the aircraft and therefore not visible on the Navigation Map.** Since the range for Stormscope data is 400 nm diameter total (200 nm in front and 200 nm behind), the 500 nm range in North up mode shows all the data.

At a map range of less than 25 nm, the system removes lightning detection information from the map, although lightning may still be present.

Selecting a lightning detection range on the Navigation Map:

- 1) Press the **MENU** Key.
- 2) Select 'MAP SETUP'.
- 3) Select the 'Weather' group.
- 4) Press the **ENT** Key.
- 5) Turn the **large FMS** Knob to select 'STRMSCP SMBL'.
- 6) Turn the **small FMS** Knob to select the maximum display range.
- 7) Press the **ENT** Key.
- 8) Push the **FMS** Knob to return to the Navigation Map Page.

To change the display range on the Navigation Map Page, turn the **Joystick** clockwise to zoom out or counter-clockwise to zoom in.

SELECTING THE STORMSCOPE PAGE

Lightning data can be displayed at the ranges of 25 nm, 50 nm, 100 nm, and 200 nm.

Adjusting the Stormscope Map Range:

- 1) Turn the large **FMS** Knob to select the Map Page Group.
- 2) Turn the small **FMS** Knob to select the Stormscope Page.
- 3) To change the map range, turn the **Joystick** clockwise to zoom out or counter-clockwise to zoom in.

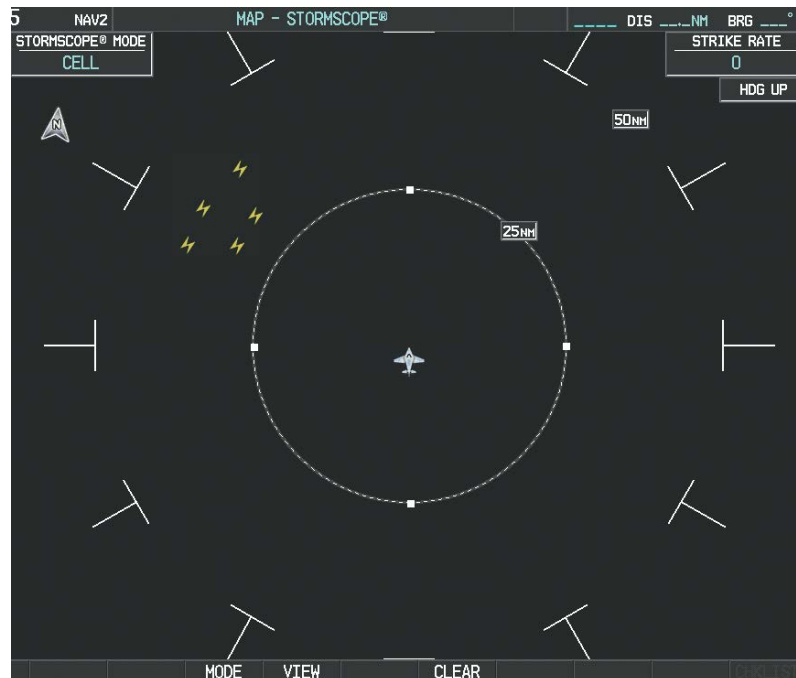

Figure 6-131 Stormscope Page

Changing between 'cell' and 'strike' mode on the Stormscope Page:

- 1) Select the Stormscope Page.
- 2) Press the **MODE** Softkey. The **CELL** and **STRIKE** softkeys are displayed.
- 3) Press the **CELL** Softkey to display 'CELL' data or press the **STRIKE** Softkey to display 'STRIKE' data. 'CELL' or 'STRIKE' is displayed in the mode box in the upper left corner of the Stormscope Page.
- 4) Press the **BACK** Softkey to return to the main Stormscope page.

Changing the viewing mode between 360° and 120° on the Stormscope Page:

- 1) Select the Stormscope Page.
- 2) Press the **VIEW** Softkey. The **360** and **ARC** softkeys are displayed. Press the **360** Softkey to display a 360° viewing area or press the **ARC** Softkey to display a 120° viewing area.
- 3) Press the **BACK** Softkey to return to the main Stormscope Page.

6.5 TERRAIN PROXIMITY



WARNING: Do not use Terrain Proximity information for primary terrain avoidance. Terrain Proximity is intended only to enhance situational awareness.

Perspective® Terrain Proximity is a terrain awareness system that does not comply with TSO-C151b certification standards. It increases situational awareness and aids in reducing controlled flight into terrain (CFIT). Do not confuse Terrain Proximity with Terrain Awareness and Warning System (TAWS). TAWS is more sophisticated and robust, and it is TSO-C151b certified. Terrain Proximity does not provide warning annunciations or voice alerts. It only provides color indications on map displays when terrain and obstacles are within a certain altitude threshold from the aircraft. Although the terrain and obstacle color map displays are the same, TAWS uses more sophisticated algorithms to assess aircraft distance from terrain and obstacles.

Terrain Proximity requires the following components to operate properly:

- Valid 3-D GPS position
- Valid terrain/obstacle database

Terrain Proximity displays altitudes of terrain and obstructions relative to the aircraft position and altitude with reference to a database that may contain inaccuracies. Terrain and obstructions are shown only if they are in the database. Terrain and obstacle information should be used as an aid to situational awareness. They should never be used to navigate or maneuver around terrain.

Note that all obstructions may not be available in the terrain and obstacle database. No terrain and obstacle information is shown without a valid 3-D GPS position.

The GPS receiver provides the horizontal position and altitude. GPS altitude is derived from satellite position. GPS altitude is then converted to the height above geodetic sea level (GSL), which is the height above mean sea level calculated geometrically. GSL altitude is used to determine terrain and obstacle proximity. GSL altitude accuracy is affected by satellite geometry, but is not subject to variations in pressure and temperature that normally affect pressure altitude sensors. GSL altitude does not require local altimeter settings to determine MSL altitude. It is a widely-used MSL altitude source.

Terrain and obstacle databases are referenced to MSL. Using the GPS position and altitude, the Terrain Proximity feature portrays a 2-D picture of the surrounding terrain and obstacles relative to the position and altitude of the aircraft. GPS position and GSL altitude are used to calculate and predict the aircraft's flight path in relation to the surrounding terrain and obstacles. In this way, the pilot can view predicted dangerous terrain and obstacle conditions.

DISPLAYING TERRAIN PROXIMITY DATA

The symbols and colors in Figure 6-132 and Table 6-15 are used to represent obstacles and aircraft altitude when the Terrain Proximity Page is selected for display. Terrain Proximity uses black, yellow, and red to represent terrain information relative to aircraft altitude. The color of each obstacle is associated with the altitude of the aircraft.

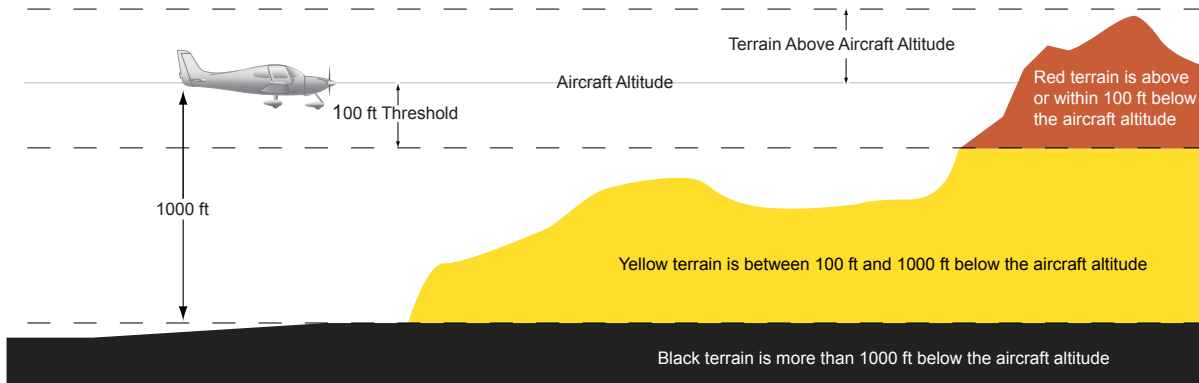

Figure 6-132 Terrain Altitude/Color Correlation for Terrain Proximity

Unlighted Obstacle		Lighted Obstacle		Obstacle Location
< 1000' AGL	> 1000' AGL	< 1000' AGL	> 1000' AGL	
				Red obstacle is above or within 100' below current aircraft altitude
				Yellow obstacle is between 100' and 1000' below current aircraft altitude
				Gray obstacle is more than 1000 ft below aircraft altitude

Table 6-15 Terrain Proximity Terrain/Obstacle Colors and Symbology

Terrain and obstacle information can be displayed on the following pages:

- PFD Inset Map
- Navigation Map Page
- Terrain Proximity Page
- Trip Planning Page
- Flight Plan Page
- AUX - Video Page

Displaying terrain and obstacle information (maps other than the Terrain Proximity Page):

- 1) Press the **MAP** Softkey (for the PFD Inset Map, press the **INSET** Softkey).
- 2) Press the **TERRAIN** Softkey to display terrain and obstacle data.

When Terrain Proximity is selected on maps other than the Terrain Proximity Page, an icon to indicate the feature is enabled for display and a legend for Terrain Proximity colors are shown (Figure 6-136).

The Navigation Map Page Setup Menu provides a means in addition to the softkey for enabling/disabling display of terrain and obstacles. The setup menu also controls the map range settings above which terrain and obstacle data are decluttered from the display. If a map range larger than the map range setting is selected, the data is removed from the map.

Terrain data can be selected for display independently of obstacle data; however, obstacles recognized by Terrain Proximity as yellow or red are shown when terrain is selected for display and the map range is within the setting limit.

Maps besides the Terrain Proximity Page use settings based on those selected for the Navigation Map Page. The maximum display ranges for obstacles on each map are dependent on the range setting made for the Navigation Map. If the maximum range for obstacle display on the Navigation Map is adjusted to below 20 nm, the highest obstacle display range settings on the other applicable maps are also adjusted proportionally.

Customizing terrain and obstacle display on the Navigation Map Page:

- 1) Select the Navigation Map Page.
- 2) Press the **MENU** Key.
- 3) With 'Map Setup' highlighted, press the **ENT** Key (Figure 6-133).
- 4) Turn the small **FMS** Knob to select the 'Map' Group and press the **ENT** Key (Figure 6-134).
- 5) Turn the large **FMS** Knob or press the **ENT** Key to scroll through product selections (Figure 6-135).
 - TERRAIN DATA – Turns the display of terrain data on or off and sets maximum range at which terrain is shown
 - OBSTACLE DATA – Turns the display of obstacle data on or off and sets maximum range at which obstacles are shown
- 6) Turn the small **FMS** Knob to scroll through options for each product (ON/OFF, range settings).
- 7) Press the **ENT** Key to select an option.
- 8) Push the **FMS** Knob or **CLR** Key to return to the Navigation Map Page with the changed settings.

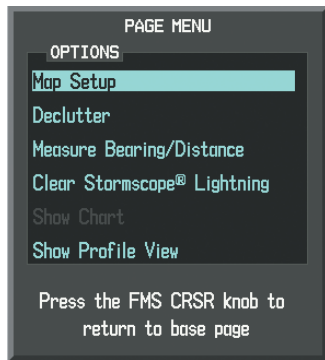

Figure 6-133 Navigation Map Page Menu

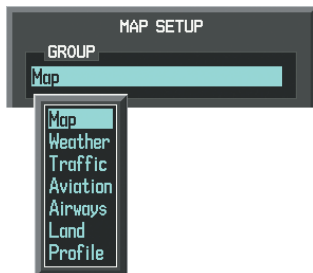

Figure 6-134 Navigation Map Page Setup Menu



Figure 6-135 Navigation Map Page Setup Menu, Map Group

Additional information about obstacles can be displayed by panning over the display on the map. The map panning feature is enabled by pressing the **Joystick**. The map range is adjusted by turning the **Joystick**. If the map range is adjusted while panning is enabled, the map is re-centered on the Map Pointer.

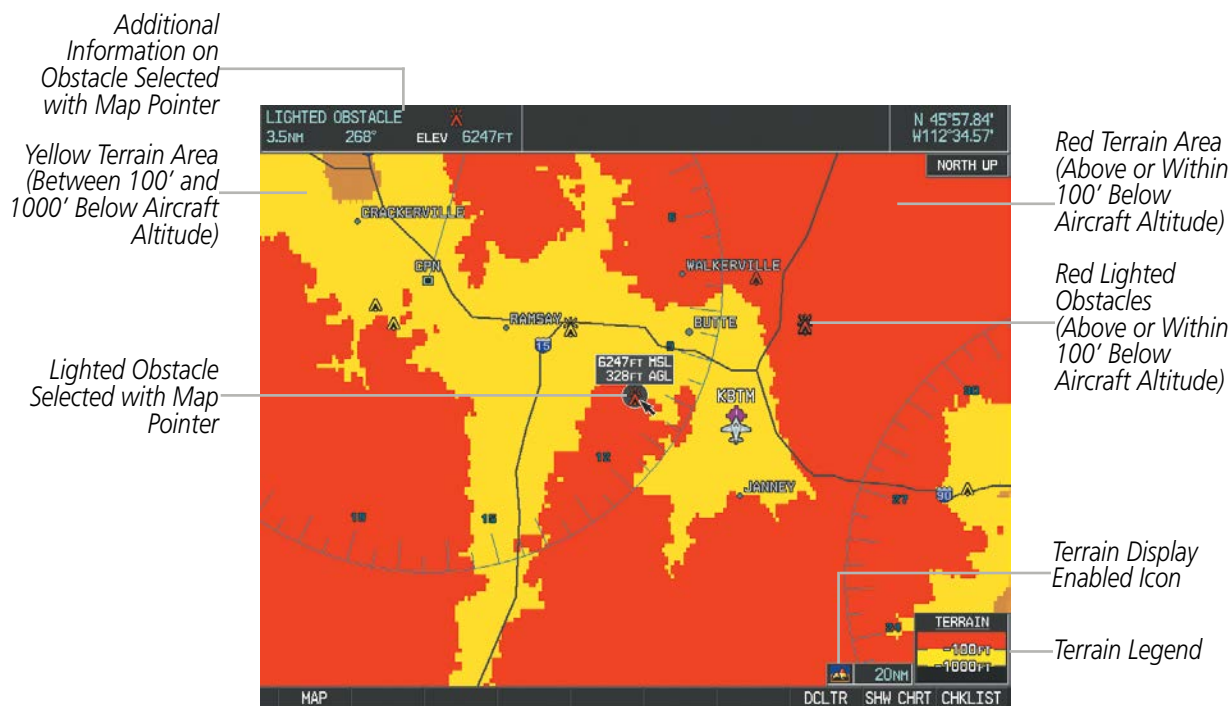

Figure 6-136 Terrain Information on the Navigation Map Page

TERRAIN PROXIMITY PAGE

The Map - Terrain Proximity Page is the principal map page for showing terrain and obstacle data in relation to the aircraft's current altitude, without clutter from the basemap. Aviation information (airports, VORs, and other NAVAIDs) can be displayed for reference.

Aircraft orientation on this map is always heading up unless there is no valid heading. Two views are available relative to the position of the aircraft: the 360° default display and the radar-like ARC (120°) display. Map range is adjustable with the **Joystick** from 1 to 200 nm, as indicated by the map range rings (or arcs).

Displaying the Terrain Proximity Page:

- 1) Turn the large **FMS** Knob to select the Map Page Group.
- 2) Turn the small **FMS** Knob to select the Terrain Proximity Page.
- 3) To change the view,
 - a) Press the **VIEW** Softkey.
 - b) Press the **360** or **ARC** Softkey to select the desired view.

Or:

 - a) Press the **MENU** Key.
 - b) Select 'View Arc' or 'View 360°' (choice dependent on current state) and press the **ENT** Key to change the view.

Showing/hiding aviation information on the Terrain Proximity Page:

- 1) Press the **MENU** Key.
- 2) Select 'Show Aviation Data' or 'Hide Aviation Data' (choice dependent on current state) and press the **ENT** Key.

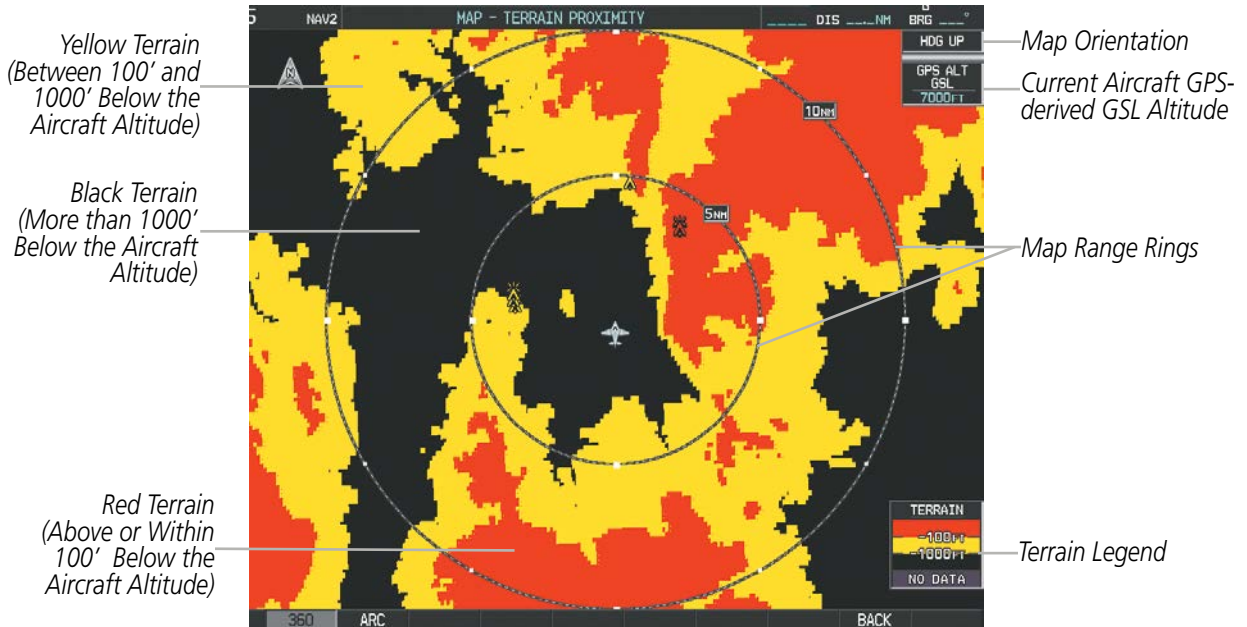

Figure 6-137 Terrain Proximity Page (360 View)

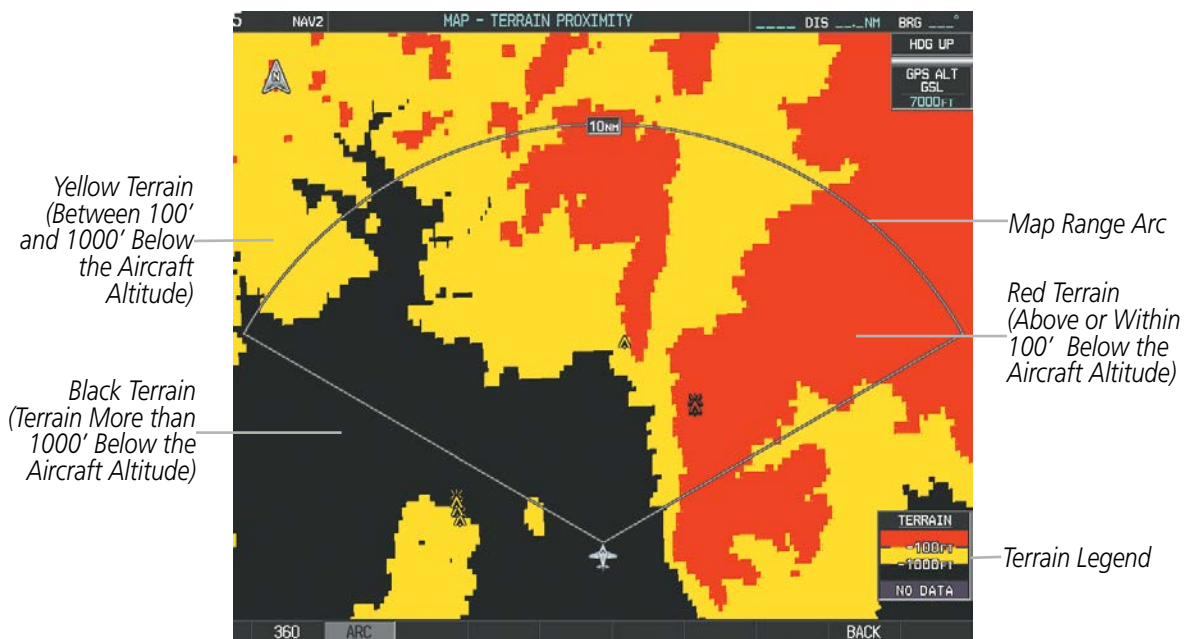

Figure 6-138 Terrain Proximity Page (ARC View)

6.6 TERRAIN-SVS



WARNING: Do not use Terrain-SVS information for primary terrain avoidance. Terrain-SVS is intended only to enhance situational awareness.



NOTE: Terrain-SVS is included with the Synthetic Vision Technology (SVT) system option. If the TAWS-B option is also installed, it will take precedence over Terrain-SVS.



NOTE: Terrain-SVS information is not displayed if the aircraft is outside of the installed terrain database coverage area.

Terrain-SVS is a terrain awareness system integrated with the optional Synthetic Vision Technology (SVT) system. Terrain-SVS provides visual and auditory alerting to indicate the presence of threatening terrain or obstacles relevant to the projected flight path. For detailed information regarding SVT, refer to the Additional Features section.

Terrain-SVS does not comply with TSO-C151b certification standards. It increases situational awareness and aids in reducing controlled flight into terrain (CFIT). Do not confuse Terrain-SVS with the optional Terrain Awareness and Warning System (TAWS). TAWS is more sophisticated and robust, and it is TSO-C151b certified. Although the terrain and obstacle color map displays are the same, TAWS uses more sophisticated algorithms to assess aircraft distance from terrain and obstacles and provides additional alerting capabilities.

Terrain-SVS does not provide the following:

- Premature Descent Alerting (PDA)
- Excessive Descent Rate (EDR)
- Negative Climb Rate (NCR)
- Descent to 500 Feet Callout (DFC)

Terrain-SVS requires the following components to operate properly:

- Valid 3-D GPS position
- Valid terrain/obstacle database

Terrain-SVS displays altitudes of terrain and obstructions relative to the aircraft position and altitude with reference to a database that may contain inaccuracies. Terrain and obstructions are shown only if they are in the database. Terrain and obstacle information should be used as an aid to situational awareness. They should never be used to navigate or maneuver around terrain.

Note that all obstructions may not be available in the terrain and obstacle database. No terrain and obstacle information is shown without a valid 3-D GPS position.

The GPS receiver provides the horizontal position and altitude. GPS altitude is derived from satellite position. GPS altitude is then converted to the height above geodetic sea level (GSL), which is the height above mean sea level calculated geometrically. GSL altitude is used to determine terrain and obstacle proximity. GSL altitude accuracy is affected by satellite geometry, but is not subject to variations in pressure and temperature that normally affect pressure altitude sensors. GSL altitude does not require local altimeter settings to determine MSL altitude. It is a widely-used MSL altitude source.

Terrain and obstacle databases are referenced to GSL. Using the GPS position and altitude, the Terrain-SVS feature portrays a 3-D picture of the surrounding terrain and obstacles relative to the position and altitude of the aircraft. GPS position and GSL altitude are used to calculate and predict the aircraft's flight path in relation to the surrounding terrain and obstacles. In this way, the pilot can view predicted dangerous terrain and obstacle conditions.

DISPLAYING TERRAIN-SVS DATA

Terrain-SVS uses yellow (caution) and red (warning) to depict terrain and obstacles (with heights greater than 200 feet above ground level, AGL) alerts relative to aircraft altitude. Colors are adjusted automatically as the aircraft altitude changes. The colors and symbols in Figure 6-139 and Table 6-16 and Table 6-17 are used to represent terrain, obstacles, and potential impact points.

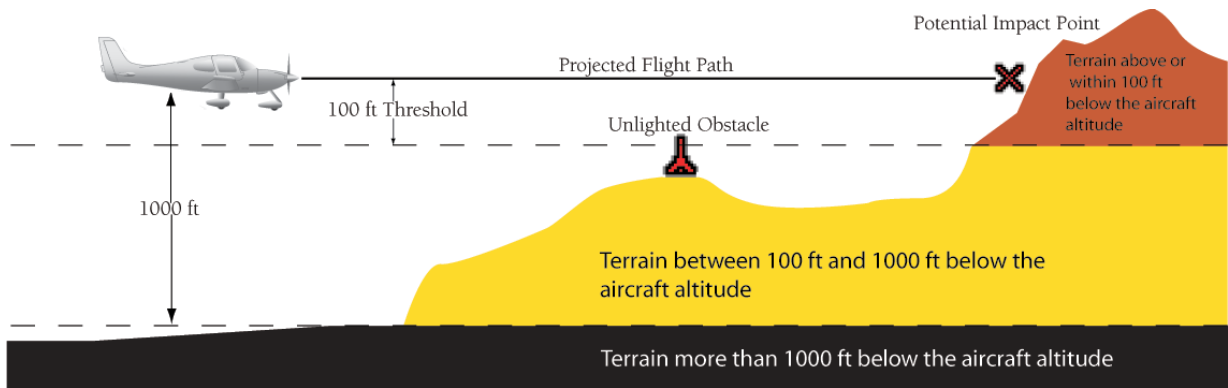

Figure 6-139 Terrain Altitude/Color Correlation for TERRAIN-SVS

Unlighted Obstacle		Lighted Obstacle		Obstacle Location
< 1000' AGL	> 1000' AGL	< 1000' AGL	> 1000' AGL	
				Red obstacle is above or within 100' below current aircraft altitude
				Yellow obstacle is between 100' and 1000' below current aircraft altitude
				Gray obstacle is more than 1000 ft below aircraft altitude

Table 6-16 Terrain-SVS Obstacle Colors and Symbology

Potential Impact Point Symbol	Alert Type	Example Annunciation
	Warning	
	Caution	

Table 6-17 Terrain-SVS Potential Impact Point Symbols with Alert Types

Terrain-SVS information can be displayed on the following maps:

- PFD Inset Map
- Navigation Map Page
- Terrain-SVS Page
- Trip Planning Page
- Flight Plan Pages
- AUX - Video Page

Displaying terrain and obstacle information (maps other than the Terrain-SVS Page):

- 1) Select the **MAP** Softkey (for the PFD Inset Map, press the **INSET** Softkey).
- 2) Select the **TERRAIN** Softkey to display terrain and obstacle data.

When Terrain-SVS is selected on maps other than the Terrain-SVS Page, an icon to indicate the feature is enabled for display and a legend for Terrain-SVS terrain colors are shown (Figure 6-146).

The Navigation Map Page Setup Menu provides a means in addition to the softkeys for enabling/disabling the display of terrain and obstacles. The setup menu also controls the map range settings above which terrain and obstacle data are decluttered from the display. If a map range larger than the map range setting is selected, the data is removed from the map. For terrain data, the enable/disable function applies only to the MFD, while the range setting also affects the PFD Inset Map.

Terrain data can be selected for display independently of obstacle data; however, obstacles for which warnings and cautions are issued are shown when terrain is selected for display and the map range is within the setting limit.

Maps besides the Terrain-SVS Page use settings based on those selected for the Navigation Map Page. The maximum display ranges for obstacles on each map are dependent on the range setting made for the Navigation Map. If the maximum range for obstacle display on the Navigation Map is adjusted to below 20 nm, the highest obstacle display range settings on the other applicable maps are also adjusted proportionally.

Customizing terrain and obstacle display on the Navigation Map Page:

- 1) Select the Navigation Map Page.
- 2) Press the **MENU** Key.
- 3) With 'Map Setup' highlighted, press the **ENT** Key (Figure 6-140).
- 4) Turn the small **FMS** Knob to select the 'Map' Group and press the **ENT** Key (Figure 6-141).
- 5) Turn the large **FMS** Knob or press the **ENT** Key to scroll through product selections (Figure 6-142).
 - TERRAIN DATA – Turns the display of terrain data on or off and sets maximum range at which terrain is shown
 - OBSTACLE DATA – Turns the display of obstacle data on or off and sets maximum range at which obstacles are shown
- 6) Turn the small **FMS** Knob to scroll through options for each product (ON/OFF, range settings).
- 7) Press the **ENT** Key to select an option.
- 8) Push the **FMS** Knob or **CLR** Key to return to the Navigation Map Page with the changed settings.

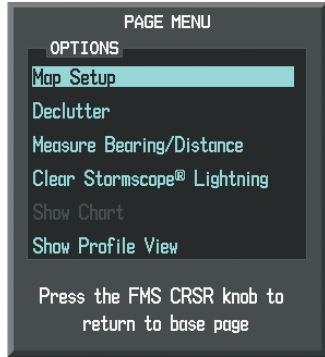

Figure 6-140 Navigation Map Page Menu



Figure 6-141 Navigation Map Page Setup Menu

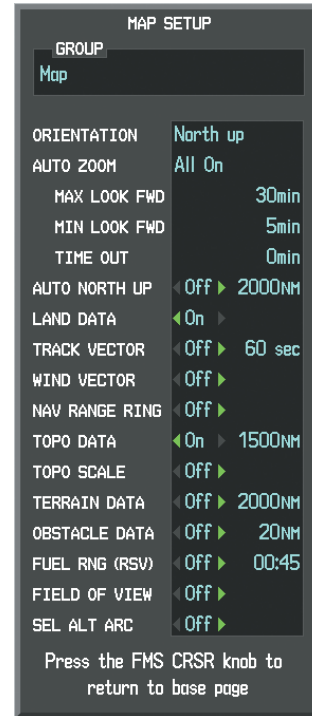

Figure 6-142 Navigation Map Page Setup Menu, Map Group

TERRAIN-SVS PAGE

The Map - Terrain-SVS Page is the principal map page for viewing terrain, obstacle, and potential impact point data in relation to the aircraft's current altitude, without clutter from the basemap. Aviation information (airports, VORs, and other NAVAIDs) can be displayed for reference. If an obstacle and the projected flight path of the aircraft intersect, the display automatically zooms in to the closest potential point of impact on the Terrain-SVS Page.

Aircraft orientation on this map is always heading up unless there is no valid heading. Two views are available relative to the position of the aircraft: the 360° default display and the radar-like ARC (120°) display. Map range is adjustable with the **Joystick** from 1 to 200 nm, as indicated by the map range rings (or arcs).

Displaying the Terrain-SVS Page:

- 1) Turn the large **FMS** Knob to select the Map Page Group.
- 2) Turn the small **FMS** Knob to select the Terrain-SVS Page.

Changing the Terrain-SVS Page view:

- 1) Press the **VIEW** Softkey.
- 2) Press the **360** or **ARC** Softkey to select the desired view.

Or:

- 1) Press the **MENU** Key.
- 2) Select 'View Arc' or 'View 360°' (choice dependent on current state) and press the **ENT** Key to change the view

Showing/hiding aviation information on the Terrain-SVS Page:

- 1) Press the **MENU** Key.
- 2) Select 'Show Aviation Data' or 'Hide Aviation Data' (choice dependent on current state) and press the **ENT** Key.

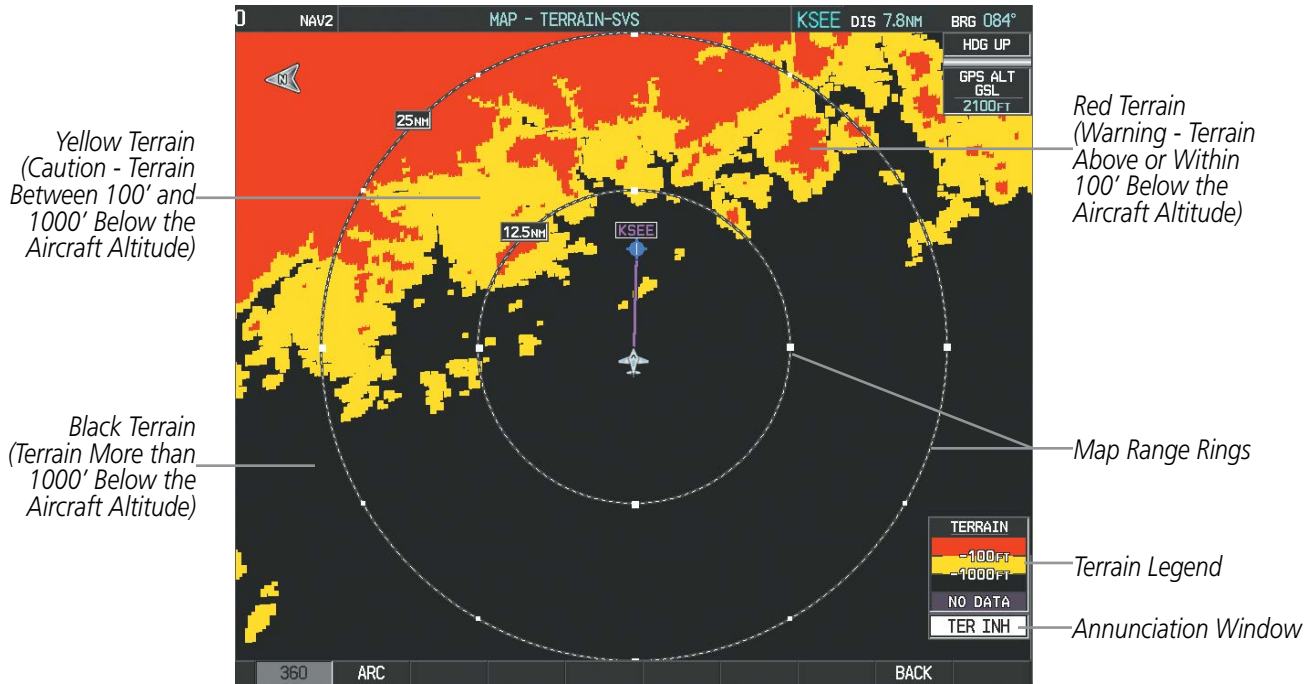

Figure 6-143 Terrain-SVS Page

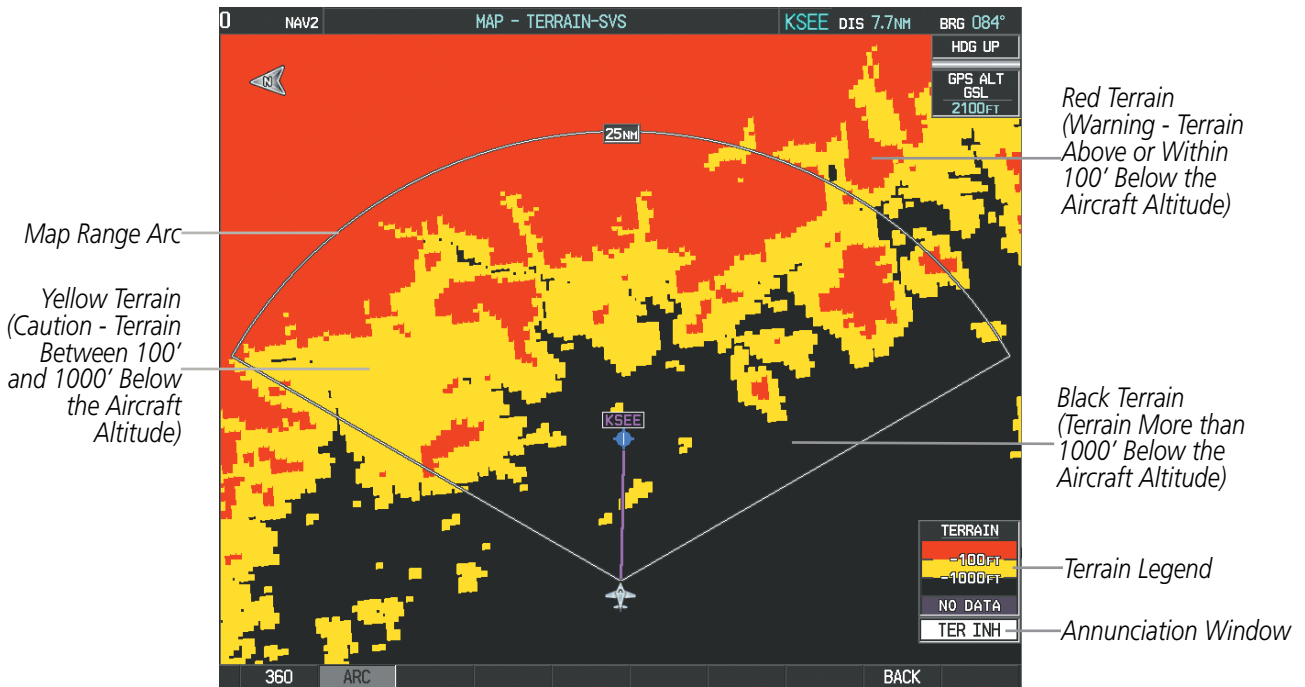

Figure 6-144 Terrain-SVS Page (ARC View)

TERRAIN-SVS ALERTS

Alerts are issued when flight conditions meet parameters that are set within Terrain-SVS software algorithms. Terrain-SVS alerts typically employ a CAUTION or a WARNING alert severity level, or both. When an alert is issued, the system provides visual annunciations and voice alerts. Table 6-18 shows Terrain-SVS alert types with corresponding annunciations and voice messages.

When an alert is issued, annunciations appear on the PFD and MFD. The Terrain-SVS Alert Annunciation is shown to the upper left of the Altimeter on the PFD and below the Terrain Legend on the MFD. If the Terrain-SVS Page is not displayed at the time, a pop-up alert appears on the MFD. To acknowledge the pop-up alert:

- Press the **CLR** Key (returns to the currently viewed page), or
- Press the **ENT** Key (accesses the Terrain-SVS Page)

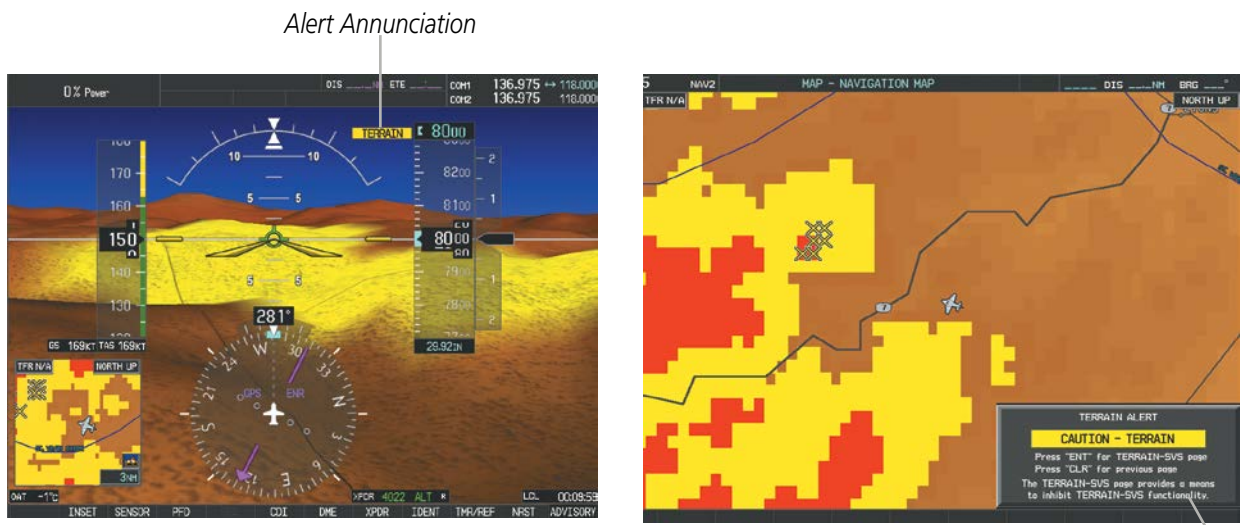

Figure 6-145 Terrain-SVS Alert Annunciations

Pop-up Alert

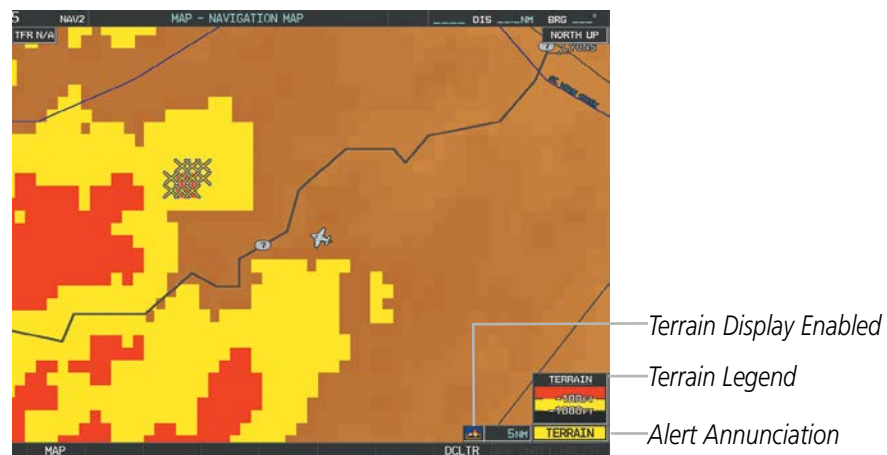

Figure 6-146 Navigation Map Page (After Terrain-SVS Pop-up Alert Acknowledgment)

Terrain Display Enabled
 Terrain Legend
 Alert Annunciation

Alert Type	PFD/MFD* Alert Annunciation	MFD Pop-Up Alert (except Terrain-SVS Page)	Voice Alert
Reduced Required Terrain Clearance Warning (RTC)	TERRAIN	WARNING - TERRAIN	"Warning; Terrain, Terrain"
Imminent Terrain Impact Warning (ITI)	TERRAIN	WARNING - TERRAIN	"Warning; Terrain, Terrain"
Reduced Required Obstacle Clearance Warning (ROC)	TERRAIN	WARNING - OBSTACLE	"Warning; Obstacle, Obstacle"
Imminent Obstacle Impact Warning (IOI)	TERRAIN	WARNING - OBSTACLE	"Warning; Obstacle, Obstacle"
Reduced Required Terrain Clearance Caution (RTC)	TERRAIN	CAUTION - TERRAIN	"Caution; Terrain, Terrain"
Imminent Terrain Impact Caution (ITI)	TERRAIN	CAUTION - TERRAIN	"Caution; Terrain, Terrain"
Reduced Required Obstacle Clearance Caution (ROC)	TERRAIN	CAUTION - OBSTACLE	"Caution; Obstacle, Obstacle"
Imminent Obstacle Impact Caution (IOI)	TERRAIN	CAUTION - OBSTACLE	"Caution; Obstacle, Obstacle"

* Annunciation is displayed on the MFD when terrain display is enabled.

Table 6-18 Terrain-SVS Alerts Summary

FORWARD LOOKING TERRAIN AVOIDANCE

The Forward Looking Terrain Avoidance (FLTA) feature of Terrain-SVS compares the projected flight path as derived from GPS data with terrain features and obstacles from the terrain and obstacle databases. The system issues visual annunciations and voice alerts when the projected flight path conflicts with terrain or obstacles.

The projected flight path is a calculated area ahead of, to the sides, and below the aircraft. The size of the projected flight path varies based on factors including ground speed (the path ahead is larger when the ground speed is higher), whether the aircraft is level, turning, or descending, and the proximity to the nearest runway along the current track. As the aircraft approaches the runway, the projected flight path becomes narrower until the system automatically disables FLTA alerts or the pilot manually inhibits them.

There are two types of FLTA alerts, Reduced Required Terrain/Obstacle Clearance (RTC or ROC respectively) and Imminent Terrain/Obstacle Impact (ITI or IOI respectively).

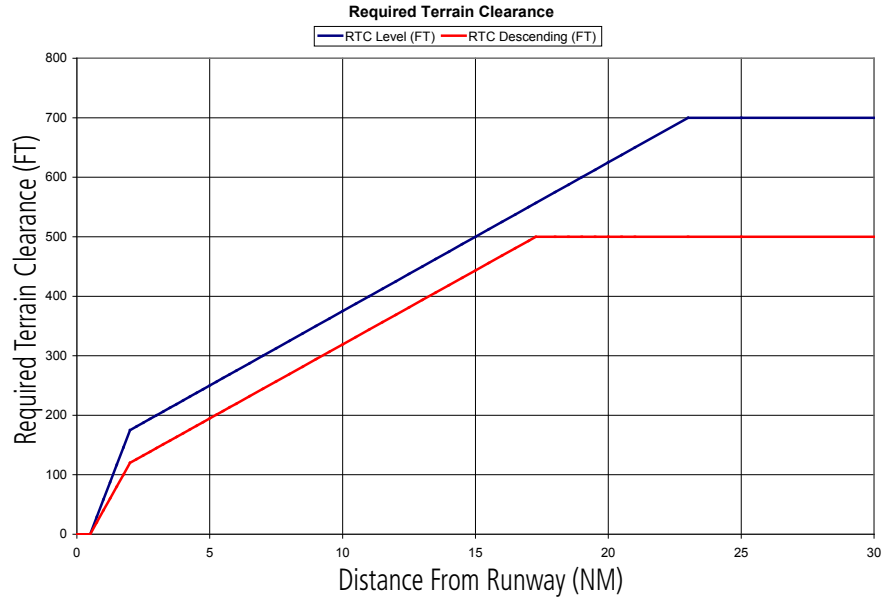

Figure 6-147 FLTA Alert Minimum Terrain and Obstacle Clearance Values

The system automatically disables FLTA alerts when the aircraft is less than 200 feet above the destination runway elevation while within 0.5 nm of the approach runway or the aircraft is between runway ends.

The pilot manually inhibit FLTA alerts. Discretion should be used when inhibiting FLTA alerts. When Terrain-SVS alerts are inhibited, the system displays the ‘TER INH’ annunciation on the PFD and in the MFD terrain annunciation window.

TER INH

Figure 6-148 Terrain-SVS Alerting Disabled (Terrain-SVS Inhibited) Annunciation

Inhibiting/enabling Terrain-SVS alerting:

- 1) Select the Terrain-SVS Page.
- 2) Select the **INHIBIT** Softkey to inhibit or enable Terrain-SVS (choice dependent on current state).

Or:

- a) Press the **MENU** Key.
- b) Select ‘Inhibit Terrain’ or ‘Enable Terrain’ (choice dependent on current state) and press the **ENT** Key.

While Terrain-SVS alerting is manually inhibited (or the Terrain-SVS system is not available or has failed), the system may display a ‘LOW ALT’ annunciation if the following conditions are met:

- The aircraft is on a GPS SBAS approach.
- The Final Approach Fix is the active waypoint.
- The aircraft is at least 164 feet below the prescribed altitude at the Final Approach Fix.

See the Flight Instruments Section for more details about the ‘LOW ALT’ annunciation.

SYSTEM STATUS

During power-up, the Terrain-SVS system conducts a test of its alerting capabilities. The system issues single chime or a voice alert when the test has completed, depending on the test outcome.

System Status	PFD/MFD Alert Annunciation	Audio/Voice Alert
System Test in Progress	TER TEST	None
System Test Pass	None	Single Chime
Terrain System Test Fail	TER FAIL	"Terrain System Failure"

Table 6-19 Terrain-SVS System Test Status Annunciations

Terrain-SVS continually monitors several system-critical items such as database validity, hardware status, and GPS status. If the terrain/obstacle database is not available, the voice alert **"Terrain System Failure"** is generated along with the 'TER FAIL' alert annunciation.

Terrain-SVS requires a 3-D GPS navigation solution along with specific vertical accuracy minimums. Should the navigation solution become degraded or if the aircraft is out of the database coverage area, the annunciation 'TER N/A' is generated in the annunciation window and on the Terrain-SVS Page. The voice alert **"Terrain System Not Available"** is generated. When the GPS signal integrity returns and the aircraft is within the database coverage area, the voice alert **"Terrain System Available"** is generated.

Alert Cause	PFD/MFD Alert Annunciation	Terrain-SVS Page Annunciation	Voice Alert
MFD Terrain or Obstacle database unavailable or invalid. Terrain-SVS operating with PFD Terrain or Obstacle databases	None	TERRAIN DATABASE FAILURE	None
Terrain or Obstacle database unavailable or invalid, invalid software configuration, audio fault	TER FAIL	TERRAIN FAIL	"Terrain System Failure"
No GPS position	TER N/A	NO GPS POSITION	"Terrain System Not Available" "Terrain System Available" when GPS position is available
Excessively degraded GPS signal	TER N/A	None	"Terrain System Not Available" "Terrain System Available" when sufficient GPS signal is received
Out of database coverage area	TER N/A	None	"Terrain System Not Available" "Terrain System Available" when aircraft re-enters database coverage area.

Table 6-20 Terrain-SVS Abnormal Annunciations

6.7 TAWS-B



WARNING: Do not use TAWS information for primary terrain avoidance. TAWS is intended only to enhance situational awareness.



NOTE: The data contained in the TAWS databases comes from government agencies. Garmin accurately processes and cross-validates the data but cannot guarantee the accuracy and completeness of the data.



NOTE: Terrain data is not displayed if the aircraft is outside of the installed terrain database coverage area.

TAWS-B (Terrain Awareness and Warning System - Class B) is an optional feature to increase situational awareness and aid in reducing controlled flight into terrain (CFIT). TAWS-B provides visual annunciations and voice alerts when terrain and obstacles are within the given altitude threshold from the aircraft. The displayed alerts and warnings are advisory in nature only.

TAWS-B satisfies TSO-C151b Class B requirements for certification. TAWS-B requires the following to operate properly:

- A valid terrain/obstacle/airport terrain database
- A valid 3-D GPS position solution

TAWS-B uses terrain and obstacle information supplied by government sources. Terrain information is based on terrain elevation information in a database that may contain inaccuracies. Individual obstructions may be shown if available in the database. The data undergoes verification by Garmin to confirm accuracy of the content, per TSO-C151b. However, the displayed information should never be understood as being all-inclusive and data may be inaccurate.

TAWS-B uses information provided from the GPS receiver to provide a horizontal position and altitude. GPS altitude is derived from satellite measurements. GPS altitude is then converted to the height above geodetic sea level (GSL), which is the height above mean sea level (MSL) calculated geometrically. GSL altitude is used to determine TAWS-B alerts. GSL altitude accuracy is affected by satellite geometry, but is not subject to variations in pressure and temperature that normally affect pressure altitude sensors. GSL altitude does not require local altimeter settings to determine MSL altitude. It is a widely-used MSL altitude source. Therefore, GSL altitude provides a highly accurate and reliable MSL altitude source to calculate terrain and obstacle alerts.

The terrain and obstacle databases used by TAWS-B are referenced to MSL. Using the GPS position and GSL altitude, TAWS-B displays a 2-D picture of the surrounding terrain and obstacles relative to the position and altitude of the aircraft. Furthermore, the GPS position and GSL altitude are used to calculate and “predict” the aircraft’s flight path in relation to the surrounding terrain and obstacles. In this manner, TAWS-B can provide advanced alerts of predicted dangerous terrain conditions.

Baro-corrected altitude (or indicated altitude) is derived by adjusting the altimeter setting for local atmospheric conditions. The most accurate baro-corrected altitude can be achieved by frequently updating the altimeter setting to the nearest reporting station along the flight path. However, because actual atmospheric conditions seldom match the standard conditions defined by the International Standard Atmosphere (ISA) model (where pressure, temperature, and lapse rates have fixed values), it is common for the baro-corrected altitude (as read from the altimeter) to differ from the GSL altitude. This variation results in the aircraft’s GSL altitude differing from the baro-corrected altitude.

DISPLAYING TAWS-B DATA

TAWS-B uses yellow (caution) and red (warning) to depict terrain and obstacles (with heights greater than 200 feet above ground level, AGL) alerts relative to aircraft altitude. Colors are adjusted automatically as the aircraft altitude changes. The colors and symbols in Figure 6-149 and Tables 6-21 and 6-22 are used to represent terrain, obstacles, and potential impact points.

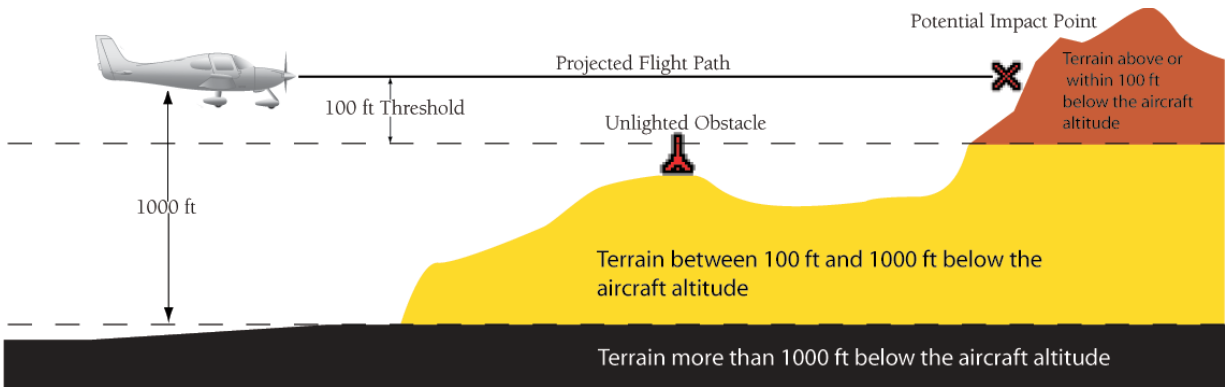

Figure 6-149 Terrain Altitude/Color Correlation for TAWS-B

Unlighted Obstacle		Lighted Obstacle		Obstacle Location
< 1000' AGL	> 1000' AGL	< 1000' AGL	> 1000' AGL	
				Red obstacle is above or within 100' below current aircraft altitude
				Yellow obstacle is between 100' and 1000' below current aircraft altitude
				Gray obstacle is more than 1000 ft below aircraft altitude

Table 6-21 TAWS-B Obstacle Colors and Symbology

Potential Impact Point Symbol	Alert Type	Example Annunciation
	Warning	
	Caution	

Table 6-22 TAWS-B Potential Impact Point Symbols with Alert Types

TAWS-B information can be displayed on the following maps:

- PFD Inset Map
- Navigation Map Page
- TAWS-B Page
- Trip Planning Page
- Flight Plan Page
- AUX - Video Page

Displaying terrain and obstacle information (maps other than the TAWS-B Page):

- 1) Select the **MAP** Softkey (for the PFD Inset Map, press the **INSET** Softkey).
- 2) Select the **TERRAIN** Softkey to display terrain and obstacle data.

When TAWS-B is selected on maps other than the TAWS-B Page, an icon to indicate the feature is enabled for display and a legend for TAWS-B terrain colors are shown (Figure 6-156).

The Navigation Map Page Setup Menu provides a means in addition to the softkey for enabling/disabling display of terrain and obstacles. The setup menu also controls the map range settings above which terrain and obstacle data are decluttered from the display. If a map range larger than the map range setting is selected, the data is removed from the map. For terrain data, the enable/disable function applies only to the MFD, while the range setting also affects the PFD Inset Map.

Terrain data can be selected for display independently of obstacle data; however, obstacles for which warnings and cautions are issued are shown when terrain is selected for display and the map range is within the setting limit.

Maps besides the TAWS-B Page use settings based on those selected for the Navigation Map Page. The maximum display ranges for obstacles on each map are dependent on the range setting made for the Navigation Map. If the maximum range for obstacle display on the Navigation Map is adjusted to below 20 nm, the highest obstacle display range settings on the other applicable maps are also adjusted proportionally.

Customizing terrain and obstacle display on the Navigation Map Page:

- 1) Select the Navigation Map Page.
- 2) Press the **MENU** Key.
- 3) With 'Map Setup' highlighted, press the **ENT** Key (Figure 6-150).
- 4) Turn the small **FMS** Knob to select the 'Map' Group and press the **ENT** Key (Figure 6-151).
- 5) Turn the large **FMS** Knob or press the **ENT** Key to scroll through product selections (Figure 6-152).
 - **TERRAIN DATA** – Turns the display of terrain data on or off and sets maximum range at which terrain is shown
 - **OBSTACLE DATA** – Turns the display of obstacle data on or off and sets maximum range at which obstacles are shown
- 6) Turn the small **FMS** Knob to scroll through options for each product (ON/OFF, range settings).
- 7) Press the **ENT** Key to select an option.
- 8) Push the **FMS** Knob or **CLR** Key to return to the Navigation Map Page with the changed settings.



Figure 6-150 Navigation Map Page Menu

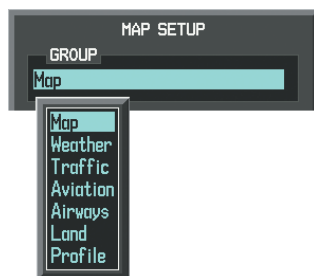

Figure 6-151 Navigation Map Page Setup Menu

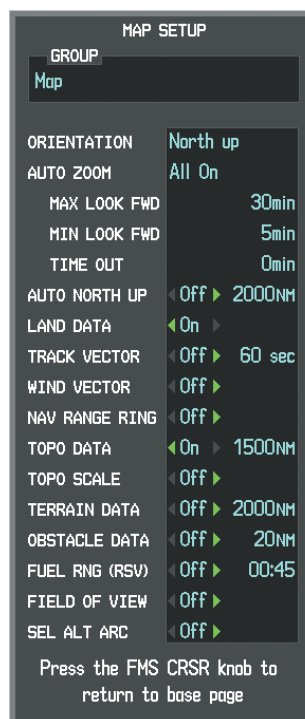

Figure 6-152 Navigation Map Page Setup Menu, Map Group

TAWS-B PAGE

The Map - TAWS-B Page is the principal map page for viewing terrain, obstacle, and potential impact point data in relation to the aircraft's current altitude, without clutter from the basemap. Aviation information (airports, VORs, and other NAVAIDs) can be displayed for reference. If an obstacle and the projected flight path of the aircraft intersect, the display automatically zooms in to the closest potential point of impact on the TAWS-B Page.

Aircraft orientation on this map is always heading up unless there is no valid heading. Two views are available relative to the position of the aircraft: the 360° default display and the radar-like ARC (120°) display. Map range is adjustable with the **Joystick** from 1 to 200 nm, as indicated by the map range rings (or arcs).

Displaying the TAWS-B Page:

- 1) Turn the large **FMS** Knob to select the Map Page Group.
- 2) Turn the small **FMS** Knob to select the TAWS-B Page.

Changing the TAWS-B Page view:

- 1) Press the **VIEW** Softkey.
- 2) Select the **360** or **ARC** Softkey to select the desired view.

Or:

- 1) Press the **MENU** Key.
- 2) Select 'View Arc' or 'View 360°' (choice dependent on current state) and press the **ENT** Key to change the view.

Showing/hiding aviation information on the TAWS-B Page:

- 1) Press the **MENU** Key.
- 2) Select 'Show Aviation Data' or 'Hide Aviation Data' (choice dependent on current state) and press the **ENT** Key.

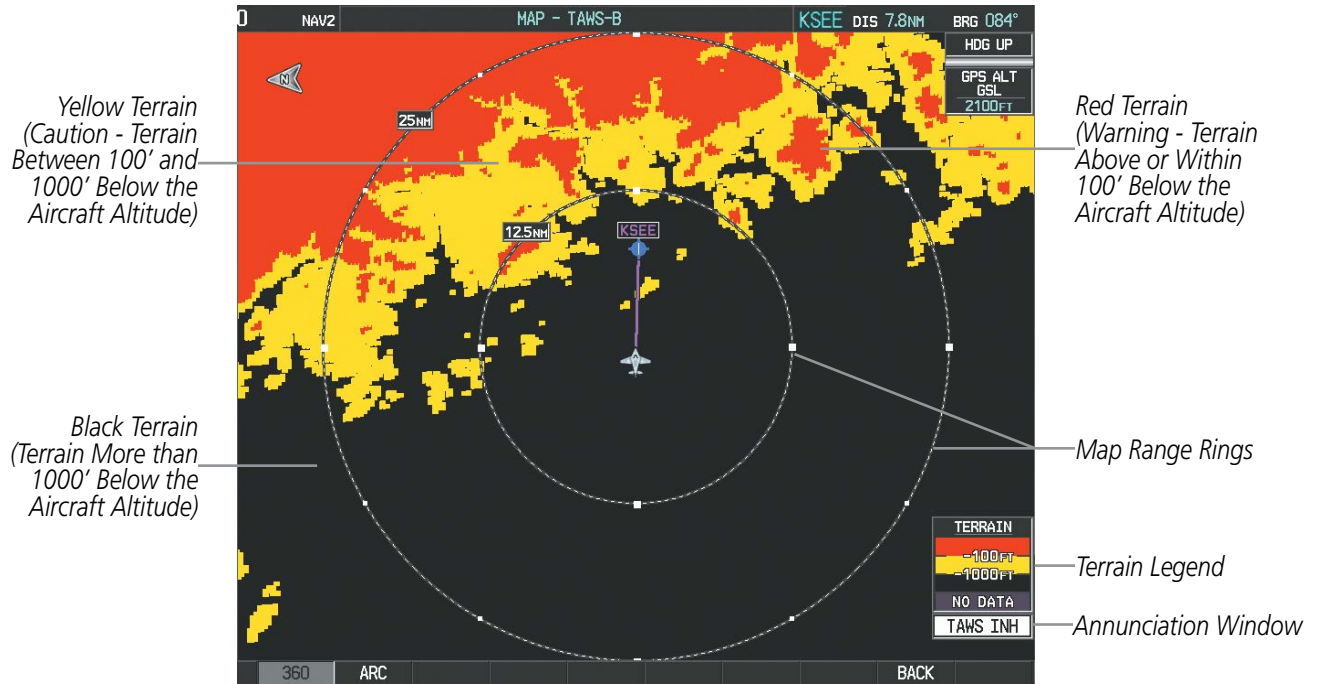

Figure 6-153 TAWS-B Page (360 View)

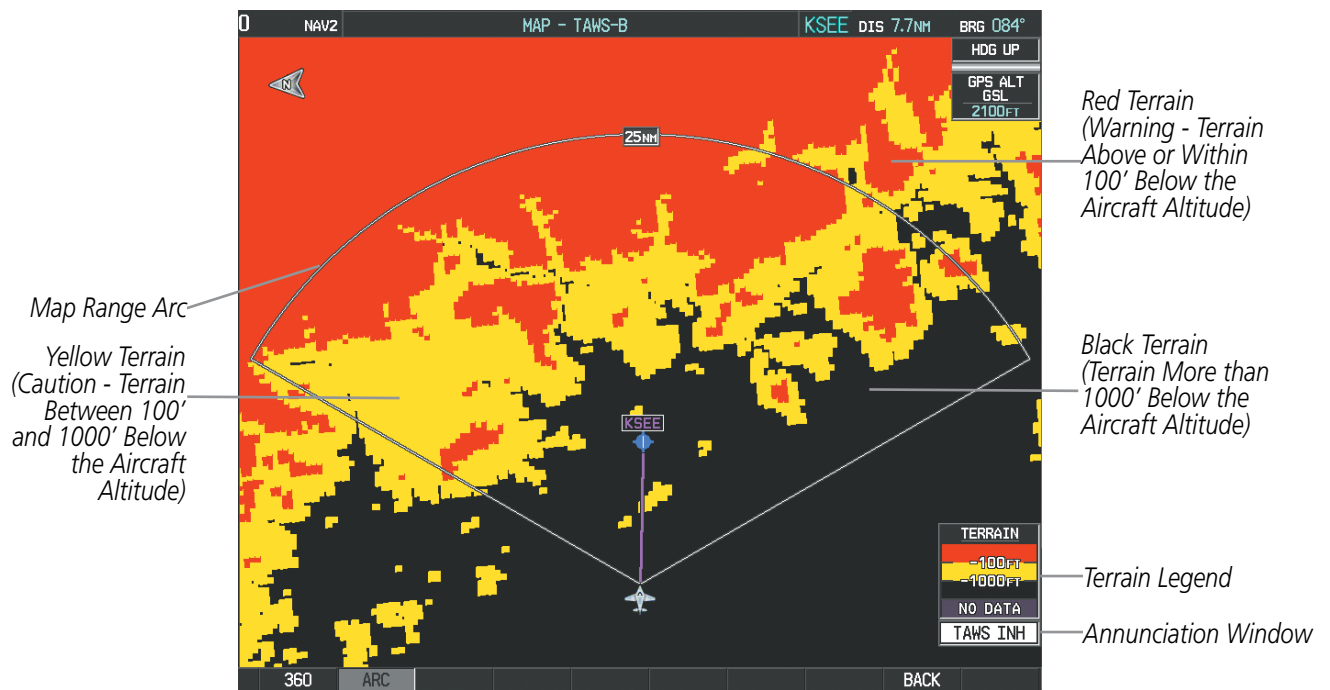

Figure 6-154 TAWS-B Page (ARC View)

SYSTEM OVERVIEW

FLIGHT INSTRUMENTS

EIS

AUDIO PANEL & CNS

FLIGHT MANAGEMENT

HAZARD AVOIDANCE

AFCS

ADDITIONAL FEATURES

APPENDICES

INDEX

TAWS-B ALERTS

Alerts are issued when flight conditions meet parameters that are set within TAWS-B software algorithms. TAWS-B alerts typically employ a CAUTION or a WARNING alert severity level, or both. When an alert is issued, the system displays visual annunciations with voice alerts. Table 6-23 shows TAWS-B alert types with corresponding annunciations and voice alerts.

When an alert is issued, annunciations appear on the PFD and MFD. The TAWS-B Alert Annunciation is shown to the upper left of the Altimeter on the PFD and below the Terrain Legend on the MFD. If the TAWS-B Page is not displayed at the time, a pop-up alert appears on the MFD. To acknowledge the pop-up alert:

- Press the **CLR** Key (returns to the currently viewed page), or
- Press the **ENT** Key (accesses the TAWS-B Page)

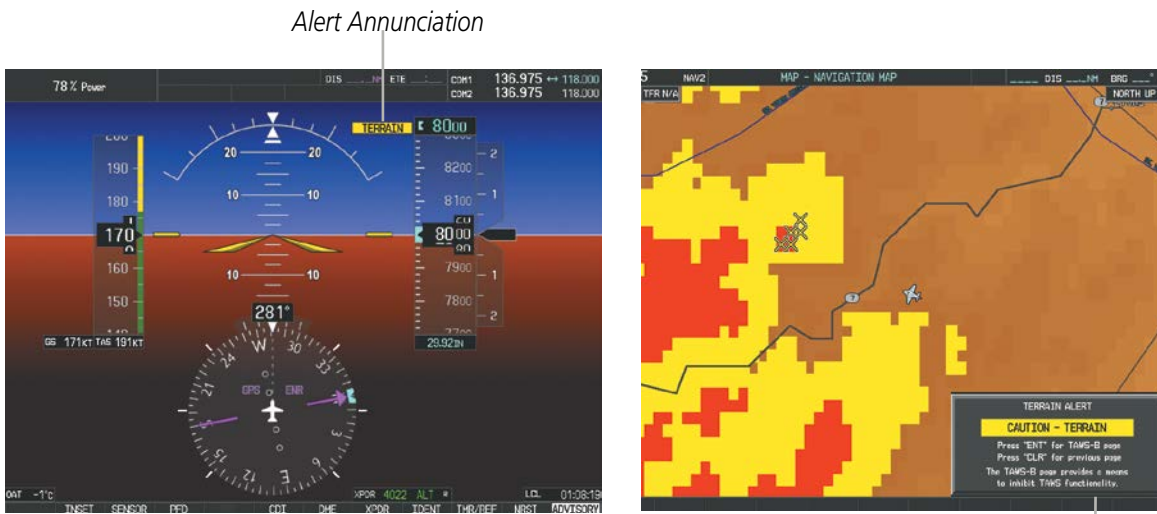

Figure 6-155 TAWS-B Alert Annunciations

Pop-up Alert

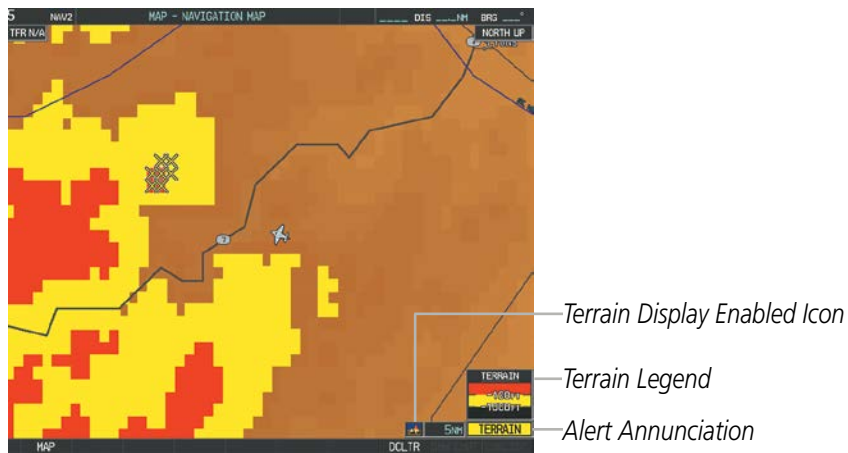

Figure 6-156 Navigation Map Page (After TAWS-B Pop-up Alert Acknowledgment)

Alert Type	PFD/MFD** Alert Annunciation	MFD Pop-Up Alert (except TAWS-B Page)	Voice Alert
Excessive Descent Rate Warning (EDR)	PULL UP	PULL-UP	"Pull Up"
Reduced Required Terrain Clearance Warning (RTC)	PULL UP	TERRAIN - PULL-UP * or TERRAIN AHEAD - PULL-UP	"Terrain, Terrain; Pull Up, Pull Up" * or "Terrain Ahead, Pull Up; Terrain Ahead, Pull Up"
Imminent Terrain Impact Warning (ITI)	PULL UP	TERRAIN - PULL-UP or TERRAIN AHEAD - PULL-UP *	"Terrain, Terrain; Pull Up, Pull Up" or "Terrain Ahead, Pull Up; Terrain Ahead, Pull Up" *
Reduced Required Obstacle Clearance Warning (ROC)	PULL UP	OBSTACLE - PULL-UP * or OBSTACLE AHEAD - PULL-UP	"Obstacle, Obstacle; Pull Up, Pull Up" * or "Obstacle Ahead, Pull Up; Obstacle Ahead, Pull Up"
Imminent Obstacle Impact Warning (IOI)	PULL UP	OBSTACLE - PULL-UP or OBSTACLE AHEAD - PULL-UP *	"Obstacle, Obstacle; Pull Up, Pull Up" or "Obstacle Ahead, Pull Up; Obstacle Ahead, Pull Up" *
Reduced Required Terrain Clearance Caution (RTC)	TERRAIN	CAUTION - TERRAIN * or TERRAIN AHEAD	"Caution, Terrain; Caution, Terrain" * or "Terrain Ahead; Terrain Ahead"
Imminent Terrain Impact Caution (ITI)	TERRAIN	CAUTION - TERRAIN or TERRAIN AHEAD *	"Caution, Terrain; Caution, Terrain" or "Terrain Ahead; Terrain Ahead" *
Reduced Required Obstacle Clearance Caution (ROC)	TERRAIN	CAUTION - OBSTACLE * or OBSTACLE AHEAD	"Caution, Obstacle; Caution, Obstacle" * or "Obstacle Ahead; Obstacle Ahead"
Imminent Obstacle Impact Caution (IOI)	TERRAIN	CAUTION - OBSTACLE or OBSTACLE AHEAD *	"Caution, Obstacle; Caution, Obstacle" or "Obstacle Ahead; Obstacle Ahead" *
Premature Descent Alert Caution (PDA)	TERRAIN	TOO LOW - TERRAIN	"Too Low, Terrain"
Altitude Callout (VCO) "500" "600"	None	None	"Five-Hundred" "Six-Hundred"
Excessive Descent Rate Caution (EDR)	TERRAIN	SINK RATE	"Sink Rate"
Negative Climb Rate Caution (NCR)	TERRAIN	DON'T SINK * or TOO LOW - TERRAIN	"Don't Sink" * or "Too Low, Terrain"

* Alerts with multiple messages are configurable at installation and are installation-dependent. Alerts for the default configuration when more than one option is available are indicated with asterisks.

** Annunciation is displayed on the MFD when terrain display is enabled.

Table 6-23 TAWS-B Alerts Summary

EXCESSIVE DESCENT RATE ALERT

The purpose of the **Excessive Descent Rate (EDR)** alert is to provide notification when the aircraft is determined to be closing (descending) upon terrain a rate that is calculated to be excessive relative to height above terrain. Figure 6-157 shows the parameters for the alert as defined by TSO-C151b.

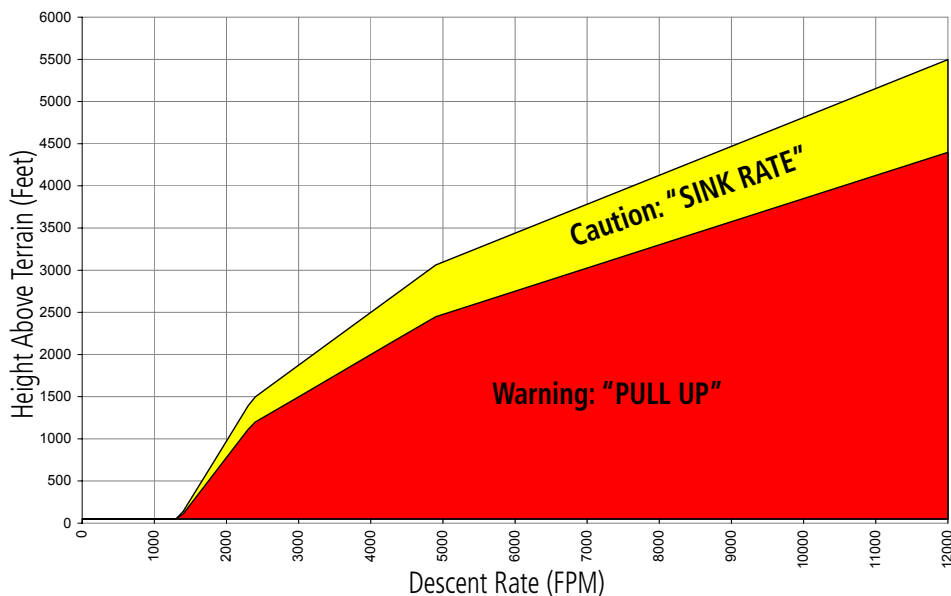

Figure 6-157 Excessive Descent Rate Alert Criteria

FORWARD LOOKING TERRAIN AVOIDANCE

The Forward Looking Terrain Avoidance (FLTA) feature of TAWS-B compares the projected flight path as derived from GPS data with terrain features and obstacles from the terrain and obstacle databases. The system issues visual and voice alerts when the projected flight path conflicts with terrain or obstacles.

The projected flight path is a calculated area ahead of, to the sides, and below the aircraft. The size of the projected flight path varies based on factors including ground speed (the path ahead is larger when the ground speed is higher), whether the aircraft is level, turning, or descending, and the proximity to the nearest runway along the current track. As the aircraft approaches the runway, the projected flight path becomes narrower until the system automatically disables FLTA alerts or the pilot manually inhibits them.

There are two types of FLTA alerts, Reduced Required Terrain/Obstacle Clearance (RTC or ROC respectively) and Imminent Terrain/Obstacle Impact (ITI or IOI respectively).

Reduced Required Terrain Clearance (RTC) and **Reduced Required Obstacle Clearance (ROC)** alerts are issued when the aircraft flight path is above terrain, yet is projected to come within the minimum clearance values in Figure 6-158. When an RTC alert is issued, a potential impact point is displayed on the TAWS-B Page.

Imminent Terrain Impact (ITI) and **Imminent Obstacle Impact (IOI)** alerts are issued when the aircraft is below the elevation of a terrain or obstacle in the aircraft's projected path. ITI and IOI alerts are accompanied by a potential impact point displayed on the TAWS-B Page. The alert is annunciated when the projected vertical flight path is calculated to come within minimum clearance altitudes in Figure 6-158.

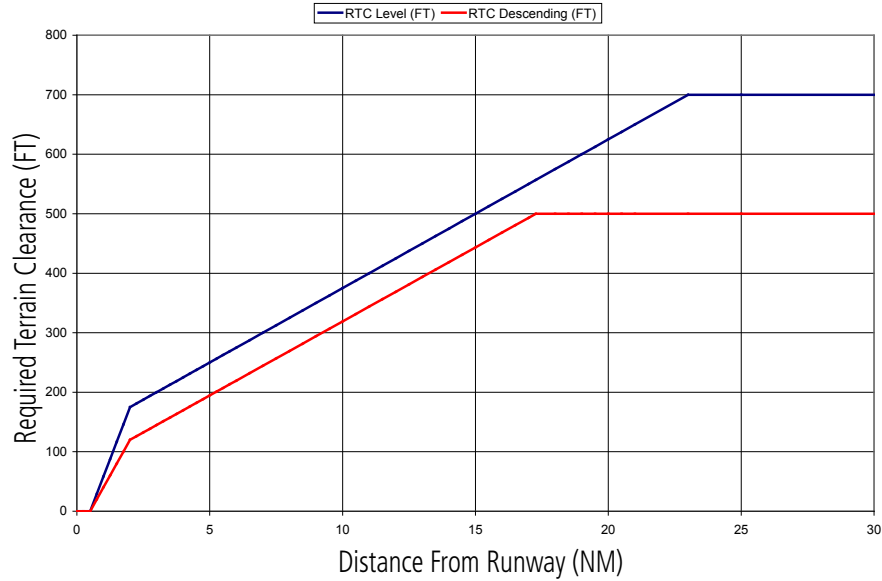

Figure 6-158 FLTA Alert Minimum Terrain and Obstacle Clearance Values

FLTA alerts are automatically inhibited when the aircraft is less than 200 feet above the destination runway elevation while within 0.5 nm of the approach runway or the aircraft is between runway ends.

PREMATURE DESCENT ALERTING

A **Premature Descent Alert (PDA)** is issued when the system detects that the aircraft is significantly below the normal approach path to a runway (Figure 6-159).

PDA alerting begins when the aircraft is within 15 nm of the destination airport and ends when the aircraft is either 0.5 nm from the runway threshold or is at an altitude of 125 feet AGL while within 1.0 nm of the threshold.

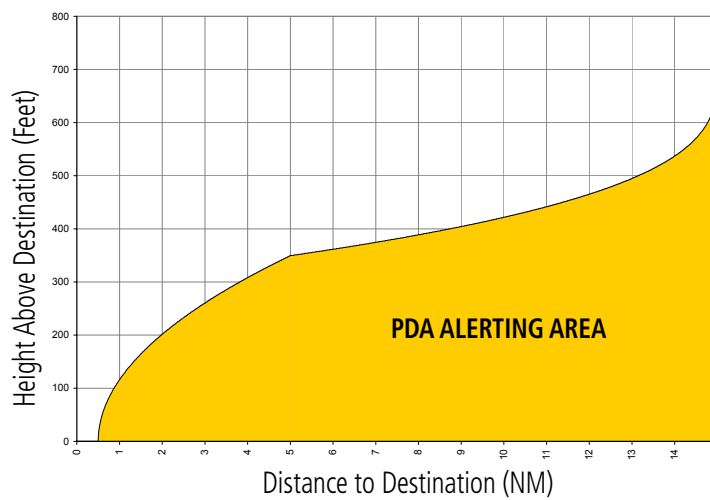

Figure 6-159 PDA Alerting Threshold

The pilot can manually inhibit PDA and FLTA visual annunciations and voice alerts. Discretion should be used when inhibiting TAWS-B alerts, and the system should be enabled when appropriate. When the

TAWS-B system is manually inhibited, the alert annunciation 'TAWS INH' is shown on the PFD and MFD (Figure 6-160).



Figure 6-160 TAWS-B Alerting Disabled
(TAWS-B Inhibited) Annunciation

Inhibiting/enabling TAWS-B alerting:

- 1) Select the TAWS-B Page.
- 2) Press the **INHIBIT** Softkey to inhibit or enable TAWS-B (choice dependent on current state).

Or:

- a) Press the **MENU** Key.
- b) Select 'Inhibit TAWS' or 'Enable TAWS' (choice dependent on current state) and press the **ENT** Key.

While TAWS-B alerting is manually inhibited (or the TAWS-B system is not available or has failed), the system may display a 'LOW ALT' annunciation if the following conditions are met:

- The aircraft is on a GPS SBAS approach.
- The Final Approach Fix is the active waypoint.
- The aircraft is at least 164 feet below the prescribed altitude at the Final Approach Fix.

See the Flight Instruments Section for more details about the 'LOW ALT' annunciation.

VOICE ALERT

The purpose of the voice alert message "**Five-hundred**" is to provide an advisory alert of when the aircraft descends to within 500 feet above the terrain or runway threshold. When the aircraft is within 5 nm of an airport, the "**Five Hundred**" voice alert is based on the nearest runway threshold elevation. When the aircraft is more than 5 nm of the nearest airport, the voice alert is based on the height above terrain as determined using the GSL altitude and terrain database.

NEGATIVE CLIMB RATE AFTER TAKEOFF ALERT (NCR)

The **Negative Climb Rate (NCR) After Takeoff** alert (also referred to as "Altitude Loss After Takeoff") provides alerts when the system determines the aircraft is losing altitude (closing upon terrain) after takeoff. The voice alert "Don't Sink" is given for NCR alerts, accompanied by an annunciation and a pop-up terrain alert on the display. NCR alerting is only active when departing from an airport and when the following conditions are met:

- Height above the terrain is less than 700 feet
- Distance from the departure airport is 5 nm or less
- Heading change from the departure heading is less than 110 degrees

Figures 6-161 and 6-162 shows the NCR alerting parameters as defined by TSO-C151b based on Altitude Loss and Sink Rate respectively.

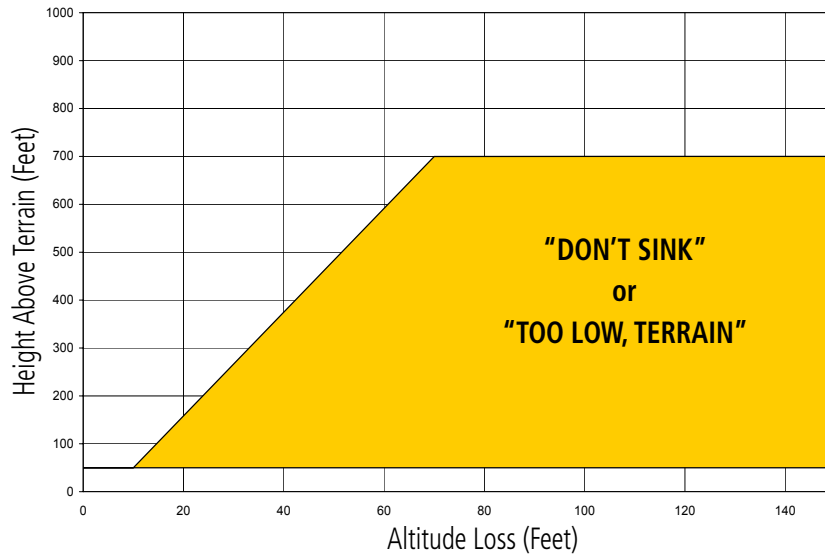

Figure 6-161 Negative Climb Rate (NCR) Altitude Loss

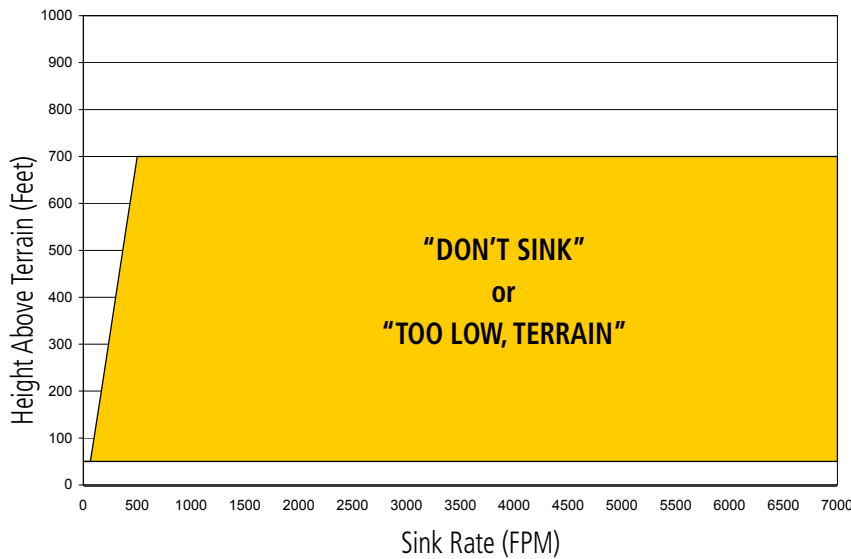

Figure 6-162 Negative Climb Rate (NCR) Sink Rate

SYSTEM STATUS

During power-up, TAWS-B conducts a system test of its alerting capabilities. The system test can also be manually initiated. A single chime is issued at test completion. TAWS-B system testing is disabled when ground speed exceeds 30 knots.

System Condition	PFD/MFD Alert Annunciation	TAWS-B Page Annunciation	Voice Alert
System Test in Progress	TAWS TEST	TAWS TEST	None
System Test Pass	None	None	Single Chime
TAWS System Test Fail	TAWS FAIL	TAWS FAIL	"TAWS System Failure"

Table 6-24 TAWS-B System Test Status Annunciations

Manually testing the TAWS-B System:

- 1) Select the TAWS-B Page.
- 2) Press the **MENU** Key (Figure 6-163).
- 3) Select 'Test TAWS System' and press the **ENT** Key to confirm the selection.

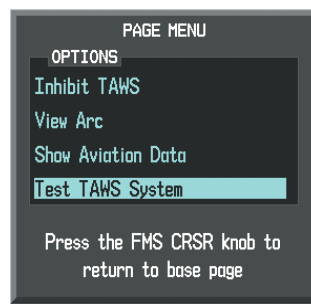

Figure 6-163 TAWS-B Page Menu

TAWS-B continually monitors several system-critical items such as database validity, hardware status, and GPS status. If the terrain/obstacle database is not available, the voice alert "**TAWS System Failure**" is generated along with the 'TAWS FAIL' alert annunciation.

TAWS-B requires a 3-D GPS navigation solution along with specific vertical accuracy minimums. Should the navigation solution become degraded or if the aircraft is out of the database coverage area, the annunciation 'TAWS N/A' is generated in the annunciation window and on the TAWS-B Page. The voice alert "**TAWS Not Available**" is generated. When the GPS signal integrity is restored and the aircraft is within the database coverage area, the voice alert "**TAWS Available**" is generated.

Alert Cause	PFD/MFD Annunciation	TAWS-B Page Annunciation	Voice Alert
MFD Terrain or Obstacle database unavailable or invalid. TAWS operating with PFD Terrain or Obstacle databases	None	TERRAIN DATABASE FAILURE	None
Terrain or Obstacle database unavailable or invalid on all displays, invalid software configuration, TAWS audio fault	TAWS FAIL	TAWS FAIL	"TAWS System Failure"
No GPS position	TAWS N/A	NO GPS POSITION	"TAWS Not Available" "TAWS Available" when GPS position returns.
Excessively degraded GPS signal	TAWS N/A	None	"TAWS Not Available" "TAWS Available" when sufficient GPS signal is received.
Out of database coverage area	TAWS N/A	None	"TAWS Not Available" "TAWS Available" when aircraft enters database coverage area.

Table 6-25 TAWS-B Abnormal Conditions

6.8 PROFILE VIEW TERRAIN

The Perspective® offers a Profile View of terrain and obstacles relative to the aircraft's current flight path and altitude on the Navigation Map Page of the MFD. Profile View does not provide terrain or obstacle caution or warning annunciations or voice alerts, nor does it display potential impact points inside the Profile View. The colors and symbols in Figure 6-164 and Table 6-26 are used to represent terrain and obstacles.

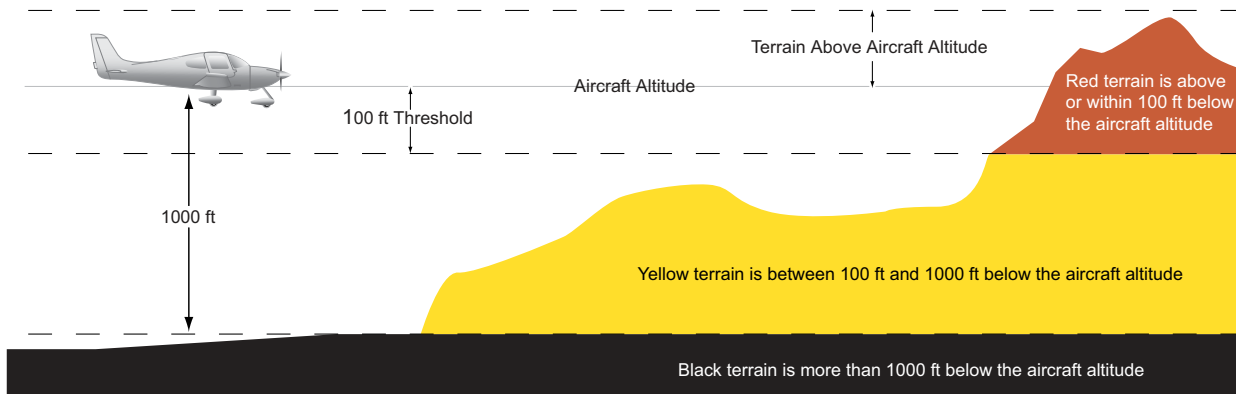

Figure 6-164 Terrain Altitude/Color Correlation for Profile View

Unlighted Obstacle		Lighted Obstacle		Obstacle Location
< 1000' AGL	> 1000' AGL	< 1000' AGL	> 1000' AGL	
				Red obstacle is above or within 100 ft below the aircraft altitude
				Yellow obstacle is between 100 ft and 1000 ft below the aircraft altitude
				Gray obstacle is more than 1000 ft below aircraft altitude

Table 6-26 Profile View Obstacle Colors and Symbology

Enabling/Disabling Profile View:

- 1) Select the Navigation Map Page.
- 2) Select the **MAP** Softkey.
- 3) Select the **PROFILE** Softkey to enable or disable Profile View.

Or:

- 1) Press the **MENU** Key.
- 2) Select 'Show Profile View' or 'Hide Profile View' (choice dependent on current state) and press the **ENT** Key.

Enabling/Disabling Terrain on the Profile View

- 1) Select the Navigation Map Page.
- 2) Select the **MAP** Softkey.
- 3) Select the **TERRAIN** Softkey.

PROFILE VIEW DISPLAY

When the Profile View is enabled, it is displayed in a window below the Navigation Map. Altitude is shown along a vertical scale, with an aircraft icon positioned at the current altitude. Distance is represented horizontally along the bottom of the Profile View, and increases from left (present position) to right.

When the Navigation Map range is adjusted with the **Joystick**, the horizontal distance of the Profile View is adjusted proportionately to be 1/2 of the Navigation Map range distance down to 1 nm, at which point Profile View is no longer available ('PROFILE NOT AVAILABLE' is displayed). When Navigation Map range is adjusted to remove altitude-correlated colored terrain data (as shown in the Terrain Legend) or obstacles from the Navigation Map, these items are also removed from the Profile View; only an outline of the terrain will be displayed in black in the Profile View window. Refer to the applicable Terrain Proximity, Terrain-SVS, or TAWS-B discussions for more information about displaying terrain or obstacles on the Navigation Map Page.

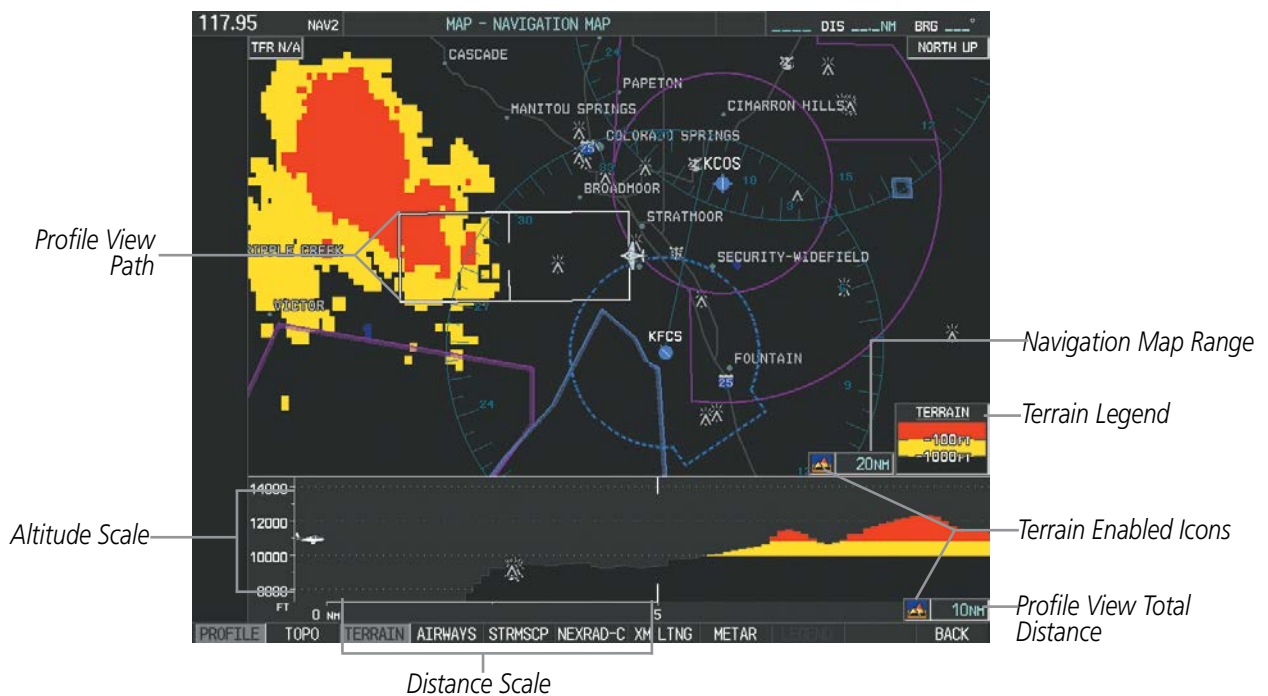

Figure 6-165 Navigation Map Page with Profile View and Terrain Enabled

Obstacles with heights greater than 200 feet AGL appear relative to aircraft altitude along the altitude scale. The top of the obstacle symbol on the scale represents the obstacle's height AGL. If the obstacle's height AGL is higher than can be represented by the obstacle symbol itself (e.g. for unusually tall obstacles), a vertical line appears below the obstacle symbol in order to depict the top of the obstacle symbol at its height AGL, as shown in Figure 6-166.

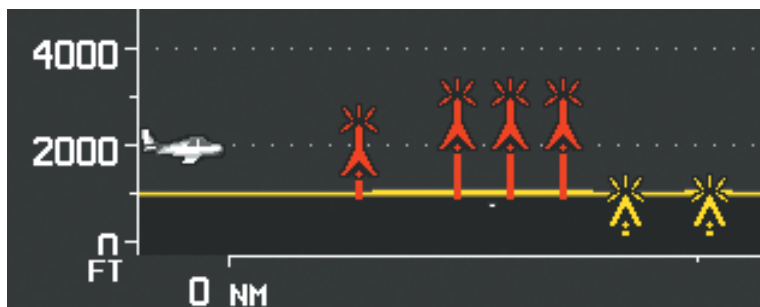

Figure 6-166 Profile View with Tall Obstacles

The Profile View is based on the current aircraft track (or heading if track is unavailable) and shows the *highest* known terrain or obstacles within a predetermined width from the present aircraft position to the end of the profile range. The width of the Profile View (Table 6-27) is determined by the phase of flight, as annunciated on the HSI. Refer to the Flight Instruments section for more information about flight phases.

Flight Phase	Total Profile View Width
Approach	0.6 nm
Departure	0.6 nm
Terminal	2.0 nm
Enroute	4.0 nm
Oceanic	4.0 nm

Table 6-27 Profile View Width Scale

PROFILE PATH

The Profile Path displays the horizontal and lateral boundaries of the Profile View. The path is shown as a white rectangle on the Navigation Map Page (Figure 6-165) and is only available when Profile View is enabled. White range markers appearing on both edges of the Profile Path rectangle match the range markers along the distance scale inside the Profile View display window whenever the profile range is at least 4 nm (or 7.5 km if configured for metric units).

The Profile Path rectangle may be configured on or off, and the Navigation Map range at which the Profile Path is removed from map display can be changed.

Customizing the Profile Path display on the Navigation Map Page:

- 1) Select the Navigation Map Page.
- 2) Press the **MENU** Key.
- 3) With 'Map Setup' highlighted, press the **ENT** Key (Figure 6-167).
- 4) Turn the small **FMS** Knob to select the 'Profile' Group and press the **ENT** Key (Figure 6-168).
- 5) Turn the large **FMS** Knob or press the **ENT** Key to scroll through product selections (Figure 6-169).
 - PROFILE PATH – Turns the display of the Profile Path on or off and sets maximum map range at which the Profile Path is shown
- 6) Turn the small **FMS** Knob to scroll through options (ON/OFF, range settings).
- 7) Press the **ENT** Key to select an option.
- 8) Push the **FMS** Knob or **CLR** Key to return to the Navigation Map Page with the changed settings.

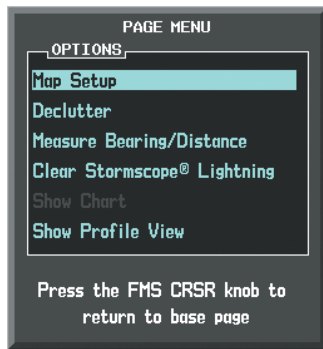

Figure 6-167 Navigation Map Page Menu

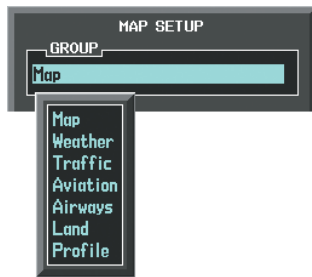

Figure 6-168 Navigation Map Page Setup Menu

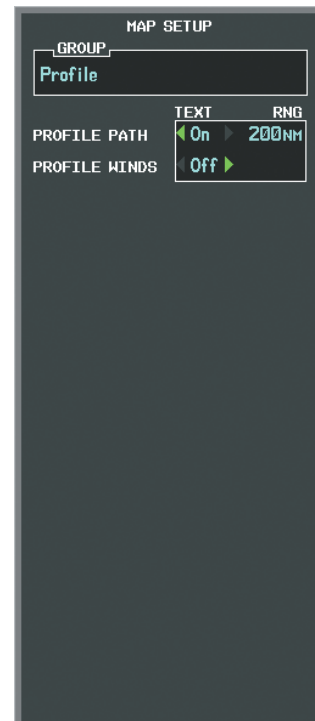

Figure 6-169 Navigation Map Page Setup Menu, Profile Group

6.9 GARMIN GTS 800 TRAFFIC



WARNING: Do not rely solely upon the display of traffic information for collision avoidance maneuvering. The traffic display does not provide collision avoidance resolution advisories and does not under any circumstances or conditions relieve the pilot's responsibility to see and avoid other aircraft.



WARNING: Do not rely solely upon the display of traffic information to accurately depict all of the traffic within range of the aircraft. Due to lack of equipment, poor signal reception, and/or inaccurate information from aircraft or ground stations, traffic may be present that is not represented on the display.



NOTE: Pilots should be aware of TAS system limitations. TAS systems require transponders of other aircraft to respond to system interrogations. If the transponders do not respond to interrogations due to phenomena such as antenna shading or marginal transponder performance, traffic may be displayed intermittently, or not at all. Aircraft without altitude reporting capability are shown without altitude separation data or climb descent indication. Pilots should remain vigilant for traffic at all times.



NOTE: The nose of the 'own ship' symbol represents the location of the aircraft. The center of any traffic symbol represents the location of that traffic. The traffic and own ship symbols are an abstract representation and do not reflect the physical extend of the aircraft/traffic, and should not replace other methods for identifying traffic.

The optional Garmin GTS 800 is a Traffic Advisory System (TAS). The system enhances flight crew situational awareness by displaying traffic information for detected transponder-equipped aircraft. The system also provides visual annunciations and voice traffic alerts to assist the pilot in visually acquiring traffic.

The GTS 800 is capable of tracking a total of 45 intruding aircraft equipped with Mode A, C, or S transponders. The system can display a maximum of 30 aircraft with the highest threat potential simultaneously.

THEORY OF OPERATION

When the system is in Operating Mode, the TAS unit interrogates the transponders of intruding aircraft while monitoring transponder replies. The system uses this information to derive the distance, relative bearing, and if reported, the altitude and vertical trend for each aircraft within its surveillance range.

The system then calculates a closure rate to each intruder based on the projected Closest Point of Approach (CPA). If the closure rate meets the threat criteria for a Traffic Advisory (TA), visual and voice alerting is provided.

TAS SURVEILLANCE VOLUME AND SYMBOLOGY

The GTS 800 TAS monitors the airspace within $\pm 10,000$ feet of own altitude, and up to 22w nm in the forward direction. TAS range is somewhat reduced to the sides and aft of own aircraft due to the directional interrogation signal patterns. The system displays TAS-detected traffic using the symbology shown in Table 6-28.

In addition, if a 1090 MHz extended squitter transponder is installed, and the GTS 800 detects airborne traffic providing 1090 MHz Automatic Dependent Surveillance - Broadcast (ADS-B) information, the system will display the TAS traffic using the ADS-B symbology shown in Table 6-29.



NOTE: Do not confuse this functionality with full ADS-B capability, which can provide traffic information from ADS-B Ground-Based Transceivers (GBTs) and ADS-B traffic outside of the TAS surveillance volume. This system is limited to displaying ADS-B information from suitably equipped airborne aircraft within the TAS surveillance volume.





TAS Symbol	Description
	Non-Threat Traffic
	Proximity Advisory (PA)
	Traffic Advisory (TA)
	Traffic Advisory Off Scale

Table 6-28 TAS Symbol Description





Symbol	Description
	Traffic Advisory with ADS-B directional information. Points in the direction of the intruder aircraft track.
	Proximity Advisory with ADS-B directional information. Points in the direction of the aircraft track.
	Non-threat traffic with ADS-B directional information. Points in the direction of the intruder aircraft track.
	Traffic with ADS-B directional information, but positional accuracy is degraded. Points in the direction of the aircraft track.

Table 6-29 TAS Traffic with ADS-B Symbology

A Traffic Advisory (TA), displayed as an amber circle or triangle, alerts the crew to a potentially hazardous intruding aircraft, if the closing rate, distance, and vertical separation meet TA criteria. A Traffic Advisory that is beyond the selected display range (off scale) is indicated by a half TA symbol at the edge of the screen at the relative bearing of the intruder.

A Proximity Advisory (PA), displayed as a solid white diamond or triangle, indicates the intruding aircraft is within ± 1200 feet and is within a 6 nm range, but is still not considered a TA threat.

A Non-threat Advisory, shown as an open white diamond or triangle, is displayed for all other traffic beyond 6 nm that is neither a TA or PA.

Relative altitude, when available, is displayed above or below the corresponding intruder symbol in hundreds of feet. When this altitude is above own aircraft, it is preceded by a '+' symbol; a minus sign '-' indicates traffic is below own aircraft.

A vertical trend arrow to the right of the intruder symbol indicates traffic is climbing or descending at least 500 feet per minute with an upward or downward-pointing arrow respectively.

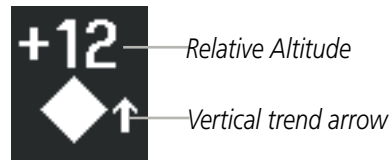

Figure 6-170 Intruder Altitude and Vertical Trend Arrow

If the intruding aircraft is providing ADS-B track information, this is displayed as a vector line extending beyond the traffic symbol in the direction of the track.

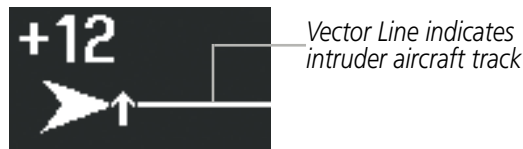

Figure 6-171 Intruder Traffic with ADS-B Directional Information and Track

The traffic system automatically suppresses the display of on-ground aircraft equipped with Mode S transponders.

TA ALERTING CONDITIONS

The traffic system automatically adjusts its TA sensitivity level to reduce the likelihood of nuisance TA alerting during flight phases likely to be near airports. Level A (less) TA sensitivity is used when the aircraft's groundspeed is below 120 knots or when the flaps are down. In all other conditions while the traffic system is providing surveillance, Level B (greater) TA sensitivity is used to assess TA threats.

Sensitivity Level	Intruder Altitude Available	TA Alerting Conditions
A	Yes	Intruder closing rate provides less than 20 seconds of vertical and horizontal separation. Or: Intruder closing rate provides less than 20 seconds of horizontal separation and vertical separation is within 600 feet. Or: Intruder range is within 0.2 nm and vertical separation is within 600 feet.
A	No	Intruder closing rate provides less than 15 seconds of separation.
B	Yes	Intruder closing rate provides less than 30 seconds of vertical and horizontal separation. Or: Intruder closing rate provides less than 30 seconds of horizontal separation and vertical separation is within 800 feet. Or: Intruder range is within 0.55 nm and vertical separation is within 800 feet.
B	No	Intruder range is less than 20 seconds.

Table 6-30 TA Sensitivity Level and TA Alerting Criteria

TAS ALERTS



NOTE: Voice traffic alerts do not occur when the flaps are down. Only visual traffic annunciations are issued under this condition.

When the traffic system detects a new TA, the following occur:

- A single **“Traffic!”** voice alert is generated, followed by additional voice information about the bearing, relative altitude, and approximate distance from the intruder that triggered the TA (Table 6-30). The announcement **“Traffic! 12 o’clock, high, four miles,”** would indicate the traffic is in front of own aircraft, above own altitude, and approximately four nautical miles away.
- A TRAFFIC Annunciation appears at the top right of the airspeed on the PFD, flashing for five seconds and remains displayed until no TAs are detected in the area (Figure 6-172).
- The PFD Inset Map is automatically displayed with TA traffic.

If the bearing of TA traffic cannot be determined (Figures 6-174 and 6-177), an amber text banner will be displayed in the center of the Traffic Map Page and in the lower-left of the PFD inset map instead of a TA symbol. The text will indicate “TA” followed by the distance, relative altitude, and vertical trend arrow for the TA traffic, if known.

A TA will be displayed for at least eight seconds, even if the condition(s) that initially triggered the TA are no longer present.

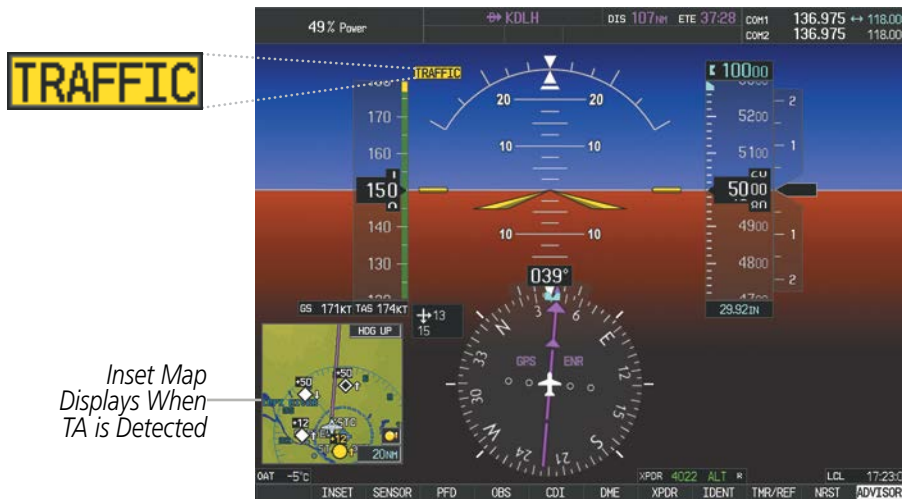

Figure 6-172 Traffic Annunciation (PFD)

Bearing	Relative Altitude	Distance (nm)
“One o’clock” through “Twelve o’clock” or “No Bearing”	“High”, “Low”, “Same Altitude” (if within 200 feet of own altitude), or “Altitude not available”	“Less than one mile”, “One Mile” through “Ten Miles”, or “More than ten miles”

Table 6-30 TA Descriptive Voice Announcements

SYSTEM TEST

NOTE: Traffic surveillance is not provided during the system test. Use caution when performing a system test during flight.

The traffic system provides a system test mode to verify the TAS system is operating normally. The test takes approximately ten seconds to complete. When the system test is initiated, a test pattern of traffic symbols is displayed on the Traffic Map Page (Figure 6-173). If the system test passes, the system announces “**TAS System Test Passed**”, otherwise the system announces “**TAS System Test Failed.**” When the system test is complete, the unit enters Standby Mode.

Testing the Traffic System:

- 1) Turn the large **FMS** Knob to select the Map Page Group.
- 2) Turn the small **FMS** Knob to select the Traffic Map Page.
- 3) Turn the **Joystick** to set the range to 2/6 nm to allow for full test pattern display as shown in the figure below.
- 4) Press the **TEST** Softkey.

Or:

- 1) Press the **MENU** Key and turn the small **FMS** knob to select 'Test Mode'.
- 2) Press the **ENT** Key.

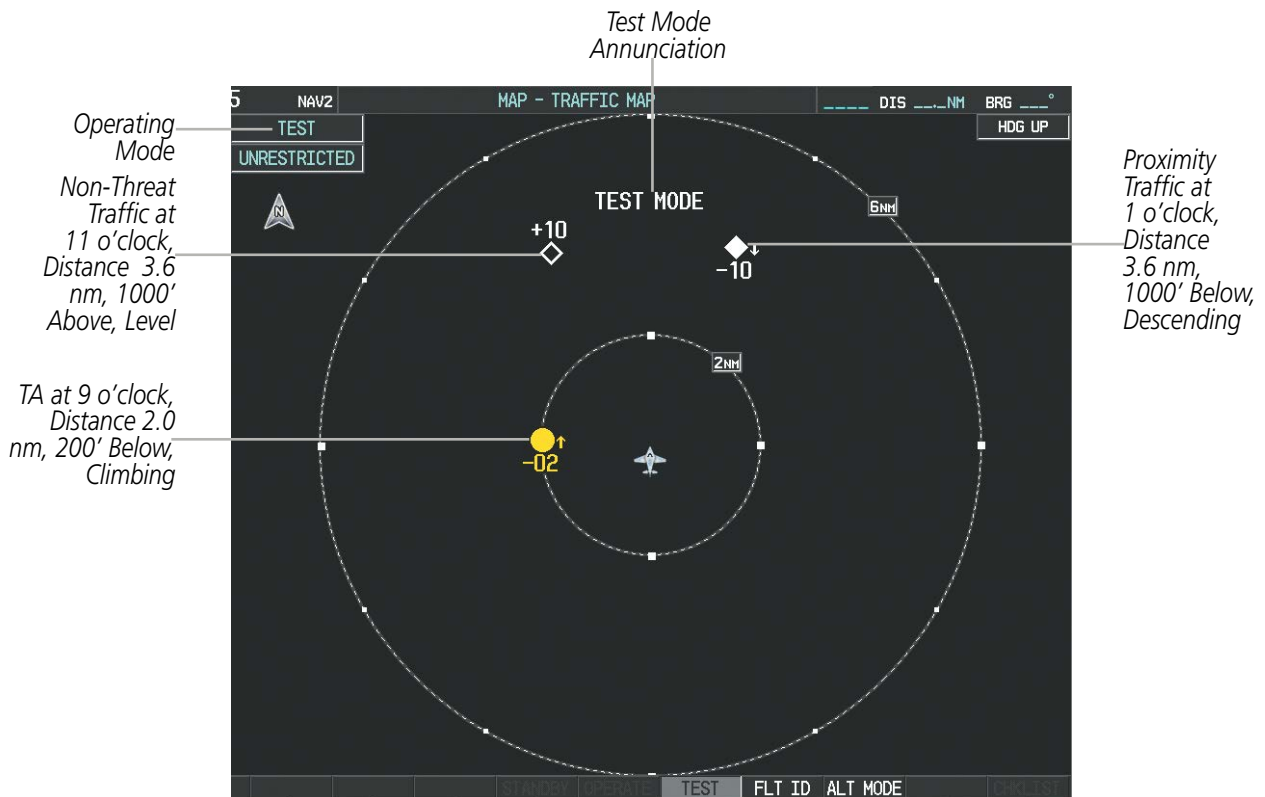

Figure 6-173 System Test in Progress with Test Pattern

OPERATION



NOTE: The traffic unit automatically transitions from **STANDBY** to **OPERATE** mode eight seconds after takeoff. The unit also automatically transitions from **OPERATE** to **STANDBY** mode 24 seconds after landing.

After power-up, the traffic system is in Standby Mode. The traffic unit must be in Operating Mode for traffic to be displayed and for TAs to be issued.

Pressing the **OPERATE** Softkey allows the system to switch from Standby Mode to Operating Mode as necessary. Pressing the **STANDBY** Softkey forces the unit into Standby Mode.

Switching from operating mode to standby mode:

On the Traffic Page, press the **STANDBY** Softkey

Or:

- 1) Press the **MENU** Key and turn the small **FMS** knob to select 'Standby Mode'.
- 2) Press the **ENT** Key.

Switching from standby mode to operating mode:

On the Traffic Page, press the **OPERATE** Softkey

Or:

- 1) Press the **MENU** Key and turn the small **FMS** knob to select 'Operate Mode'.
- 2) Press the **ENT** Key. The traffic system switches from Standby Mode to Operating Mode as necessary.

TRAFFIC MAP PAGE

The Traffic Map Page (Figure 6-174) shows surrounding TAS traffic data in relation to the aircraft's current position and altitude, without basemap clutter. Aircraft orientation is always heading up unless there is no valid heading. Map range is adjustable with the **Joystick** up to 12 nm, as indicated by the map range rings.

The traffic mode and altitude display mode are annunciated in the upper left corner of the page.

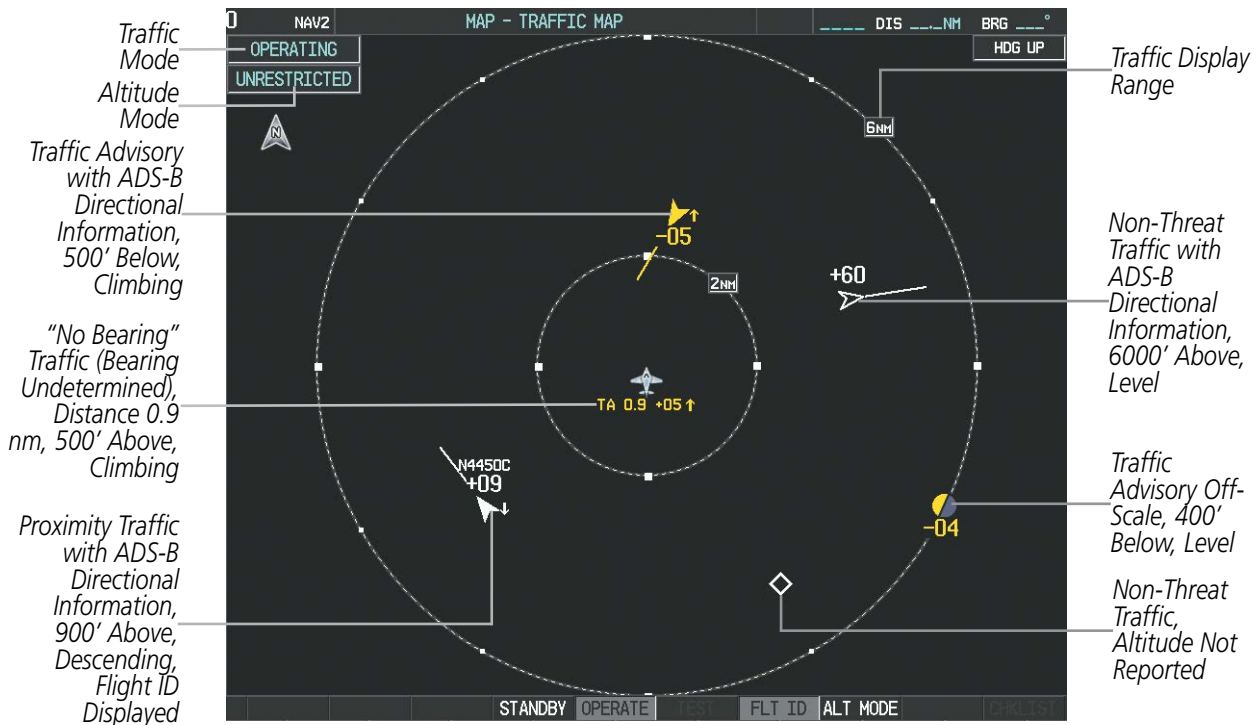

Figure 6-174 Traffic Map Page

Displaying traffic on the Traffic Map Page:

- 1) Turn the large **FMS** Knob to select the Map Page Group.
- 2) Turn the small **FMS** Knob to select the Traffic Map Page.
- 3) Press the **OPERATE** Softkey to begin displaying traffic. 'OPERATING' is displayed in the Traffic mode field.
- 4) Press the **STANDBY** Softkey to place the system in the Standby mode. 'STANDBY' is displayed in the Traffic Mode field.
- 5) Turn the **Joystick** clockwise to display a larger area or counter-clockwise to display a smaller area.

ALTITUDE DISPLAY

The pilot can select the volume of airspace in which non-threat and proximity traffic is displayed. If the system issues a TA occurring outside of this airspace, it will always be shown.

Changing the altitude range:

- 1) On the Traffic Map Page, select the **ALT MODE** Softkey.
- 2) Press one of the following Softkeys:
 - **ABOVE**: Displays non-threat and proximity traffic from 9000 feet above the aircraft to 2700 feet below the aircraft. Typically used during climb phase of flight.
 - **NORMAL**: Displays non-threat and proximity traffic from 2700 feet above the aircraft to 2700 feet below the aircraft. Typically used during enroute phase of flight.
 - **BELOW**: Displays non-threat and proximity traffic from 2700 feet above the aircraft to 9000 feet below the aircraft. Typically used during descent phase of flight.
 - **UNREST** (unrestricted): All traffic is displayed from 9900 feet above and 9900 feet below the aircraft.
- 3) To return to the Traffic Map Page, press the **BACK** Softkey.

Or:

 - 1) Press the **MENU** Key.
 - 2) Turn the small **FMS** Knob to select one of the following (see Softkey description in previous step 2):
 - ABOVE
 - NORMAL
 - BELOW
 - UNRESTRICTED
 - 3) Press the **ENT** Key.

FLIGHT ID DISPLAY

The Flight IDs of other aircraft (when available) can be enabled for display on the Traffic Map Page (Figure 6-175). When a flight ID is received, it will appear above or below the corresponding traffic symbol on the Traffic Map Page when this option is enabled.

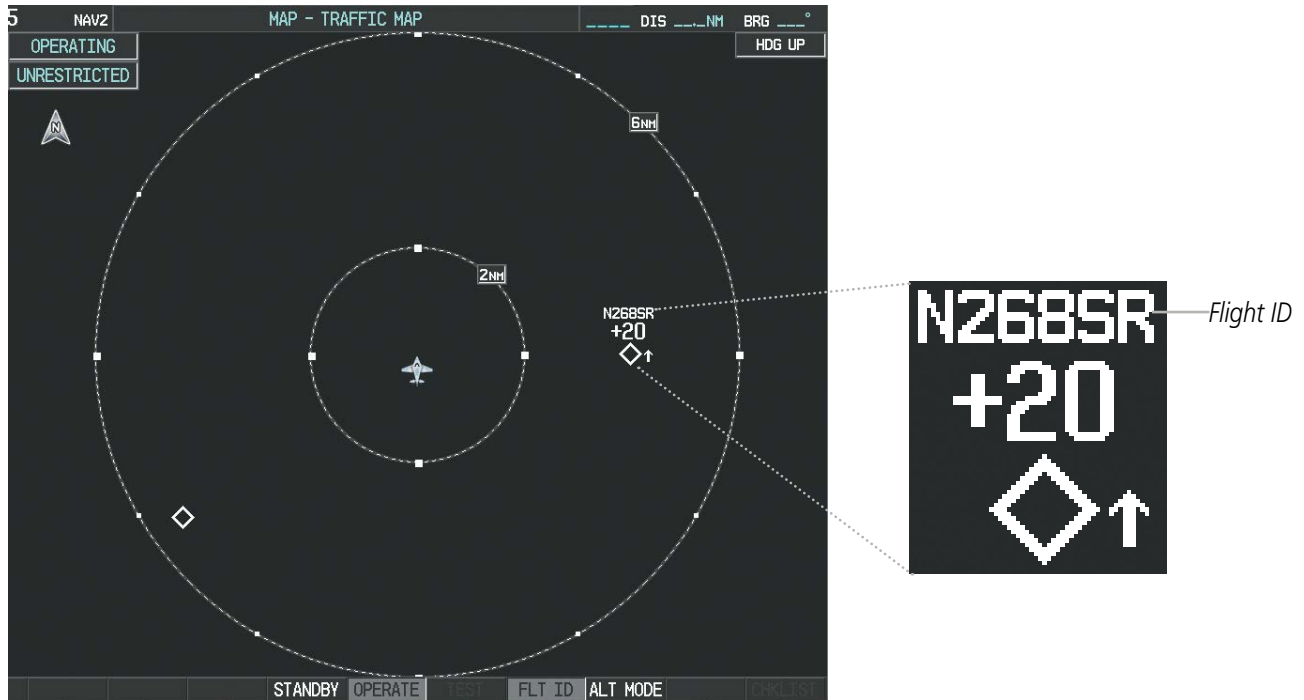

Figure 6-175 Traffic Map Page with Flight IDs Enabled

Enabling/Disabling Flight ID Display:

On the Traffic Map Page, select the **FLT ID** Softkey.

Or:

- 1) Press the **MENU** Key.
- 2) Turn the small **FMS** Knob to select 'Show Flight IDs' or 'Hide Flight IDs' (choice dependent on current state) (Figure 6-176).
- 3) Press the **ENT** Key.

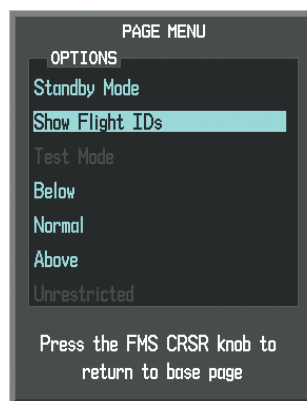

Figure 6-176 Traffic Map Page Menu

TRAFFIC MAP PAGE DISPLAY RANGE

The display range on the Traffic Map Page can be changed at any time. Map range is adjustable with the **Joystick**, as indicated by the map range rings.

Changing the display range on the Traffic Map Page:

- 1) Turn the **Joystick**
- 2) The following range options are available:
 - 2 nm
 - 2 and 6 nm
 - 6 and 12 nm

ADDITIONAL TRAFFIC DISPLAYS

The Traffic Map Page is the principal map page for viewing traffic information. Traffic information is also available on the following other MFD maps and pages as an additional reference to the Traffic Map Page:

- Navigation Map Page
- Nearest Pages
- Trip Planning Page
- Active Flight Plan Page
- AUX - Video Page

Traffic information can also be displayed on the PFD when the Synthetic Vision Technology (SVT) system option is installed and enabled. See the Additional Features Section for details.

Displaying traffic information (MFD maps other than the Traffic Map Page):

- 1) Press the **MAP** Softkey.
- 2) Press the **TRAFFIC** Softkey. Traffic is now displayed on the map.

When traffic is selected on navigation maps, a traffic icon is shown to indicate traffic is enabled for display (Table 6-31).

Displaying traffic on the Navigation Map:

- 1) Ensure the TAS system is operating. With the Navigation Map displayed, press the **MAP** Softkey.
- 2) Press the **TRAFFIC** Softkey. Traffic is now displayed on the map as shown in Figure 6-177.

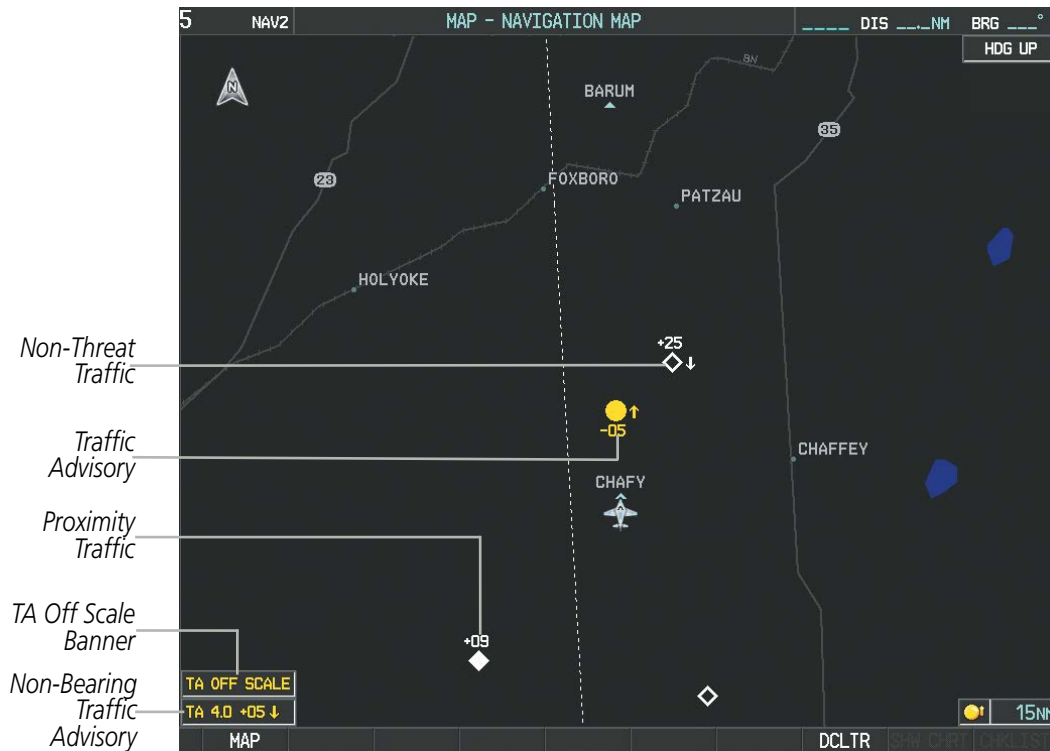

Figure 6-177 TAS Traffic on Navigation Map

Customizing the traffic display on the Navigation Map Page:

- 1) Select the Navigation Map Page.
- 2) Press the **MENU** Key.
- 3) With Map Setup highlighted, press the **ENT** Key (Figure 6-178).
- 4) Turn the small **FMS** Knob to select the Traffic Group and press the **ENT** Key (Figure 6-179).
- 5) Turn the large **FMS** Knob or press the **ENT** Key to scroll through the selections (Figure 6-180).
 - TRAFFIC – Turns the display of traffic data on or off
 - TRAFFIC MODE – Selects the traffic mode for display; select from:
 - All Traffic - Displays all traffic
 - TA/PA - Displays Traffic Advisories and Proximity Advisories
 - TA ONLY - Displays Traffic Advisories only
 - TRAFFIC SMBL – Selects the maximum range at which traffic symbols are shown
 - TRAFFIC LBL – Selects the maximum range at which traffic labels are shown with the option to turn off
- 6) Turn the small **FMS** Knob to scroll through options (ON/OFF, range settings, etc.).
- 7) Press the **ENT** Key to select an option.
- 8) Push the **FMS** Knob or **CLR** Key to return to the Navigation Map Page.



Figure 6-178 Navigation Map Page Menu



Figure 6-179 Navigation Map Page Setup Menu

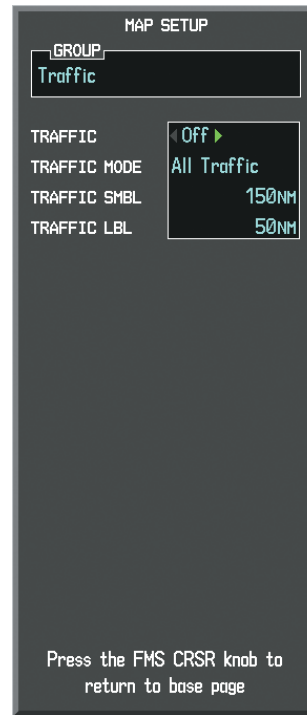

Figure 6-180 Navigation Map Page Setup Menu, Traffic Group

The Navigation Map Page Setup Menu also controls the display of traffic. The setup menu controls the map range settings. Traffic data symbols and labels can be decluttered from the display. If a map range larger than the map range setting is selected, the data is removed from the map. Maps besides the Traffic Map Page use settings based on those selected for the Navigation Map Page.

A traffic inset map may be displayed on the PFD. Traffic information can also be overlaid with navigation, topographic and optional weather data on the PFD inset navigation map

Displaying traffic information (PFD Inset Map):

- 1) Press the **INSET** Softkey.
- 2) Press the **TRAFFIC** Softkey to display traffic data on the inset map (TRFC-1).
- 3) Press the softkey again to display the traffic-only inset (TRFC-2).
- 4) Press the softkey again to remove traffic data.

SYSTEM STATUS

The traffic mode is annunciated in the upper left corner of the Traffic Map Page.

Traffic Mode	Traffic Mode Annunciation (Traffic Map Page)	Traffic Display Status Icon (Other Maps)
TAS System Test Initiated	TEST (also shown in white in center of page)	
TAS Operating	OPERATING	
TAS Standby	STANDBY (also shown in white in center of page)	
TAS Failed*	FAIL	

* See Table 6-32 for additional failure annunciations

Table 6-31 TAS Modes

If the traffic unit fails, an annunciation as to the cause of the failure is shown in the center of the Traffic Map Page. During a failure condition, the Operating Mode cannot be selected.

Traffic Map Page Annunciation	Description
NO DATA	Data is not being received from the TAS unit
DATA FAILED	Data is being received from the TAS unit, but the unit is self-reporting a failure
FAILED	Incorrect data format received from the TAS unit

Table 6-32 TAS Failure Annunciations

The annunciations to indicate the status of traffic information appear in a banner at the lower left corner of maps on which traffic can be displayed.

Traffic Status Banner Annunciation	Description
TA OFF SCALE	A Traffic Advisory is outside the selected display range*. Annunciation is removed when traffic comes within the selected display range.
TA X.X ± XX ↓	System cannot determine bearing of Traffic Advisory**. Annunciation indicates distance in nm, altitude separation in hundreds of feet, and altitude trend arrow (climbing/descending).
TRFC FAIL	TAS unit has failed (unit is self-reporting a failure or sending incorrectly formatted data)
NO TRFC DATA	Data is not being received from the TAS unit

*Shown as symbol on Traffic Map Page

**Shown in center of Traffic Map Page

Table 6-33 TAS Traffic Status Annunciations

6.10 AVIDYNE TAS610 TRAFFIC



WARNING: Do not rely solely upon the display of traffic information for collision avoidance maneuvering. The traffic display does not provide collision avoidance resolution advisories and does not under any circumstances or conditions relieve the pilot's responsibility to see and avoid other aircraft.



WARNING: Do not rely solely upon the display of traffic information to accurately depict all of the traffic within range of the aircraft. Due to lack of equipment, poor signal reception, and/or inaccurate information from aircraft or ground stations, traffic may be present that is not represented on the display.



NOTE: Refer to the Avidyne TAS600 Series Pilot's Operating Handbook for a detailed discussion of the Avidyne TAS610.



NOTE: The nose of the 'own ship' symbol represents the location of the aircraft. The center of any traffic symbol represents the location of that traffic. The traffic and own ship symbols are an abstract representation and do not reflect the physical extend of the aircraft/traffic, and should not replace other methods for identifying traffic.

The TAS610 Traffic Advisory System (TAS) is designed to help in detection and avoidance of other aircraft. TAS uses an on-board interrogator-processor and an altitude reporting transponder for the air-to-air traffic data link.

TAS SYMBOLOGY

Traffic is displayed with the symbols shown below.





TAS Symbol	Description
	Non-Threat Traffic
	Proximity Advisory (PA)
	Traffic Advisory (TA)
	Traffic Advisory Off Scale

Table 6-34 TAS Symbol Description

A Non-threat Advisory, shown as an open white diamond, indicates that an intruding aircraft is at greater than ± 1200 feet relative altitude or the distance is beyond 5 nm.

A Proximity Advisory indicates that the intruding aircraft is within ± 1200 feet and is within 5 nm range, but is still not considered a threat.

A Traffic Advisory (TA) alerts the crew to a potentially hazardous intruding aircraft. Closing rate, distance, and vertical separation meet TA criteria. A Traffic Advisory that is beyond the selected display range is indicated by a half TA symbol at the edge of the screen at the relative bearing of the intruder.

DISPLAYING TRAFFIC INFORMATION

Traffic information is displayed on the following maps:

- PFD Inset Map
- Navigation Map Page
- Traffic Map Page
- Trip Planning Page
- Nearest Pages
- Active Flight Plan Page
- AUX - Video Page

Traffic information can also be displayed on the PFD when the Synthetic Vision Technology (SVT) system option is installed and enabled. See the Additional Features Section for details.

Displaying traffic on the Traffic Map Page:

- 1) Turn the large **FMS** Knob to select the Map Page Group.
- 2) Turn the small **FMS** Knob to select the Traffic Map Page.
- 3) Turn the **Joystick** clockwise to display a larger area or counter-clockwise to display a smaller area.



Figure 6-181 Traffic Map Page

The Traffic Map Page shows surrounding TAS traffic data in relation to the aircraft's current position and altitude, without basemap clutter. Aircraft orientation is always heading up unless there is no valid heading. Map range is adjustable with the **Joystick** from 2 to 24 nm, as indicated by the map range rings.

The traffic mode and altitude display mode are annunciated in the upper left corner.

Displaying traffic information (maps other than the Traffic Map Page):

- 1) Press the **MAP** Softkey.
- 2) Press the **TRAFFIC** Softkey to display traffic data.

When traffic is selected on maps other than the Traffic Map Page, a traffic icon is shown to indicate TAS is enabled for display.

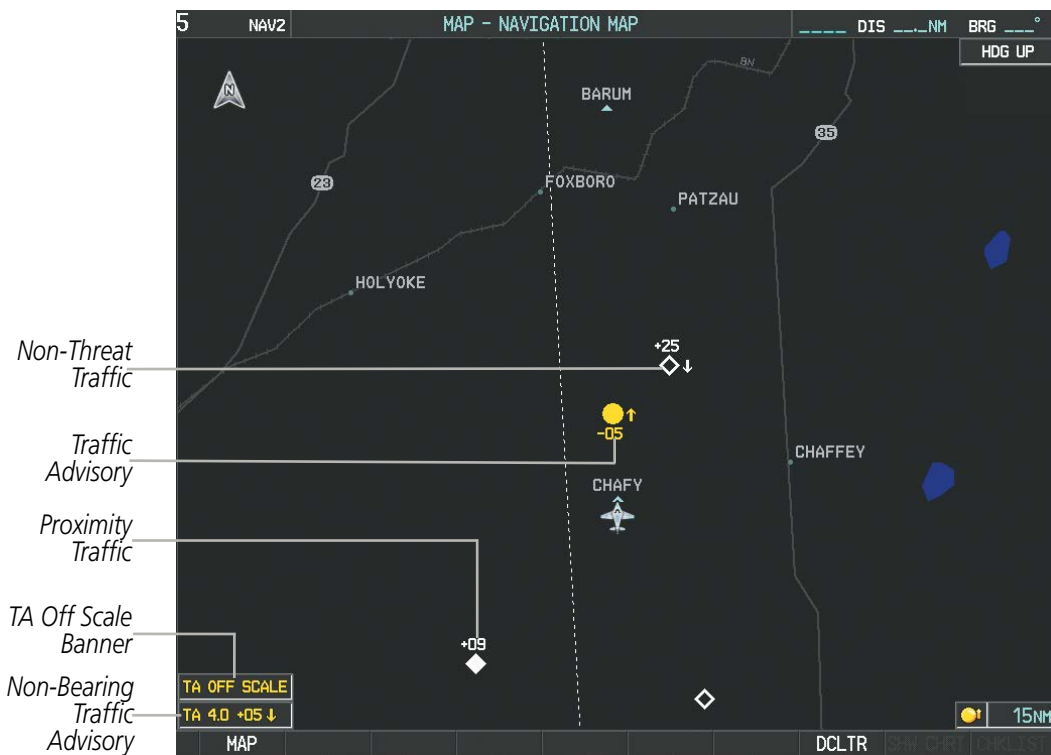

Figure 6-182 TAS Traffic on Navigation Map

Displaying traffic information (PFD Inset Map):

- 1) Press the **INSET** Softkey.
- 2) Press the **TRAFFIC** Softkey to display traffic data on the inset map (TRFC-1).
- 3) Press the softkey again to display the traffic-only inset (TRFC-2).
- 4) Press the softkey again to remove traffic data.

ALTITUDE DISPLAY

Changing the altitude display mode:

- 1) On the Traffic Page, select the **ALT MODE** Softkey.
- 2) Select one of the following Softkeys:
 - **BELOW**
 - **NORMAL**
 - **ABOVE**
 - **UNREST** (unrestricted)
- 3) To return to the Traffic Page, select the **BACK** Softkey.
Or:
 - 1) Press the **MENU** Key.
 - 2) Turn the small **FMS** Knob to select one of the following:
 - **BELOW**
 - **NORMAL**
 - **ABOVE**
 - **UNREST** (unrestricted)
 - 3) Press the **ENT** Softkey.

TRAFFIC MAP PAGE DISPLAY RANGE

The display range on the Traffic Map Page can be changed at any time. Map range is adjustable with the **Joystick** from 2 to 24 nm, as indicated by the map range rings.

Changing the display range on the Traffic Page:

- 1) Turn the **Joystick**.
- 2) The following range options are available:
 - 2 nm
 - 2 and 6 nm
 - 6 and 12 nm
 - 12 and 24 nm

The Navigation Map Page Setup Menu also controls the display of traffic. The setup menu controls the map range settings. Traffic data symbols and labels can be decluttered from the display. If a map range larger than the map range setting is selected, the data is removed from the map. Maps besides the Traffic Map Page use settings based on those selected for the Navigation Map Page.

Customizing the traffic display on the Navigation Map Page:

- 1) Select the Navigation Map Page.
- 2) Press the **MENU** Key.
- 3) With Map Setup highlighted, press the **ENT** Key (Figure 6-183).
- 4) Turn the small **FMS** Knob to select the Traffic Group and press the **ENT** Key (Figure 6-184).
- 5) Turn the large **FMS** Knob or press the **ENT** Key to scroll through the selections (Figure 6-185).
 - TRAFFIC – Turns the display of traffic data on or off
 - TRAFFIC MODE – Selects the traffic mode for display; select from:
 - All Traffic - Displays all traffic
 - TA/PA - Displays Traffic Alerts and Proximity Advisories
 - TA Only - Displays Traffic Alerts only
 - TRAFFIC SMBL – Selects the maximum range at which traffic symbols are shown
 - TRAFFIC LBL – Selects the maximum range at which traffic labels are shown with the option to turn off
- 6) Turn the small **FMS** Knob to scroll through options (ON/OFF, range settings, etc.).
- 7) Press the **ENT** Key to select an option.
- 8) Push the **FMS** Knob or **CLR** Key to return to the Navigation Map Page.



Figure 6-183 Navigation Map Page Menu



Figure 6-184 Navigation Map Page Setup Menu

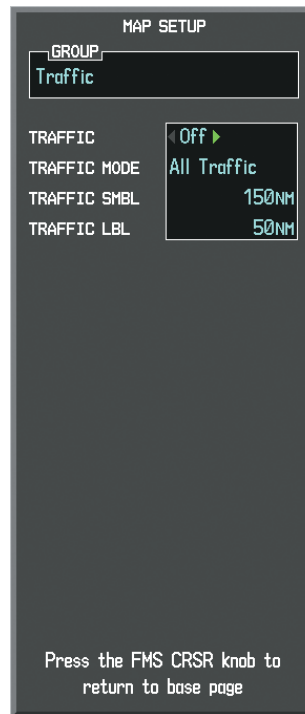

Figure 6-185 Navigation Map Page Setup Menu, Traffic Group

TAS ALERTS

NOTE: Refer to the Avidyne TAS600 Series Pilot's Operating Handbook for information on alerts generated by the TAS equipment.

When the number of TAs on the Traffic Map Page increases from one scan to the next, the following occur:

- A “Traffic” voice alert is generated followed by the clock position, relative altitude and range of the TA.
- A TRAFFIC Annunciation appears at the top right of the airspeed on the PFD, flashing for 5 seconds and remaining displayed until no TAs are detected in the area.
- The PFD Inset Map is automatically displayed with TA traffic.

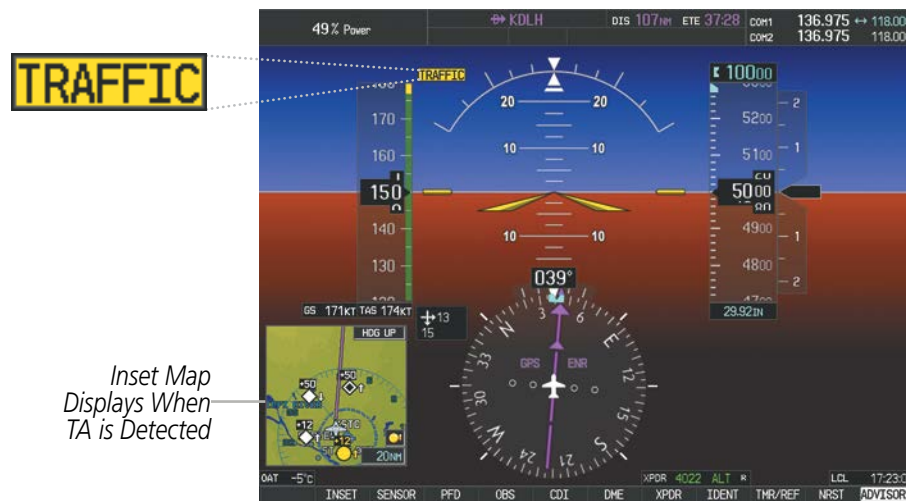

Figure 6-186 Traffic Annunciation (PFD)

TAS VOICE ALERTS

To listen to an update of Traffic Advisories select the **MUTE** Softkey twice.

Muting the TAS voice alert in progress:

- 1) Select the Traffic Map Page.
- 2) Press the **MUTE** Softkey while the voice alert is playing. Subsequent voice alerts will be heard.

SYSTEM STATUS



NOTE: Refer to the Avidyne TAS600 Series Pilot's Operating Handbook for information on the operating mode.

The traffic mode is annunciated in the upper left corner of the Traffic Map Page.

Traffic Mode	Traffic Mode Annunciation (Traffic Map Page)	Traffic Display Status Icon (Other Maps)
TAS Operating	OPERATING	
TAS Failed*	FAIL	

* See Table 6-36 for additional failure annunciations

Table 6-35 TAS Modes

If the unit fails, an annunciation as to the cause of the failure is shown in the center of the Traffic Map Page.

Traffic Map Page Annunciation	Description
NO DATA	Data is not being received from the TAS unit
DATA FAILED	Data is being received from the TAS unit, but the unit is self-reporting a failure
FAILED	Incorrect data format received from the TAS unit

Table 6-36 TAS Failure Annunciations

The annunciations to indicate the status of traffic information appear in a banner at the lower left corner of maps on which traffic can be displayed.

Traffic Status Banner Annunciation	Description
TA OFF SCALE	A Traffic Advisory is outside the selected display range* Annunciation is removed when traffic comes within the selected display range
TA X.X ± XX ↓	System cannot determine bearing of Traffic Advisory** Annunciation indicates distance in nm, altitude separation in hundreds of feet, and altitude trend arrow (climbing/descending)
TRFC FAIL	TAS unit has failed (unit is self-reporting a failure or sending incorrectly formatted data)
NO TRFC DATA	Data is not being received from the TAS unit

*Shown as symbol on Traffic Map Page

**Shown in center of Traffic Map Page

Table 6-37 TAS Traffic Status Annunciations

6.11 L-3 SKYWATCH TRAFFIC

 **WARNING:** Do not rely solely upon the display of traffic information for collision avoidance maneuvering. The traffic display does not provide collision avoidance resolution advisories and does not under any circumstances or conditions relieve the pilot's responsibility to see and avoid other aircraft.

 **WARNING:** Do not rely solely upon the display of traffic information to accurately depict all of the traffic within range of the aircraft. Due to lack of equipment, poor signal reception, and/or inaccurate information from aircraft or ground stations, traffic may be present that is not represented on the display.

 **NOTE:** Refer to the SKYWATCH® (SKY497) Pilot's Guide for a detailed discussion of the SKY497 TAS.

 **NOTE:** The nose of the 'own ship' symbol represents the location of the aircraft. The center of any traffic symbol represents the location of that traffic. The traffic and own ship symbols are an abstract representation and do not reflect the physical extend of the aircraft/traffic, and should not replace other methods for identifying traffic.

The SKYWATCH Traffic Advisory System (TAS) is designed to help in detection and avoidance of other aircraft. TAS uses an on-board interrogator-processor and an altitude reporting transponder for the air-to-air traffic data link.

TAS SYMBOLOGY

Traffic is displayed using four different symbols.





TAS Symbol	Description
	Non-Threat Traffic
	Proximity Advisory (PA)
	Traffic Advisory (TA)
	Traffic Advisory Off Scale

Table 6-38 TAS Symbol Description

A Non-threat Advisory, shown as an open white diamond, indicates that an intruding aircraft is at greater than ±1200 feet relative altitude or the distance is beyond 5 nm.

A Proximity Advisory indicates that the intruding aircraft is within ±1200 feet and is within 5 nm range, but is still not considered a threat.

A Traffic Advisory (TA) alerts the crew to a potentially hazardous intruding aircraft. Closing rate, distance, and vertical separation meet TA criteria. A Traffic Advisory that is beyond the selected display range is indicated by a half TA symbol at the edge of the screen at the relative bearing of the intruder.

OPERATION

The unit must be in operating mode for traffic to be displayed. The ability to switch from standby to operating mode on the ground is especially useful for scanning the airspace around the airport before takeoff.

Switching from standby mode to operating mode:

- 1) On the Traffic Page, select the **OPERATE** Softkey or press the **MENU** Key and turn the small **FMS** knob to select Operating Mode.
- 2) If using the FMS menu, press the **ENT** Key to place the SKY497 in the operating mode.
- 3) To switch to Standby Mode from the Traffic Page, press the **STANDBY** Softkey.

Testing the Traffic Advisory System:

- 1) Set the range to 2/6 nm to allow for full traffic test pattern display.
- 2) Press the **STANDBY** Softkey.
- 3) Press the **TEST** Softkey.
- 4) System test takes approximately eight seconds to complete. When completed successfully, traffic symbols display and a voice alert "Traffic Advisory System Test Passed" is heard. If the system test fails, the system reverts to Standby Mode and a voice alert "Traffic Advisory System Test Failed" is heard.

DISPLAYING TRAFFIC INFORMATION

Traffic information can be displayed on the following maps when the SKY497 unit is operating:

- PFD Inset Map
- Nearest Pages
- Navigation Map Page
- Active Flight Plan Page
- Traffic Map Page
- AUX - Video Page
- Trip Planning Page

Traffic information can also be displayed on the PFD when the Synthetic Vision Technology (SVT) system option is installed and enabled. See the Additional Features Section for details.

Displaying traffic on the Traffic Map Page:

- 1) Turn the large **FMS** Knob to select the Map Page Group.
- 2) Turn the small **FMS** Knob to select the Traffic Map Page.
- 3) Press the **OPERATE** Softkey to begin displaying traffic. 'OPERATING' is displayed in the Traffic mode field.
- 4) Press the **ALT MODE** Softkey to change the altitude volume.
- 5) Press the **STANDBY** Softkey to place the system in the Standby mode. 'STANDBY' is displayed in the Traffic mode field.
- 6) Turn the **Joystick** clockwise to display a larger area or counter-clockwise to display a smaller area.



Figure 6-187 Traffic Map Page

The Traffic Map Page shows surrounding TAS traffic data in relation to the aircraft's current position and altitude, without basemap clutter. Aircraft orientation is always heading up unless there is no valid heading. Map range is adjustable with the **Joystick** from 2 to 12 nm, as indicated by the map range rings.

The traffic mode and altitude display mode are annunciated in the upper left corner.

Displaying traffic information (maps other than the Traffic Map Page):

- 1) Press the **MAP** Softkey.
- 2) Press the **TRAFFIC** Softkey. Traffic is now displayed on the map.

When traffic is selected on maps other than the Traffic Map Page, a traffic icon is shown to indicate TAS is enabled for display.

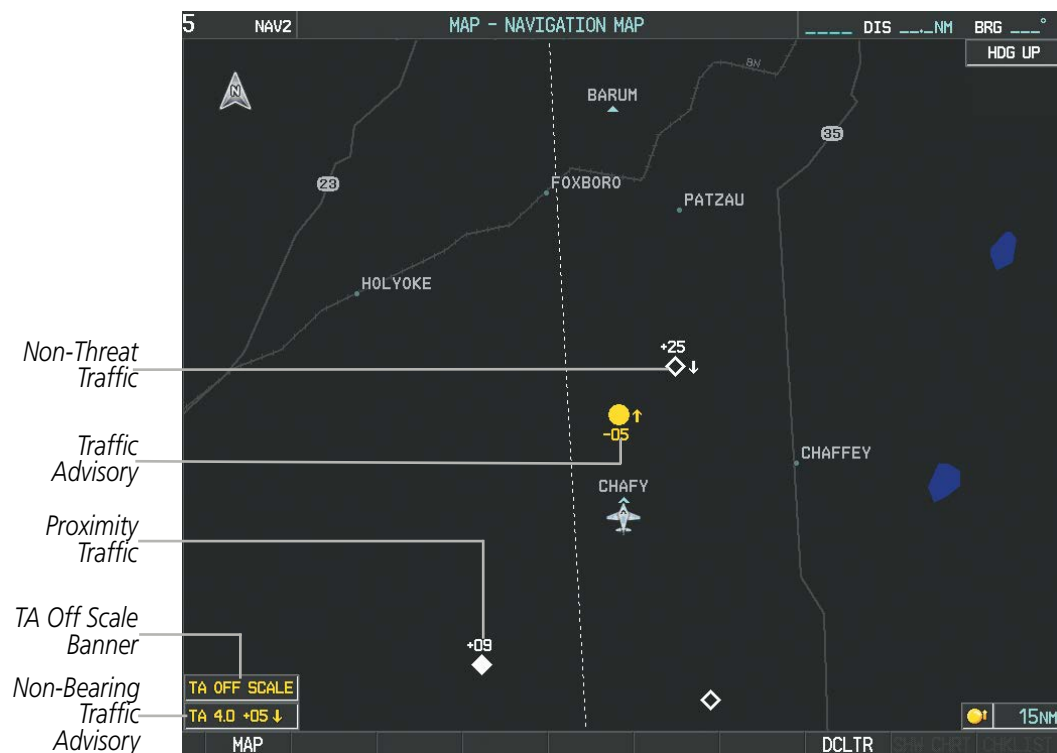

Figure 6-188 TAS Traffic on Navigation Map

Displaying traffic information (PFD Inset Map):

- 1) Press the **INSET** Softkey.
- 2) Press the **TRAFFIC** Softkey to display traffic data on the inset map (TRFC-1).
- 3) Press the softkey again to display the traffic-only inset (TRFC-2).
- 4) Press the softkey again to remove traffic data.

The Navigation Map Page Setup Menu also controls the display of traffic. The setup menu controls the map range settings. Traffic data symbols and labels can be decluttered from the display. If a map range larger than the map range setting is selected, the data is removed from the map. Maps besides the Traffic Map Page use settings based on those selected for the Navigation Map Page.

ALTITUDE DISPLAY

Changing the altitude display mode:

- 1) On the Traffic Page, select the **ALT MODE** Softkey.
 - 2) Press one of the following Softkeys:
 - **BELOW**
 - **NORMAL**
 - **ABOVE**
 - **UNREST** (unrestricted)
 - 3) To return to the Traffic Page, press the **BACK** Softkey.
- Or:**
- 1) Press the **MENU** Key.
 - 2) Turn the small **FMS** Knob to select one of the following:
 - **BELOW**
 - **NORMAL**
 - **ABOVE**
 - **UNREST** (unrestricted)
 - 3) Press the **ENT** Softkey.

TRAFFIC MAP PAGE DISPLAY RANGE

The display range on the Traffic Map Page can be changed at any time. Map range is adjustable with the **Joystick** from 2 to 12 nm, as indicated by the map range rings.

Changing the display range on the Traffic Page:

- 1) Turn the **Joystick**.
- 2) The following range options are available:
 - 2 nm
 - 2 and 6 nm
 - 6 and 12 nm

Customizing the traffic display on the Navigation Map Page:

- 1) Select the Navigation Map Page.
- 2) Press the **MENU** Key.
- 3) With Map Setup highlighted, press the **ENT** Key (Figure 6-189).
- 4) Turn the small **FMS** Knob to select the Traffic Group and press the **ENT** Key (Figure 6-190).
- 5) Turn the large **FMS** Knob or press the **ENT** Key to scroll through the selections (Figure 6-191).
 - TRAFFIC – Turns the display of traffic data on or off
 - TRAFFIC MODE – Selects the traffic mode for display; select from:
 - All Traffic - Displays all traffic
 - TA/PA - Displays Traffic Alerts and Proximity Advisories
 - TA ONLY - Displays Traffic Alerts only
 - TRAFFIC SMBL – Selects the maximum range at which traffic symbols are shown
 - TRAFFIC LBL – Selects the maximum range at which traffic labels are shown with the option to turn off
- 6) Turn the small **FMS** Knob to scroll through options (ON/OFF, range settings, etc.).
- 7) Press the **ENT** Key to select an option.
- 8) Push the **FMS** Knob or the **CLR** Key to return to the Navigation Map Page.



Figure 6-189 Navigation Map Page Menu

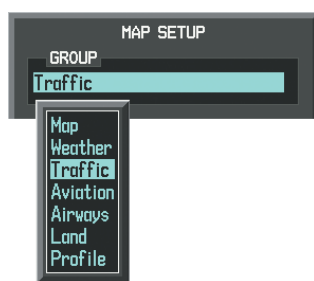

Figure 6-190 Navigation Map Page Setup Menu

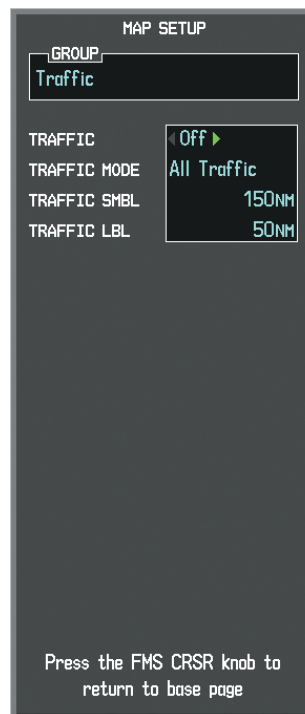

Figure 6-191 Navigation Map Page Setup Menu, Traffic Group

TAS ALERTS

NOTE: Refer to the SKY497 documentation for information on alerts generated by the TAS equipment.

When the number of TAs on the Traffic Map Page increases from one scan to the next, the following occur:

- A voice alert is generated.
- A TRAFFIC Annunciation appears at the top right of the airspeed on the PFD, flashing for 5 seconds and remaining displayed until no TAs are detected in the area.
- The PFD Inset Map is automatically displayed with TA traffic

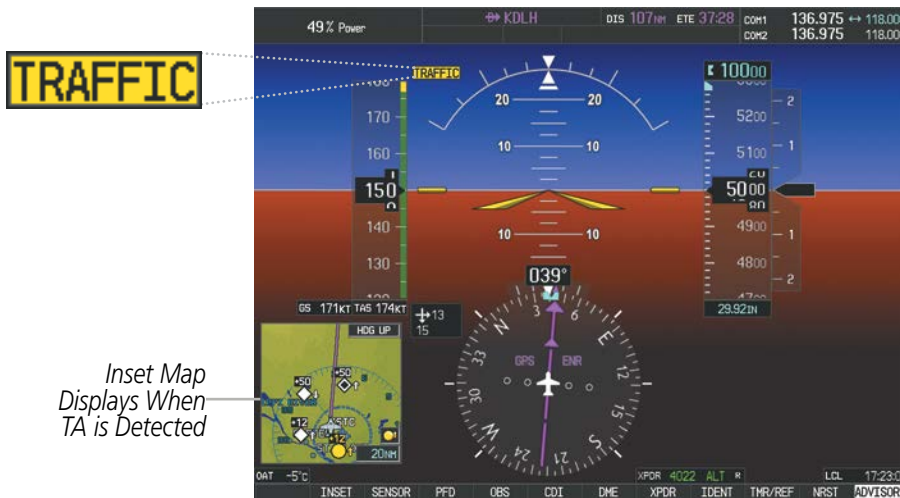

Figure 6-192 Traffic Annunciation (PFD)

SYSTEM STATUS

The traffic mode is annunciated in the upper left corner of the Traffic Map Page.

Mode	Traffic Mode Annunciation (Traffic Map Page)	Traffic Display Status Icon (Other Maps)
TAS System Test Initiated	TEST (also shown in white in center of page)	
TAS Operating	OPERATING	
TAS Standby	STANDBY (also shown in white in center of page)	
TAS Failed*	FAIL	

* See Table 6-40 for additional failure annunciations

Table 6-39 TAS Modes

If the unit fails, an annunciation as to the cause of the failure is shown in the center of the Traffic Map Page.

Traffic Map Page Annunciation	Description
NO DATA	Data is not being received from the TAS unit
DATA FAILED	Data is being received from the TAS unit, but the unit is self-reporting a failure
FAILED	Incorrect data format received from the TAS unit

Table 6-40 TAS Failure Annunciations

The annunciations to indicate the status of traffic information appear in a banner at the lower left corner of maps on which traffic can be displayed.

Traffic Status Banner Annunciation	Description
TA OFF SCALE	A Traffic Advisory is outside the selected display range* Annunciation is removed when traffic comes within the selected display range
TA X.X ± XX ↓	System cannot determine bearing of Traffic Advisory** Annunciation indicates distance in nm, altitude separation in hundreds of feet, and altitude trend arrow (climbing/descending)
TRFC FAIL	TAS unit has failed (unit is self-reporting a failure or sending incorrectly formatted data)
NO TRFC DATA	Data is not being received from the TAS unit

*Shown as symbol on Traffic Map Page

**Shown in center of Traffic Map Page

Table 6-41 TAS Traffic Status Annunciations

6.12 GARMIN GDL 88 ADS-B TRAFFIC



WARNING: Do not rely solely upon the display of traffic information for collision avoidance maneuvering. The traffic display does not provide collision avoidance resolution advisories and does not under any circumstances or conditions relieve the pilot's responsibility to see and avoid other aircraft.



WARNING: Do not rely solely upon the display of traffic information to accurately depict all of the traffic information within range of the aircraft. Due to lack of equipment, poor signal reception, and/or inaccurate information from other aircraft, traffic may be present but not represented on the display.



NOTE: The nose of the 'own ship' symbol represents the location of the aircraft. The center of any traffic symbol represents the location of that traffic. The traffic and own ship symbols are an abstract representation and do not reflect the physical extend of the aircraft/traffic, and should not replace other methods for identifying traffic.

The optional Garmin GDL 88 is a dual-link Universal Access Transceiver (UAT). It sends and receives Automatic Dependent Surveillance-Broadcast (ADS-B) traffic information on the 978 MHz UAT frequency. It also receives data link weather information on the UAT frequency. As a dual-link transceiver, the GDL 88 also receives ADS-B traffic information with its 1090 MHz Extended Squitter (1090 ES) receiver. The system provides visual annunciations and voice traffic alerts to help the pilot visually acquire potentially conflicting traffic. This discussion covers the traffic features of the GDL 88; refer to the Flight Information Service-Broadcast (FIS-B) Weather discussion for more information about the UAT data link weather features of the GDL 88.

ADS-B SYSTEM OVERVIEW

ADS-B is a core technology in the FAA NextGen air traffic control system and is comprised of three segments: ADS-B (Broadcast), ADS-R (Rebroadcast), and Traffic Information Service-Broadcast (TIS-B).

ADS-B is the automatic broadcast of position reports by aircraft, surface vehicles, and transmitters on fixed objects. These broadcasts contain information such as GPS position, identity (Flight ID, Call Sign, Tail Number, ICAO registration number, etc.), ground track, ground speed, pressure altitude, and emergency status.

- SYSTEM OVERVIEW
- FLIGHT INSTRUMENTS
- EIS
- AUDIO PANEL & CNS
- FLIGHT MANAGEMENT
- HAZARD AVOIDANCE
- AFCS
- ADDITIONAL FEATURES
- APPENDICES
- INDEX

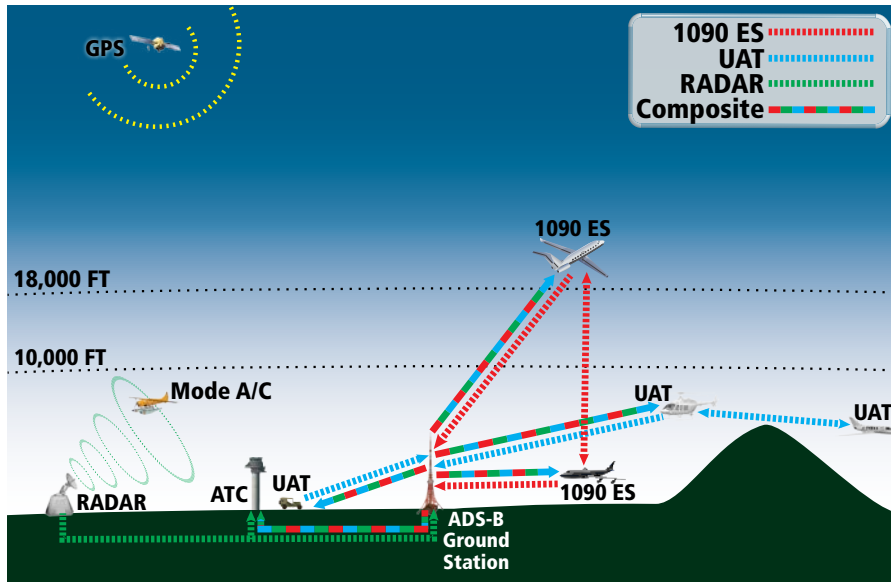

Figure 6-193 ADS-B System

For the purpose of distinguishing between levels of ADS-B service, there are three classifications of aircraft or system capability: ADS-B In, ADS-B Out, and ADS-B participating. ADS-B In refers to the capability to receive ADS-B information. ADS-B Out refers to the capability to transmit ADS-B information. ADS-B participating refers to the capability to both send and receive ADS-B information. Aircraft lacking either ADS-In, ADS-B Out, or both ADS-B capabilities may also be referred to as ADS-B nonparticipating aircraft.

AUTOMATIC DEPENDENT SURVEILLANCE-REBROADCAST (ADS-R)

Because it is not required that ADS-B In capable aircraft be able to receive ADS-B data on both the 1090 MHz and 978 MHz data links, a method exists to get data from one data link to the other. ADS-R is the rebroadcast of ADS-B data by FAA ground stations, which provide this service by taking data from one link and rebroadcasting it on the other link. For example, two aircraft are in the service volume for a ground station, and one is transmitting on 1090 MHz and the other on 978 MHz, the ground station retransmits the data from each aircraft on the other link to ensure the two aircraft can “see” each other.

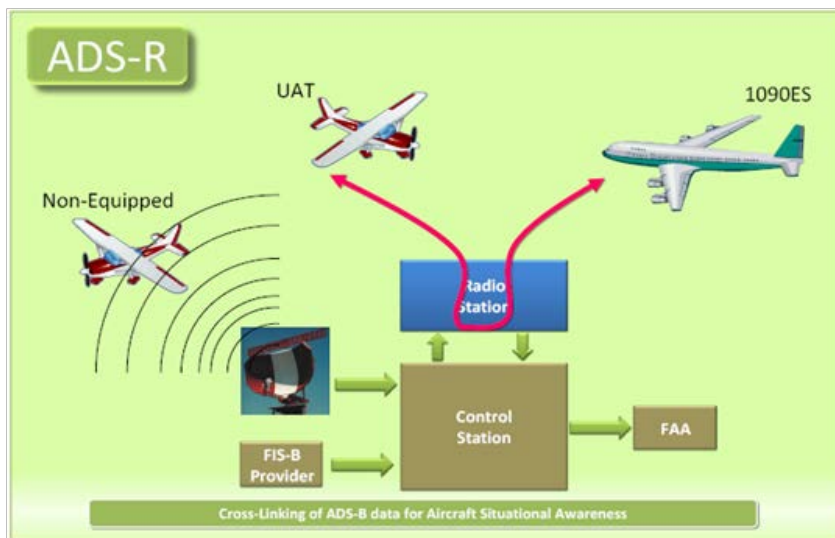

Figure 6-194 ADS-R Operation - FAA Illustration

The GDL 88 is capable of receiving ADS-B traffic reports directly on the 1090 MHz ES data link in addition to the 978 MHz UAT data link. This allows the GDL 88 to receive ADS-B position reports on both frequencies from aircraft in the vicinity, without relying on ADS-R ground station coverage.

TRAFFIC INFORMATION SERVICE-BROADCAST (TIS-B)

TIS-B provides the bridge between the radar-based ATC system and the ADS-B-based system. When an ADS-B In or Out capable aircraft is within the service volume of an FAA ADS-B ground station, the ground station broadcasts a portion of the ATC radar data to the aircraft. This aircraft is then included in the list of aircraft being provided TIS-B service and is then considered a “TIS-B participant.”

TIS-B coverage is available when the aircraft is within ground station coverage, in Secondary Surveillance Radar coverage, and the other aircraft is also in Secondary Surveillance Radar coverage, and is transmitting its altitude.

The ground station provides ATC radar information for other aircraft within ±3,500 feet and 15 NM of the participant, to include altitude, position, ground speed, and ground track. TIS-B broadcasts occur once every three to thirteen seconds, depending on the characteristics of the ground station providing the TIS-B service.

The following table describes the aircraft that are observed by a GDL 88-equipped aircraft according to the level of equipment installed in the other aircraft.

Other Aircraft Equipment	Viewable by GDL 88 UAT Equipped Aircraft
1090ES Out Equipped	Yes
UAT Receive Only Capable	No
UAT Transmit Equipped	Yes
No Transponder, No ADS-B	No
Non ADS-B Equipped, but with Mode C or S Transponder	Yes*

* Only when in ADS-B ground station coverage and when the other aircraft is in ATC radar coverage.

Table 6-42 Aircraft Available for Viewing by an ADS-B Equipped Own Aircraft

ADS-B WITH TAS

When an optional Traffic Advisory System (TAS) is also installed and operating with the UAT, the UAT receives traffic from the active traffic system and attempts to match (or “correlate”) this traffic with ADS-B traffic the UAT is tracking. When a correlation is made, only the traffic with the most accurate information is displayed to the flight crew. Any traffic that is not correlated (i.e., only detected by one system but not the other) is also displayed for the flight crew. This correlation of traffic by the UAT improves the accuracy of the traffic displayed, while reducing the occurrence of the same aircraft being displayed twice.



NOTE: When operating on the edges of ATC radar coverage or when using an optional active traffic system providing intermittent traffic data, a single aircraft may be briefly or periodically depicted as two aircraft on the display.

Either the TAS or the UAT can issue a traffic alert. If both systems determine an alert is necessary, and the traffic is correlated, only the TAS-generated alert is issued. If traffic is not correlated, and both systems determine an alert is necessary, the TAS-generated alert occurs first, followed by the UAT-generated alert.

CONFLICT SITUATIONAL AWARENESS & ALERTING

Conflict Situational Awareness (CSA) is an alerting algorithm which provides ADS-B traffic alerting similar to the TAS systems discussed previously.

The UAT issues a voice alert when a Traffic Advisory (TA) is displayed, for example “Traffic! Two O’clock, Low, Two Miles.”

The own aircraft altitude above terrain determines the sensitivity of the CSA algorithm to minimize nuisance alerts. Radar Altitude (if available), Height Above Terrain, and Geodetic Sea Level (GSL) altitude are used to adjust the sensitivity of the CSA algorithm in accordance with the following table:

Sensitivity Level	Radar Altitude (Feet)	Height Above Terrain (HAT)	GPS Phase of Flight	Own Altitude (Feet)	Look-ahead time (sec)	Vertical Threshold for Alert (feet)	Protected Volume (NM)
4	Up to 1000 (RA or HAT)	Any	Any	Any	20	850	0.20
4	Unavailable	Any	Any	Any	20	850	0.20
4	Unavailable	Unavailable	Approach	Any	20	850	0.20
5	>1000 <=2350	Any	Any	Any	25	850	0.20
5	Unavailable	>1000 <=2350	Any	Any	25	850	0.20
5	Unavailable	Unavailable	Terminal	Any	25	850	0.20
6	Unavailable or >2350	Unavailable or >2350	Not approach and not Terminal (including unavailable)	<=5000	30	850	0.35
7	Unavailable or >2350	Unavailable or >2350	Not approach and not Terminal (including unavailable)	>5000 <=10,000	40	850	0.55
8	Unavailable or >2350	Unavailable or >2350	Not approach and not Terminal (including unavailable)	>10,000 <=20,000	45	850	0.80
9	Unavailable or >2350	Unavailable or >2350	Not approach and not Terminal (including unavailable)	>20,000 <=42,000	48	850	1.10
10	Unavailable or >2350	Unavailable or >2350	Not approach and not Terminal (including unavailable)	> 42,000	48	1200	1.10

Table 6-43 CSA Alerting Thresholds for ADS-B Traffic

When the system detects a new Traffic Advisory (TA), the following occur:

- The system issues a single **“Traffic!”** voice alert, followed by additional voice information about the bearing, relative altitude, and approximate distance from the intruder that triggered the TA (Table 6-44). For example, the announcement **“Traffic! 12 o’clock, high, four miles,”** would indicate the traffic is in front of own aircraft, above own altitude, and approximately four nautical miles away.
- A ‘TRAFFIC’ annunciation appears at the top right of the airspeed on the PFD, flashes for five seconds, and remains displayed until no TAs are detected in the area (Figure 6-195).
- The PFD Inset Map is automatically displayed with TA traffic.

If the bearing of TA traffic cannot be determined, an amber text banner will be displayed in the center of the Traffic Map Page and in the lower-left of the PFD inset map instead of a TA symbol. The text will indicate ‘TA’ followed by the distance, relative altitude, and vertical trend arrow for the TA traffic, if known.

A TA will be displayed for at least eight seconds, even if the condition(s) that initially triggered the TA are no longer a factor.

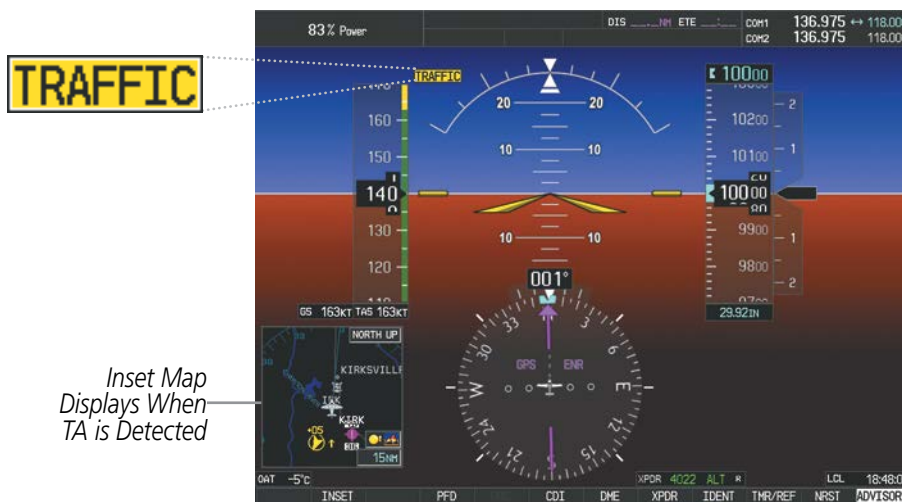

Figure 6-195 Traffic Annunciation (PFD)

Bearing	Relative Altitude	Approximate Distance (nm)
“One o’clock” through “Twelve o’clock” or “No Bearing”	“High”, “Low”, “Same Altitude” (if within 200 feet of own altitude), or “Altitude not available”	“Zero miles”, “Less than one mile”, “One Mile” through “Ten Miles”, or “More than ten miles”

Table 6-44 TA Descriptive Voice Announcements



NOTE: ADS-B traffic voice alerts are suppressed when below 500 feet.

AIRBORNE AND SURFACE APPLICATIONS

The UAT can help the pilot visually acquire traffic both in the air and on-the-ground. There are two ADS-B applications or modes: Airborne Situational Awareness (AIRB) and Surface Situational Awareness (SURF). The system automatically selects the appropriate application based on conditions.

The AIRB application is on when the aircraft is more than five NM and 1,500 feet above the nearest airport. When the AIRB application is active, the system only displays traffic which is airborne.

The SURF application is on when the aircraft is within five NM and less than 1,500 feet above field elevation. When the SURF application is on, the system displays airborne and on the ground traffic. At a Traffic Map Page range of two nm or less, the airport environment (including taxiways and runways) appears in addition to traffic. The airport displays are derived from the SafeTaxi database. Refer to the Additional Features section for more information about SafeTaxi displays.

NOTE: Do not rely on the solely on the traffic display to determine the runway alignment of traffic, especially when runways are in close proximity to each other.

Due to the varying precision of the data received via ADS-B, ADS-R, and TIS-B, all traffic targets may not be depicted on the traffic display. Because higher data precision is required for display in the SURF environment, some traffic eligible for AIRB will not be displayed while SURF is on. Individual eligibility for AIRB and SURF is depicted on the AUX-ADS-B Status Page, discussed later in this section.

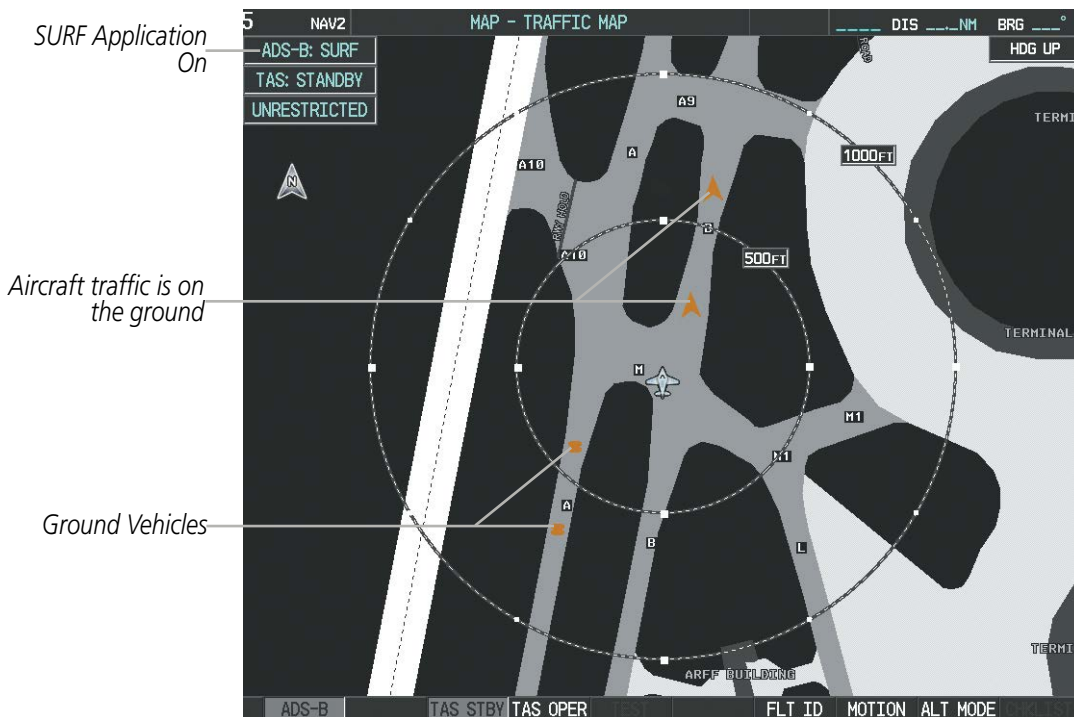

Figure 6-196 Traffic Map Page with SURF Mode On

TRAFFIC DESCRIPTION

The symbols used to display ADS-B traffic are shown in Table 6-45. Above or below the traffic symbol is the traffic identifier, and altitude. A small up or down arrow next to the traffic symbol indicates that the traffic is climbing or descending at a rate of at least 500 feet per minute.











Symbol	Description
	Traffic Advisory with directional information. Points in the direction of the intruder aircraft track.
	Traffic Advisory without directional information.
	Traffic Advisory out of the selected display range. Displayed at outer range ring at proper bearing.
	Proximity Advisory with directional information. Points in the direction of the aircraft track.
	Proximity Advisory without directional information.
	Non-threat traffic with directional information. Points in the direction of the intruder aircraft track.
	Non-threat traffic without directional information.
	Traffic located on the ground with directional information. Points in the direction of the aircraft track. Ground traffic is only displayed when ADS-B is in Surface (SURF) Mode or own aircraft is on the ground.
	Ground traffic without directional information. Ground traffic is only displayed when ADS-B is in Surface (SURF) Mode or own aircraft is on the ground.
	Non-aircraft ground traffic. Ground traffic is only displayed when ADS-B is in Surface (SURF) Mode or own aircraft is on the ground.

Table 6-45 ADS-B Traffic Symbology

OPERATION

TRAFFIC MAP PAGE

The Traffic Map Page shows surrounding traffic data in relation to the aircraft's current position and altitude, without basemap clutter. Aircraft orientation is always heading up unless there is no valid heading. Map range is adjustable with the **Joystick**, as indicated by the map range rings.

The traffic mode and altitude display mode are annunciated in the upper left corner of the page.



Figure 6-197 Traffic Map Page

Enabling/disabling the display of ADS-B traffic.

- 1) Select the Traffic Map Page.
 - 2) Press the **ADS-B** Softkey.
- Or:**
- a) Press the **MENU** Key and turn the small **FMS** Knob to highlight 'ADS-B On' or 'ADS-B Off'.
 - b) Press the **ENT** Key.

Testing the display of ADS-B traffic:

- 1) Select the Traffic Map Page.
 - 2) If necessary, turn the Joystick to select a map range of 2 and 6 nm to ensure full test pattern display.
 - 2) Ensure the **ADS-B** Softkey is disabled.
 - 3) If an optional TAS is installed, ensure the **TAS STBY** Softkey is enabled.
 - 4) Press the **Test** Softkey.
- Or:**
- a) Press the **MENU** Key.
 - b) Turn the small **FMS** Knob to highlight 'Test Mode'.
 - c) Press the **ENT** Key.

A test pattern of traffic symbols appears during the test, and a 'TRAFFIC' annunciation appears on the PFD. At the conclusion of the test, the system issues the voice alert "Traffic System Test". If the test pattern is displayed and the voice alert is heard, the system has passed the test.

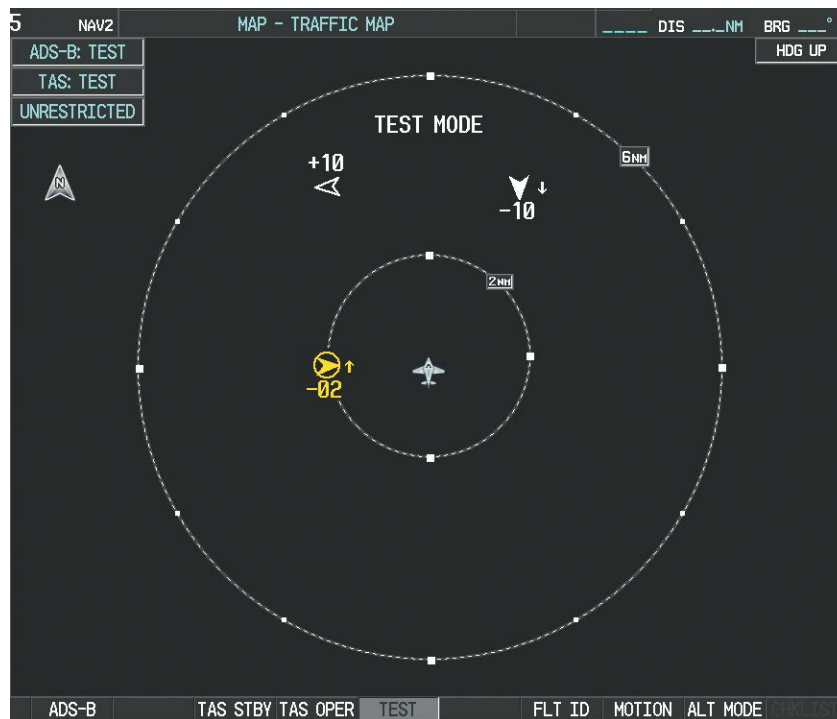

Figure 6-198 Traffic Map Page with Test Mode Enabled

The pilot can select the volume of airspace in which non-threat and proximity traffic is displayed. TAs occurring outside of these limits will always be shown.

Changing the altitude range:

- 1) On the Traffic Map Page, select the **ALT MODE** Softkey.
 - 2) Press one of the following Softkeys:
 - **ABOVE:** Displays non-threat and proximity traffic from 9000 feet above the aircraft to 2700 feet below the aircraft. Typically used during climb phase of flight.
 - **NORMAL:** Displays non-threat and proximity traffic from 2700 feet above the aircraft to 2700 feet below the aircraft. Typically used during enroute phase of flight.
 - **BELOW:** Displays non-threat and proximity traffic from 2700 feet above the aircraft to 9000 feet below the aircraft. Typically used during descent phase of flight.
 - **UNREST** (unrestricted): All traffic is displayed from 9900 feet above and 9900 feet below the aircraft.
 - 3) To return to the Traffic Map Page, press the **BACK** Softkey.
- Or:**
- 1) Press the **MENU** Key.
 - 2) Turn the small **FMS** Knob to select one of the following (see softkey description in step 2 above):

- ABOVE
- NORMAL
- BELOW
- UNRESTRICTED

3) Press the **ENT** Key.

DISPLAYING MOTION VECTORS

When Absolute Motion Vectors are selected, the vectors extending from the traffic symbols depict the traffic's reported track and speed over the ground. When Relative Motion Vectors are selected, the vectors extending from the traffic symbols display how the traffic is moving relative to own aircraft. These vectors are calculated using the traffic's track and ground speed and own aircraft's track and ground speed. These two values are combined to depict where the traffic is moving purely with respect to own aircraft, and provide a forecast of where the traffic will be, relative to own aircraft, in the near future.

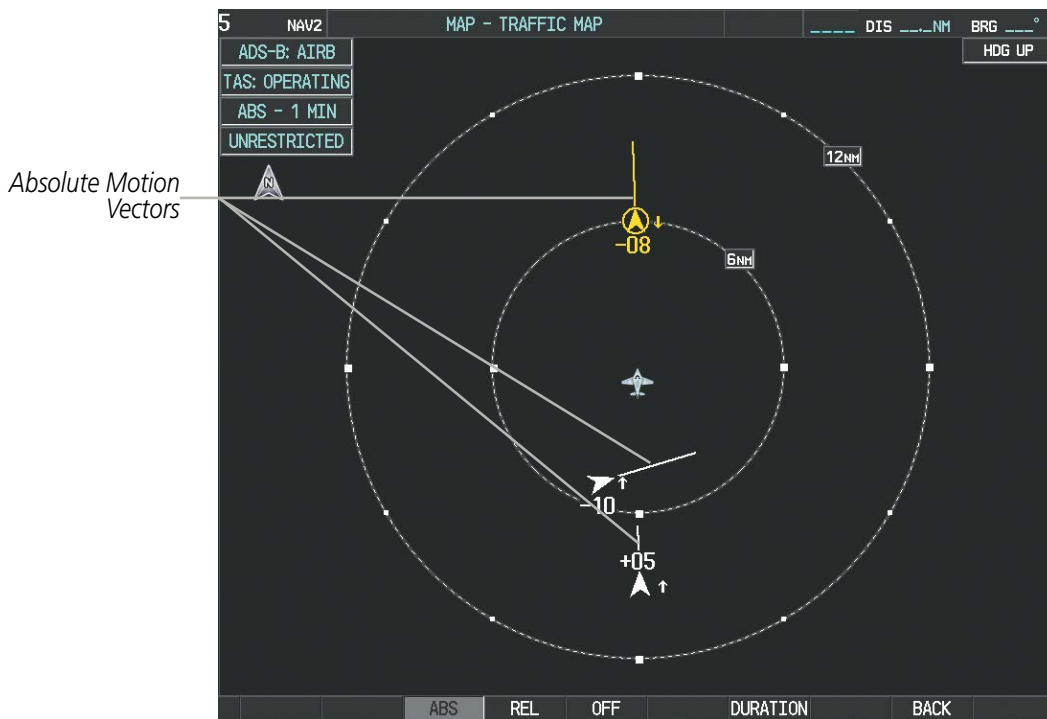

Figure 6-199 Traffic Map Page with Absolute Motion Vectors Enabled

Enabling/disabling the Motion Vector display:

- 1) Select the Traffic Map Page.
 - 2) Press the **MOTION** Softkey.
 - 3) Press one of the following softkeys:
 - **ABS**: Displays the motion vector pointing in the absolute direction.
 - **REL**: Displays the motion vector relative to own aircraft
 - **OFF**: Disables the display of the motion vector.
- Or:**
- 1) Select the Traffic Map Page.
 - 2) Press the **MENU** Key.
 - 3) Turn the small **FMS** Knob to highlight 'Relative Motion', 'Absolute Motion' or 'Motion Vector Off'.
 - 4) Press the **ENT** Key.

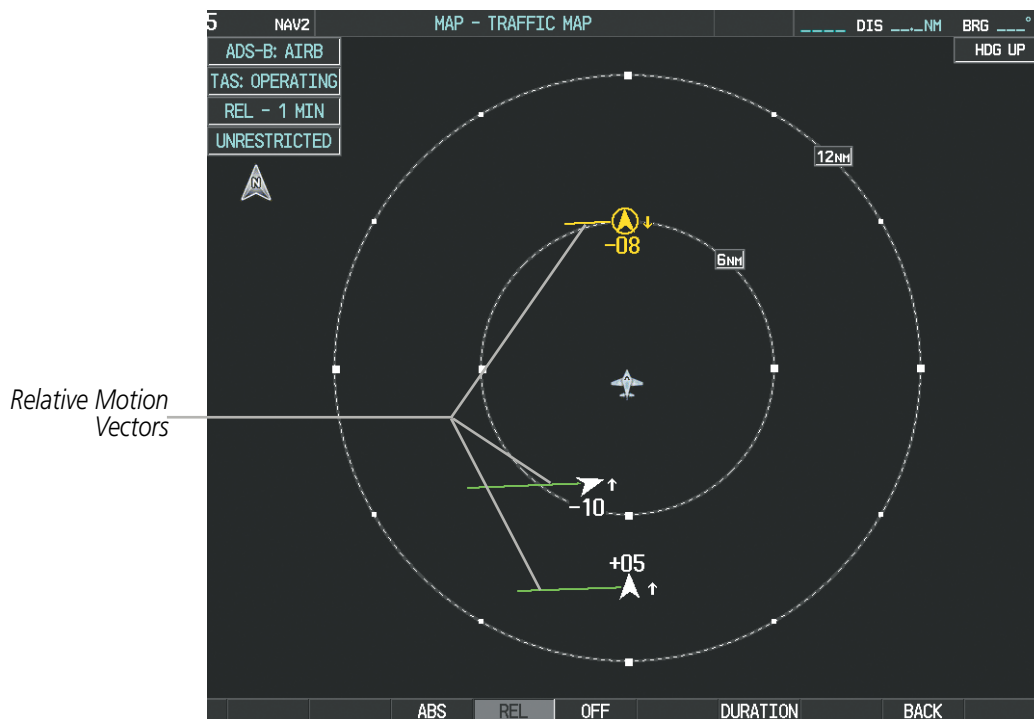

Figure 6-200 Traffic Map Page with Relative Motion Vectors Enabled

Adjusting the duration for the Motion Vector projected time:

- 1) Select the Traffic Map Page.
- 2) Press the **MOTION** Softkey.
- 3) Press the **DURATION** Softkey.
- 4) Press a softkey for the desired duration (**30 SEC, 1 MIN, 2 MIN, 5 MIN**).
- 5) When finished, press the **BACK** Softkey to return to the Traffic Map Page.

FLIGHT ID DISPLAY

The Flight IDs of other aircraft (when available) can be enabled for display on the Traffic Map Page (Figure 6-201). When a flight ID is received, it will appear above or below the corresponding traffic symbol on the Traffic Map Page when this option is enabled.

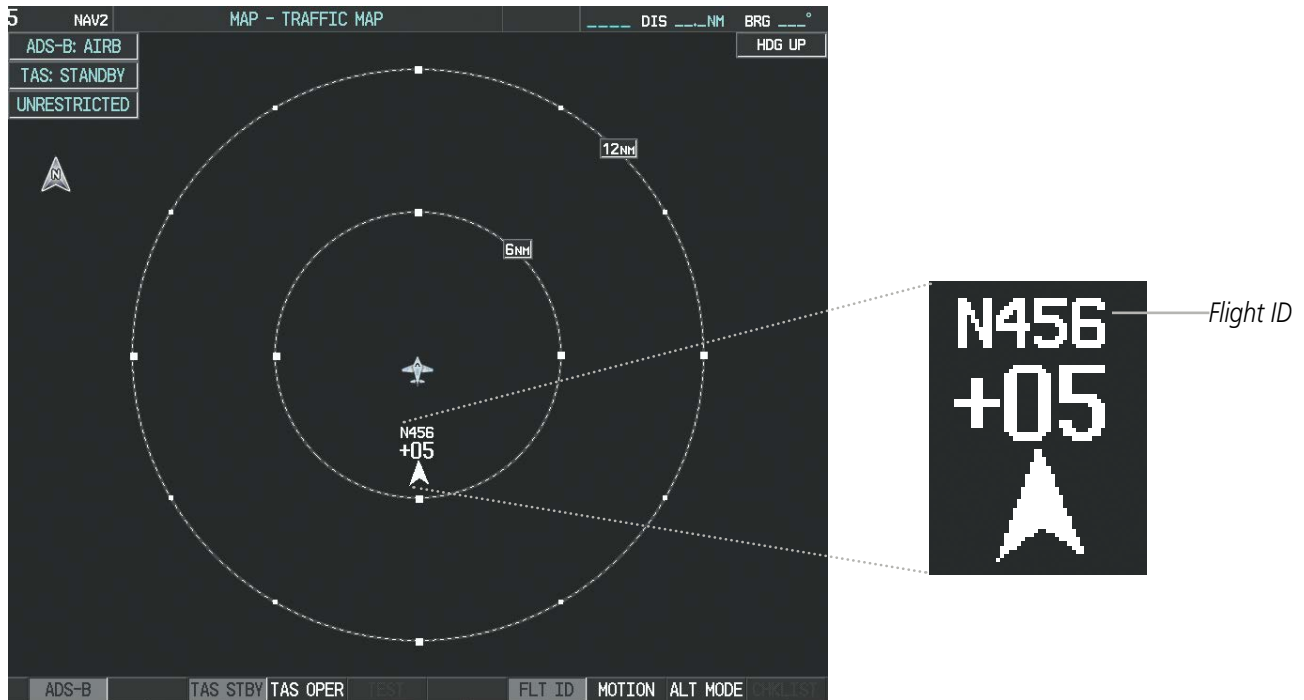

Figure 6-201 Traffic Map Page with Flight IDs Enabled

Enabling/Disabling Flight ID Display:

On the Traffic Map Page, press the **FLT ID** Softkey.

DISPLAYING ADDITIONAL TRAFFIC INFORMATION

The Traffic Map Page can display additional information for a selected aircraft symbol. This may include the aircraft tail number/Flight ID, type of aircraft (e.g., glider, small/medium/large aircraft, service vehicle, unmanned airborne vehicle (UAV)), course, track, groundspeed), and other information.

Showing additional traffic information:

- 1) Select the Traffic Map Page.
- 2) Push the **FMS** Knob. A cyan bracket highlights the first selected traffic symbol. Additional information appears in a window in the upper-right corner of the Traffic Map Page.
- 3) To select a different aircraft symbol, turn the **FMS** Knob to move the cyan bracket until the selected aircraft traffic symbol is highlighted.
- 4) When finished, push the **FMS** Knob again to remove the cyan selection bracket.

TRAFFIC MAP PAGE DISPLAY RANGE

The display range on the Traffic Map Page can be changed at any time. Map range is adjustable with the **Joystick**, as indicated by the map range rings.

Changing the display range on the Traffic Map Page:

Turn the **Joystick** clockwise to increase the range of the traffic map, or counter-clockwise to decrease the range.

ADDITIONAL TRAFFIC DISPLAYS

The Map - Traffic Map Page is the principal map page for viewing traffic information. Traffic information can also be displayed on the following other maps for additional reference on the MFD when the traffic unit is operating:

- Navigation Map Page
- Nearest Pages
- Trip Planning Page
- Active Flight Plan Page

Traffic information can also be displayed on the PFD when the Synthetic Vision Technology (SVT) option is installed and enabled. See the Additional Features Section for details.

Displaying traffic information (MFD maps other than the Traffic Map Page):

- 1) Press the **MAP** Softkey.
- 2) Press the **TRAFFIC** Softkey. Traffic is now displayed on the map.

When traffic is selected on maps other than the Traffic Map Page, a traffic icon is shown to indicate traffic is enabled for display (Figure 6-202).

Displaying traffic on the Navigation Map

- 1) Ensure the traffic system is operating. With the Navigation Map displayed, press the **MAP** Softkey.
- 2) Press the **TRAFFIC** Softkey. Traffic is now displayed on the map as shown in Figure 6-202.

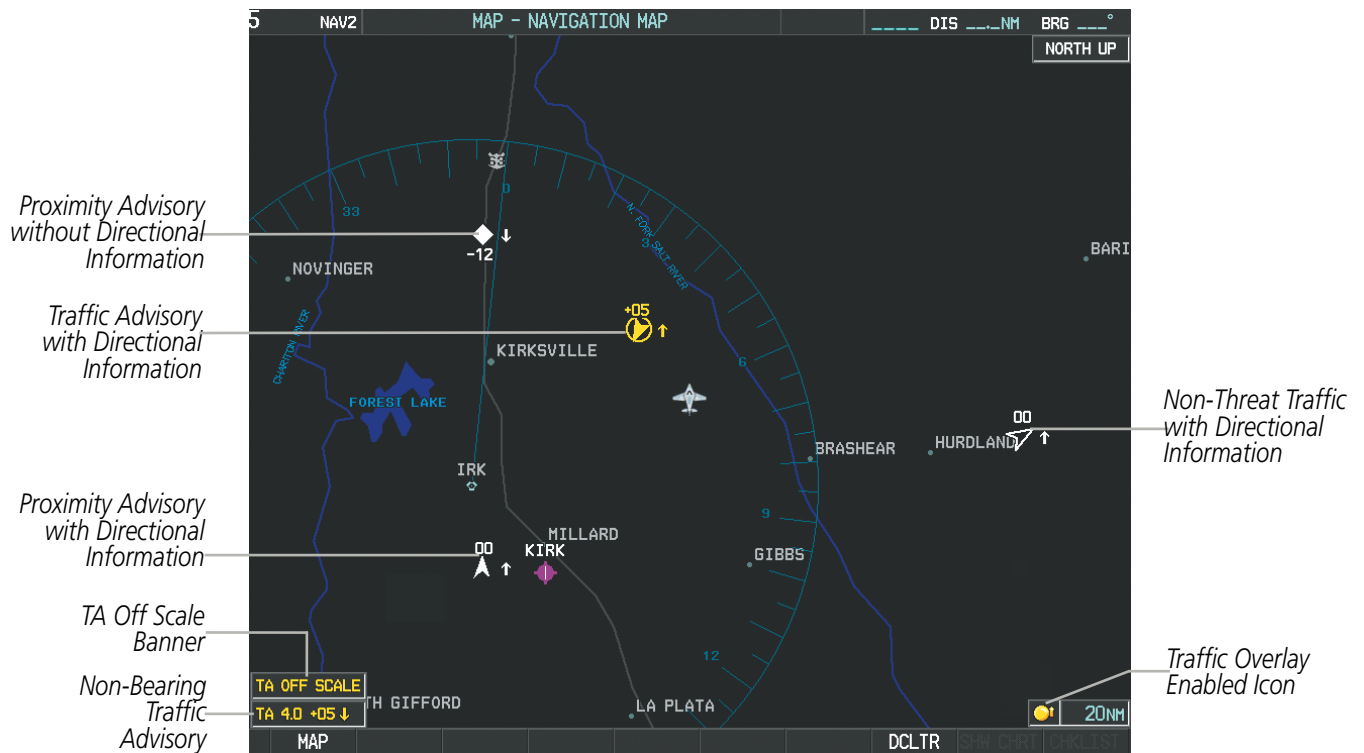

Figure 6-202 ADS-B Traffic on the Navigation Map Page

Customizing the traffic display on the Navigation Map Page:

- 1) Select the Navigation Map Page.
- 2) Press the **MENU** Key.
- 3) With Map Setup highlighted, press the **ENT** Key (Figure 6-203).
- 4) Turn the small **FMS** Knob to select the Traffic Group and press the **ENT** Key (Figure 6-204).
- 5) Turn the large **FMS** Knob or press the **ENT** Key to scroll through the selections (Figure 6-205).
 - TRAFFIC – Turns the display of traffic data on or off
 - TRAFFIC MODE – Selects the traffic mode for display; select from:
 - All Traffic - Displays all traffic
 - TA/PA - Displays Traffic Advisories and Proximity Advisories
 - TA ONLY - Displays Traffic Advisories only
 - TRAFFIC SMBL – Selects the maximum range at which traffic symbols are shown
 - TRAFFIC LBL – Selects the maximum range at which traffic labels are shown with the option to turn off
- 6) Turn the small **FMS** Knob to scroll through options (ON/OFF, range settings, etc.).
- 7) Press the **ENT** Key to select an option.
- 8) Push the **FMS** Knob or **CLR** Key to return to the Navigation Map Page.



Figure 6-203 Navigation Map Page Menu

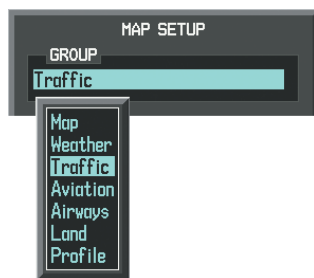

Figure 6-204 Navigation Map Page Setup Menu

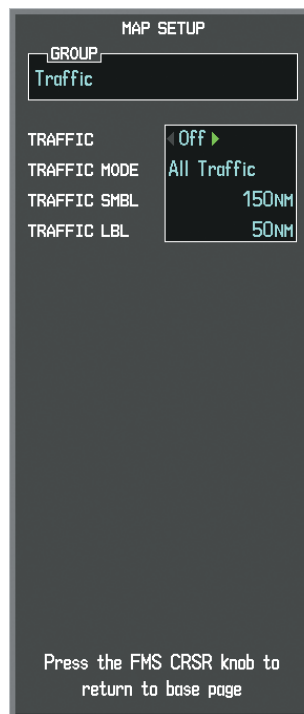

Figure 6-205 Navigation Map Page Setup Menu, Traffic Group

The Navigation Map Page Setup Menu also controls the display of traffic. The setup menu controls the map range settings. Traffic data symbols and labels can be decluttered from the display. If a map range larger than the map range setting is selected, the data is removed from the map. Maps besides the Traffic Map Page use settings based on those selected for the Navigation Map Page.

Traffic information can also be displayed on the PFD Inset Map by pressing the **INSET** Softkey. A traffic map will appear in heading up orientation. Traffic information can also be overlaid with navigation, topographic and optional data link weather information.

Displaying traffic information (PFD Inset Map):

- 1) Press the **INSET** Softkey.
- 2) Press the **TRAFFIC** Softkey to display traffic data on the inset map (TRFC-1).
- 3) Press the softkey again to display the traffic-only inset (TRFC-2).
- 4) Press the softkey again to remove traffic data.

SYSTEM STATUS

The traffic mode is annunciated in the upper left corner of the Traffic Map Page.

Mode	Traffic Mode Annunciation (Traffic Map Page)	Traffic Map Page Center Banner Annunciation	Traffic Display Status Icon (Other Maps)
ADS-B System Test Initiated	ADS-B: TEST	TEST MODE	
ADS-B Operating in Airborne Mode	ADS-B: AIRB	ADS-B: AIRB	
ADS-B Operating in Surface Mode	ADS-B: SURF	ADS-B: SURF	
ADS-B Traffic Off	ADS-B: OFF	ADS-B TRFC OFF	
ADS-B Traffic Not Available	ADS-B: N/A	ADS-B TRFC N/A	
ADS-B Failed*	ADS-B: FAIL	ADS-B TRFC FAIL	

* See Table 6-47 for additional failure annunciations

Table 6-46 Traffic Modes

If the traffic unit fails, an annunciation as to the cause of the failure is shown in the center of the Traffic Map Page. During a failure condition, the Operating Mode cannot be selected.

Traffic Map Page Center Annunciation	Description
NO DATA	Data is not being received from the traffic unit
DATA FAILED	Data is being received from the traffic unit, but the unit is self-reporting a failure
ADS-B TRFC FAIL	Incorrect data format received from the traffic unit

Table 6-47 Traffic Failure Annunciations

The annunciations to indicate the status of traffic information appear in a banner at the lower left corner of maps on which traffic can be displayed.

Traffic Status Banner Annunciation	Description
TA OFF SCALE	A Traffic Advisory is outside the selected display range*. Annunciation is removed when traffic comes within the selected display range.
TA X.X ± XX ↓	System cannot determine bearing of Traffic Advisory**. Annunciation indicates distance in nm, altitude separation in hundreds of feet, and altitude trend arrow (climbing/ descending).
TRFC FAIL	Traffic unit has failed (unit is self-reporting a failure or sending incorrectly formatted data)
NO TRFC DATA	Data is not being received from the traffic unit

*Shown as symbol on Traffic Map Page
 **Shown in center of Traffic Map Page

Table 6-48 Traffic Status Annunciations

Additional information about the status of ADS-B traffic products is available on the AUX - ADS-B Status Page.

Viewing ADS-B Traffic Status:

- 1) Turn the large **FMS** Knob to select the AUX Page Group.
- 2) Turn the small **FMS** Knob to select the AUX - ADS-B Status Page.

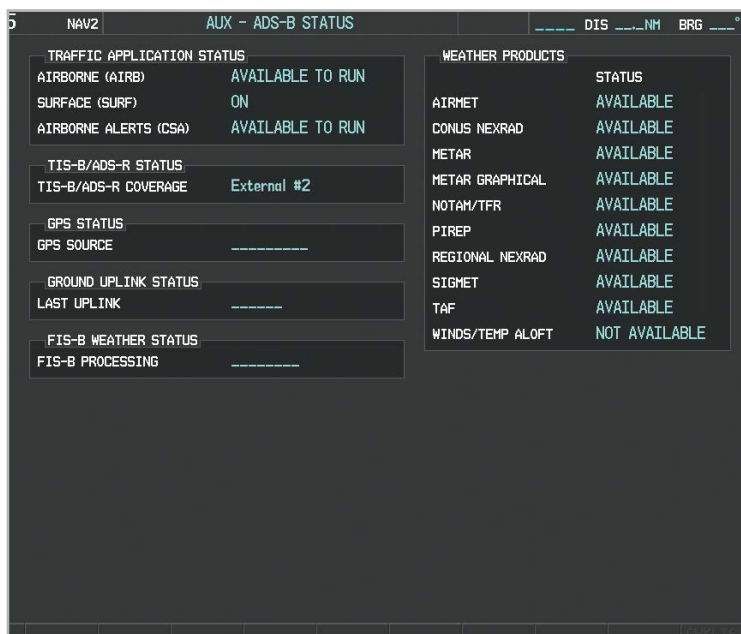

Figure 6-206 ADS-B Traffic Status on ADS-B Status Page

ADS-B Status Page Item	Status Message	Description
Traffic Application Status: AIRBORNE (AIRB), SURFACE (SURF), AIRBORNE ALERTS (CSA)	ON	Traffic application is currently on. Required input data is available, and it meets performance requirements.
	AVAILABLE TO RUN	Traffic application is not currently active, but application is ready to run when condition(s) determine the application should be active. Required input data is available, and it meets performance requirements.
	NOT AVAILABLE	Traffic application is not available. Required input data is available, but it does not meet performance requirements.
	FAULT	Traffic application is not available. Required input data is not available or the application has failed.
	NOT CONFIGURED	Traffic application is not available, because it has not been configured. If this annunciation persists, the system should be serviced.
	-----	Traffic application status is invalid or unknown.
TIS-B/ADS-R Coverage	AVAILABLE	The system is receiving the ADS-R coverage from an FAA ground station.
	NOT AVAILABLE	The system is not receiving the ADS-R coverage from an FAA ground station.
	-----	ADS-R coverage is invalid or unknown.
GPS Status: GPS Source	External #1	The GDL 88 is using the #1 GPS receiver for the GPS position source.
	External #2	The GDL 88 is using the #2 GPS receiver for the GPS position source.
	-----	The GPS source is invalid or unknown.
Ground Uplink Status: Last uplink	Number of minutes, or '-----'	Displays the number of minutes since the last uplink from a ground station occurred. If no uplink has been received, or the status is invalid, dashes appear instead of a number of minutes.

Table 6-49 AUX-ADS-B Status Page Messages for ADS-B Traffic

SYSTEM
OVERVIEW

FLIGHT
INSTRUMENTS

EIS

AUDIO PANEL
& CNS

FLIGHT
MANAGEMENT

**HAZARD
AVOIDANCE**

AFCS

ADDITIONAL
FEATURES

APPENDICES

INDEX

BLANK PAGE

SECTION 7 AUTOMATIC FLIGHT CONTROL SYSTEM



NOTE: *The approved pertinent flight manual always supersedes this Pilot's Guide.*

7.1 GARMIN AFCS

The digital Garmin Automatic Flight Control System (AFCS) is fully integrated within the Perspective® System avionics architecture. The System Overview section provides a block diagram to support this system description.

The AFCS can be divided into these main operating functions:

- **Flight Director (FD)** — Flight director operation takes place within either GIA 63W. Flight director commands are displayed on the PFD. The flight director provides:
 - Command Bars showing pitch/roll guidance
 - Vertical/lateral mode selection and processing
 - Autopilot communication
- **Autopilot (AP)** — Autopilot operation occurs within the pitch, roll, yaw, and pitch trim servos. It also provides servo monitoring and automatic flight control in response to flight director steering commands, Attitude and Heading Reference System (AHRS) attitude and rate information, and airspeed.
- **Yaw Damper (YD)** — The yaw servo (*optional*) is self-monitoring and provides Dutch roll damping and turn coordination in response to yaw rate, roll angle, lateral acceleration, and airspeed.
- **Manual Electric Trim (MET)** — The pitch trim adapter provides manual electric pitch trim capability when the autopilot is not engaged and provides directional trim during climbs and descents.

AFCS CONTROLS

The AFCS Control Unit is positioned below the GCU 478, and has the following controls:

- ① **HDG Key** Selects/deselects Heading Select Mode
- ② **NAV Key** Selects/deselects Navigation Mode
- ③ **AP Key** Engages/disengages the autopilot
- ④ **LVL Key** Engages the autopilot (if the autopilot is disengaged and the aircraft is within the autopilot engagement limitations) in level vertical and lateral modes
- ⑤ **NOSE UP/DN Wheel** Adjusts the vertical mode reference in Pitch Hold, Vertical Speed, Indicated Airspeed, and Altitude Hold modes
- ⑥ **IAS Key** Selects/deselects Indicated Airspeed Mode
- ⑦ **ALT Key** Selects/deselects Altitude Hold Mode
- ⑧ **VNV Key** Selects/deselects Vertical Path Tracking Mode for Vertical Navigation flight control
- ⑨ **VS Key** Selects/deselects Vertical Speed Mode
- ⑩ **YD Key** Engages/disengages the *optional* yaw damper
- ⑪ **FD Key** Activates/deactivates the flight director only
Pressing once turns on the director in the default vertical and lateral modes.
Pressing again deactivates the flight director and removes the Command Bars. If the autopilot is engaged, the key is disabled.
- ⑫ **APR Key** Selects/deselects Approach Mode

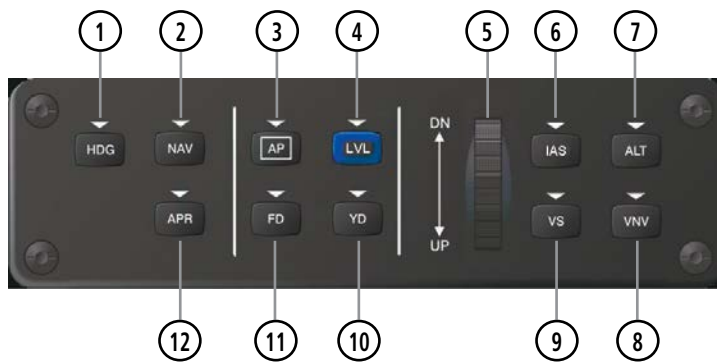

Figure 7-1 GMC 705 AFCS Control Unit

The following AFCS controls are located separately from the AFCS Control Unit:

- AP DISC Button (Autopilot Disconnect)** Disengages the autopilot, yaw damper, and interrupts pitch trim operation

An **AP DISC** Button is located on the pilot’s control stick.

This button may be used to acknowledge an autopilot disconnect alert and mute the associated aural tone.
- GA Button (Go Around)** Selects flight director Takeoff (on ground) or Go Around (in air) Mode

If an approach procedure is loaded, this switch also activates the missed approach when the selected navigation source is GPS or when the navigation source is VOR/LOC and a valid frequency has been tuned.

The **GA** Button is located on the power lever.
- MET Switch (Manual Electric Trim)** Used to command manual electric pitch trim

An **MET** Switch is located on the pilot and copilot control stick.

Press DN (forward) and UP (rearward) for manual electric trim.

FLIGHT DIRECTOR OPERATION

The flight director function provides pitch and roll commands to the AFCS and displays them on the PFD. With the flight director active, the aircraft can be hand-flown to follow the path shown by the Command Bars. Maximum commanded pitch (-15°, +20°) and roll (25°) angles, vertical acceleration, and roll rate are limited to values established during AFCS certification. The flight director also provides commands to the autopilot.

ACTIVATING THE FLIGHT DIRECTOR

An initial press of a key listed in Table 7-1 (when the flight director is not active) activates the flight director in the listed modes. The flight director may be turned off and the Command Bars removed from the display by pressing the **FD** Key again. The **FD** Key is disabled when the autopilot is engaged.

Control Pressed	Modes Selected			
	Lateral		Vertical	
FD Key	Roll Hold (default)	ROL	Pitch Hold (default)	PIT
AP Key	Roll Hold (default)	ROL	Pitch Hold (default)	PIT
GA Button	Takeoff (on ground) Go Around (in air)	TO GA	Takeoff (on ground) Go Around (in air)	TO GA
ALT Key	Roll Hold (default)	ROL	Altitude Hold	ALT
VS Key	Roll Hold (default)	ROL	Vertical Speed	VS
VNV Key	Roll Hold (default)	ROL	Vertical Path Tracking*	VPTH
NAV Key	Navigation**	GPS VOR LOC BC	Pitch Hold (default)	PIT
APR Key	Approach**	GPS VOR LOC	Pitch Hold (default)	PIT
HDG Key	Heading Select	HDG	Pitch Hold (default)	PIT
LVL Key	Level Hold	LVL	Level Hold	LVL

*Valid VNV flight plan must be entered before **VNV** Key press activates flight director.

The selected navigation receiver must have a valid VOR or LOC signal or active GPS course before **NAV or **APR** Key press activates flight director.

Table 7-1 Flight Director Activation

- SYSTEM OVERVIEW
- FLIGHT INSTRUMENTS
- EIS
- AUDIO PANEL & CNS
- FLIGHT MANAGEMENT
- HAZARD AVOIDANCE
- AFCS
- ADDITIONAL FEATURES
- APPENDICES
- INDEX

AFCS STATUS BOX

Flight director mode annunciations are displayed on the PFD when the flight director is active. Flight director selection and autopilot and yaw damper statuses are shown in the center of the AFCS Status Box. Lateral flight director modes are displayed on the left and vertical on the right. Armed modes are displayed in white and active in green.

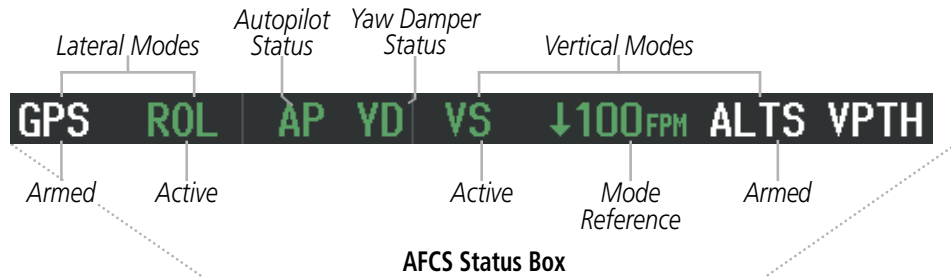

Figure 7-2 PFD AFCS Display

FLIGHT DIRECTOR MODES

Flight director modes are normally selected independently for the pitch and roll axes. Unless otherwise specified, all mode keys are alternate action (i.e., press on, press off). In the absence of specific mode selection, the flight director reverts to the default pitch and/or roll modes.

Armed modes are annunciated in white and active in green in the AFCS Status Box. Under normal operation, when the control for the active flight director mode is pressed, the flight director reverts to the default mode(s) for the axis(es). Automatic transition from armed to active mode is indicated by the white armed mode annunciation moving to the green active mode field and flashing for 10 seconds.

If the information required to compute a flight director mode becomes invalid or unavailable, the flight director automatically reverts to the default mode for that axis. A flashing yellow mode annunciation and annunciator light indicate loss of sensor (ADC) or navigation data (VOR, LOC, GPS, VNV, SBAS) required to compute commands. When such a loss occurs, the system automatically begins to roll the wings level (enters Roll Hold Mode) or maintain the pitch angle (enters Pitch Hold Mode), depending on the affected axis. The flashing annunciation stops when the affected mode key is pressed or another mode for the axis is selected. If after 10 seconds no action is taken, the flashing annunciation stops.



Figure 7-3 Loss of VOR Signal

The flight director is automatically disabled if the attitude information required to compute the default flight director modes becomes invalid or unavailable.

COMMAND BARS

Upon activation of the flight director, Command Bars are displayed in magenta on the PFD. If the aircraft is being flown by hand, the command bars are displayed hollow (Figure 7-4). The Command Bars do not override the Aircraft Symbol. The Command Bars move together vertically to indicate pitch commands and bank left or right to indicate roll commands.

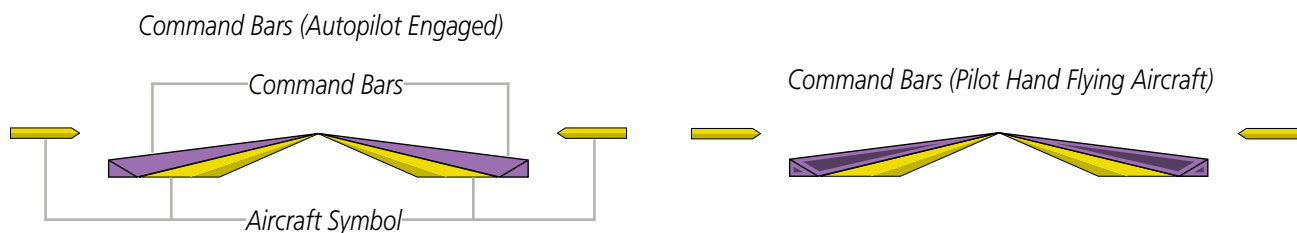

Figure 7-4 Command Bars

If the attitude information being sent to the flight director becomes invalid or unavailable, the Command Bars are removed from the display.

VERTICAL MODES

Table 7-2 lists the vertical modes with their corresponding controls and annunciations. The mode reference is displayed next to the active mode annunciation for Altitude Hold, Vertical Speed, and Indicated Airspeed modes. The **NOSE UP/DN** Wheel can be used to change the vertical mode reference while operating under Pitch Hold, Vertical Speed, Indicated Airspeed, or Altitude Hold modes. Increments of change and acceptable ranges of values for each of these references using the **NOSE UP/DN** Wheel are also listed in the table.

Vertical Mode	Description	Control	Annunciation	Reference Range	Reference Change Increment
Pitch Hold	Holds the current aircraft pitch attitude; may be used to climb/descend to the Selected Altitude	(default)	PIT	-15° to +20°	0.5°
Selected Altitude Capture	Captures the Selected Altitude	*	ALTS	± 150 ft	10 ft
Altitude Hold	Holds the current Altitude Reference	ALT Key	ALT nnnnn FT		
Vertical Speed	Maintains the current aircraft vertical speed; may be used to climb/descend to the Selected Altitude	VS Key	VS nnnn FPM	-3000 to +1500 fpm	100 fpm
Indicated Airspeed (IAS)	Maintains the current aircraft airspeed in IAS while the aircraft is climbing/descending to the Selected Altitude	IAS Key	IAS nnn KT	80 to 185 kt	1 kt
Vertical Path Tracking (If equipped)	Captures and tracks descent legs of an active vertical profile	VNV Key	VPTH		
VNV Target Altitude Capture	Captures the Vertical Navigation (VNV) Target Altitude	**	ALTV		
Glidepath	Captures and tracks the SBAS glidepath on approach	APR Key	GP		
Glideslope	Captures and tracks the ILS glideslope on approach		GS		
Takeoff	Commands a constant pitch angle and wings level on ground in preparation for takeoff	GA Button	TO	7°	
Go Around	Commands a constant pitch angle and wings level in the air		GA	7°	
Level	Maintains the current vertical speed reference	LVL Button	LVL		

* *ALTS armed automatically when PIT, VS, IAS, or GA active, and under VPTH when Selected Altitude is to be captured instead of VNV Target Altitude*

** *ALTV armed automatically under VPTH when VNV Target Altitude is to be captured instead of Selected Altitude*

Table 7-2 Flight Director Vertical Modes

PITCH HOLD MODE (PIT)

When the flight director is activated (the **FD** Key is pressed), Pitch Hold Mode is selected by default. Pitch Hold Mode is indicated as the active vertical mode by the green 'PIT' annunciation. This mode may be used for climb or descent to the Selected Altitude (shown above the Altimeter), since Selected Altitude Capture Mode is automatically armed when Pitch Hold Mode is activated.

In Pitch Hold Mode, the flight director maintains a constant pitch attitude. The pitch reference is set to the aircraft pitch attitude at the moment of mode selection. If the aircraft pitch attitude exceeds the flight director pitch command limitations, the flight director commands a pitch angle equal to the nose-up/down limit.

When operating in Pitch Hold Mode, the pitch reference can be adjusted by using the **NOSE UP/DN** Wheel.

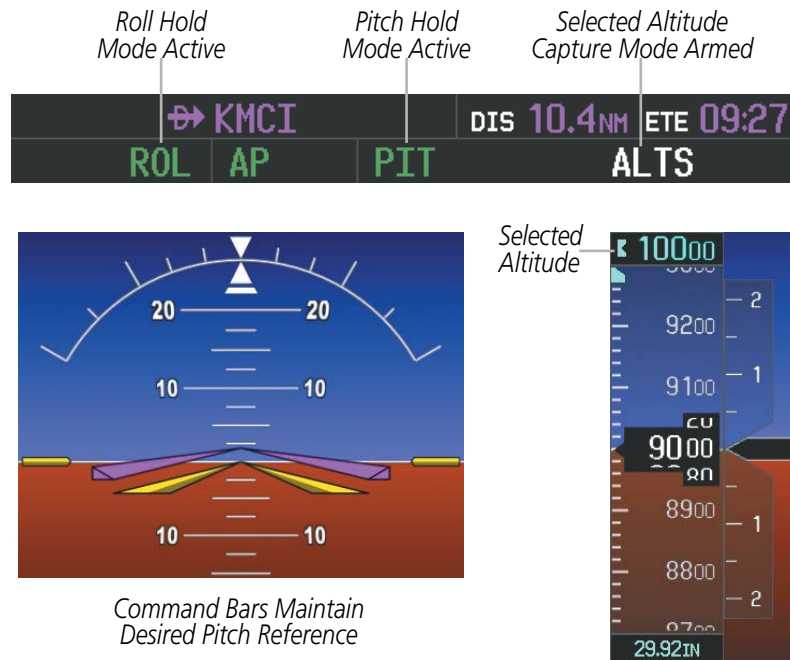

Figure 7-5 Pitch Hold Mode

SELECTED ALTITUDE CAPTURE MODE (ALTS)

Selected Altitude Capture Mode is automatically armed with activation of the following modes:

- Pitch Hold
- Vertical Speed
- Indicated Airspeed
- Go Around
- Vertical Path Tracking (if the Selected Altitude is to be captured instead of the VNV Target Altitude)

The white 'ALTS' annunciation indicates Selected Altitude Capture Mode is armed (see Figure 7-5 for example). The **ALT SEL** Knob is used to set the Selected Altitude (shown above the Altimeter) until Selected Altitude Capture Mode becomes active.

As the aircraft nears the Selected Altitude, the flight director automatically transitions to Selected Altitude Capture Mode with Altitude Hold Mode armed (Figure 7-6). This automatic transition is indicated by the green 'ALTS' annunciation flashing for up to 10 seconds and the appearance of the white 'ALT' annunciation. The Selected Altitude is shown as the Altitude Reference beside the 'ALTS' annunciation.

At 50 feet from the Selected Altitude, the flight director automatically transitions from Selected Altitude Capture to Altitude Hold Mode and holds the reference altitude. As Altitude Hold Mode becomes active, the white 'ALT' annunciation moves to the active vertical mode field and flashes green for 10 seconds to indicate the automatic transition.

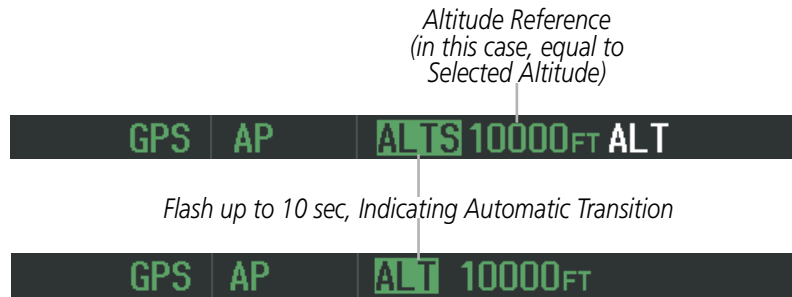

Figure 7-6 Automatic Mode Transitions During Altitude Capture

Use of the **ALT SEL** Knob to change the Selected Altitude while Selected Altitude Capture Mode is active causes the flight director to revert to Pitch Hold Mode with Selected Altitude Capture Mode armed for the new Selected Altitude.

ALTITUDE HOLD MODE (ALT)

Altitude Hold Mode can be activated by pressing the **ALT** Key; the flight director maintains the current aircraft altitude (to the nearest 10 feet) as the Altitude Reference. The flight director's Altitude Reference, shown in the AFCS Status Box, is independent of the Selected Altitude, displayed above the Altimeter. Altitude Hold Mode is indicated by a green 'ALT' annunciation in the AFCS Status Box.

Altitude Hold Mode is automatically armed when the flight director is in Selected Altitude Capture Mode (see Figure 7-6). Selected Altitude Capture Mode automatically transitions to Altitude Hold Mode when the altitude error is less than 50 feet. In this case, the Selected Altitude becomes the flight director's Altitude Reference.

When operating in Altitude Hold Mode, the reference altitude can be adjusted by using the **NOSE UP/DN** Wheel. The reference altitude can only be moved a maximum of 150 ft from the current aircraft altitude; each click changes the reference altitude by 10 ft.



NOTE: Turning the **ALT SEL** Knob while in Altitude Hold Mode changes the Selected Altitude, but not the flight director's Altitude Reference, and does not cancel the mode.

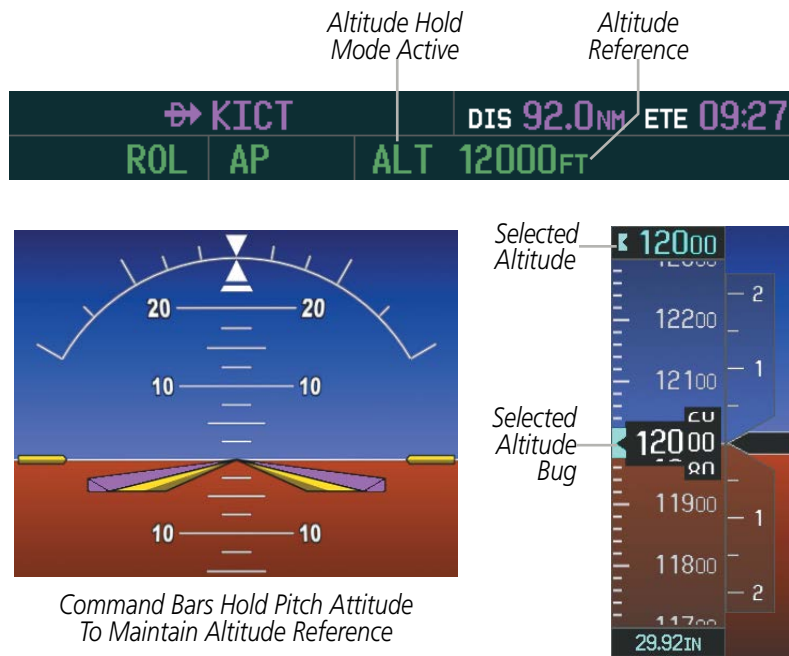

Figure 7-7 Altitude Hold Mode

- SYSTEM OVERVIEW
- FLIGHT INSTRUMENTS
- EIS
- AUDIO PANEL & CNS
- FLIGHT MANAGEMENT
- HAZARD AVOIDANCE
- AFCS
- ADDITIONAL FEATURES
- APPENDICES
- INDEX

VERTICAL SPEED MODE (VS)

In Vertical Speed Mode, the flight director acquires and maintains a Vertical Speed Reference. Current aircraft vertical speed (to the nearest 100 fpm) becomes the Vertical Speed Reference at the moment of Vertical Speed Mode activation. This mode may be used for climb or descent to the Selected Altitude (shown above the Altimeter) since Selected Altitude Capture Mode is automatically armed when Vertical Speed Mode is selected.

When Vertical Speed Mode is activated by pressing the **VS** Key, 'VS' is annunciated in green in the AFCS Status Box along with the Vertical Speed Reference. The Vertical Speed Reference is also displayed above the Vertical Speed Indicator. A Vertical Speed Reference Bug corresponding to the Vertical Speed Reference is shown on the indicator.

The Vertical Speed Reference (shown both in the AFCS Status Box and above the Vertical Speed Indicator) may be changed by using the **NOSE UP/DN** Wheel.

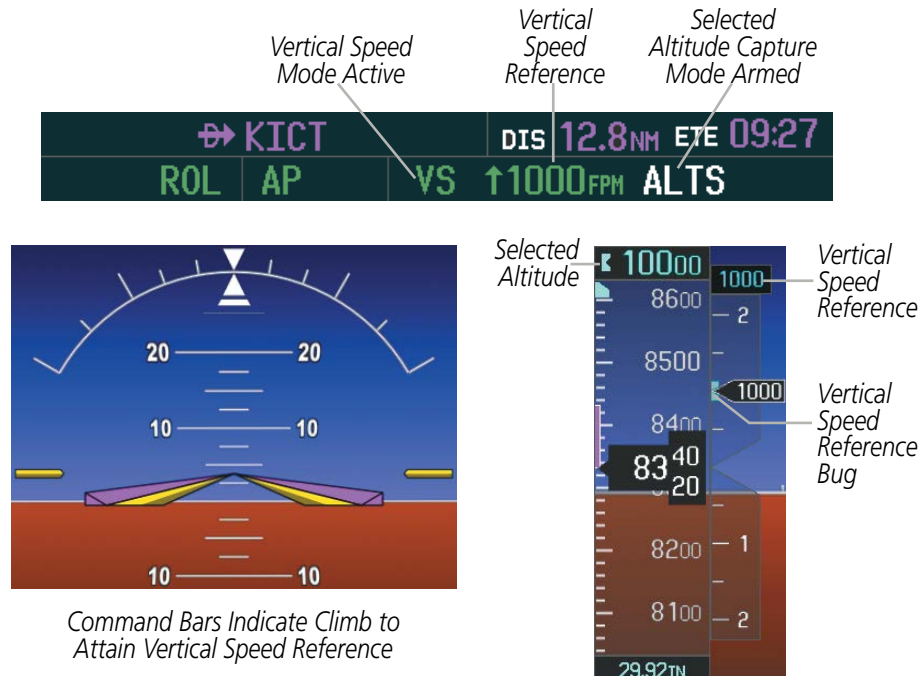

Figure 7-8 Vertical Speed Hold Mode

INDICATED AIRSPEED MODE (IAS)



NOTE: The Selected Altitude should be set before selecting Indicated Airspeed Mode (IAS).

Indicated Airspeed Mode is selected by pressing the **IAS** Key. This mode acquires and maintains the Airspeed Reference (IAS) while climbing or descending to the Selected Altitude (shown above the Altimeter). When Indicated Airspeed Mode is active, the flight director continuously monitors Selected Altitude, airspeed and altitude.

The Airspeed Reference is set to the current airspeed upon mode activation. Indicated Airspeed Mode is indicated by a green 'IAS' annunciation beside the Airspeed Reference in the AFCS Status Box. The Airspeed Reference is also displayed directly above the Airspeed Indicator, along with a bug corresponding to the Airspeed Reference along the tape.

Engine power must be adjusted to allow the autopilot to fly the aircraft at a pitch attitude corresponding to the desired flight profile (climb or descent) while maintaining the Airspeed Reference.

The Airspeed Reference (shown in both the AFCS Status Box and above the Airspeed Indicator) may be adjusted by using the **NOSE UP/DN** Wheel.

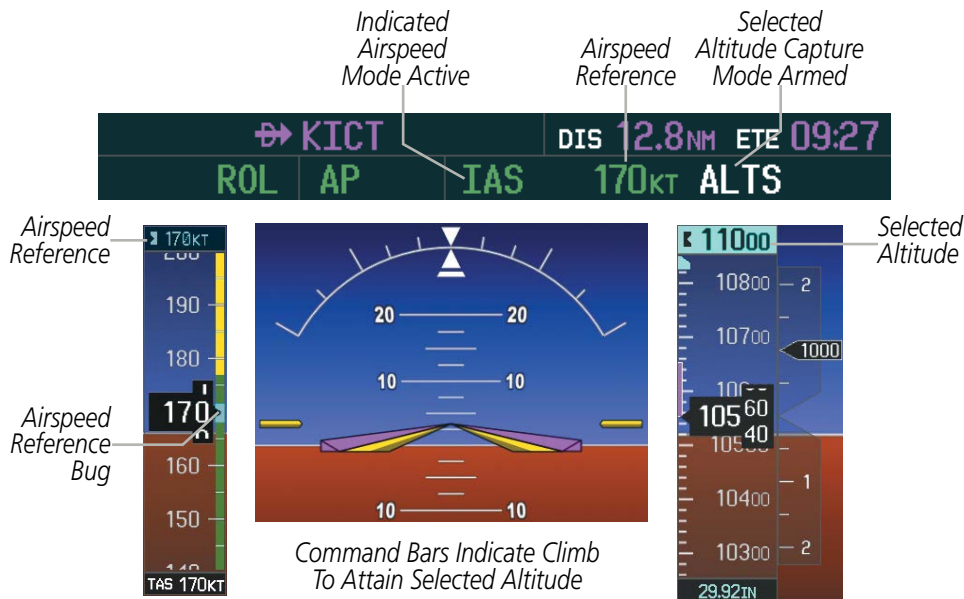

Figure 7-9 Indicated Airspeed Mode (IAS)

- SYSTEM OVERVIEW
- FLIGHT INSTRUMENTS
- EIS
- AUDIO PANEL & CNS
- FLIGHT MANAGEMENT
- HAZARD AVOIDANCE
- AFCS
- ADDITIONAL FEATURES
- APPENDICES
- INDEX

VERTICAL NAVIGATION MODES (VPTH, ALTV)



NOTE: VNV is disabled when parallel track or Dead Reckoning Mode is active.



NOTE: The Selected Altitude takes precedence over any other vertical constraints.

Vertical Navigation (VNV) flight control is available for enroute/terminal cruise and descent operations any time that VNV flight planning is available. Refer to the Flight Management Section for more information on VNV flight plans. Conditions for availability include, but are not limited to:

- The selected navigation source is GPS.
- A VNV flight plan (with at least one altitude-constrained waypoint) or vertical direct-to is active.
- VNV is enabled (**ENBL VNV** Softkey pressed on the MFD).
- Crosstrack error is valid and within certain limits.
- Desired/actual track are valid or track angle error is within certain limits.
- The VNV Target Altitude of the active waypoint is no more than 250 ft above the current aircraft altitude.

The flight director may be armed for VNV at any time, but no target altitudes are captured during a climb. The Command Bars provide vertical profile guidance based on specified altitudes (entered manually or loaded from the database) at waypoints in the active flight plan or vertical direct-to. The appropriate VNV flight control modes are sequenced by the flight director to follow the path defined by the vertical profile. Upon reaching the last waypoint in the VNV flight plan, the flight director transitions to Altitude Hold Mode and cancels any armed VNV modes.

VERTICAL PATH TRACKING MODE (VPTH)



NOTE: If another vertical mode key is pressed while Vertical Path Tracking Mode is selected, Vertical Path Tracking Mode reverts to armed.

When a vertical profile (VNV flight plan) is active and the **VNV** Key is pressed, Vertical Path Tracking Mode is armed in preparation for descent path capture. ‘VPTH’ (or ‘V’ when Glidepath or Glideslope Mode is concurrently armed) is annunciated in white in addition to previously armed modes. If applicable, the appropriate altitude capture mode is armed for capture of the next VNV Target Altitude (ALTV) or the Selected Altitude (ALTS), whichever is greater.

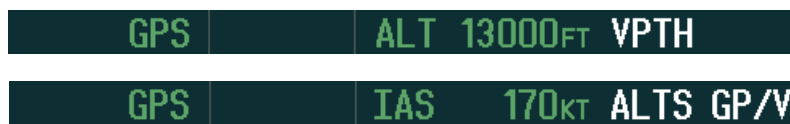

Figure 7-10 Vertical Path Tracking Armed Annunciations

Prior to descent path interception, the Selected Altitude must be set below the current aircraft altitude by at least 75 feet. In conjunction with the “TOD [top of descent] within 1 minute” annunciation in the PFD Navigation Status Box and the “Vertical track” voice message, VNV indications (VNV Target Altitude, vertical deviation, and vertical speed required) appear on the PFD in magenta (Figure 7-11).

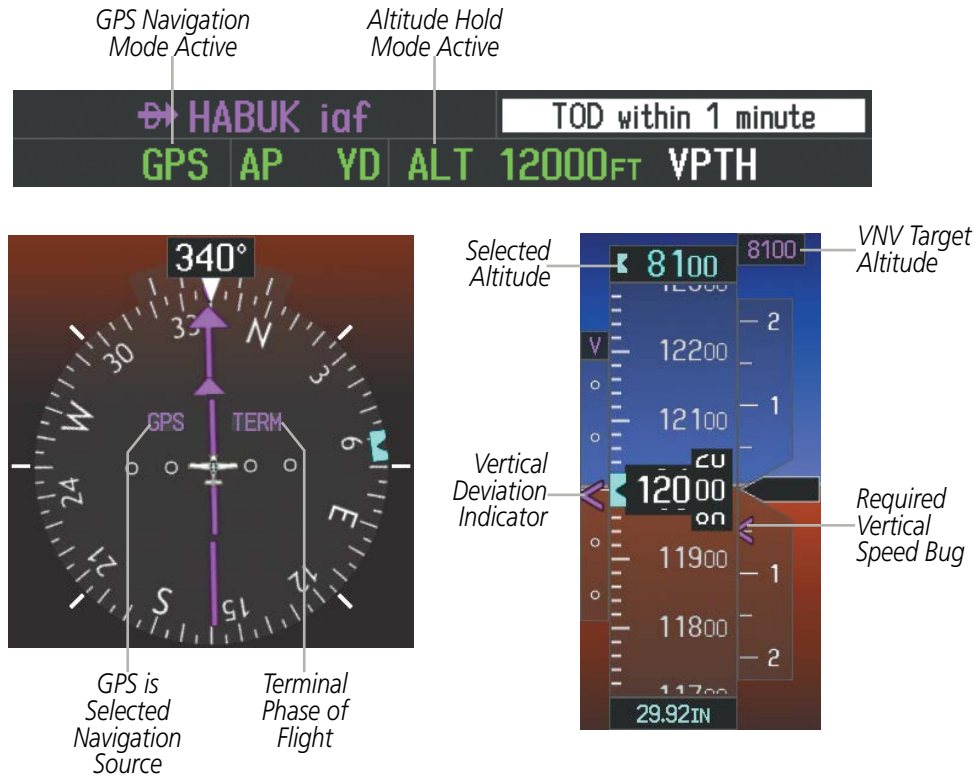

Figure 7-11 Vertical Path Capture

- SYSTEM OVERVIEW
- FLIGHT INSTRUMENTS
- EIS
- AUDIO PANEL & CNS
- FLIGHT MANAGEMENT
- HAZARD AVOIDANCE
- AFCS
- ADDITIONAL FEATURES
- APPENDICES
- INDEX

When a descent leg is captured (i.e., vertical deviation becomes valid), Vertical Path Tracking becomes active and tracks the descent profile (Figure 7-12). An altitude capture mode ('ALTS' or 'ALTV') is armed as appropriate.

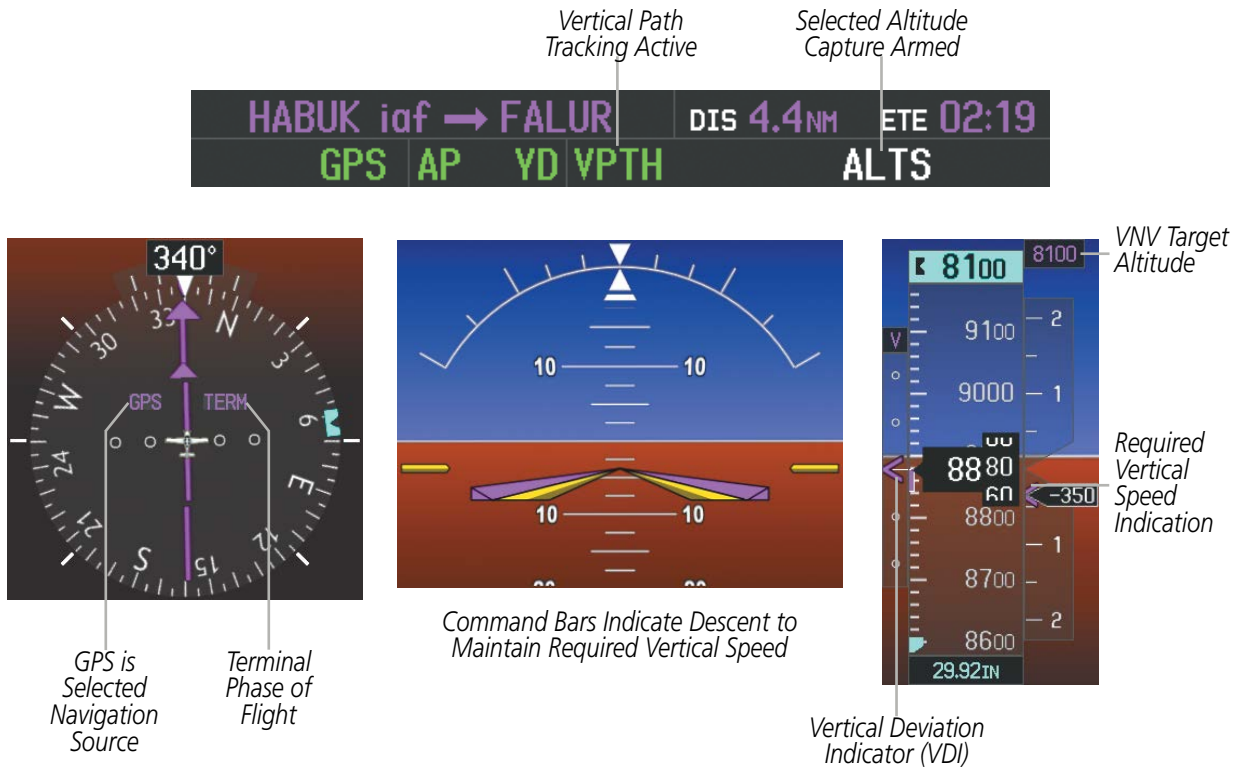

Figure 7-12 Vertical Path Tracking Mode

If the altimeter barometric setting is adjusted while Vertical Path Tracking is active, the flight director increases/decreases the descent rate by up to 500 fpm to re-establish the aircraft on the descent path (without commanding a climb). Adjusting the altimeter barometric setting creates discontinuities in VNV vertical deviation, moving the descent path. For large adjustments, it may take several minutes for the AFCS to re-establish on the descent path. If the change is made while nearing a waypoint with a VNV Target Altitude, the aircraft may not re-establish on the descent path in time to meet the vertical constraint.

Automatic Reversion to Pitch Hold Mode

Several situations can occur while Vertical Path Tracking Mode is active which cause the flight director to revert to Pitch Hold Mode:

- Vertical deviation exceeds 200 feet during an overspeed condition.
- Vertical deviation experiences a discontinuity that both exceeds 200 feet in magnitude and results in the vertical deviation exceeding 200 feet in magnitude. Such discontinuities are usually caused by flight plan changes that affect the vertical profile.
- Vertical deviation becomes invalid (the Vertical Deviation Indicator is removed from the PFD).
- A display enters Reversionary Mode (this does not apply to an active vertical direct-to).

Unless VNV is disabled, Vertical Path Tracking Mode and the appropriate altitude capture mode become armed following the reversion to Pitch Hold Mode to allow for possible profile recapture.

Non-Path Descents

Pitch Hold, Vertical Speed, and Indicated Airspeed modes can also be used to fly non-path descents while VNV flight control is selected. If the **VS** or **IAS** Key is pressed while Vertical Path Tracking Mode is selected, Vertical Path Tracking Mode reverts to armed along with the appropriate altitude capture mode to allow profile re-capture.



Figure 7-13 Indicated Airspeed Mode VNV Non-Path Descent

To prevent immediate profile re-capture, the following must be satisfied:

- At least 10 seconds have passed since the non-path transition was initiated
- Vertical deviation from the profile has exceeded 250 feet, but is now less than 200 feet

Pressing the **VNV** Key twice re-arms Vertical Path Tracking for immediate profile re-capture.

VNV TARGET ALTITUDE CAPTURE MODE (ALTV)



NOTE: Armed VNV Target Altitude and Selected Altitude capture modes are mutually exclusive. However, Selected Altitude Capture Mode is armed implicitly (not annunciated) whenever VNV Target Altitude Capture Mode is armed.

VNV Target Altitude Capture is analogous to Selected Altitude Capture Mode and is armed automatically after the VNV Key is pressed and the next VNV Target Altitude is to be intercepted before the Selected Altitude. The annunciation 'ALTV' indicates that the VNV Target Altitude is to be captured. VNV Target Altitudes are shown in the active flight plan or vertical direct-to, and can be entered manually or loaded from a database (see the Flight Management Section for details). At the same time as "TOD within 1 minute" is annunciated in the Navigation Status Box, the active VNV Target Altitude is displayed above the Vertical Speed Indicator (see Figure 7-11).



NOTE: When the Selected Altitude is set to the VNV Target Altitude, Selected Altitude Capture Mode (ALTS) will be armed even though the altitude value is part of the active VNAV flight plan.

As the aircraft nears the VNV Target Altitude, the flight director automatically transitions to VNV Target Altitude Capture Mode with Altitude Hold Mode armed. This automatic transition is indicated by the green 'ALTV' annunciation flashing for up to 10 seconds and the appearance of the white 'ALT' annunciation. The VNV Target Altitude is shown as the Altitude Reference beside the 'ALTV' annunciation and remains displayed above the Vertical Speed Indicator. The Required Vertical Speed Indication (RVSI) is removed once VNV Target Altitude Capture Mode becomes active.

At 50 feet from the VNV Target Altitude, the flight director automatically transitions from VNV Target Altitude Capture to Altitude Hold Mode and tracks the level leg. As Altitude Hold Mode becomes active, the white 'ALT' annunciation moves to the active vertical mode field and flashes green for 10 seconds to indicate the automatic transition. The flight director automatically arms Vertical Path Tracking, allowing upcoming descent legs to be captured and subsequently tracked.

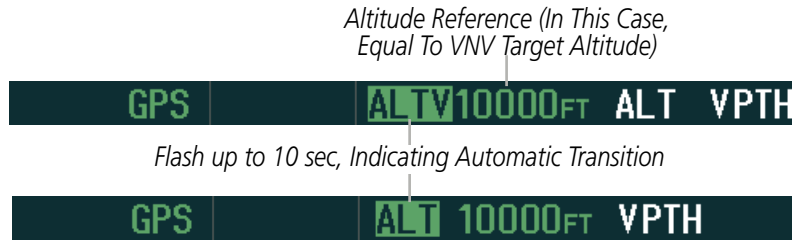

Figure 7-14 Automatic Mode Transitions During Altitude Capture

Changing the current VNV Target Altitude while VNV Target Altitude Capture Mode is active causes the flight director to revert to Pitch Hold Mode. Vertical Path Tracking and the appropriate altitude capture mode are armed in preparation to capture the new VNV Target Altitude or the Selected Altitude, depending on which altitude is to be intercepted first.

VNV target altitudes can be changed while editing the active flight plan (see the Flight Management Section for details).

GLIDEPATH MODE (GP)

Glidepath Mode is used to track the SBAS-based glidepath. When Glidepath Mode is armed, ‘GP’ is annunciated in white in the AFCS Status Box.

Selecting Glidepath Mode:

- 1) Ensure a GPS approach with vertical guidance (LPV, LNAV/VNAV, LNAV +V, LP+V) is loaded into the active flight plan. The active waypoint must be part of the flight plan (cannot be a direct-to a waypoint not in the flight plan).
- 2) Ensure that GPS is the selected navigation source (use the **CDI** Softkey to cycle through navigation sources if necessary).
- 3) Press the **APR** Key.

NOTE: Some RNAV (GPS) approaches provide a vertical descent angle as an aid in flying a stabilized approach. These approaches are NOT considered Approaches with Vertical Guidance (APV). Approaches that are annunciated on the HSI as LNAV or LNAV+V are considered Nonprecision Approaches (NPA) and are flown to an MDA even though vertical glidepath (GP) information may be provided.

WARNING: When flying an LNAV approach (with vertical descent angle) with the autopilot coupled, the aircraft will not level off at the MDA even if the MDA is set in the altitude preselect.

Upon reaching the glidepath, the flight director transitions to Glidepath Mode and begins to capture and track the glidepath.



Figure 7-15 Glidepath Mode Armed

Once the following conditions have been met, the glidepath can be captured:

- The active waypoint is at or after the final approach fix (FAF).
- Vertical deviation is valid.
- The CDI is at less than full-scale deviation
- Automatic sequencing of waypoints has not been suspended (no ‘SUSP’ annunciation on the HSI)

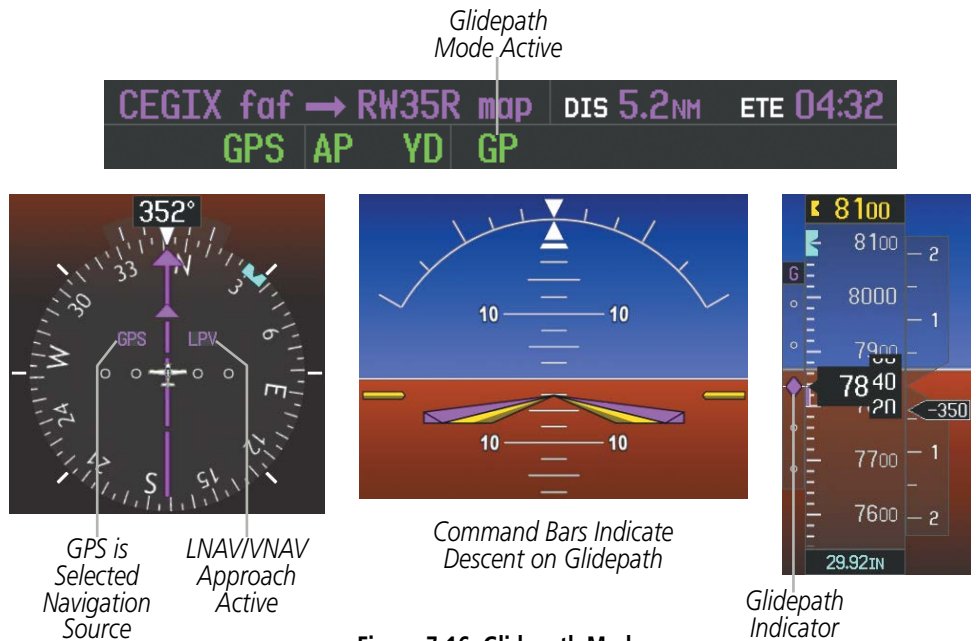

Figure 7-16 Glidepath Mode

GLIDESLOPE MODE (GS)

Glideslope Mode is available for LOC/ILS approaches to capture and track the glideslope. When Glideslope Mode is armed (annunciated as ‘GS’ in white), LOC Approach Mode is armed as the lateral flight director mode.

- SYSTEM OVERVIEW
- FLIGHT INSTRUMENTS
- EIS
- AUDIO PANEL & CNS
- FLIGHT MANAGEMENT
- HAZARD AVOIDANCE
- AFCS
- ADDITIONAL FEATURES
- APPENDICES
- INDEX

Selecting Glideslope Mode:

- 1) Ensure a valid localizer frequency is tuned.
 - 2) Ensure that LOC is the selected navigation source (use the **CDI** Softkey to cycle through navigation sources if necessary).
 - 3) Press the **APR** Key.
- Or:**
- 1) Ensure that GPS is the selected navigation source (use the **CDI** Softkey to cycle through navigation sources if necessary).
 - 2) Ensure a LOC/ILS approach is loaded into the active flight plan.
 - 3) Ensure the corresponding LOC frequency is tuned.
 - 4) Press the **APR** Key.



Figure 7-17 Glideslope Mode Armed

Once LOC is the navigation source, the localizer and glideslope can be captured. Upon reaching the glideslope, the flight director transitions to Glideslope Mode and begins to capture and track the glideslope.

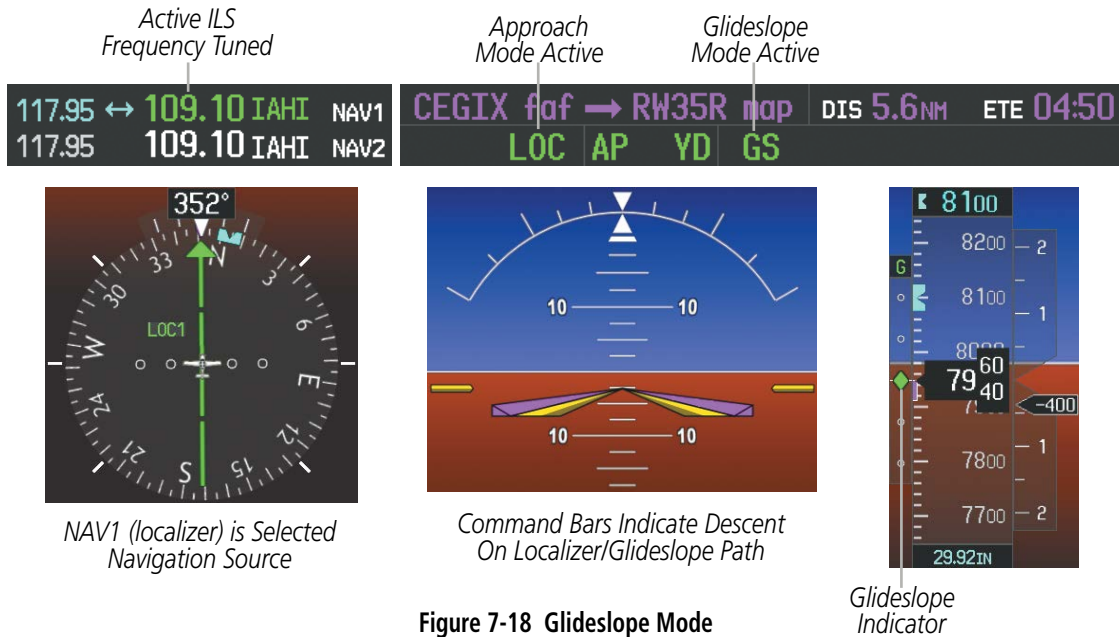

Figure 7-18 Glideslope Mode

GO AROUND (GA) AND TAKEOFF (TO) MODES

Go Around and Takeoff modes are coupled pitch and roll modes and are annunciated as both the vertical and lateral modes when active. In these modes, the flight director commands a constant set pitch attitude and keeps the wings level. The GA Switch is used to activate both modes. The mode entered by the flight director depends on whether the aircraft is on the ground or in the air.

Takeoff Mode provides an attitude reference during rotation and takeoff. This mode can be selected only while on the ground by pushing the GA Switch. The flight director Command Bars assume a wings-level, pitch-up attitude.

Pressing the **GA** Button while in the air activates the flight director in a wings-level, pitch-up attitude, allowing the execution of a missed approach or a go around. Go Around Mode arms Selected Altitude Capture Mode automatically, and attempts to modify the aircraft attitude (i.e., with the **NOSE UP/DN** Wheel) resulting in reversion to Pitch and Roll Hold modes.

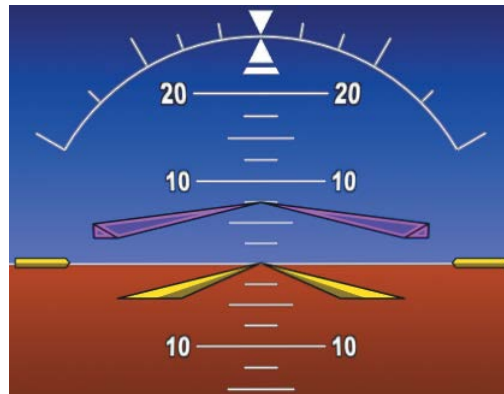
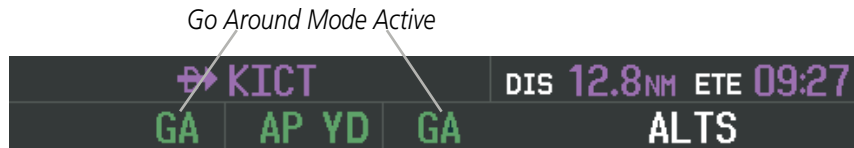

Command Bars Indicate Climb



Figure 7-19 Go Around and Takeoff Modes

LATERAL MODES

The following table relates each AFCS lateral mode to its respective control and annunciation. Refer to the vertical modes section for information regarding Takeoff and Go Around Modes.

 **NOTE:** The AFCS may generate a lower bank angle than the maximum roll command limit in degrees indicated in Table 7-3 by the amount needed to produce a turn rate equal to or less than standard rate.

Lateral Mode	Description	Control	Annunciation	Maximum Roll Command Limit
Roll Hold	Holds the current aircraft roll attitude or rolls the wings level, depending on the commanded bank angle	(default)	ROL	25°
Heading Select	Captures and tracks the Selected Heading	HDG Key	HDG	25°
Navigation, GPS	Captures and tracks the selected navigation source (GPS, VOR, LOC)	NAV Key	GPS	25°
Navigation, VOR Enroute Capture/Track			VOR	25° Capture 10° Track
Navigation, LOC Capture/Track (No Glideslope)			LOC	25° Capture 10° Track
Navigation, Backcourse Capture/Track			BC	25° Capture 10° Track
Approach, GPS	Captures and tracks the selected navigation source (GPS, VOR, LOC)	APR Key	GPS	25°
Approach, VOR Capture/Track			VAPP	25° Capture 10° Track
Approach, LOC Capture/Track (Glideslope Mode automatically armed)			LOC	25° Capture 10° Track
Takeoff	Commands a constant pitch angle and wings level on ground in preparation for takeoff	GA Button	TO	Wings Level
Go Around	Commands a constant pitch angle and wings level in the air		GA	Wings Level
Level	Maintains wings level	LVL Button	LVL	Wings Level

The AFCS limits turn rate to 3 degrees per second (standard rate turn).

Table 7-3 Flight Director Lateral Modes

SYSTEM OVERVIEW

FLIGHT INSTRUMENTS

EIS

AUDIO PANEL & CNS

FLIGHT MANAGEMENT

HAZARD AVOIDANCE

AFCS

ADDITIONAL FEATURES

APPENDICES

INDEX

ROLL HOLD MODE (ROL)



NOTE: If Roll Hold Mode is activated as a result of a mode reversion, the flight director rolls the wings level.

When the flight director is activated or switched, Roll Hold Mode is selected by default. This mode is annunciated as 'ROL' in the AFCS Status Box. The current aircraft bank angle is held, subject to the bank angle condition.



Figure 7-20 Roll Hold Mode Annunciation

Bank Angle	Flight Director Response
< 6°	Rolls wings level
6 to 25°	Maintains current aircraft roll attitude
>25°	Limits bank to 25°

Table 7-4 Roll Hold Mode Responses

- SYSTEM OVERVIEW
- FLIGHT INSTRUMENTS
- EIS
- AUDIO PANEL & CNS
- FLIGHT MANAGEMENT
- HAZARD AVOIDANCE
- AFCS
- ADDITIONAL FEATURES
- APPENDICES
- INDEX

HEADING SELECT MODE (HDG)

Heading Select Mode is activated by pressing the **HDG** Key. Heading Select Mode acquires and maintains the Selected Heading. The Selected Heading is shown by a light blue bug on the HSI and in the box to the upper left of the HSI.



NOTE: Pushing the **HDG** Knob synchronizes the Selected Heading to the current heading.

The Selected Heading is adjusted using the **HDG** Knob. Turns are commanded in the same direction as Selected Heading Bug movement, even if the bug is turned more than 180° from the present heading (e.g., a 270° turn to the right). However, Selected Heading changes of more than 330° at a time result in turn reversals.

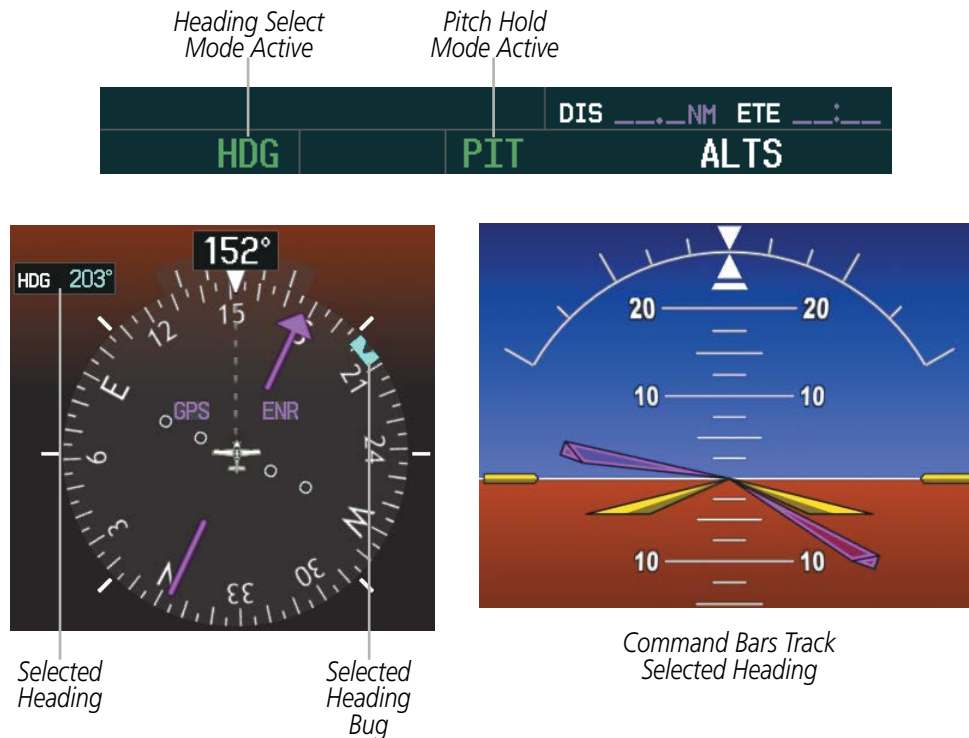

Figure 7-21 Heading Select Mode

NAVIGATION MODES (GPS, VOR, LOC, BC)

NOTE: The selected navigation receiver must have a valid VOR or LOC signal or active GPS course for the flight director to enter Navigation Mode.

NOTE: When intercepting a flight plan leg, the flight director gives commands to capture the active leg at approximately a 45° angle to the track between the waypoints defining the active leg. The flight director does not give commands fly to the starting waypoint of the active leg.

NOTE: When making a backcourse approach, set the Selected Course to the localizer front course.

Pressing the **NAV** Key selects Navigation Mode. Navigation Mode acquires and tracks the selected navigation source (GPS, VOR, LOC). The flight director follows GPS roll steering commands when GPS is the selected navigation source. When the navigation source is VOR or LOC, the flight director creates roll steering commands from the Selected Course and deviation. Navigation Mode can also be used to fly non-precision GPS and LOC approaches where vertical guidance is not required.

Backcourse Navigation Mode is selected when the localizer front course is greater than 105° from the aircraft heading. Backcourse Navigation Mode captures and tracks a localizer signal in the backcourse direction. The annunciation 'BC' in the AFCS Status Box indicates Backcourse Navigation Mode (Figure 7-24).

If the Course Deviation Indicator (CDI) shows greater than one dot when the **NAV** Key is pressed, the selected mode is armed. If the CDI is less than one dot, Navigation Mode is automatically captured when the **NAV** Key is pressed. The armed annunciation appears in white to the left of the active roll mode



Figure 7-22 GPS Navigation Mode Armed

When the CDI has automatically switched from GPS to LOC during a LOC/ILS approach, GPS Navigation Mode remains active, providing GPS steering guidance until the localizer signal is captured. LOC Navigation Mode is armed when the automatic navigation source switch takes place. If the **APR** Key is pressed prior to the automatic navigation source switch, LOC Navigation Mode is armed.

If Navigation Mode is active and either of the following occur, the flight director reverts to Roll Hold Mode (wings rolled level):

- Different VOR tuned while in VOR Navigation Mode (VOR Navigation Mode reverts to armed)
- Navigation source manually switched (with the **CDI** Softkey)
- During a LOC/ILS approach, the FAF is crossed while in GPS Navigation Mode after the automatic navigation source switch from GPS to LOC

SYSTEM OVERVIEW

FLIGHT INSTRUMENTS

EIS

AUDIO PANEL & CNS

FLIGHT MANAGEMENT

HAZARD AVOIDANCE

AFCS

ADDITIONAL FEATURES

APPENDICES

INDEX

If the navigation source is VOR or localizer, or OBS Mode has been enabled when using GPS, the Selected Course is controlled using the **CRS** Knob.

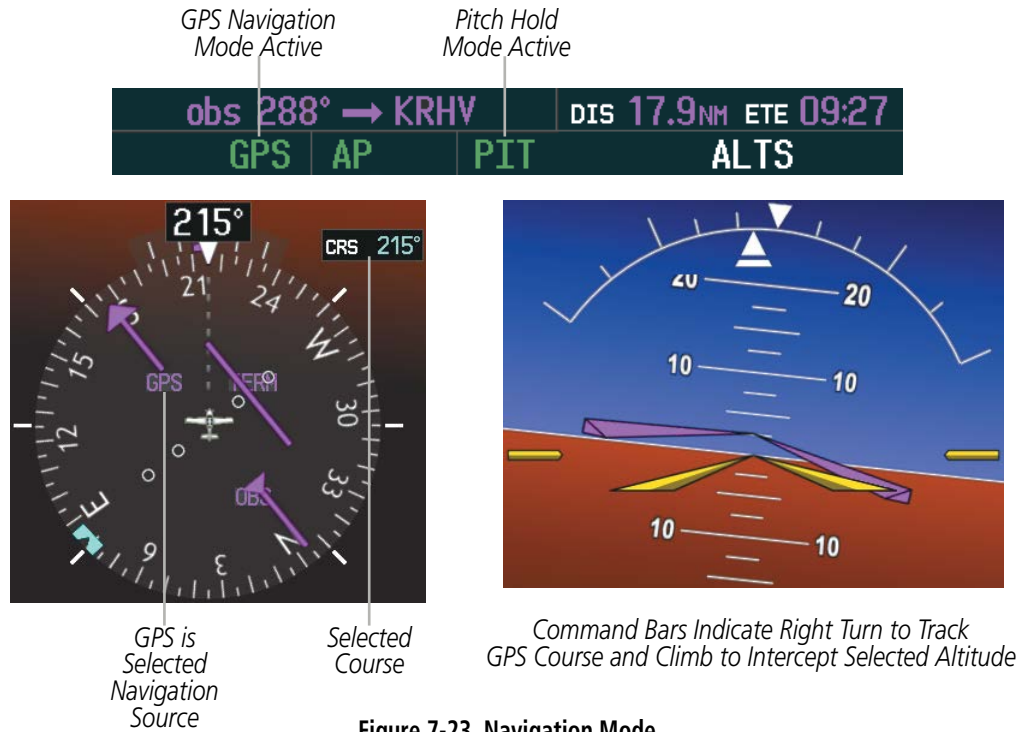

Figure 7-23 Navigation Mode

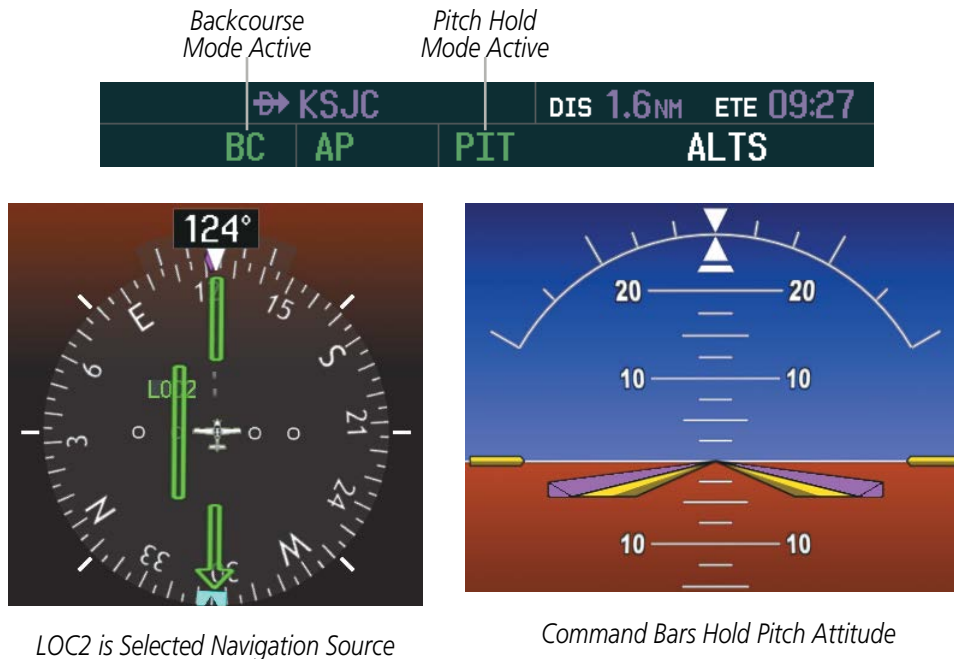

Figure 7-24 Backcourse Mode

APPROACH MODES (GPS, VAPP, LOC)



NOTE: *The selected navigation receiver must have a valid VOR or LOC signal or active GPS course for the flight director to enter Approach Mode.*

Approach Mode is activated when the **APR** Key is pressed. Approach Mode acquires and tracks the selected navigation source (GPS, VOR, or LOC), depending on loaded approach. This mode uses the selected navigation receiver deviation and desired course inputs to fly the approach. Pressing the **APR** Key when the CDI is greater than one dot arms the selected approach mode (annunciated in white to the left of the active lateral mode). If the CDI is less the 1 dot, the LOC is automatically captured when the **APR** Key is pressed.

VOR Approach Mode (VAPP) provides greater sensitivity for signal tracking than VOR Navigation Mode.

Selecting VOR Approach Mode:

- 1) Ensure a valid VOR frequency is tuned
- 2) Ensure that VOR is the selected navigation source (use the **CDI** Softkey to cycle through navigation sources if necessary).
- 3) Press the **APR** Key.

When GPS Approach Mode is armed, Glidepath Mode is also armed.

Selecting GPS Approach Mode:

- 1) Ensure a GPS approach is loaded into the active flight plan. The active waypoint must be part of the flight plan (cannot be a direct-to a waypoint not in the flight plan).
- 2) Ensure that GPS is the selected navigation source (use the **CDI** Softkey to cycle through navigation sources if necessary).
- 3) Press the **APR** Key.



Figure 7-25 GPS Approach Mode Armed

LOC Approach Mode allows the autopilot to fly a LOC/ILS approach with a glideslope. When LOC Approach Mode is armed, Glideslope Mode is also armed automatically. LOC captures are inhibited if the difference between aircraft heading and localizer course exceeds 105°.

Selecting LOC Approach Mode:

- 1) Ensure a valid localizer frequency is tuned.
- 2) Ensure that LOC is the selected navigation source (use the **CDI** Softkey to cycle through navigation sources if necessary).
- 3) Press the **APR** Key.

Or:

SYSTEM OVERVIEW

FLIGHT INSTRUMENTS

EIS

AUDIO PANEL & CNS

FLIGHT MANAGEMENT

HAZARD AVOIDANCE

AFCS

ADDITIONAL FEATURES

APPENDICES

INDEX

- 1) Ensure that GPS is the selected navigation source (use the **CDI** Softkey to cycle through navigation sources if necessary).
- 2) Ensure a LOC/ILS approach is loaded into the active flight plan.
- 3) Ensure the corresponding LOC frequency is tuned.
- 4) Press the **APR** Key.

If the following occurs, the flight director reverts to Roll Hold Mode (wings rolled level):

- Approach Mode is active and a Vectors-To-Final is activated
- Approach Mode is active and Navigation source is manually switched
- During a LOC/ILS approach, GPS Navigation Mode is active and the FAF is crossed after the automatic navigation source switch from GPS to LOC

If the navigation source is VOR or localizer, or OBS Mode has been enabled when using GPS, the Selected Course is controlled using the **CRS** Knob.

LEVEL MODE

Level Mode is coupled pitch and roll modes and is annunciated as both the vertical and lateral modes when active. Pressing the **LVL** Key engages the autopilot (if the autopilot is disengaged) in level vertical and lateral modes. Level Mode does not track altitude or heading. When the **LVL** Key is pressed all armed and active modes are cancelled and the autopilot and flight director revert to LVL mode for pitch and roll (Figure 7-26). While in level mode, all other modes are available by pressing the corresponding button.

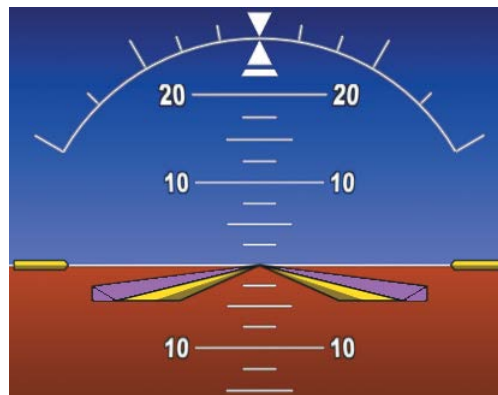

Command Bars Indicate Level with the Horizon

Figure 7-26 Level Mode Annunciation

INTERCEPTING AND FLYING A DME ARC

The AFCS will intercept and track a DME arc that is part of the active flight plan provided that GPS Navigation Mode is engaged, GPS is the active navigation source on the CDI, and the DME arc segment is the active flight plan leg. It is important to note that automatic navigation of DME arcs is based on GPS. Thus, even if the APR key is pressed and LOC or VOR Approach Mode is armed prior to reaching the Initial Approach Fix (IAF), Approach Mode will not activate until the arc segment is completed.

If the pilot decides to intercept the arc at a location other than the published IAF (i.e. ATC provides vectors to intercept the arc) and subsequently selects Heading Mode or Roll Mode, the AFCS will not automatically intercept or track the arc unless the pilot activates the arc leg of the flight plan and arms GPS Navigation Mode. The AFCS will not intercept and fly a DME arc before reaching an IAF that defines the beginning of the arc segment. Likewise, if at any point while established on the DME arc the pilot deselects GPS Navigation Mode, the AFCS will no longer track the arc.

AUTOPILOT AND YAW DAMPER OPERATION



NOTE: Refer to the POH for specific instructions regarding emergency procedures.

The autopilot and optional yaw damper (not available in the SR20) operate the flight control surface servos to provide automatic flight control. The autopilot controls the aircraft pitch and roll attitudes following commands received from the flight director. Pitch autotrim provides trim commands to the pitch trim servo to relieve any sustained effort required by the pitch servo. Autopilot operation is independent of the yaw damper.

The yaw damper reduces Dutch roll tendencies, coordinates turns, and provides a steady force to maintain directional trim. It can operate independently of the autopilot and may be used during normal hand-flight maneuvers. Yaw rate commands are limited to 6 deg/sec by the yaw damper.

FLIGHT CONTROL

Pitch and roll commands are provided to the servos based on the active flight director modes. Yaw commands are provided by the yaw servo. Servo motor control limits the maximum servo speed and torque. The servo mounts are equipped with slip-clutches set to certain values. This allows the servos to be overridden in case of an emergency.

PITCH AXIS AND TRIM

The autopilot pitch axis uses pitch rate to stabilize the aircraft pitch attitude during flight director maneuvers. Flight director pitch commands are rate and attitude-limited, combined with pitch damper control, and sent to the pitch servo motor. The pitch servo measures the output effort (torque) and provides this signal to the pitch trim servo. The pitch trim servo commands the motor to reduce the average pitch servo effort.

When the autopilot is not engaged, the pitch trim adapter may be used to provide manual electric trim (MET). This allows the aircraft to be trimmed using a control stick switch. Manual trim commands are generated only when the **MET** Switch is pressed. Trim speeds are coupled with airspeed to provide a more consistent response.



NOTE: When the autopilot is engaged, the MET Switch does not respond.

ROLL AXIS

The autopilot roll axis uses roll rate to stabilize aircraft roll attitude during flight director maneuvers. The flight director roll commands are rate- and attitude-limited, combined with roll damper control, and sent to the roll servo motor.

YAW AXIS

The yaw damper uses yaw rate and roll attitude to dampen the aircraft’s natural Dutch roll response. It also uses lateral acceleration to coordinate turns and reduce or eliminate the need for the pilot to use rudder pedal force to maintain coordinated flight during climbs and descents.

ENGAGEMENT

When the **AP** Key is pressed, the autopilot, yaw damper, and flight director (if not already active) are activated. The flight director engages in Pitch and Roll Hold Modes when initially activated. When the **YD** Key is pressed, the system engages the yaw damper independently of the autopilot (if not already engaged). Autopilot and yaw damper status are displayed in the center of the AFCS Status Box. Engagement is indicated by green ‘AP’ and ‘YD’ annunciations, respectively.



Figure 7-27 Autopilot and Yaw Damper Engaged

DISENGAGEMENT



NOTE: The autopilot does not disengage when the MET Switch is pressed.

Pushing the **AP** Key on the AFCS Control Panel disengages the autopilot. Manual autopilot disengagement is indicated by a five-second flashing yellow ‘AP’ annunciation and a three-second autopilot disconnect aural alert.

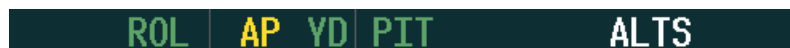

Figure 7-28 Manual Autopilot Disengagement

Pushing the **AP DISC** button disengages the autopilot, yaw damper, and flight director. Pushing the **YD** Key disengages the yaw damper and the autopilot. When the yaw damper and autopilot are manually disengaged, both the ‘AP’ and ‘YD’ annunciation turn yellow and flash for 5 seconds and a three-second autopilot disconnect aural alert is generated.



Figure 7-29 Autopilot and Yaw Damper Disengagement

After manual disengagement, the autopilot disconnect aural alert and the flashing ‘AP’ annunciation may be cancelled by pushing the **AP DISC** Button.

Automatic autopilot disengagement is indicated by a flashing red and white ‘AP’ annunciation and by the autopilot disconnect aural alert, which continue until acknowledged by pushing the **AP DISC** Button. Automatic autopilot disengagement occurs due to:

- System failure
- Inability to compute default flight director modes (FD also disengages automatically)
- Invalid sensor data

Yaw damper disengagement is indicated by a five-second flashing yellow ‘YD’ annunciation. Automatic yaw damper disengagement occurs when the aircraft descends below 200 ft AGL or when the autopilot disengagement is caused by failure in a parameter also affecting the yaw damper. This means the yaw damper can remain operational in some cases where the autopilot automatically disengages. A localized failure in the yaw damper system or invalid sensor data may also cause yaw damper disengagement.



Figure 7-30 Automatic Autopilot and Yaw Damper Disengagement

REVERSIONARY MODE

In the event of a PFD failure, the MFD goes into reversionary mode. The autopilot remains engaged but reverts to pitch hold and roll hold modes; all other modes are available for selection. If the MFD fails, the PFD goes into reversionary mode and the autopilot continues to function.

EXAMPLE FLIGHT PLAN



NOTE: The following example flight plan and diagrams (not to be used for navigation) in this section are for instructional purposes only and should be considered not current. Numbered portions of accompanying diagrams correspond to numbered procedure steps.

This scenario-based set of procedures (based on the example flight plan found in the Flight Management Section) shows various GFC 700 AFCS modes used during a flight. In this scenario, the aircraft departs Charles B. Wheeler Downtown Airport (KMKC), enroute to Colorado Springs Airport (KCOS). After departure, the aircraft climbs to 12,000 ft and airway V4 is intercepted, following ATC vectors.

Airway V4 is flown to Salina VOR (SLN) using VOR navigation, then airway V244 is flown using GPS Navigation. The ILS approach for runway 35L and LPV (WAAS) approach for runway 35R are shown and a missed approach is executed.

- SYSTEM OVERVIEW
- FLIGHT INSTRUMENTS
- EIS
- AUDIO PANEL & CNS
- FLIGHT MANAGEMENT
- HAZARD AVOIDANCE
- AFCS
- ADDITIONAL FEATURES
- APPENDICES
- INDEX

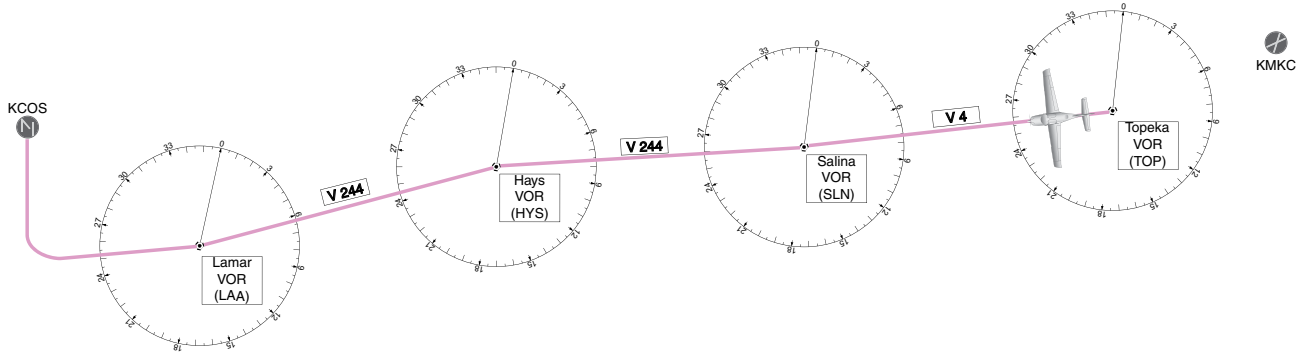

Figure 7-31 Flight Plan Overview

DEPARTURE

Climbing to the Selected Altitude and flying an assigned heading:

- 1) Before takeoff:
 - a) Use the **ALT SEL** Knob to set the Selected Altitude to 12,000 feet.
 - b) Push the GA Switch to activate Takeoff Mode. The flight director Command Bars establish a pitch up attitude to follow.



- c) Press the **AP** Key to engage the autopilot in a climb, holding the pitch angle commanded in Takeoff Mode and wings level.



2) In this example, Vertical Speed Mode is used to capture the Selected Altitude (Pitch Hold, Vertical Speed, or Indicated Airspeed Mode may be used).

a) Press the **VS** Key to activate Vertical Speed Mode.

The Vertical Speed Reference may be adjusted after Vertical Speed Mode is selected using the **NOSE UP/DN** Wheel.

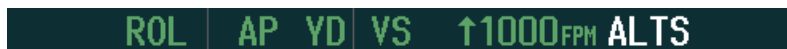

3) Use the **HDG** Knob to set the Selected Heading, complying with ATC vectors to intercept Airway V4.

Press the **HDG** Key to activate Heading Select Mode while the autopilot is engaged in the climb. The autopilot follows the Selected Heading Bug on the HSI and turns the aircraft to the desired heading.

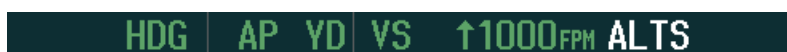

4) As the aircraft nears the Selected Altitude, the flight director transitions to Selected Altitude Capture Mode, indicated by the green 'ALTS' annunciation flashing for up to 10 seconds.



At 50 feet from the Selected Altitude, the green 'ALT' annunciation flashes for up to 10 seconds; the autopilot transitions to Altitude Hold Mode and levels the aircraft.

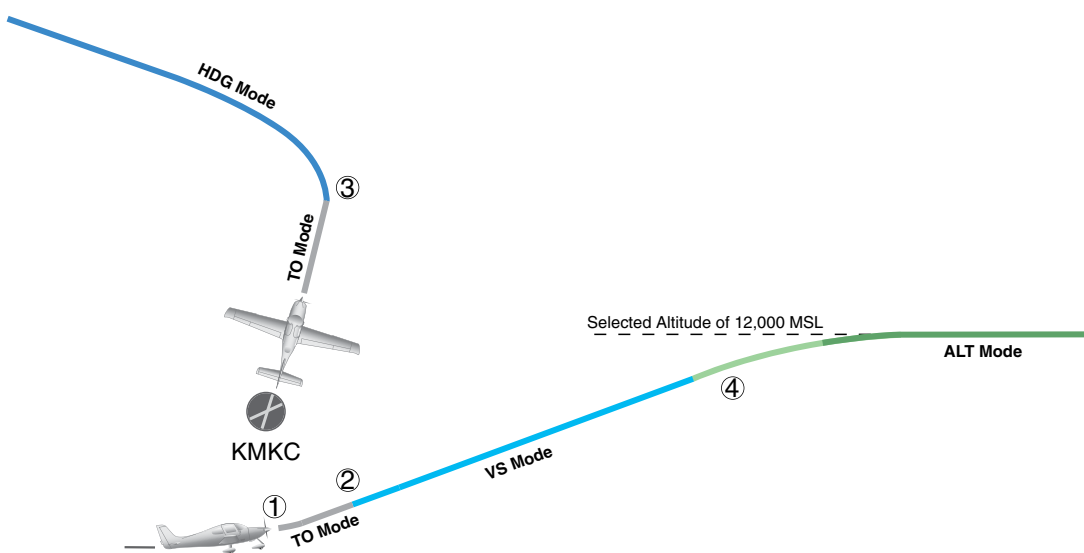

Figure 7-32 Departure

INTERCEPTING A VOR RADIAL

During climb-out, the autopilot continues to fly the aircraft in Heading Select Mode. Airway V4 to Salina VOR (SLN) should now be intercepted. Since the enroute flight plan waypoints correspond to VORs, flight director Navigation Mode using either VOR or GPS as the navigation source may be used. In this scenario, VOR Navigation Mode is used for navigation to the first VOR waypoint in the flight plan.

Intercepting a VOR radial:

- 1) Arm VOR Navigation Mode:
 - a) Tune the VOR frequency.
 - b) Press the **CDI** Softkey to set the navigation source to VOR.
 - c) Use the **CRS** Knob to set the Selected Course to the desired value, 255°. Note that at this point, the flight director is still in Heading Select Mode and the autopilot continues to fly the Selected Heading, 290°.
 - d) Press the **NAV** Key. This arms VOR Navigation Mode and the white 'VOR' annunciation appears to the left of the active lateral mode.



- 2) As the aircraft nears the Selected Course, the flight director transitions from Heading Select to VOR Navigation Mode and the 'VOR' annunciation flashes green. The autopilot begins turning to intercept the Selected Course.



- 3) The autopilot continues the turn until the aircraft is established on the Selected Course.

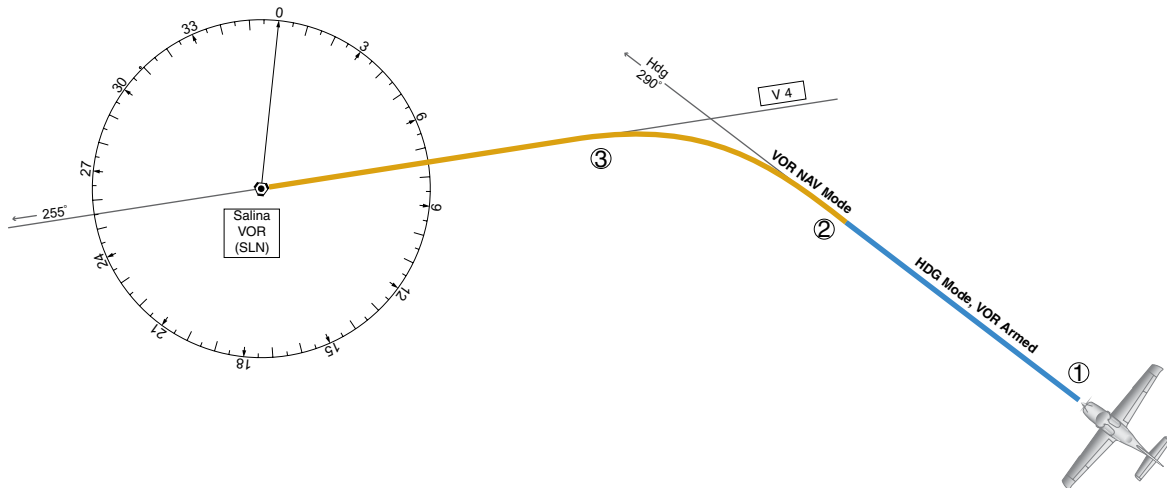

Figure 7-33 Intercepting a VOR Radial

FLYING A FLIGHT PLAN/GPS COURSE



NOTE: Changing the navigation source cancels Navigation Mode and causes the flight director to revert back to Roll Hold Mode (wings rolled level).

As the aircraft closes on Salina VOR, GPS is used to navigate the next leg, airway V244. The aircraft is currently tracking inbound on Airway V4.

Flying a GPS flight plan:

- 1) Transition from VOR to GPS Navigation Mode:
 - a) Press the **CDI** Softkey until GPS is the selected navigation source.
 - b) Press the **NAV** Key to activate GPS Navigation Mode. The autopilot guides the aircraft along the active flight plan leg.



- 2) Following the flight plan, the autopilot continues to steer the aircraft under GPS guidance. Note that in GPS Navigation Mode, course changes defined by the flight plan are automatically made without pilot action required.

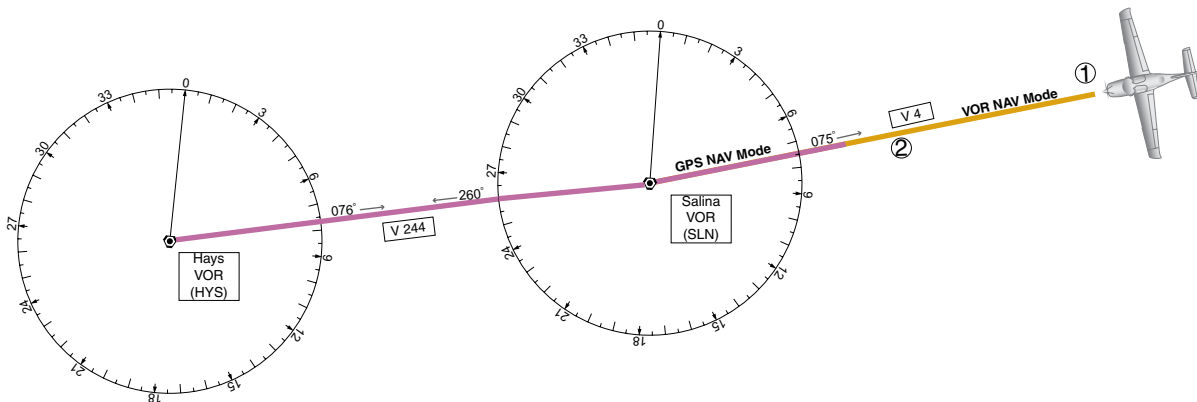

Figure 7-34 Transition to GPS Flight Plan

DESCENT

While flying the arrival procedure, the aircraft is cleared for descent in preparation for the approach to KCOS. Three methods are presented for descent:

- Indicated Airspeed descent – Indicated Airspeed Mode can be used to descend to the Selected Altitude at a constant airspeed. This descent method does not account for flight plan waypoint altitude constraints.
- Vertical Path Tracking descent – Vertical Path Tracking Mode is used to follow the vertical descent path defined in the GPS flight plan. Altitude constraints correspond to waypoints in the flight plan. Before VNV flight control can provide vertical profile guidance, a VNV flight plan must be entered and enabled.
- Non-path descent in a VNV scenario – A VNV flight plan is entered and enabled, however Pitch Hold, Vertical Speed, or Indicated Airspeed Mode can be used to descend to the VNV Target Altitude prior to reaching the planned TOD. Indicated Airspeed Mode is used in the example.

Indicated Airspeed descent:

- 1) Select Indicated Airspeed Mode:
 - a) Using the **ALT SEL** Knob, set the Selected Altitude to 10,000 feet.
 - b) Press the **IAS** Key to activate Indicated Airspeed Mode. The annunciation 'IAS' appears next to the Airspeed Reference, which defaults to the current aircraft airspeed. Selected Altitude Capture Mode is armed automatically.

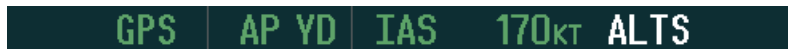

- 2) Use the **NOSE UP/DN** Wheel to adjust the commanded airspeed while maintaining the same power, or reduce power to allow descent in Indicated Airspeed Mode while the autopilot maintains the current airspeed.
- 3) As the aircraft nears the Selected Altitude, the flight director transitions to Selected Altitude Capture Mode, indicated by the green 'ALTS' annunciation flashing for up to 10 seconds.



The green 'ALT' annunciation flashes for up to 10 seconds upon reaching 50 feet from the Selected Altitude; the autopilot transitions to Altitude Hold Mode and levels the aircraft.

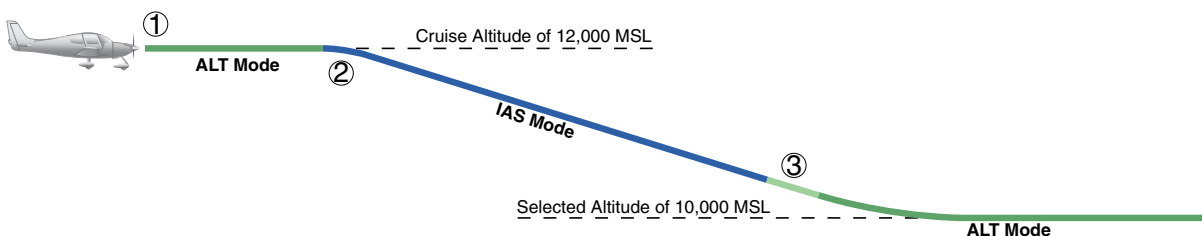

Figure 7-35 IAS Descent

Vertical Path Tracking descent to VNV Target Altitude:

- 1) Select VNV mode:
 - a) Press the **VNV** Key to arm Vertical Path Tracking Mode. The white annunciation 'VPTH' appears.

GPS | AP YD | ALT 12000FT VPTH

- b) Using the **ALT SEL** Knob, set the Selected Altitude below the flight plan's VNV Target Altitude of 10,000 feet.

If the Selected Altitude is not at least 75 ft below the VNV Target Altitude, the flight director captures the Selected Altitude rather than the VNV Target Altitude once Vertical Path Tracking Mode becomes active (ALTS is armed rather than ALTV).

- c) If Vertical Path Tracking Mode is armed more than 5 minutes prior to descent path capture, acknowledgment is required for the flight director to transition from Altitude Hold to Vertical Path Tracking Mode. To proceed with descent path capture if the white 'VPTH' annunciation begins flashing, do one of the following:
 - Press the **VNV** Key.
 - Turn the **ALT SEL** Knob to adjust the Selected Altitude.

If the descent is not confirmed by the time of interception, Vertical Path Tracking Mode remains armed and the descent is not captured.

- 2) When the top of descent (TOD) is reached, the flight director transitions to Vertical Path Tracking Mode and begins the descent to the VNV Target Altitude. Intention to capture the VNV Target Altitude is indicated by the white 'ALTV' annunciation.

GPS | AP YD | VPTH | ALTV

- 3) As the aircraft nears the VNV Target Altitude, the flight director transitions to VNV Target Altitude Capture Mode, indicated by the green 'ALTV' annunciation flashing for up to 10 seconds.

GPS | AP YD | ALTV10000FT | ALT

The green 'ALT' annunciation flashes for up to 10 seconds upon reaching 50 feet from the VNV Target Altitude; the autopilot transitions to Altitude Hold Mode and levels the aircraft at the vertical waypoint.

GPS | AP YD | ALT 10000FT

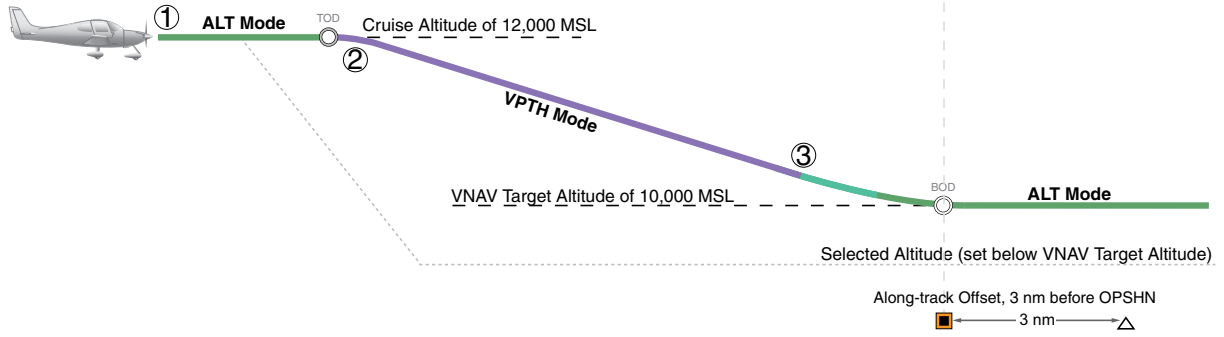

Figure 7-36 VPTH Descent

Non-path descent using Indicated Airspeed Mode:

- 1) Using Indicated Airspeed Mode, command a non-path descent to an intermediate altitude above the next VNV flight plan altitude.
 - a) Using the **ALT SEL** Knob, set the Selected Altitude below the current aircraft altitude to an altitude (in this case, 9,400 feet) at which to level off between VNV flight plan altitudes.
 - b) Press the **IAS** Key before the planned TOD during an altitude hold while VPTH is armed. The Airspeed Reference defaults to the current aircraft airspeed. Vertical Path Tracking and Selected Altitude Capture Mode are armed automatically.

GPS | AP YD | IAS | 170KT | **ALTS** | VPTH

- 2) Reduce power to allow descent in Indicated Airspeed Mode. The autopilot maintains the Airspeed Reference.
- 3) As the aircraft nears the Selected Altitude, the flight director transitions to Selected Altitude Capture Mode, indicated by the green 'ALTS' annunciation flashing for up to 10 seconds.

GPS | AP YD | **ALTS** | 9400FT | ALT | VPTH

The green 'ALT' annunciation flashes for up to 10 seconds upon reaching 50 feet from the Selected Altitude; the autopilot transitions to Altitude Hold Mode and levels the aircraft. After leveling off reset Selected Altitude at or below 9,000 ft.

GPS | AP YD | **ALT** | 9400FT | VPTH

- 4) When the next TOD is reached, Vertical Path Tracking becomes active (may require acknowledgment to allow descent path capture).

GPS | AP YD | VPTH | **ALTV**

- 5) As the aircraft nears the VNV Target Altitude, the flight director transitions to VNV Target Altitude Capture Mode, indicated by the green 'ALTV' annunciation flashing for up to 10 seconds.

GPS | AP YD | **ALTV** | 9000FT | ALT

The green 'ALT' annunciation flashes for up to 10 seconds upon reaching 50 feet from the VNV Target Altitude; the autopilot transitions to Altitude Hold Mode and levels the aircraft at the vertical waypoint.

GPS | AP YD | **ALT** | 9000FT

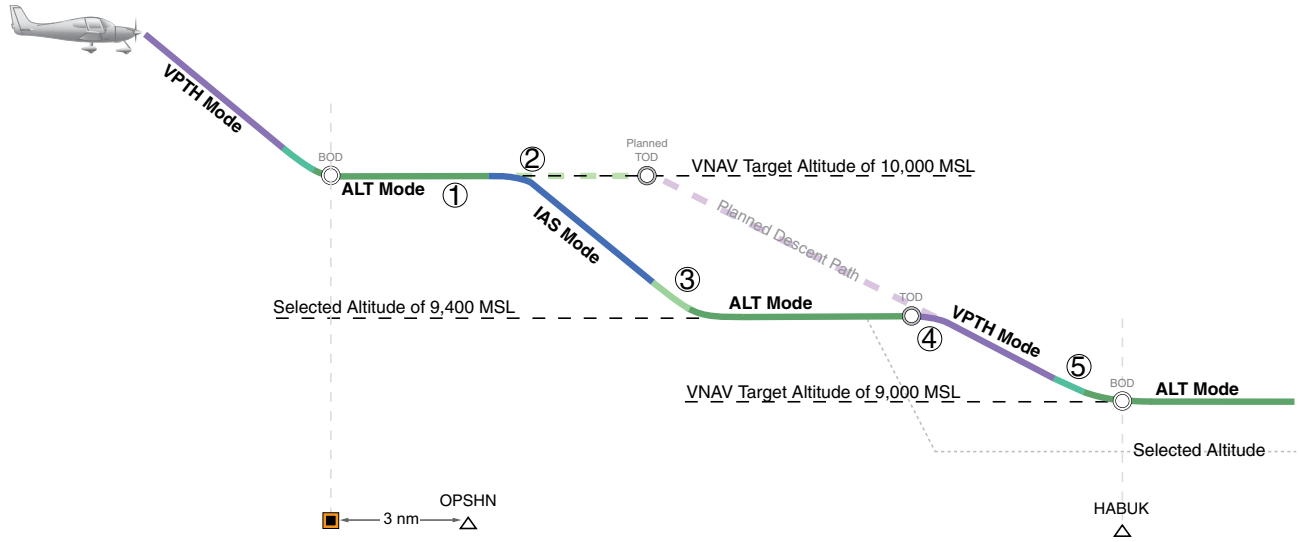

Figure 7-37 Non-path Descent

APPROACH



NOTE: If an approach contains a DME arc, the arc must be flown in Navigation Mode with the AFCS. When receiving vectors from ATC, Navigation Mode must be selected prior to intercepting the ARC.

Flying an ILS approach:

- 1) Transition from GPS Navigation Mode to Heading Select Mode.
 - a) Select the Runway 35L ILS approach for KCOS and select 'VECTORS' for the transition. Load and activate the approach into the flight plan.
 - b) Use the **HDG** Knob to set the Selected Heading after getting vectors from ATC.
 - c) Press the **HDG** Key. The autopilot turns the aircraft to the desired heading.
 - d) Use Heading Select Mode to comply with ATC vectors as requested.



- 2) Arm LOC Approach and Glideslope modes.
 - a) Ensure the appropriate localizer frequency is tuned.
 - b) Press the **APR** Key when cleared for approach to arm Approach and Glideslope modes. 'LOC' and 'GS' appear in white as armed mode annunciations.



- c) The navigation source automatically switches to LOC. After this switch occurs, the localizer signal can be captured and the flight director determines when to begin the turn to intercept the final approach course. The flight director now provides guidance to the missed approach point.

- 3) There are two options available at this point, as the autopilot flies the ILS approach:
 - Push the **AP DISC** Button at the decision height and land the aircraft.
 - Use the **GA** Button to execute a missed approach.

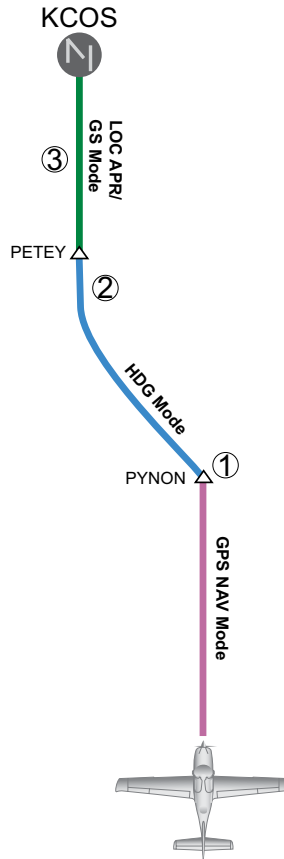

Figure 7-38 ILS Approach to KCOS

Flying a RNAV GPS approach with vertical guidance (SBAS Only):

- 1) Arm flight director modes for a RNAV GPS approach with vertical guidance:
 - a) Make sure the navigation source is set to GPS (use CDI Softkey to change navigation source).
 - b) Select the Runway 35R LPV approach for KCOS. Load and activate the approach into the flight plan.
- 2) Press the **APR** Key once clearance for approach has been received. GPS Approach Mode is activated and Glidepath Mode is armed.

GPS | AP YD | VPTH | ALTS GP

- 3) Once the glidepath is captured, Glidepath Mode becomes active. The flight director now provides guidance to the missed approach point.

GPS | AP YD | GP

- SYSTEM OVERVIEW
- FLIGHT INSTRUMENTS
- EIS
- AUDIO PANEL & CNS
- FLIGHT MANAGEMENT
- HAZARD AVOIDANCE
- AFCS
- ADDITIONAL FEATURES
- APPENDICES
- INDEX

- 4) There are two options available at this point, as the autopilot flies the approach:
- Push the **AP DISC** Button at the decision height and land the aircraft.
 - Use the **GA** Button to execute a missed approach.

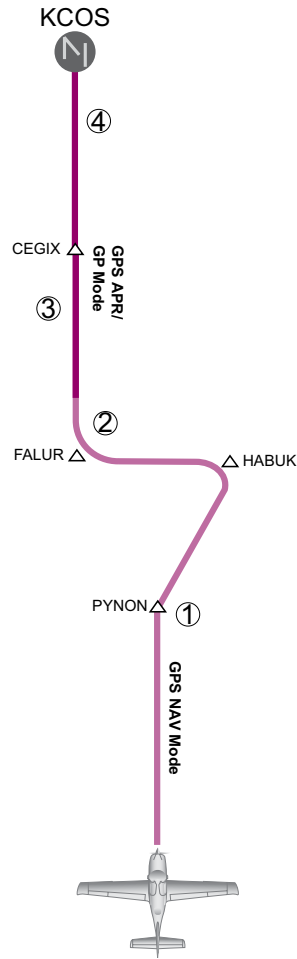

Figure 7-39 LPV Approach to KCOS

GO AROUND/MISSED APPROACH



NOTE: As a result of calculations performed by the system while flying the holding pattern, the display may re-size automatically and the aircraft may not precisely track the holding pattern as depicted on the PFD and MFD.

Flying a missed approach:

- 1) Push the **GA** Button at the Decision height and apply go-around power to execute a missed approach. The flight director Command Bars establish a nose-up climb to follow. If flying an ILS or LOC approach the CDI also switches to GPS as the navigation source.

GA	AP YD	GA	ALTS
----	-------	----	------

- 2) Start the climb to the prescribed altitude in the published Missed Approach Procedure (in this case, 10,000 ft). Press the **NAV** Key to have the autopilot fly to the hold.

GPS	AP YD	PIT	ALTS
-----	-------	-----	------

- 3) Use the **ALT SEL** Knob to set a Selected Altitude to hold. To hold the current airspeed during the climb, press the **IAS** Key.

GPS	AP YD	IAS	120KT	ALTS
-----	-------	-----	-------	------

As the aircraft nears the Selected Altitude, the flight director transitions to Selected Altitude Capture Mode, indicated by the green 'ALTS' annunciation flashing for up to 10 seconds.

GPS	AP YD	ALTS 10000FT	ALT
-----	-------	--------------	-----

The green 'ALT' annunciation flashes for up to 10 seconds upon reaching 50 feet from the Selected Altitude; the autopilot transitions to Altitude Hold Mode and levels the aircraft.

GPS	AP YD	ALT 10000FT
-----	-------	-------------

- 4) The autopilot flies the holding pattern after the missed approach is activated. Annunciations are displayed in the Navigation Status Box, above the AFCS Status Box.

6.0NM	MOGAL	DIS 2.2NM	ETE 09:27
GPS	AP YD	ALT 10000FT	

SYSTEM OVERVIEW
FLIGHT INSTRUMENTS
EIS
AUDIO PANEL & CNS
FLIGHT MANAGEMENT
HAZARD AVOIDANCE
AFCS
ADDITIONAL FEATURES
APPENDICES
INDEX

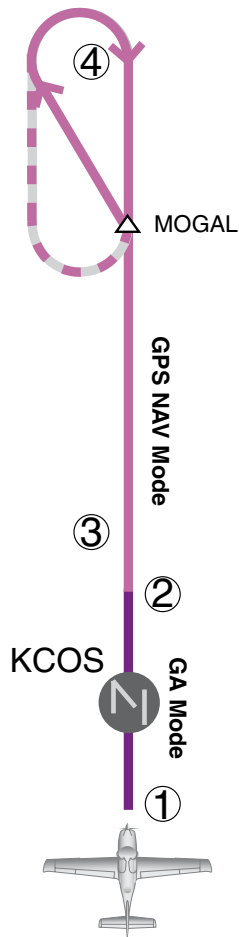

Figure 7-40 Go Around/Missed Approach

AFCS ANNUNCIATIONS AND ALERTS

AFCS STATUS ALERTS

The annunciations in Table 7-5 (listed in order of increasing priority) can appear on the PFD above the Airspeed and Attitude indicators. Only one annunciation may occur at a time, and messages are prioritized by criticality.



Figure 7-41 AFCS Status Annunciation

Alert Condition	Annunciation	Description
Rudder Mistrim Right	RUD→	Yaw servo providing sustained force in the indicated direction
Rudder Mistrim Left	←RUD	
Aileron Mistrim Right	AIL→	Roll servo providing sustained force in the indicated direction
Aileron Mistrim Left	←AIL	
Elevator Mistrim Down	↓ELE	Pitch servo providing sustained force in the indicated direction
Elevator Mistrim Up	↑ELE	
Pitch Trim Failure	PTRM	If AP engaged, take control of the aircraft and disengage AP If AP disengaged, move MET switch to unstick
Yaw Damper Failure	YAW	YD control failure
Roll Failure	ROLL	Roll axis control failure; AP inoperative
Pitch Failure	PTCH	Pitch axis control failure
System Failure	AFCS	AP and MET are unavailable; FD may still be available
Preflight Test	PFT	Performing preflight system test. Do not press the AP DISC Button during servo power-up and preflight system tests as this may cause the preflight system test to fail or never to start (if servos fail their power-up tests). Power must be cycled to the servos to remedy the situation.
	PFT	Preflight system test failed; aural alert sounds at failure
Hypoxia Recognition System is activated	EDM	Activated only by the Hypoxia Recognition System

Table 7-5 AFCS Status Alerts

OVERSPEED PROTECTION

NOTE: Overspeed protection is not active in ALT, GS or GP Modes.

While Pitch Hold, Vertical Speed, Indicated Airspeed, Vertical Path Tracking, or an altitude capture mode is active, airspeed is monitored by the flight director. Pitch commands are not changed until overspeed protection becomes active. Overspeed protection is provided in situations where the flight director cannot acquire and maintain the mode reference for the selected vertical mode without exceeding the certified maximum autopilot airspeed.

When an autopilot overspeed condition occurs, the Airspeed Reference appears in a box above the Airspeed Indicator, flashing a yellow ‘MAXSPD’ annunciation. The autopilot, if engaged, will follow the pitch up command from the flight director. Engine power should be reduced and/or the pitch reference adjusted to slow the aircraft. The annunciation disappears when the overspeed condition is resolved.

NOTE: When the autopilot is outside normal operating limits, it uses more aggressive commands to return to normal limits.

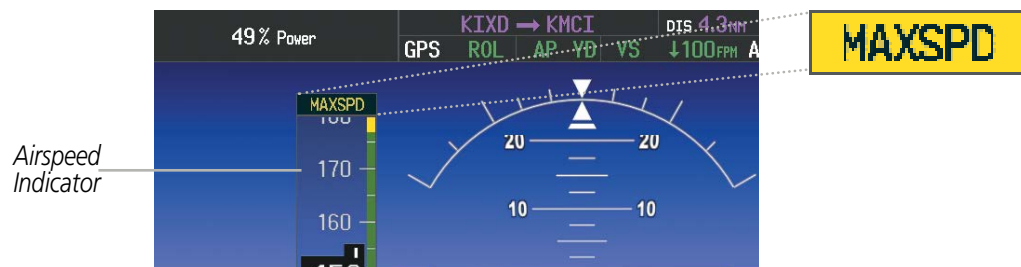

Figure 7-42 Overspeed Annunciation

UNDERSPEED PROTECTION

NOTE: While underspeed protection is active, the aircraft will deviate from the selected reference.

Underspeed Protection is designed to discourage aircraft operation below minimum established airspeeds and is available when the autopilot is on.

When the aircraft reaches a predetermined airspeed (Table 7-6), a yellow MINSPD annunciation (Figure 7-43) will appear above the airspeed indicator. When the airspeed trend vector reaches a predetermined airspeed (Table 7-6), a single aural “AIRSPEED” will sound, alerting the pilot to the impending underspeed condition.

TKS FIKI *	Flaps	MINSPD Annunciation	Aural AIRSPEED Alert
OFF	0%	80 kt	85 kt
	50%	76 kt	80 kt
	100%	70 kt	80 kt
ON	0%	85 kt	90 kt
	50%	81 kt	85 kt

* The optional TKS Flight Into Known Icing (FIKI) Anti-Ice System is only available on SR22 Models

Table 7-6 MINSPD Annunciation and AIRSPEED Alert

- SYSTEM OVERVIEW
- FLIGHT INSTRUMENTS
- EIS
- AUDIO PANEL & CNS
- FLIGHT MANAGEMENT
- HAZARD AVOIDANCE
- AFCS
- ADDITIONAL FEATURES
- APPENDICES
- INDEX

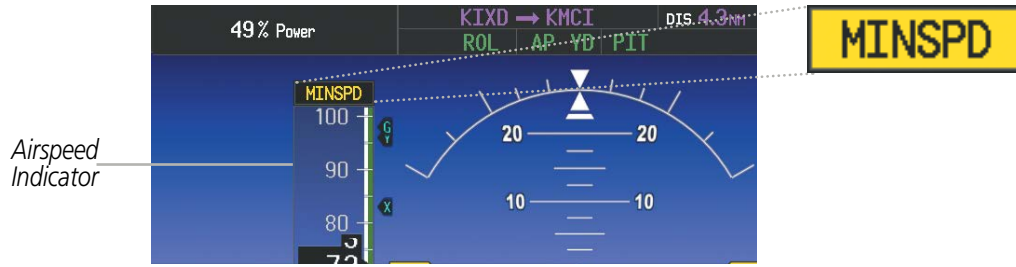

Figure 7-43 MINSPD Annunciation

If the aircraft continues to decelerate, Underspeed Protection functionality depends on which vertical flight director mode is selected. For the purpose of this discussion, the vertical flight director modes can be divided into two categories: Those in which it is important to maintain altitude for as long as possible (altitude-critical modes), and those in which maintaining altitude is less crucial (non-altitude critical modes).

ALTITUDE-CRITICAL MODES (ALT, GS, GP, TO, GA)

If the aircraft decelerates to stall warning for at least one second, the lateral and vertical flight director modes will change from active to armed (Figure 7-44). The autopilot will provide input causing the aircraft to pitch down to maintain an airspeed no less than stall warning activation speed plus two knots, and the wings to level.

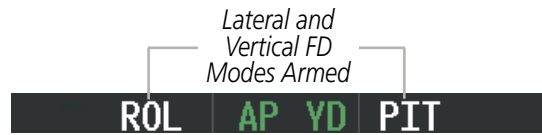

Figure 7-44 Lateral and Vertical Flight Director Modes Armed

An aural “AIRSPEED” alert will sound every five seconds and a red “UNDERSPEED PROTECT ACTIVE” annunciation (Figure 7-45) will appear in the CAS window.

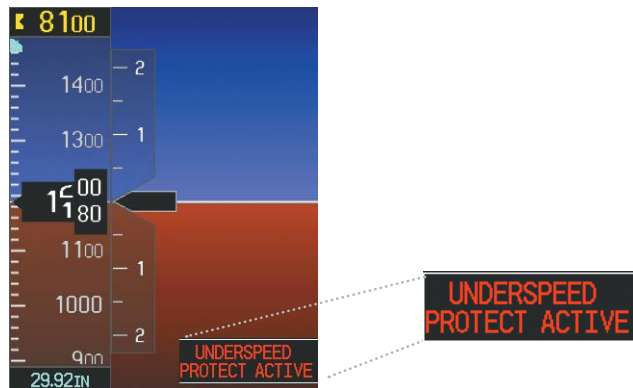

Figure 7-45 Underspeed Protect Active Annunciation

When airspeed increases (as a result of adding power/thrust) to above the IAS at which stall warning turns off, plus two knots, the autopilot will cause the aircraft to pitch up until recapturing the vertical reference. The vertical and lateral flight director modes will change from armed to active.

NON-ALTITUDE CRITICAL MODES (VS, VNAV, LVL, PIT, IAS)

If the aircraft decelerates to an IAS below the minimum commandable autopilot airspeed, a red “UNDERSPEED PROTECT ACTIVE” annunciation (Figure 7-45) will appear in the CAS window. The vertical flight director mode will change from active to armed (Figure 7-46), and the autopilot will cause the aircraft to pitch down until reaching a pitch attitude at which IAS equals the minimum commandable autopilot airspeed.



Figure 7-46 Vertical Flight Director Mode Armed

When sufficient power/thrust is available, the autopilot will recapture the previously selected vertical reference and the flight director mode will change from armed to active.



NOTE: When the autopilot is outside normal operating limits, it uses more aggressive commands to return to normal limits.

7.2 S-TEC FIFTY FIVE X AUTOPILOT (OPTIONAL)



NOTE: This section covers only the additional 'AP' (autopilot engaged) status annunciation that may appear in the Perspective AFCS Status Box. This status annunciation is not analogous to both the Perspective and the S-TEC Fifty Five X. Refer to the approved S-TEC Fifty Five X Pilot's Operating Handbook (POH) for comprehensive list of annunciations and operating instructions.

In addition to the status and mode annunciations that are simultaneously displayed on both the Perspective (AFCS Status Box) and the S-TEC Fifty Five X (Autopilot Display and/or Remote Annunciator Display), the Perspective displays an additional status annunciation of 'AP' when the autopilot is engaged.

Autopilot
Status



Figure 7-47 Autopilot Engaged (Perspective™ AFCS Status Box)

SECTION 8 ADDITIONAL FEATURES



NOTE: With the availability of SafeTaxi®, ChartView, or FliteCharts®, it may be necessary to carry another source of charts on-board the aircraft.

Additional features of the system include the following:

- Synthetic Vision Technology (SVT™)
- Auxillary Video & Enhanced Vision System (EVS)
- SafeTaxi® diagrams
- ChartView and FliteCharts® electronic charts
- AOPA or AC-U-KWIK Airport Directory
- SiriusXM Satellite Radio entertainment
- Satellite telephone and SMS messaging services
- Data Link (Wi-Fi)
- Scheduler
- Electronic Checklists
- Flight Data Logging
- Hypoxia Recognition System
- Electronic Stability and Protection (ESP™) System
- Position Reporting
- Bluetooth® Management using a Flight Stream 210 (Optional)

The optional Synthetic Vision Technology (SVT™) provides a three-dimensional forward view of terrain features on the PFD. SVT imagery shows the pilot's view of relevant features in relation to the aircraft attitude, as well as the flight path pertaining to the active flight plan.

The Perspective® system provides a control and display interface to an Enhanced Vision System to aid situational awareness. An option is also available to display a second video source.

SafeTaxi diagrams provide detailed taxiway, runway, and ramp information at more than 700 airports in the United States. By decreasing range on an airport that has a SafeTaxi diagram available, a close up view of the airport layout can be seen.

The optional ChartView and FliteCharts provide on-board electronic terminal procedures charts. Electronic charts offer the convenience of rapid access to essential information. Either ChartView or FliteCharts may be configured in the system, but not both.

The AOPA and AC-U-KWIK Airport Directories offer detailed information for a selected airport, such as available services, hours of operation, and lodging options.

The optional SiriusXM Satellite Radio entertainment audio feature of the GDL 69A Data Link Receiver handles more than 170 channels of music, news, and sports. SiriusXM Satellite Radio offers more entertainment choices and longer range coverage than commercial broadcast stations.

Telephone and Data Link Services are optional subscription services offered through Garmin Flight Data Services and Iridium Satellite LLC. Voice and SMS messaging communications are through the Iridium Satellite Network. Data communications are through Iridium Data Services, or a wireless network (Wi-Fi) when the aircraft is on the ground.

The Scheduler feature can be used to enter and display short term or long term reminder messages such as Switch fuel tanks, Change oil, or Altimeter-Transponder Check in the Messages Window on the PFD.

Optional checklists help to quickly find the proper procedure on the ground or during flight.

The Flight Data Logging feature automatically stores critical flight and engine data on an SD data card. Approximately 1,000 flight hours can be recorded for each 1GB of available space on the card.

The optional Hypoxia Recognition System provides protection to aircraft occupants from succumbing to the debilitating affects of hypoxia.

The optional Garmin Electronic Stability and Protection (ESP™) system discourages aircraft operation outside the normal flight envelope.

The Position Reporting feature allows the system to send position reporting information to a provider, such as FlightAware.com.

The optional Flight Stream 210 device provides a Bluetooth® connection with a mobile device running Garmin Pilot™ or other compatible application. GPS and AHRS data can then be shared with the mobile device. Also, flight plans can be transferred from the mobile device to the Perspective® system.

8.1 SYNTHETIC VISION TECHNOLOGY (SVT)



WARNING: Use appropriate primary systems for navigation, and for terrain, obstacle, and traffic avoidance. SVT is intended as an aid to situational awareness only and may not provide either the accuracy or reliability upon which to solely base decisions and/or plan maneuvers to avoid terrain, obstacles, or traffic.

The optional Synthetic Vision Technology (SVT) is a visual enhancement to the Perspective® Integrated Avionics System. SVT depicts a forward-looking attitude display of the topography immediately in front of the aircraft. The field of view is 30 degrees to the left and 35 degrees to the right. SVT information is shown on the Primary Flight Display (PFD), or on the Multifunction Display (MFD) in Reversionary Mode. The depicted imagery is derived from the aircraft attitude, heading, GPS three-dimensional position, and a nine arc-second database of terrain, obstacles, and other relevant features. The terrain data resolution of nine arc-seconds, meaning the terrain elevation contours are stored in squares measuring nine arc-seconds on each side, is required for the operation of SVT. Loss of any of the required data, including temporary loss of the GPS signal, will cause SVT to be disabled until the required data is restored.

The SVT terrain display shows land contours (colors are consistent with those of the topographical map display), large water features, towers, and other obstacles over 200' AGL that are included in the obstacle database. Cultural features on the ground such as roads, highways, railroad tracks, cities, and state boundaries are not displayed even if those features are found on the MFD map. The terrain display also includes a north–south east–west grid with lines oriented with true north and spaced at one arc-minute intervals to assist in orientation relative to the terrain.

The optional Terrain Awareness and Warning System (TAWS-B) or standard Terrain-SVT is integrated within SVT to provide visual and auditory alerts to indicate the presence of terrain and obstacle threats relevant to the projected flight path. Terrain alerts are displayed in red and yellow shading on the PFD.

The terrain display is intended for situational awareness only. It may not provide the accuracy or fidelity on which to base decisions and plan maneuvers to avoid terrain or obstacles. Navigation must not be predicated solely upon the use of the Terrain–SVT or TAWS-B terrain or obstacle data displayed by the SVT.

The following SVT enhancements appear on the PFD:

- Pathways
- Flight Path Marker
- Horizon Heading Marks
- Traffic Display
- Airport Signs
- Runway Display
- Terrain Alerting
- Obstacle Alerting



Figure 8-1 Synthetic Vision Imagery

SVT OPERATION

SVT is activated from the PFD using the softkeys located along the bottom edge of the display. Pressing the softkeys turns the related function on or off. When SVT is enabled, the pitch scale increments are reduced to 10 degrees up and 7.5 degrees down.

SVT functions are displayed on three levels of softkeys. The **PFD** Softkey leads into the PFD function Softkeys, including synthetic vision. Pressing the **SYN VIS** Softkey displays the SVT feature softkeys. The softkeys are labeled **PATHWAY**, **SYN TERR**, and **APTSIGNS**. The **HRZN HDG** displays the Horizon Heading indications and is available independent of the other SVT functions. When Horizon Heading is enabled, the Flight Path Marker may also be enabled independent of SVT by means of the **FPM** Softkey. The **BACK** Softkey returns to the previous level of softkeys.

APTSIGNS, and **PATHWAY** Softkeys are only available when the **SYN TERR** Softkey is enabled (gray with black characters). After enabling the **SYN TERR** Softkey, the **APTSIGNS**, and **PATHWAY** softkeys may be enabled in any combination to display desired features. When system power is cycled, the last selected state (on or off) of the **SYN TERR**, **HRZN HDG**, **APTSIGNS**, **PATHWAY**, and **FPM** softkeys is remembered by the system.

- **PATHWAY** Softkey enables display of rectangular boxes that represent course guidance.
- **SYN TERR** Softkey enables synthetic terrain depiction.
- **HRZN HDG** Softkey enables horizon heading marks and digits on the Zero Pitch Line.
- **APTSIGNS** Softkey enables airport signposts.
- **FPM** Softkey enables the Flight Path Marker when SVT is not enabled (**HRZN HDG** must be enabled).

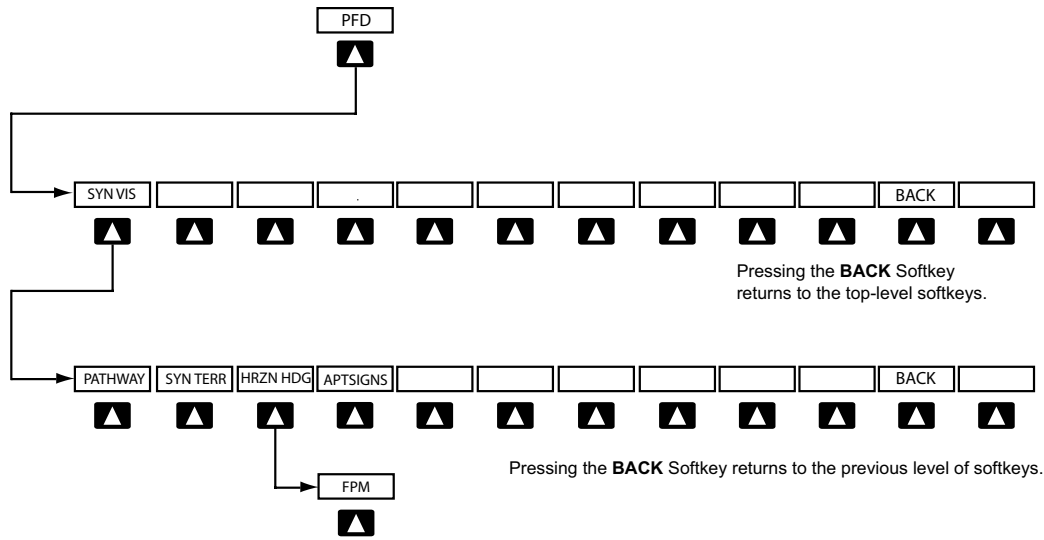

Figure 8-2 SVT Softkeys

Enabling/disabling SVT:

- 1) Press the **PFD** Softkey.
- 2) Press the **SYN VIS** Softkey.
- 3) Press the **SYN TERR** Softkey. The SVT display will cycle on or off with the **SYN TERR** Softkey.

Enabling/disabling Pathways:

- 1) Press the **PFD** Softkey.
- 2) Press the **SYN VIS** Softkey.
- 3) Press the **PATHWAY** Softkey. The Pathways feature will cycle on or off with the **PATHWAY** Softkey.

Enabling/disabling Horizon Heading:

- 1) Press the **PFD** Softkey.
- 2) Press the **SYN VIS** Softkey.
- 3) Press the **HRZN HDG** Softkey. The horizon heading display will cycle on or off with the **HRZN HDG** Softkey.

Enabling/disabling Airport Signs:

- 1) Press the **PFD** Softkey.
- 2) Press the **SYN VIS** Softkey.
- 3) Press the **APTSIGNS** Softkey. Display of airport signs will cycle on or off with the **APTSIGNS** Softkey.

Enabling/disabling the Flight Path Marker:

- 1) Press the **PFD** Softkey.
- 2) Press the **SYN VIS** Softkey.
- 3) Press the **FPM** Softkey. The Flight Path Marker display will cycle on or off with the **FPM** Softkey.

SVT FEATURES



Figure 8-3 SVT on the Primary Flight Display



NOTE: Pathways and terrain features are not a substitute for standard course and altitude deviation information provided by the altimeter, CDI, and VDI.

PATHWAYS

Pathways provide a three-dimensional perspective view of the selected route of flight shown as colored rectangular boxes representing the horizontal and vertical flight path of the active flight plan. The box size represents 700 feet wide by 200 feet tall during enroute, oceanic, and terminal flight phases. During an approach, the box width is 700 feet or one half full scale deviation on the HSI, whichever is less. The height is 200 feet or one half full scale deviation on the VDI, whichever is less. The altitude at which the pathway boxes are displayed is determined by the selected altitude during climb, cruise, and when the active leg is the final approach course prior to intercepting the glidepath/glideslope. During a descent (except while on the approach glidepath/glideslope), the pathway boxes are displayed at the selected altitude, or the VNAV altitude programmed for the active leg in the flight plan, or the published altitude constraint, whichever is higher (Figure 8-4). Just prior to intercepting the glidepath/glideslope, the pathway boxes are displayed on the glidepath/glideslope, or the selected altitude, whichever is lower.

The color of the rectangular boxes may be magenta, green, or white depending on the route of flight and navigation source selected. The active GPS or GPS overlay flight plan leg is represented by magenta boxes that correspond to the Magenta CDI. A localizer course is represented by green boxes that correspond to a green CDI. An inactive leg of an active flight plan is represented by white boxes corresponding to a white line drawn on the Inset map or MFD map indicating an inactive leg.

- SYSTEM OVERVIEW
- FLIGHT INSTRUMENTS
- EIS
- AUDIO PANEL & CNS
- FLIGHT MANAGEMENT
- HAZARD AVOIDANCE
- AFCS
- ADDITIONAL FEATURES
- APPENDICES
- INDEX

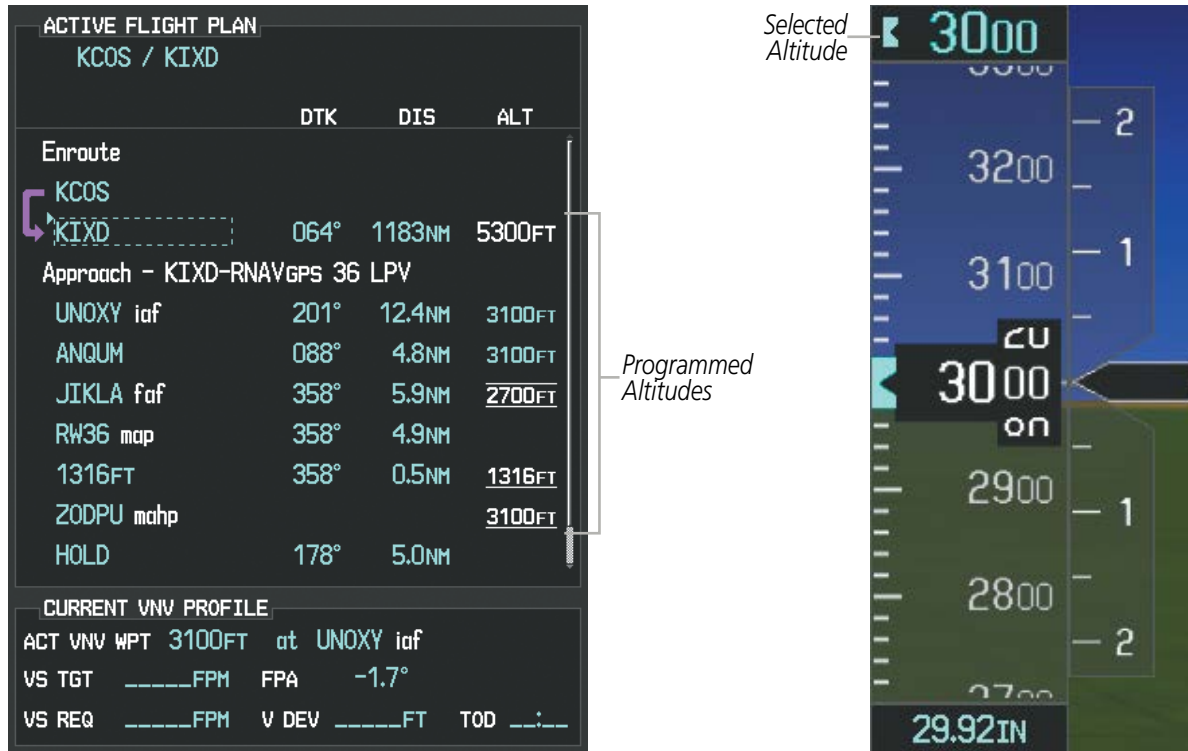

Figure 8-4 Programmed and Selected Altitude

Pathways provide supplemental glidepath/glideslope information on an active ILS, LPV, LNAV/VNAV, LP, and some LNAV approaches. Pathways are intended as an aid to situational awareness and should not be used independent of the CDI, VDI, glide path indicator, and glide slope indicator. They are removed from the display when the selected navigation information is not available. Pathways are not displayed beyond the active leg when leg sequencing is suspended and are not displayed on any portion of the flight plan leg that would lead to intercepting a leg in the wrong direction.

DEPARTURE AND ENROUTE

Prior to intercepting an active flight plan leg, pathways are displayed as a series of boxes with pointers at each corner that point in the direction of the active waypoint. Pathways are not displayed for the first leg of the flight plan if that segment is a Heading-to-Altitude leg. The first segment displaying pathways is the first active GPS leg or active leg with a GPS overlay. If this leg of the flight plan route is outside the SVT field of view, pathways will not be visible until the aircraft has turned toward this leg. While approaching the center of the active leg and prescribed altitude, the number of pathway boxes decreases to a minimum of four.

Climb profiles cannot be displayed due to the variables associated with aircraft performance. Flight plan legs requiring a climb are indicated by pathways displayed at a level above the aircraft at the altitude selected or programmed.

DESCENT AND APPROACH

Pathways are shown descending only for a programmed descent (Figures 8-5, 8-6). When the flight plan includes programmed descent segments, pathways are displayed along the descent path provided the selected altitude is lower than the programmed altitude.

When an approach providing vertical guidance is activated, Pathways are shown level at the selected altitude up to the point along the final approach course where the altitude intercepts the extended vertical descent path, glidepath, or glideslope. From the vertical path descent, glidepath, or glideslope intercept point, the pathways are shown inbound to the Missed Approach Point (MAP) along the published lateral and vertical descent path, or at the selected altitude, whichever is lower.

During an ILS approach, the initial approach segment is displayed in magenta at the segment altitudes if GPS is selected as the navigation source on the CDI. When switching to localizer inbound with LOC selected as the navigation source on the CDI, pathways are displayed in green along the localizer and glide slope.

VOR, LOC BC, and ADF approach segments that are approved to be flown using GPS are displayed in magenta boxes. Segments that are flown using other than GPS or ILS, such as heading legs or VOR final approach courses are not displayed.

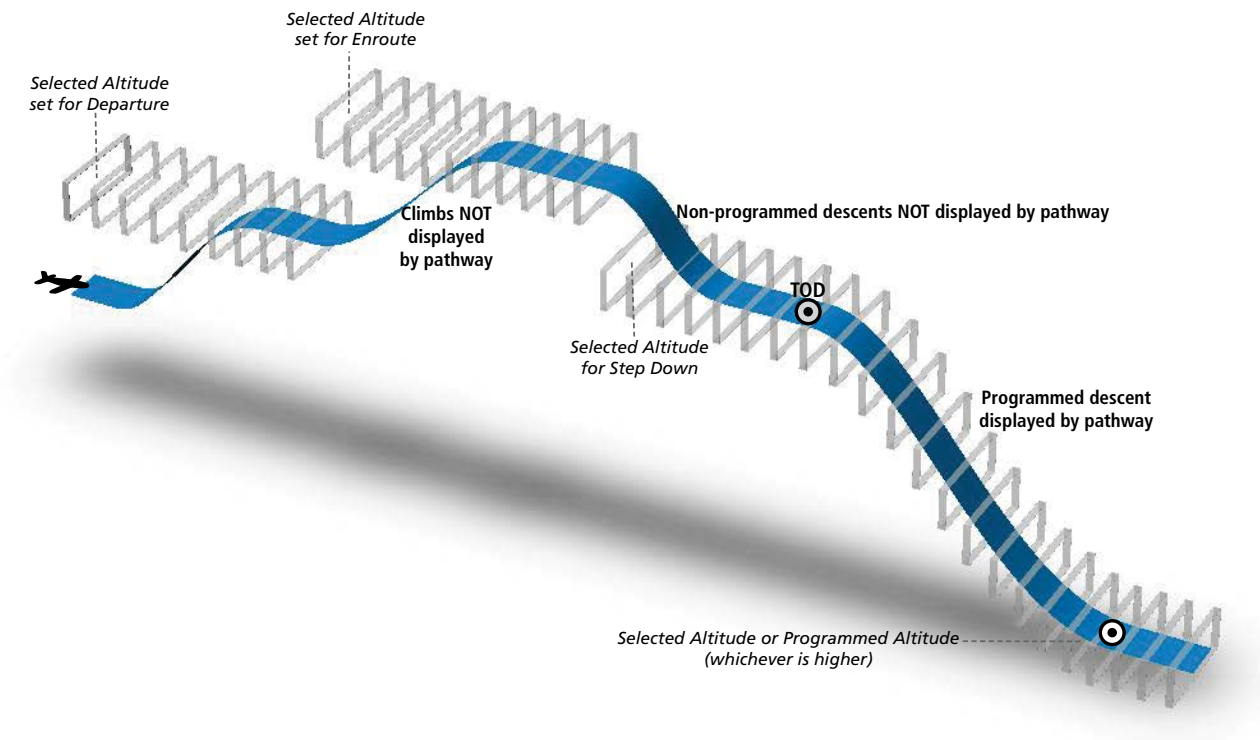

Figure 8-5 SVT Pathways, Enroute and Descent

MISSED APPROACH

Upon activating the missed approach, pathways lead to the Missed Approach Holding Point (MAHP) and are displayed as a level path at the published altitude for the MAHP, or the selected altitude, whichever is the highest. If the initial missed approach leg is a Course-to-Altitude (CA) leg, the pathways boxes will be displayed level at the altitude published for the MAHP. If the initial missed approach leg is defined by a course using other than GPS, pathways are not displayed for that segment. In this case, the pathways displayed for the next leg may be outside the field of view and will be visible when the aircraft has turned in the direction of that leg.

Pathways are displayed along each segment including the path required to track course reversals that are part of a procedure, such as holding patterns. Pathways boxes will not indicate a turn to a MAHP unless a defined geographical waypoint exists between the MAP and MAHP.

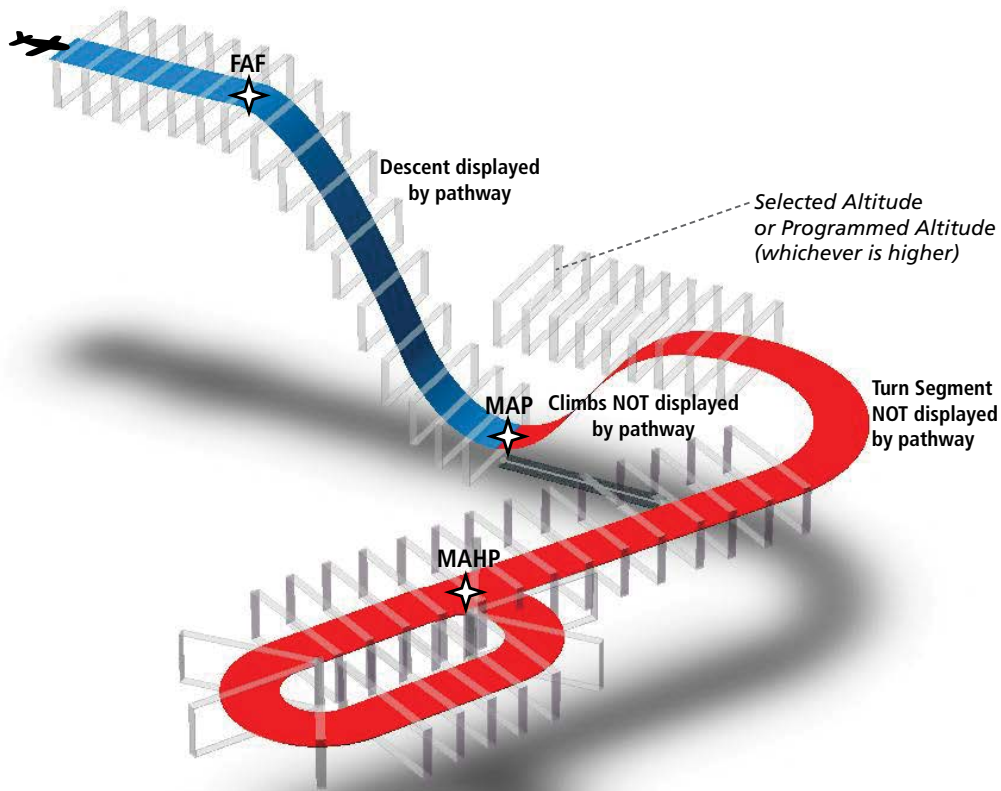

Figure 8-6 SVT Pathways, Approach, Missed Approach, and Holding

SYSTEM OVERVIEW

FLIGHT INSTRUMENTS

EIS

AUDIO PANEL & CNS

FLIGHT MANAGEMENT

HAZARD AVOIDANCE

AFCS

ADDITIONAL FEATURES

APPENDICES

INDEX

FLIGHT PATH MARKER

The Flight Path Marker (FPM), also known as a Velocity Vector, is displayed on the PFD at groundspeeds above 30 knots. The FPM depicts the approximate projected path of the aircraft accounting for wind speed and direction relative to the three-dimensional terrain display and/or horizon and heading.

The FPM is always available when the Synthetic Terrain feature is in operation, however, it may also be enabled independent of the Synthetic Terrain display. The FPM represents the direction of the flight path as it relates to the terrain and obstacles on the display, while the airplane symbol represents the aircraft heading. When SVT is disabled, the FPM represents the flight path in relation to the Zero Pitch Line and heading.

The FPM works in conjunction with the Pathways feature to assist the pilot in maintaining desired altitudes and direction when navigating a flight plan. When on course and altitude the FPM is aligned inside the pathway boxes as shown (Figure 8-7).

When SVT is enabled, the FPM may also be used to identify a possible conflict with the aircraft flight path and distant terrain or obstacles. Displayed terrain or obstacles in the aircraft's flight path extending above the FPM could indicate a potential conflict, even before an alert is issued by TAWS-B or Terrain-SVT. However, decisions regarding terrain and/or obstacle avoidance should not be made using only the FPM.



Figure 8-7 Flight Path Marker and Pathways

ZERO PITCH LINE

The Zero Pitch Line is drawn completely across the display and represents the horizon when the terrain horizon is difficult to distinguish from other terrain being displayed. It may not align with the terrain horizon, particularly when the terrain is mountainous or when the aircraft is flown at high altitudes.

HORIZON HEADING

The Horizon Heading is synchronized with the HSI and shows approximately 60 degrees of compass heading in 30-degree increments on the Zero Pitch Line. Horizon Heading tick marks and digits appearing on the Zero Pitch Line are not visible behind either the airspeed or altitude display. Horizon Heading is used for general heading awareness, and is activated and deactivated by pressing the **HRZN HDG** Softkey.

TRAFFIC



WARNING: Intruder aircraft at or below 500 ft. AGL may not appear on the SVT display or may appear as a partial symbol.

Traffic symbols are displayed in their approximate locations as determined by the related traffic systems. Traffic symbols are displayed in three dimensions, appearing larger as they are getting closer, and smaller when they are further away. Traffic within 250 feet laterally of the aircraft will not be displayed on the SVT display. Traffic symbols and coloring are consistent with that used for traffic displayed in the Inset map or MFD traffic page. If the traffic altitude is unknown, the traffic will not be displayed on the SVT display. For more details refer to the traffic system discussion in the Hazard Avoidance section.

AIRPORT SIGNS

Airport Signs provide a visual representation of airport location and identification on the synthetic terrain display. When activated, the signs appear on the display when the aircraft is approximately 15 nm from an airport and disappear at approximately 4.5 nm. Airport signs are shown without the identifier until the aircraft is approximately eight nautical miles from the airport. Airport signs are not shown behind the airspeed or altitude display. Airport signs are activated and deactivated by pressing the **APTSIGNS** Softkey.



Figure 8-8 Airport Signs

RUNWAYS

WARNING: Do not use SVT runway depiction as the sole means for determining the proximity of the aircraft to the runway or for maintaining the proper approach path angle during landing.

NOTE: Not all airports have runways with endpoint data in the database, therefore, these runways are not displayed.

Runway data provides improved awareness of runway location with respect to the surrounding terrain. All runway thresholds are depicted at their respective elevations as defined in the database. In some situations, where threshold elevations differ significantly, crossing runways may appear to be layered. As runways are displayed, those within 45 degrees of the aircraft heading are displayed in white. Other runways will be gray in color. When an approach for a specific runway is active, that runway will appear brighter and be outlined with a white box, regardless of the runway orientation as related to aircraft heading. As the aircraft gets closer to the runway, more detail such as runway numbers and centerlines will be displayed.



Figure 8-9 Airport Runways

TERRAIN-SVT AND TAWS-B ALERTING

Terrain alerting on the synthetic terrain display is triggered by Forward-looking Terrain Avoidance (FLTA) alerts, and corresponds to the red and yellow X symbols on the Inset Map and MFD map displays. For more detailed information regarding Terrain-SVT and TAWS-B, refer to the Hazard Avoidance Section.

In some instances, a terrain or obstacle alert may be issued with no conflict shading displayed on the synthetic terrain. In these cases, the conflict is outside the SVT field of view to the left or right of the aircraft.



Figure 8-10 Terrain Alert

Obstacles are represented on the synthetic terrain display by standard two-dimensional tower symbols found on the Inset map and MFD maps and charts. Obstacle symbols appear in the perspective view with relative height above terrain and distance from the aircraft. Unlike the Inset map and MFD moving map display, obstacles on the synthetic terrain display do not change colors to warn of potential conflict with the aircraft's flight path until the obstacle is associated with an actual FLTA alert. Obstacles greater than 1000 feet below the aircraft altitude are not shown. Obstacles are shown behind the airspeed and altitude displays.



Figure 8-11 Obstacle

FIELD OF VIEW

The PFD field of view can be represented on the MFD Navigation Map Page. Two dashed lines forming a V-shape in front of the aircraft symbol on the map, represent the forward viewing area shown on the PFD.

Configuring field of view:

- 1) While viewing the Navigation Map Page, press the **MENU** Key to display the PAGE MENU.
- 2) Turn the large **FMS** Knob to highlight Map Setup and press the **ENT** Key.



Navigation Map Page OPTIONS Menu

Map Setup Menu, Map Group, Field of View Option

Figure 8-12 Option Menus

- 3) Turn the **FMS** Knob to select the Map Group and press the **ENT** Key.
- 4) Turn the large **FMS** Knob to scroll through the Aviation Group options to FIELD OF VIEW.
- 5) Turn the small **FMS** Knob to select On or Off.
- 6) Push the **FMS** Knob to return to the Navigation Map Page.

The following figure compares the PFD forward looking depiction with the MFD plan view and FIELD OF VIEW turned on.

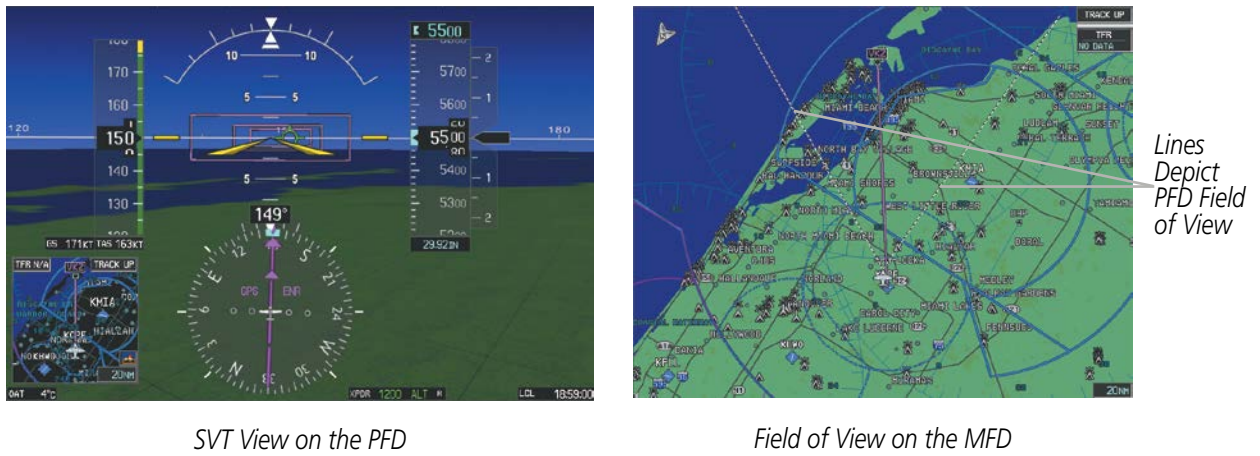

Figure 8-13 MFD and PFD Field of View Comparison

- SYSTEM OVERVIEW
- FLIGHT INSTRUMENTS
- EIS
- AUDIO PANEL & CNS
- FLIGHT MANAGEMENT
- HAZARD AVOIDANCE
- AFCS
- ADDITIONAL FEATURES
- APPENDICES
- INDEX

8.2 ENHANCED VISION SYSTEM & AUXILIARY VIDEO

The Perspective® system provides a control and display interface to an optional Enhanced Vision System and an additional optional video display. EVS is designed to provide an aid to situational awareness while operating in low visibility environments. The EVS camera view is displayed on the AUX - VIDEO page.

EVS IMAGE QUALITY AND INTERPRETATION

Upon power-up the EVS requires approximately 30 seconds to produce a usable image. The image generated is monochrome (black and white). Normally the hotter an object is the whiter it appears on the display.

The EVS periodically calibrates itself to optimize the image. The calibration process can be observed on the display as a one second image interruption, which happens every five minutes or when calibration is manually activated.

Image quality may vary according to target size, target temperature, background temperature, and attenuation from airborne particles or moisture within view of the sensor. If the video signal is ever completely interrupted, the display may appear as a solid field of gray, white, or blue, and the message No Video or NO DATA AVAILABLE may appear.

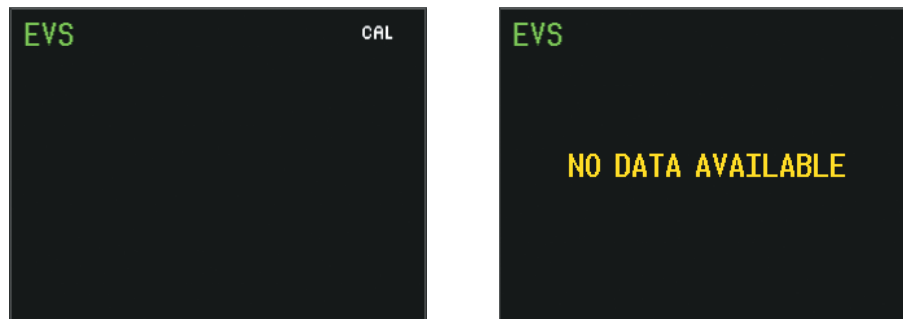

EVS Calibration

EVS Data Unavailable

Figure 8-14 EVS Messages

VIDEO SOFTKEYS

While on the AUX - VIDEO Page, pressing the **VID ZM +** or **VID ZM -** Softkeys increases or decreases video display magnification between 1x and 2x.

Pressing the **HIDE MAP** Softkey removes the map and displays video on the full screen. The softkey label changes to grey with black characters. Pressing the **HIDE MAP** Softkey again restores the map view and the small video image. The softkey label returns to white characters on a black background.

Pressing the **SETUP** Softkey advances to the next level of softkeys: **CNTRST -**, **CNTRST +**, **BRIGHT -**, **BRIGHT +**, **SAT -**, **SAT +**, **RESET**, and **BACK**.

Pressing the **CNTRST -** and **CNTRST +** Softkeys adjust display contrast in five percent increments from 0 to 100%. Pressing the **BRIGHT -** and **BRIGHT +** Softkeys adjust display brightness in five percent increments from 0 to 100%. Pressing the **SAT -** and **SAT +** Softkeys adjust display saturation in five percent increments from 0 to 100%.

Pressing the **RESET** Softkey returns all video adjustments options to the default settings.

While viewing the **SETUP** Softkeys, pressing the **BACK** Softkey or after 45 seconds of softkey inactivity, the system reverts to the AUX - VIDEO Page softkeys.

When a second video input is installed in the system, the **INPUT** Softkey is displayed. Pressing the **INPUT** Softkey switches between the EVS display and the other video source.

The video control softkeys shown below appear on the AUX - VIDEO Page.

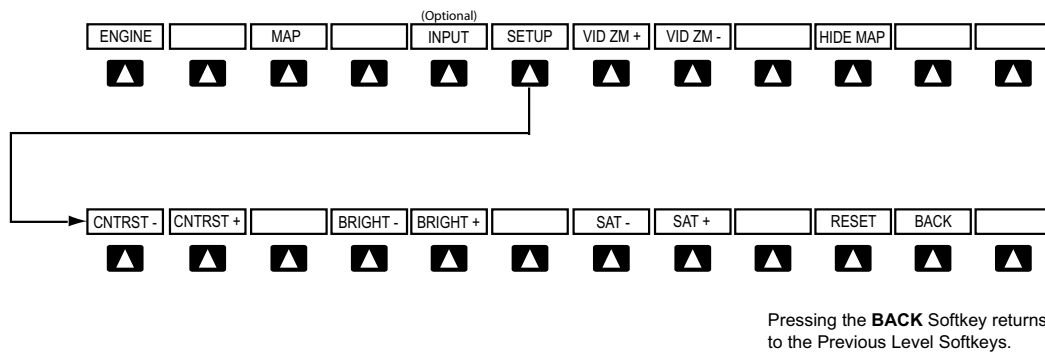

Figure 8-15 Video Softkeys

The video adjustment options can also be selected by using the page menu option.

Selecting video adjustment options:

- 1) While viewing the AUX - VIDEO Page press the **MENU** Key to display the Page Menu **OPTIONS**.
- 2) Turn the large **FMS** Knob to highlight the desired video adjustment option and press the **ENT** Key.

Once the **ENT** key is pressed on any option, the page menu closes and returns to the AUX - VIDEO Page.



Figure 8-16 AUX - VIDEO Page Menu

- SYSTEM OVERVIEW
- FLIGHT INSTRUMENTS
- EIS
- AUDIO PANEL & CNS
- FLIGHT MANAGEMENT
- HAZARD AVOIDANCE
- AFCS
- ADDITIONAL FEATURES
- APPENDICES
- INDEX



Figure 8-17 EVS and Map on the AUX - Video Page



Figure 8-18 Full Screen EVS Image

ZOOM/RANGE

Pressing the **VID ZM +** or **VID ZM -** Softkeys increases or decreases video display magnification between 1x and 10x.

The **Joystick** can be used to increase or decrease the range setting on the map display or zoom in and out on the video display. While in the Split-Screen mode, pressing the **MAP ACTV** or **VID ACTV** Softkey determines which display the **Joystick** adjusts. Pressing the softkey to display MAP ACTV allows the **Joystick** to control the range setting of the map display. Pressing the softkey to display VID ACTV allows the **Joystick** to control the zoom setting of the video display.

When zooming in on the video display, a Zoom Window will appear in the upper right of the display. A box within this window indicates the portion of the display currently being viewed. The currently displayed portion of the full display may be adjusted by using Joystick.

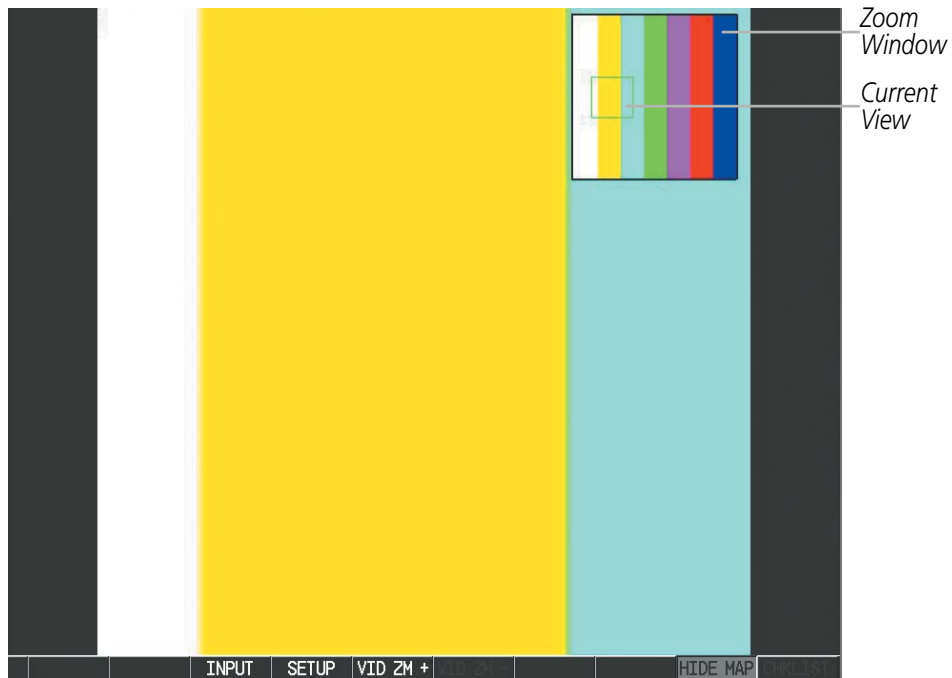

Figure 8-19 Zoom Window

8.3 SAFETAXI

SafeTaxi is an enhanced feature that gives greater map detail when viewing airports at close range. The maximum map ranges for enhanced detail are pilot configurable. When viewing at ranges close enough to show the airport detail, the map reveals taxiways with identifying letters/numbers, airport Hot Spots, and airport landmarks including ramps, buildings, control towers, and other prominent features. Resolution is greater at lower map ranges. When the MFD display is within the SafeTaxi ranges, the airplane symbol on the airport provides enhanced position awareness.

Designated Hot Spots are recognized at airports with many intersecting taxiways and runways, and/or complex ramp areas. Airport Hot Spots are outlined to caution pilots of areas on an airport surface where positional awareness confusion or runway incursions happen most often. Hot Spots are defined with a magenta circle or outline around the region of possible confusion.

Any map page that displays the navigation view can also show the SafeTaxi airport layout within the maximum configured range. The following is a list of pages where the SafeTaxi feature can be seen:

- Navigation Map Page
- Inset Map (PFD)
- Weather Datalink Page
- Airport Information Page
- Intersection Information Page
- NDB Information Page
- VOR Information Page
- User Waypoint Information Page
- Trip Planning Page
- Nearest Pages
- Active and Stored Flight Plan Pages

During ground operations the aircraft's position is displayed in reference to taxiways, runways, and airport features. In the example shown, the aircraft is on taxiway Bravo inside the High Alert Intersection boundary on KSFO airport. Airport Hot Spots are outlined in magenta. When panning over the airport, features such as runway holding lines and taxiways are shown at the cursor.

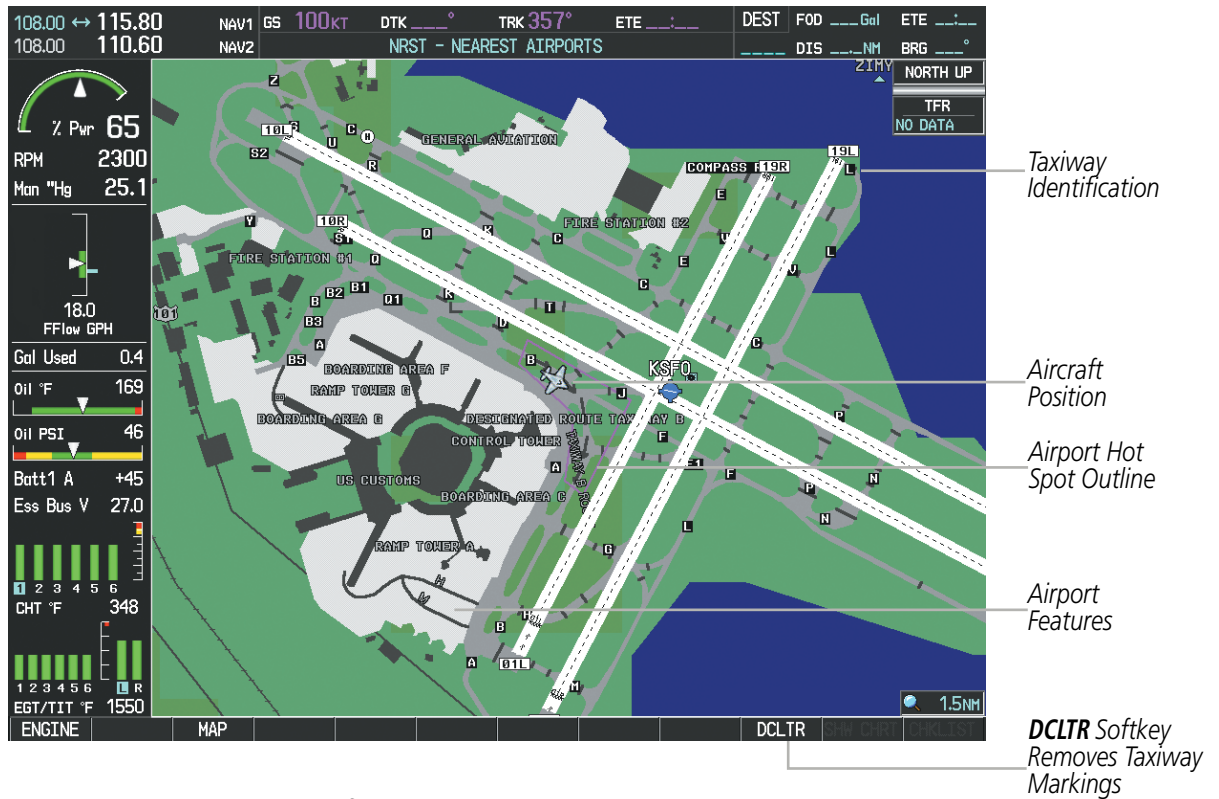

Figure 8-20 SafeTaxi Depiction on the Navigation Map Page

The **DCLTR** Softkey (declutter) label advances to DCLTR-1, DCLTR -2, and DCLTR-3 each time the softkey is pressed for easy recognition of decluttering level. Pressing the **DCLTR** Softkey removes the taxiway markings and airport feature labels. Pressing the **DCLTR-1** Softkey removes VOR and station ID, the VOR symbol, and intersection names if within the airport plan view. Pressing the **DCLTR-2** Softkey removes the airport diagram and runway layout, unless the airport in view is part of an active route structure. Pressing the **DCLTR-3** Softkey cycles back to the original map detail. Refer to Map Declutter Levels in the Flight Management Section.

SYSTEM OVERVIEW

FLIGHT INSTRUMENTS

EIS

AUDIO PANEL & CNS

FLIGHT MANAGEMENT

HAZARD AVOIDANCE

AFCS

ADDITIONAL FEATURES

APPENDICES

INDEX

Configuring SafeTaxi range:

- 1) While viewing the Navigation Map Page, press the **MENU** Key to display the PAGE MENU.
- 2) Turn the large **FMS** Knob to highlight the Map Setup Menu Option and press the **ENT** Key.

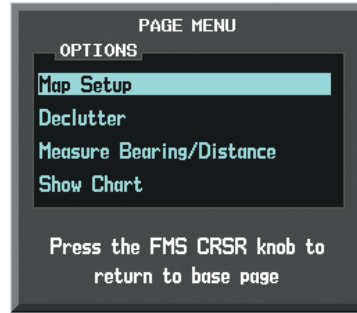

Figure 8-21 Navigation Map PAGE MENU, Map Setup Option

- 3) Turn the **FMS** Knob to select the Aviation Group and press the **ENT** Key.
- 4) Turn the large **FMS** Knob to scroll through the Aviation Group options to SAFETAXI.
- 5) Turn the small **FMS** Knob to display the range of distances.
- 6) Turn either **FMS** Knob to select the desired distance for maximum SafeTaxi display range.
- 7) Press the **ENT** Key to complete the selection.
- 8) Push the **FMS** Knob to return to the Navigation Map Page.

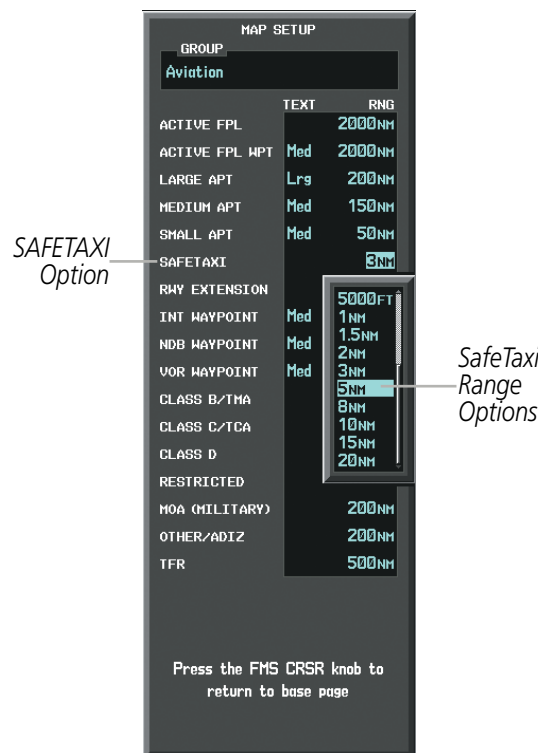

Figure 8-22 MAP SETUP Menu, Aviation Group, SAFETAXI Range Options

8.4 CHARTVIEW

The optional ChartView charts resemble the paper version of Jeppesen terminal procedures charts. The charts are displayed in full color with high-resolution. The MFD depiction shows the aircraft position on the moving map in the planview of approach charts and on airport diagrams. Airport Hot Spots are outlined in magenta.

The geo-referenced aircraft position is indicated by an aircraft symbol displayed on the chart when the current position is within the boundaries of the chart. Inset boxes (Figure 8-23) are not considered within the chart boundaries. Therefore, when the aircraft symbol reaches a chart boundary line, or inset box, the aircraft symbol is removed from the display.

Figure 8-23 shows examples of off-scale areas, indicated by the grey shading. Note, the grey shading is for illustrative purposes only and will not appear on the published chart or MFD display. These off-scale areas appear on the chart to convey supplemental information. However, the depicted geographical position of this information, as it relates to the chart planview, is not the actual geographic position. Therefore, when the aircraft symbol appears within one of these areas, the aircraft position indicated is relative to the chart planview, not to the off-scale area.

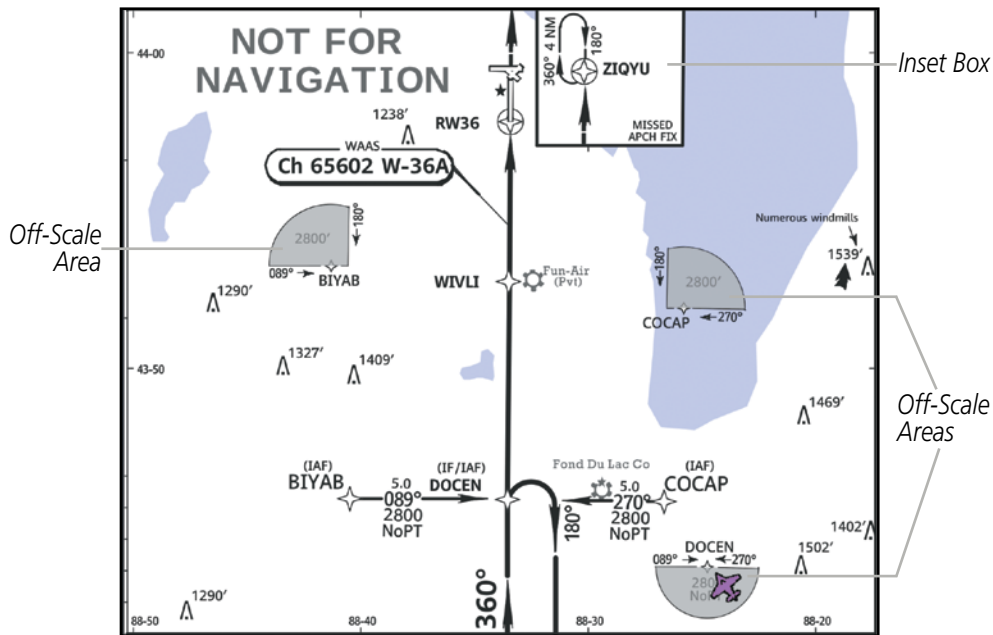

Figure 8-23 Sample Chart Indicating Off-Scale Areas



NOTE: Do not maneuver the aircraft based solely upon the geo-referenced aircraft symbol.

The ChartView database subscription is available from Jeppesen, Inc. Available data includes:

- Arrivals (STAR)
- Departure Procedures (DP)
- Approaches
- Airport Diagrams
- Bottlang VFR Charts (additional subscription)
- NOTAMs

CHARTVIEW SOFTKEYS

ChartView functions are displayed on three levels of softkeys. While on the Navigation Map Page, Nearest Airports Page, or Flight Plan Page, pressing the **SHW CHRT** Softkey displays the available terminal chart and advances to the chart selection level of softkeys: **CHRT OPT**, **CHRT**, **INFO**, **DP**, **STAR**, **APR**, **WX**, **NOTAM**, and **GO BACK**. The chart selection softkeys shown below appear on the Airport Information Page.

Pressing the **GO BACK** Softkey reverts to the top level softkeys and previous page.

Pressing the **CHRT OPT** Softkey advances to the next level of softkeys: **ALL**, **HEADER**, **PLAN**, **PROFILE**, **MINIMUMS**, **FIT WDTN**, **FULL SCN**, and **BACK**.

While viewing the **CHRT OPT** Softkeys, after 45 seconds of softkey inactivity, the system reverts to the chart selection softkeys.

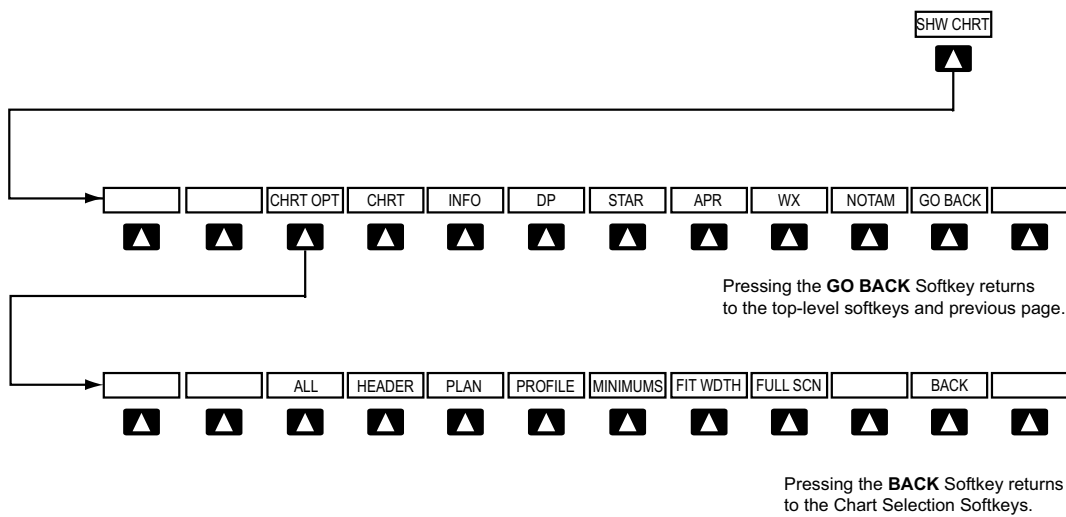

Figure 8-24 ChartView SHW CHRT, Chart Selection, and Chart Option Softkeys

TERMINAL PROCEDURES CHARTS

Selecting Terminal Procedures Charts:

While viewing the Navigation Map Page, Nearest Airport Page, or Flight Plan Page, press the **SHW CHRT** Softkey.

Or:

- 1) Press the **MENU** Key to display the PAGE MENU.
- 2) Turn the large **FMS** Knob to scroll through the OPTIONS Menu to Show Chart.
- 3) Press the **ENT** Key to display the chart.

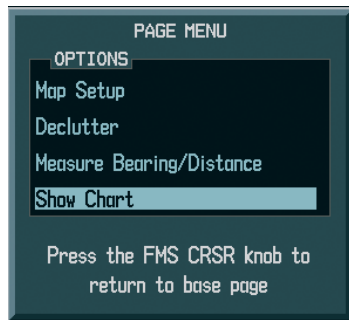

Navigation Map Page OPTIONS Menu



Waypoint Airport Information Page OPTIONS Menu

Figure 8-25 Option Menus

When no terminal procedure chart is available for the nearest airport or the selected airport, the banner **CHART NOT AVAILABLE** appears on the screen. The **CHART NOT AVAILABLE** banner does not refer to the Jeppesen subscription, but rather the availability of a particular airport chart selection or procedure for a selected airport.



Figure 8-26 Chart Not Available Banner

If there is a problem in rendering the data (such as a data error or a failure of an individual chart), the banner **UNABLE TO DISPLAY CHART** is then displayed.



Figure 8-27 Unable To Display Chart Banner

When a chart is not available by pressing the **SHW CHRT** Softkey or selecting a Page Menu Option, charts may be obtained for other airports from the WPT Pages or Flight Plan Pages.

If a chart is available for the destination airport, or the airport selected in the active flight plan, the chart appears on the screen. When no flight plan is active, or when not flying to a direct-to destination, pressing the **SHW CHRT** Softkey displays the chart for the nearest airport, if available.

The chart shown is the one associated with the WPT – Airport Information page. Usually this is the airport runway diagram. Where no runway diagram exists, but Take Off Minimums or Alternate Minimums are available, that page appears. If Airport Information pages are unavailable, the Approach Chart for the airport is shown.

Selecting a chart:

- 1) While viewing the Navigation Map Page, Flight Plan Page, or Nearest Airports Page, press the **SHW CHRT** Softkey. The airport diagram or approach chart is displayed on the Airport Information Page.
- 2) Push the **FMS** Knob to activate the cursor.
- 3) Turn the large **FMS** Knob to select either the Airport Identifier Box or the Approach Box. (Press the **APR** Softkey if the Approach Box is not currently shown).
- 4) Turn the small and large **FMS** Knob to enter the desired airport identifier.
- 5) Press the **ENT** Key to complete the airport selection.
- 6) Turn the large **FMS** Knob to select the Approach Box.
- 7) Turn the small **FMS** Knob to show the approach chart selection choices.
- 8) Turn either **FMS** Knob to scroll through the available charts.
- 9) Press the **ENT** Key to complete the chart selection.

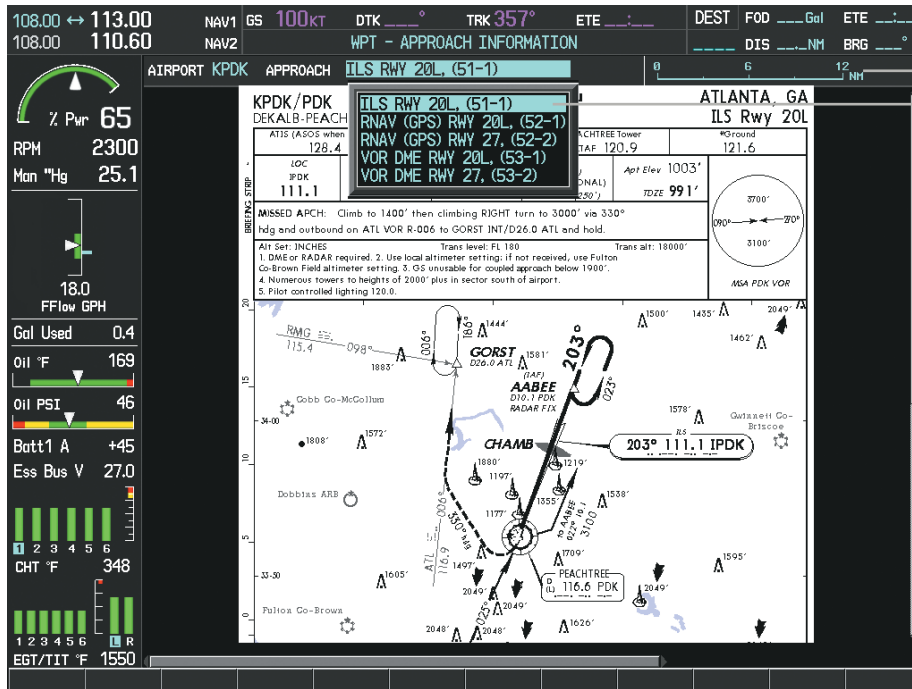

Chart Scale
Select Desired
Approach Chart
From Menu

Scroll Through
Chart With
the Joystick

Figure 8-28 Approach Information Page, Chart Selection

While the APPROACH Box is selected using the **FMS** Knob, the MFD softkeys are blank. Once the desired chart is selected, the chart scale can be changed and the chart page can be scrolled using the **Joystick**. Pressing the **Joystick** centers the chart on the screen.

The aircraft symbol is shown on the chart only if the chart is to scale and the aircraft position is within the boundaries of the chart. The aircraft symbol is not displayed when the Aircraft Not Shown Icon appears. If the Chart Scale Box displays a banner NOT TO SCALE, the aircraft symbol is not shown. The Aircraft Not Shown Icon may appear at certain times, even if the chart is displayed to scale.

Pressing the **CHRT** Softkey switches between the ChartView diagram and the associated map in the WPT page group. In the example shown, the **CHRT** Softkey switches between the Colorado Springs, CO (KCOS) Airport Diagram and the navigation map on the WPT – Airport Information page.

- SYSTEM OVERVIEW
- FLIGHT INSTRUMENTS
- EIS
- AUDIO PANEL & CNS
- FLIGHT MANAGEMENT
- HAZARD AVOIDANCE
- AFCS
- ADDITIONAL FEATURES
- APPENDICES
- INDEX

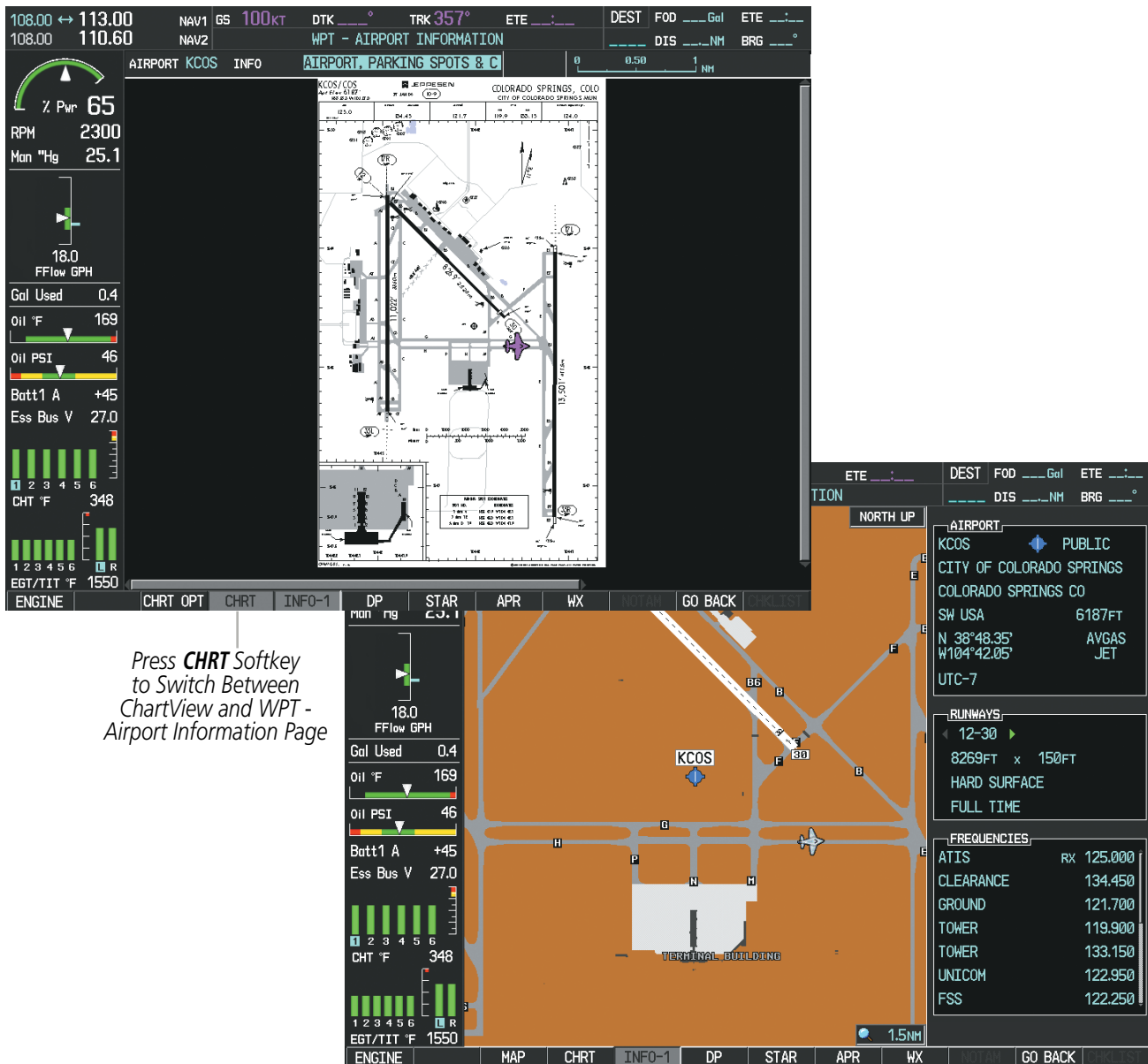

Figure 8-29 CHRT Softkey, Airport Information Page

Pressing the **INFO-1** or **INFO-2** Softkey returns to the airport diagram chart when the view is on a terminal procedure chart. If the displayed chart is the airport diagram chart, pressing the **INFO-1** or **INFO-2** Softkey returns to the Airport Information Page.

The aircraft position is shown in magenta on the ChartView diagrams when the location of the aircraft is within the chart boundaries. In the example shown, the aircraft is turning onto Taxiway Romeo on the Charlotte, NC (KCLT) airport.

Another source for additional airport information is from the INFO Box above the chart for certain airports. This information source is not related to the **INFO-1** or **INFO-2** Softkey. When the INFO Box is selected using the **FMS** Knob, the MFD softkeys are blank. The Charlotte, NC airport has five additional charts offering information; the Airport Diagram, Take-off Minimums, Class B Airspace, Airline Parking Gate Coordinates, and Airline Parking Gate Location. The numbers in parentheses after the chart name are Jeppesen designators. When a European airport is displayed on the WPT- Airport Information Page, the INFO Box will also list appropriate VFR charts, provided the Bottlang Chart subscription has been added to the ChartView database.



Figure 8-30 Airport Information Page, INFO View, Full Screen Width

In the example shown in Figure 8-31, the Class B Chart is selected. Pressing the **ENT** Key displays the Charlotte Class B Airspace Chart (Figure 8-31).

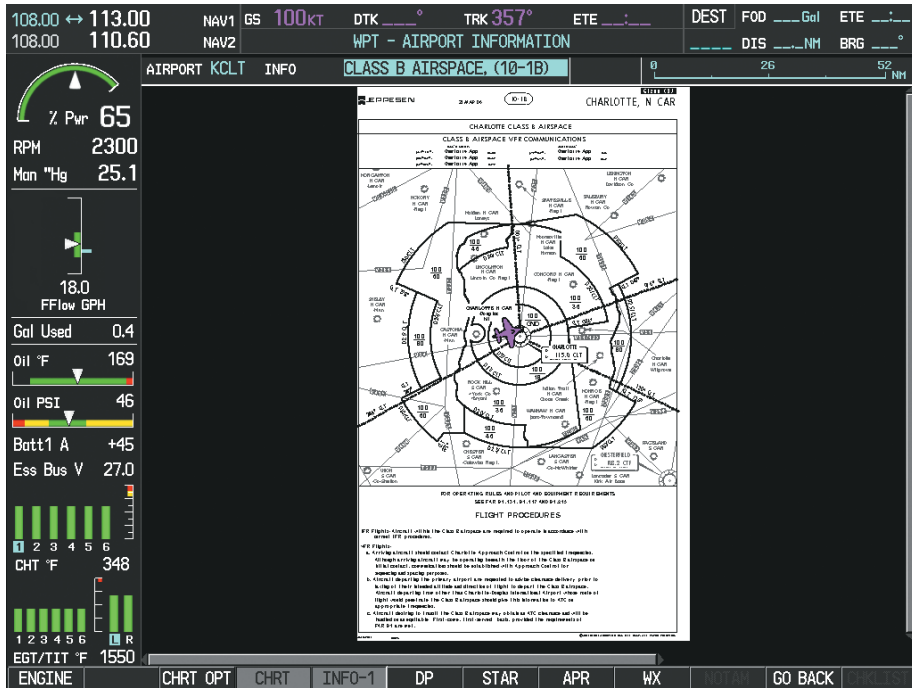

Figure 8-31 Airport Information Page, Class B Chart Selected from INFO View

Pressing the **DP** Softkey displays the Departure Procedure Chart if available.

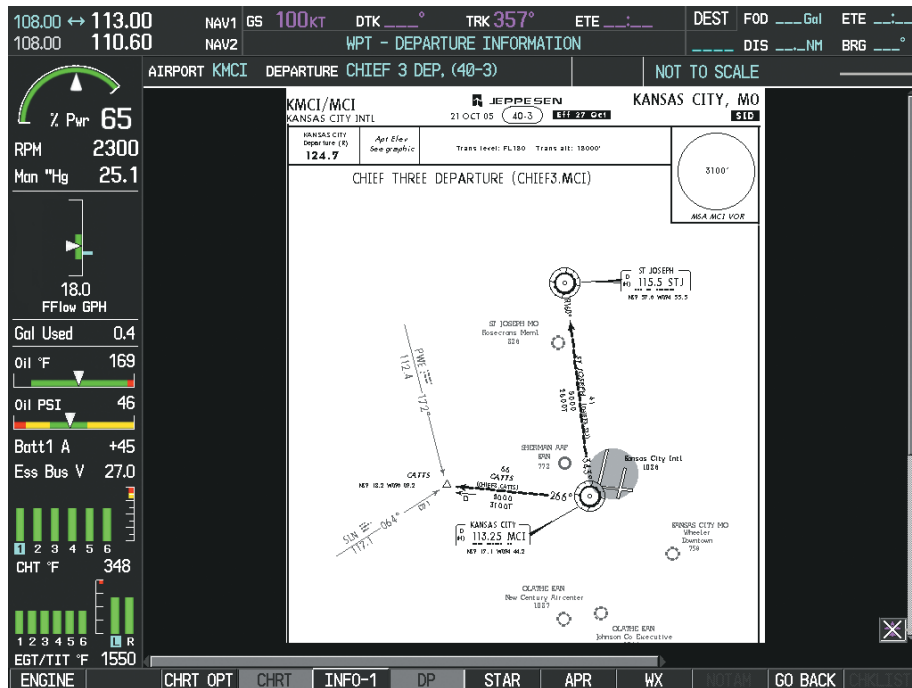

Figure 8-32 Departure Information Page

Pressing the **STAR** Softkey displays the Standard Terminal Arrival Chart if available.

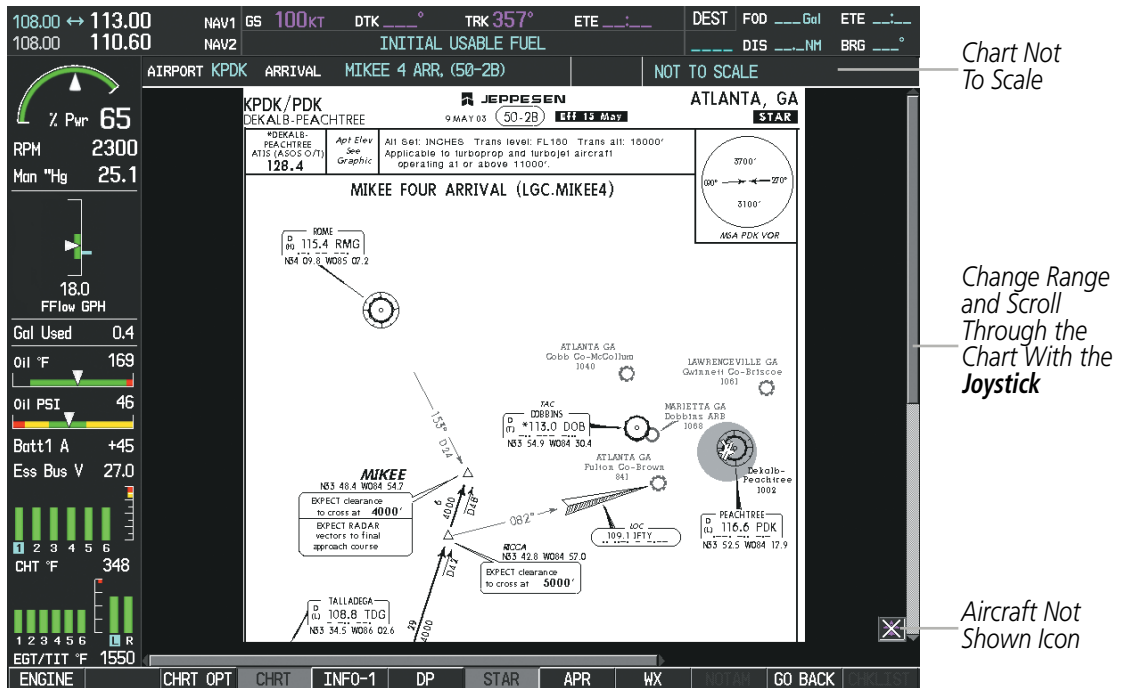

Figure 8-33 Arrival Information Page

Pressing the **APR** Softkey displays the approach chart for the airport if available.

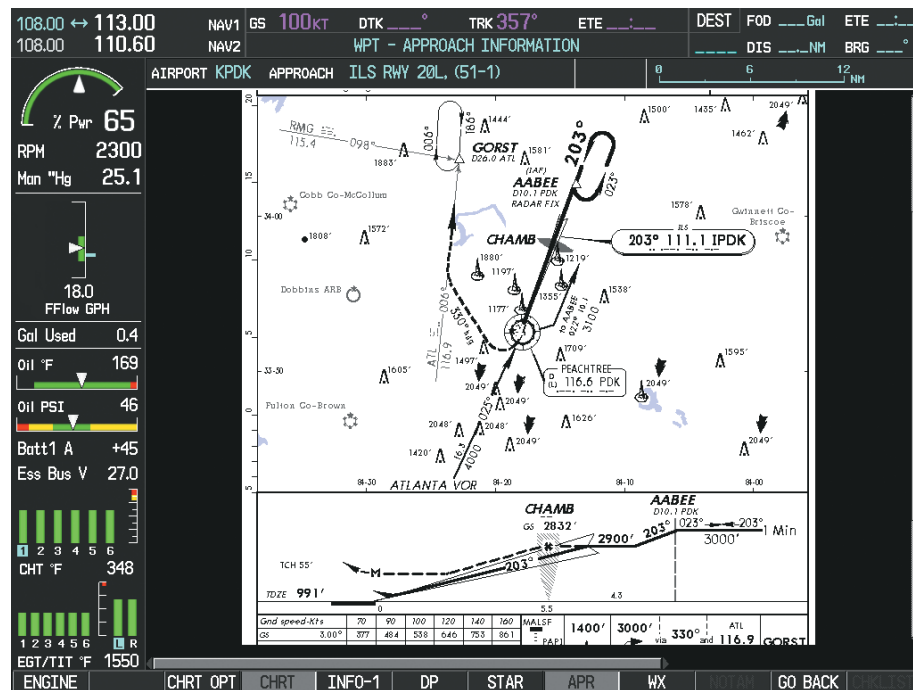

Figure 8-34 Approach Information Page

SYSTEM OVERVIEW

FLIGHT INSTRUMENTS

EIS

AUDIO PANEL & CNS

FLIGHT MANAGEMENT

HAZARD AVOIDANCE

AFCS

ADDITIONAL FEATURES

APPENDICES

INDEX

Pressing the **WX** Softkey shows the airport weather frequency information, and includes weather data such as METAR and TAF from the XM Data Link Receiver, when available. Weather information is available only when an XM Data Link Receiver is installed and the SiriusXM Weather subscription is current.

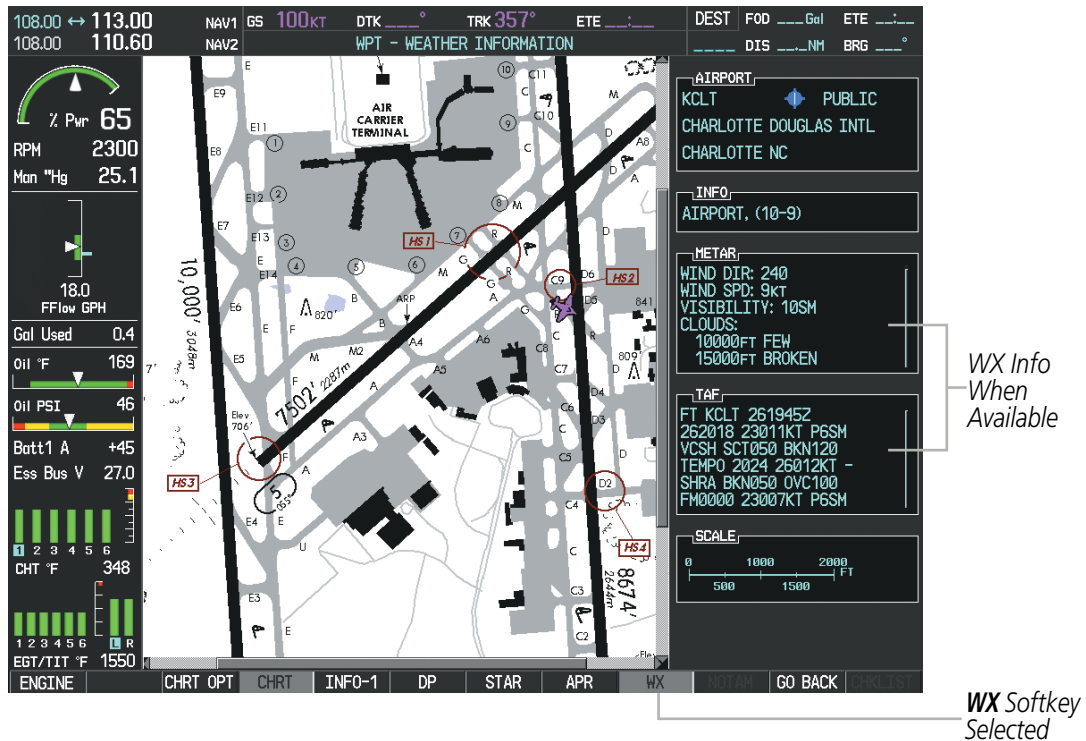
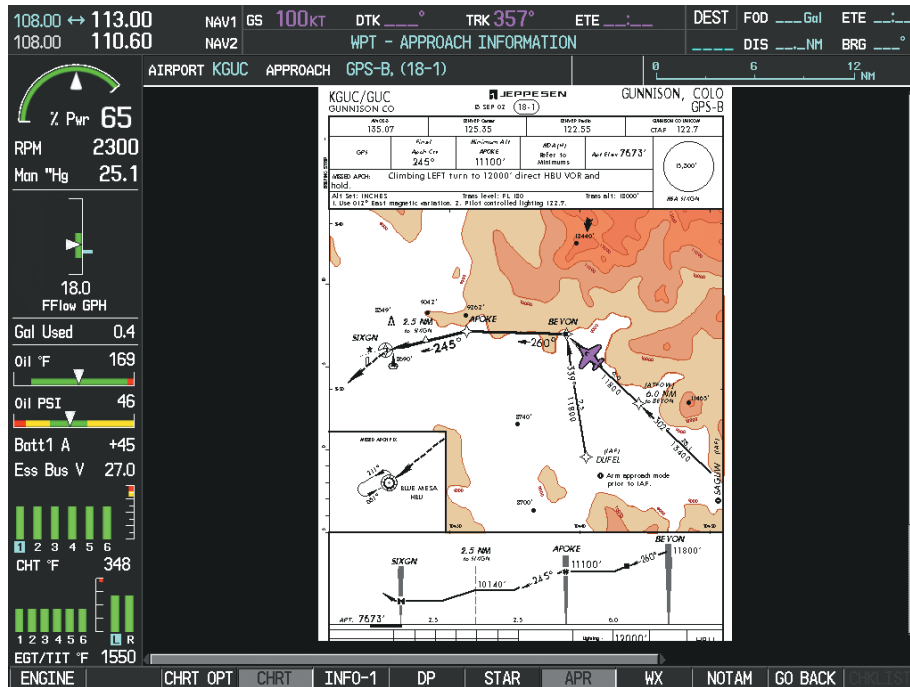

Figure 8-35 Weather Information Page

NOTE: A subdued softkey label indicates the function is disabled.

Recent NOTAMS applicable to the current ChartView cycle are included in the ChartView database. Pressing the **NOTAM** Softkey shows the local NOTAM information for selected airports, when available. When NOTAMS are not available, the **NOTAM** Softkey label appears subdued and is disabled. The **NOTAM** Softkey may appear on the Airport Information Page and all of the chart page selections.



NOTAM Softkey Appears for Selected Airports

Figure 8-36 NOTAM Softkey Highlighted

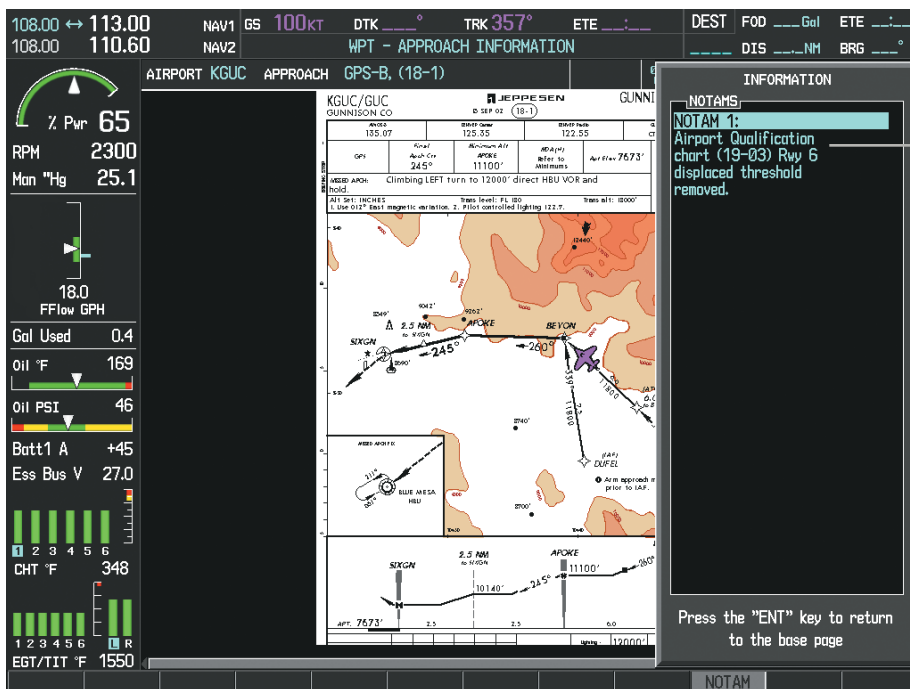

Local NOTAM on This Airport

NOTAM Softkey Selected

Figure 8-37 Airport Information Page, Local NOTAMS

Pressing the **NOTAM** Softkey again removes the NOTAMS information.

Pressing the **GO BACK** Softkey reverts to the previous page (Navigation Map Page, Nearest Pages, or Flight Plan Page).

SYSTEM OVERVIEW

FLIGHT INSTRUMENTS

EIS

AUDIO PANEL & CNS

FLIGHT MANAGEMENT

HAZARD AVOIDANCE

AFCS

ADDITIONAL FEATURES

APPENDICES

INDEX

CHART OPTIONS

Pressing the **CHRT OPT** Softkey displays the next level of softkeys, the chart options level (Figure 8-38). Pressing the **ALL** Softkey shows the complete approach chart on the screen.

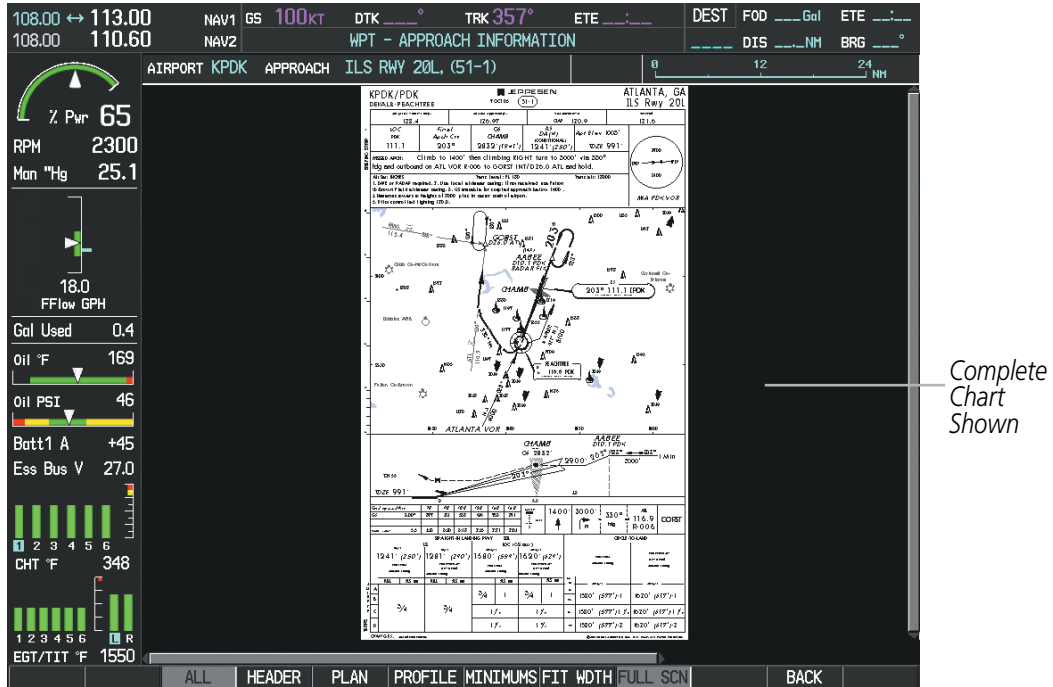

Figure 8-38 Approach Information Page, ALL View

Pressing the **HEADER** Softkey shows the header view (approach chart briefing strip) on the screen.

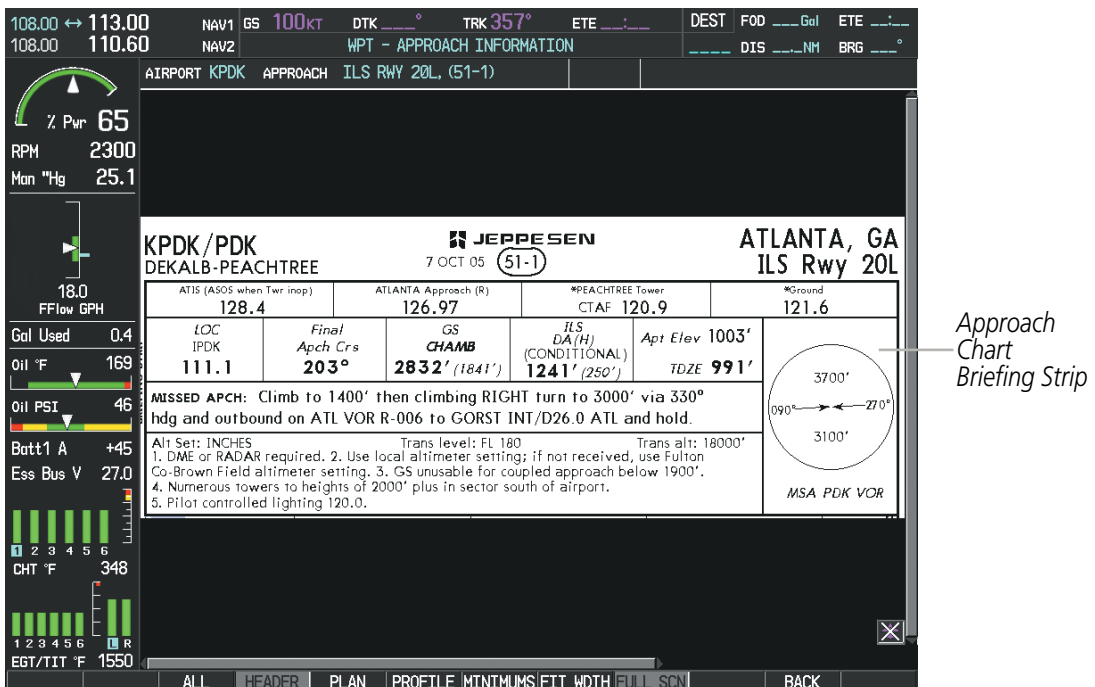
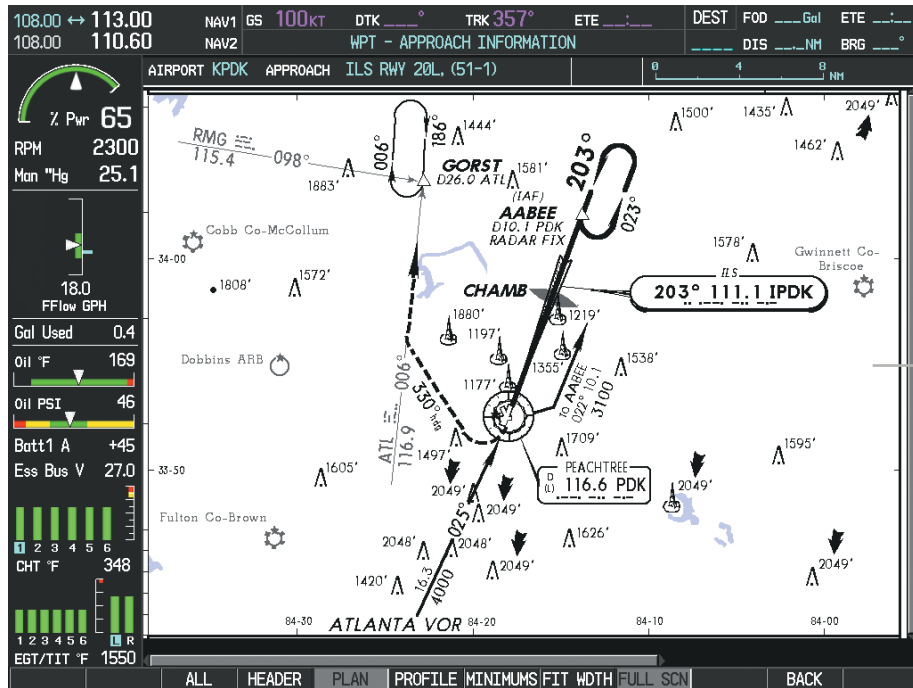

Figure 8-39 Approach Information Page, Header View

Pressing the **PLAN** Softkey shows the approach chart two dimensional plan view.



Approach Chart Plan View

Figure 8-40 Approach Information Page, Plan View

Pressing the **PROFILE** Softkey displays the approach chart descent profile strip.

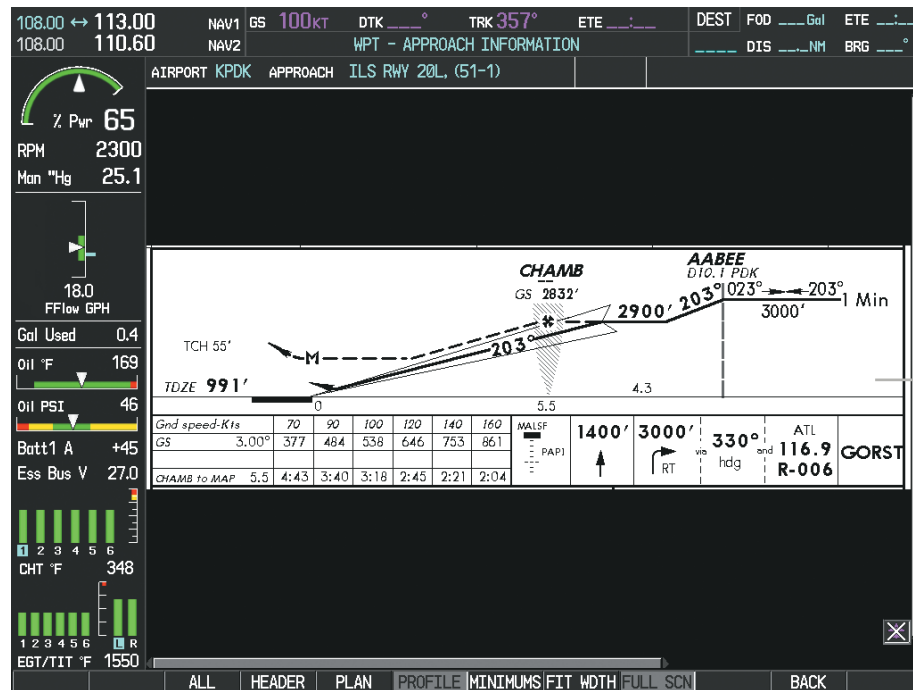

Approach Chart Descent Profile Strip

Figure 8-41 Approach Information Page, Profile View, Full Screen Width

SYSTEM OVERVIEW

FLIGHT INSTRUMENTS

EIS

AUDIO PANEL & CNS

FLIGHT MANAGEMENT

HAZARD AVOIDANCE

AFCS

ADDITIONAL FEATURES

APPENDICES

INDEX

Pressing the **MINIMUMS** Softkey displays the minimum descent altitude/visibility strip at the bottom of the approach chart.

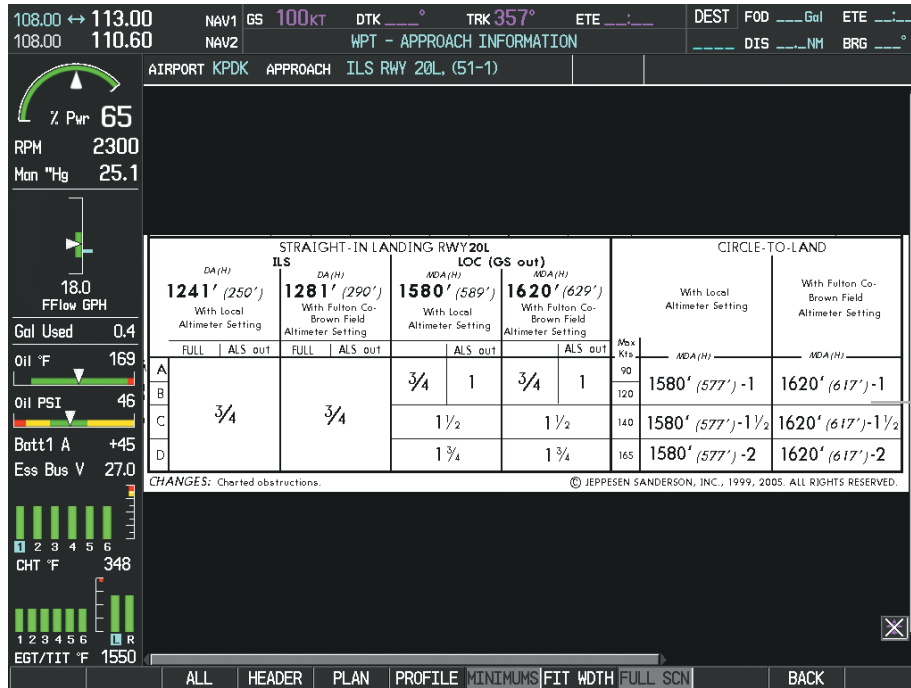

Minimum Descent Altitude/Visibility Strip

Figure 8-42 Approach Information Page, Minimums View, Full Screen Width

If the chart scale has been adjusted to view a small area of the chart, pressing the **FIT WIDTH** Softkey changes the chart size to fit the available screen width.



Press **FIT WIDTH** Softkey to Show Full Chart Width

Figure 8-43 Airport Information Page, FIT WIDTH Softkey Selected

Pressing the **FULL SCN** Softkey alternates between removing and replacing the data window to the right.

Selecting Additional Information:

- 1) While viewing the Airport Taxi Diagram, press the **FULL SCN** Softkey to display the information windows (AIRPORT, INFO).
- 2) Push the **FMS** Knob to activate the cursor.
- 3) Turn the large **FMS** Knob to highlight the AIRPORT, INFO, RUNWAYS, or FREQUENCIES Box (INFO Box shown).
- 4) Turn the small **FMS** Knob to select the INFO Box choices. If multiple choices are available, scroll to the desired choice with the large **FMS** Knob and press the **ENT** Key to complete the selection.
- 5) Push the **FMS** Knob again to deactivate the cursor.

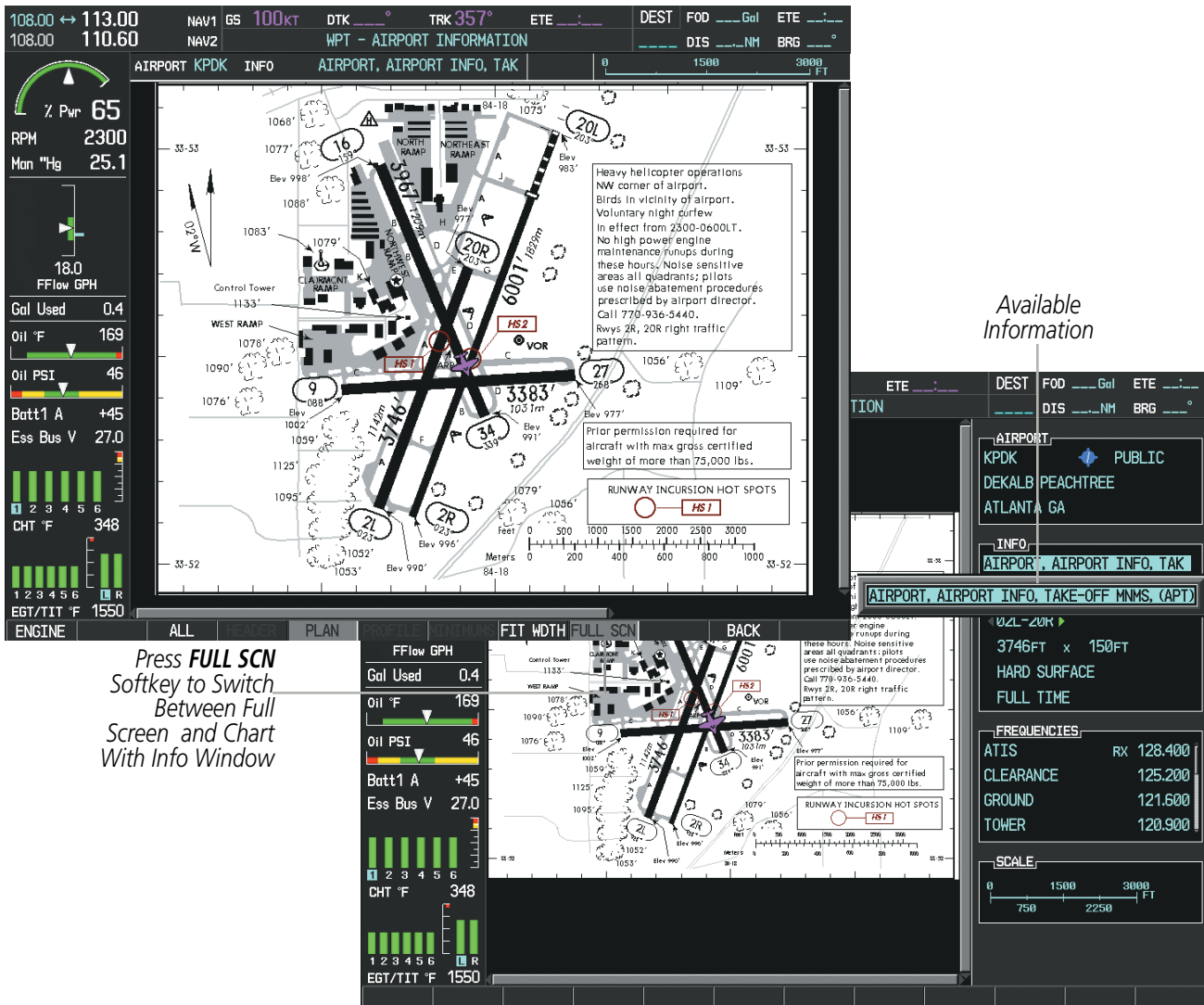

Figure 8-44 Airport Information Page, Full Screen and Info Window

Pressing the **BACK** Softkey, or waiting for 45 seconds reverts to the chart selection softkeys.

The full screen view can also be selected by using the page menu option.

Selecting full screen On or Off:

- 1) While viewing a terminal chart press the **MENU** Key to display the Page Menu OPTIONS.
- 2) Turn the large **FMS** Knob to highlight the Chart Setup Menu Option and press the **ENT** Key.
- 3) Turn the large **FMS** Knob to move between the FULL SCREEN and COLOR SCHEME Options.
- 4) Turn the small **FMS** Knob to choose between the On and Off Full Screen Options.

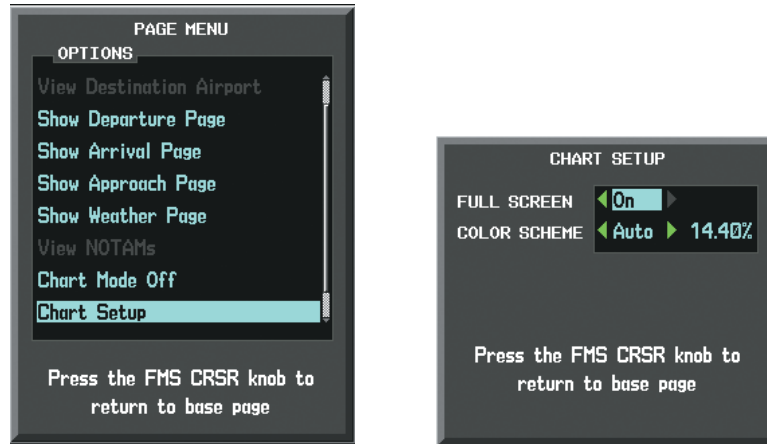

Chart Setup Option

Full Screen On/Off Selection

Figure 8-45 Page Menus

DAY/NIGHT VIEW

ChartView can be displayed on a white or black background for day or night viewing. The Day View offers a better presentation in a bright environment. The Night View gives a better presentation for viewing in a dark environment. When the CHART SETUP Box is selected the MFD softkeys are blank.

Selecting Day, Night, or Automatic View:

- 1) While viewing a terminal chart press the **MENU** Key to display the Page Menu OPTIONS.
- 2) Turn the large **FMS** Knob to highlight the Chart Setup Menu Option and press the **ENT** Key.

- SYSTEM OVERVIEW
- FLIGHT INSTRUMENTS
- EIS
- AUDIO PANEL & CNS
- FLIGHT MANAGEMENT
- HAZARD AVOIDANCE
- AFCS
- ADDITIONAL FEATURES
- APPENDICES
- INDEX

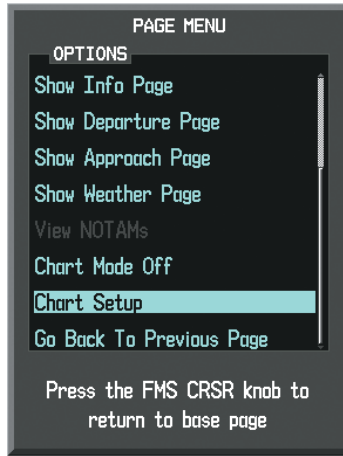

Figure 8-46 Waypoint Information Page, OPTIONS Menu

- 3) Turn the large **FMS** Knob to move to the COLOR SCHEME Option (Figure 8-48).
- 4) Turn the small **FMS** Knob to choose between Day, Auto, and Night Options.
- 5) If Auto Mode is selected, turn the large **FMS** Knob to select the percentage field. Use the small **FMS** Knob to change the percentage value. The percentage value is the day/night crossover point based on the percentage of backlighting intensity. For example, if the value is set to 15%, the day/night display changes when the display backlight reaches 15% of full brightness.

The display must be changed in order for the new setting to become active. This may be accomplished by selecting another page or changing the display range.

- 6) Push the **FMS** Knob when finished to remove the Chart Setup Menu.

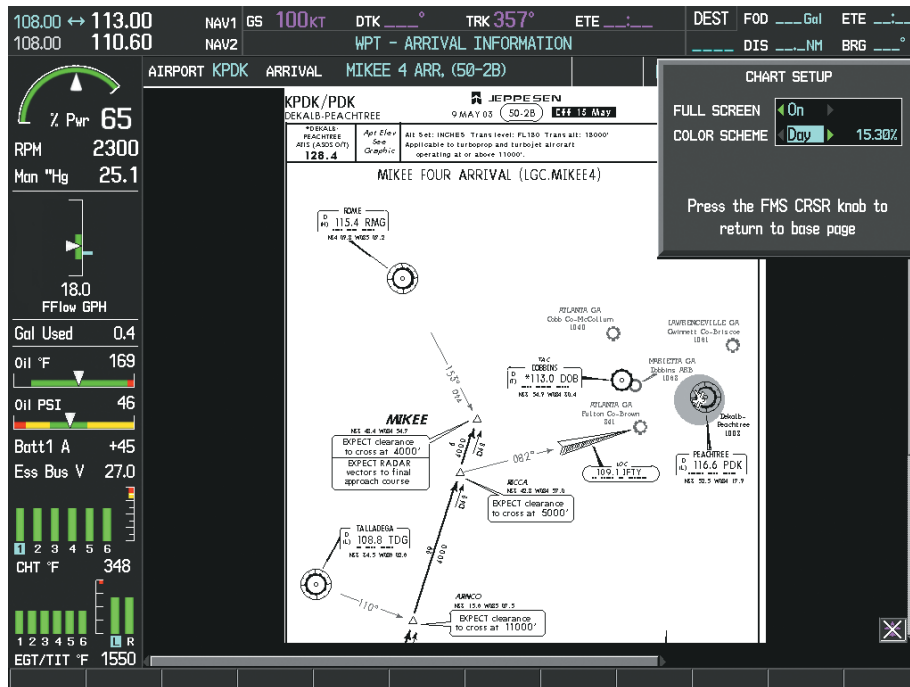

Figure 8-47 Arrival Information Page, Day View

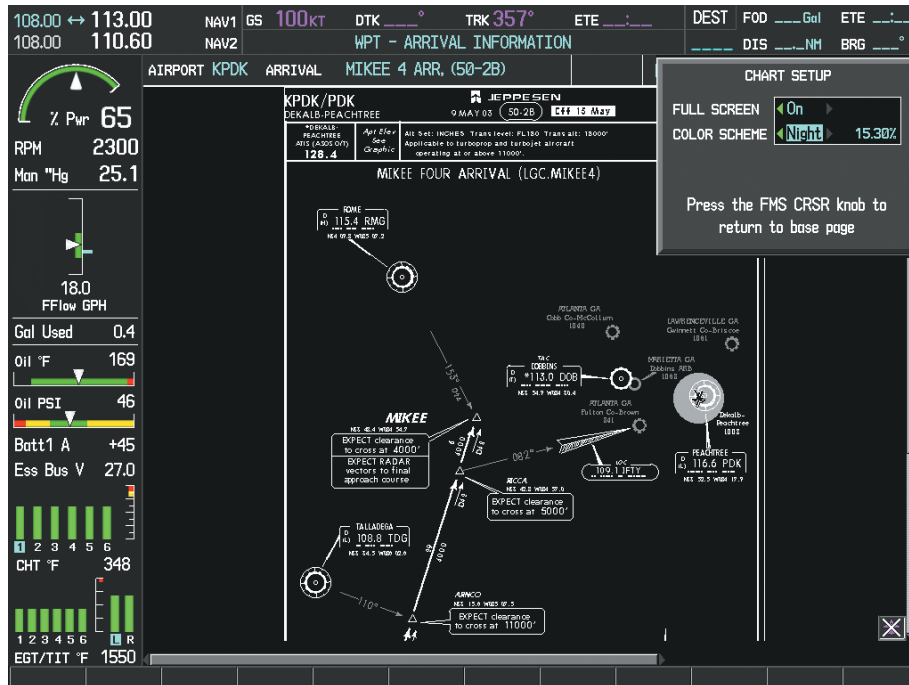

Figure 8-48 Arrival Information Page, Night View

SYSTEM OVERVIEW

FLIGHT INSTRUMENTS

EIS

AUDIO PANEL & CNS

FLIGHT MANAGEMENT

HAZARD AVOIDANCE

AFCS

ADDITIONAL FEATURES

APPENDICES

INDEX

8.5 FLITECHARTS

FliteCharts resemble the paper version of AeroNav Services terminal procedures charts. The charts are displayed with high-resolution and in color for applicable charts. The MFD depiction shows the aircraft position on the moving map in the planview of approach charts.

The geo-referenced aircraft position is indicated by an aircraft symbol displayed on the chart when the current position is within the boundaries of the chart. An aircraft symbol may be displayed within an off-scale area depicted on some charts.

Figure 8-49 shows examples of off-scale areas, indicated by the grey shading. Note, these areas are not shaded on the published chart. These off-scale areas appear on the chart to convey supplemental information. However, the depicted geographical position of this information, as it relates to the chart planview, is not the actual geographic position. Therefore, when the aircraft symbol appears within one of these areas, the aircraft position indicated is relative to the chart planview, not to the off-scale area.

The FliteCharts database subscription is available from Garmin. Available data includes:

- Arrivals (STAR)
- Approaches
- Departure Procedures (DP)
- Airport Diagrams

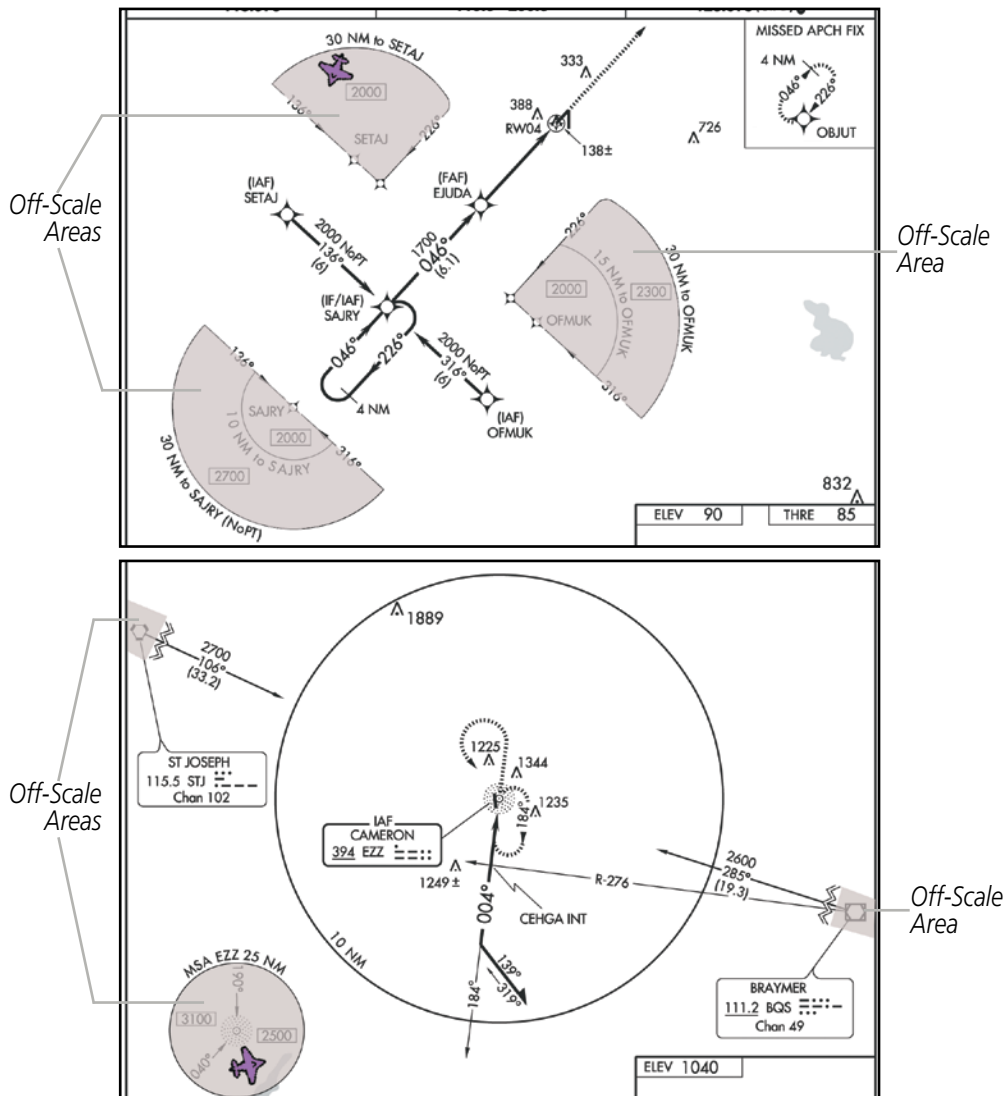

Figure 8-49 Sample Chart Indicating Off-Scale Areas



NOTE: Do not maneuver the aircraft based solely upon the geo-referenced aircraft symbol.

FLITECHARTS SOFTKEYS

FliteCharts functions are displayed on three levels of softkeys. While on the Navigation Map Page, Nearest Airports Page, or Flight Plan Page, pressing the **SHW CHRT** Softkey displays the available terminal chart and advances to the chart selection level of softkeys: **CHRT OPT**, **CHRT**, **INFO**, **DP**, **STAR**, **APR**, **WX**, and **GO BACK**. The chart selection softkeys appear on the Airport Information Page.

Pressing the **GO BACK** Softkey reverts to the top level softkeys and previous page.

Pressing the **CHRT OPT** Softkey displays the available terminal chart and advances to the next level of softkeys: **ALL**, **FIT WDTN**, **FULL SCN**, and **BACK**.

While viewing the **CHRT OPT** Softkeys, after 45 seconds of softkey inactivity, the system reverts to the chart selection softkeys.

NOTAMs are not available with FliteCharts. The NOTAM Softkey label appears subdued and is disabled.

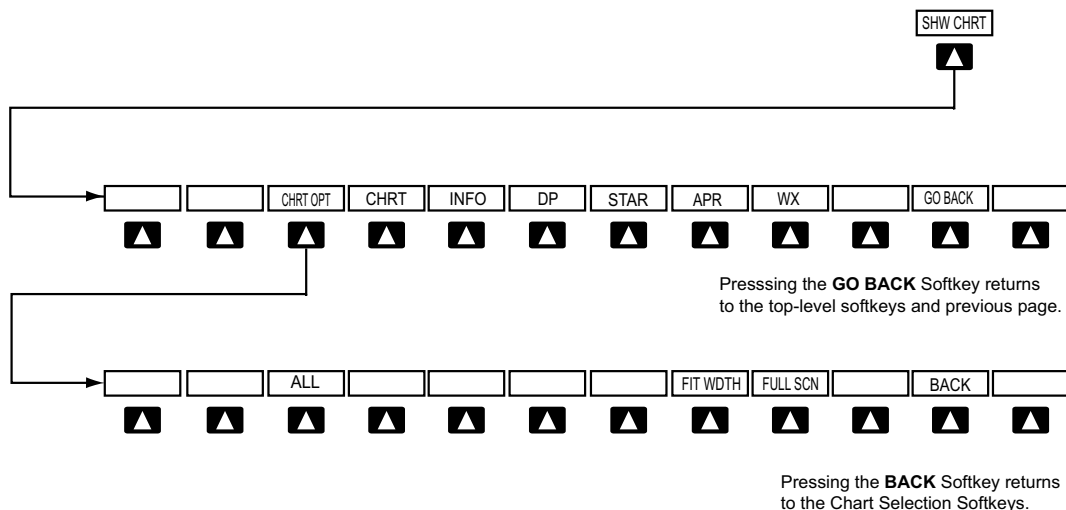

Figure 8-50 FliteCharts SHW CHRT, Chart Selection, and Chart Option Softkeys

TERMINAL PROCEDURES CHARTS

Selecting Terminal Procedures Charts:

While viewing the Navigation Map Page, Nearest Airport Page, or Flight Plan Page, press the **SHW CHRT** Softkey.

Or:

- 1) Press the **MENU** Key to display the PAGE MENU.
- 2) Turn the large **FMS** Knob to scroll through the OPTIONS Menu to Show Chart.
- 3) Press the **ENT** Key to display the chart.



Navigation Map Page OPTIONS Menu

Waypoint Airport Information Page OPTIONS Menu

Figure 8-51 Option Menus

When no terminal procedure chart is available, the banner CHART NOT AVAILABLE appears on the screen. The CHART NOT AVAILABLE banner does not refer to the FliteCharts subscription, but rather the availability of a particular airport chart selection or procedure for a selected airport.



Figure 8-52 Chart Not Available Banner

If there is a problem in rendering the data (such as a data error or a failure of an individual chart), the banner UNABLE TO DISPLAY CHART is then displayed.



Figure 8-53 Unable To Display Chart Banner

When a chart is not available by pressing the **SHW CHRT** Softkey or selecting a Page Menu Option, charts may be obtained for other airports from the WPT Pages or Flight Plan Pages.

If a chart is available for the destination airport, or the airport selected in the active flight plan, the chart appears on the screen. When no flight plan is active, or when not flying to a direct-to destination, pressing the **SHW CHRT** Softkey displays the chart for the nearest airport, if available.

The chart shown is one associated with the WPT – Airport Information page. Usually this is the airport runway diagram. Where no runway diagram exists, but Take Off Minimums or Alternate Minimums are available, that page appears. If Airport Information pages are unavailable, the Approach Chart for the airport is shown.

Selecting a chart:

- 1) While viewing the Navigation Map Page, Flight Plan Page, or Nearest Airports Page, press the **SHW CHRT** Softkey. The airport diagram or approach chart is displayed on the Airport Information Page.
- 2) Push the **FMS** Knob to activate the cursor.
- 3) Turn the large **FMS** Knob to select either the Airport Identifier Box or the Approach Box. (Press the **APR** Softkey if the Approach Box is not currently shown).
- 4) Turn the small and large **FMS** Knob to enter the desired airport identifier.
- 5) Press the **ENT** Key to complete the airport selection.
- 6) Turn the large **FMS** Knob to select the Approach Box.
- 7) Turn the small **FMS** Knob to show the approach chart selection choices.
- 8) Turn either **FMS** Knob to scroll through the available charts.
- 9) Press the **ENT** Key to complete the chart selection.

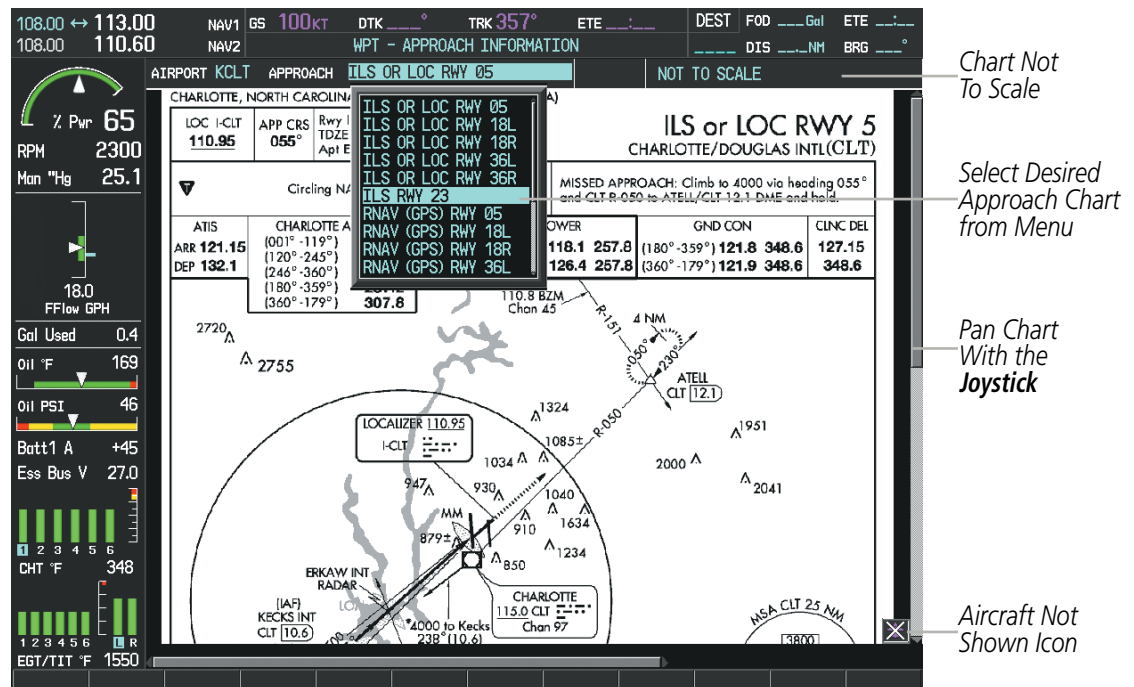

Figure 8-54 Approach Information Page, Chart Selection

While the **APPROACH** Box is selected using the **FMS** Knob, the MFD softkeys are blank. Once the desired chart is selected, the chart scale can be changed and the chart can be panned using the **Joystick**. Pressing the **Joystick** centers the chart on the screen.

The aircraft symbol is not shown on FliteCharts. The Chart Scale Box displays a banner **NOT TO SCALE**, and the Aircraft Not Shown Icon is displayed in the lower right corner of the screen.

Pressing the **CHRT** Softkey alternates between the FliteCharts diagram and the associated map in the WPT page group. In the example shown, the **CHRT** Softkey switches between the Charlotte, NC (KCLT) Airport Diagram and the navigation map on the WPT – Airport Information page.

- SYSTEM OVERVIEW
- FLIGHT INSTRUMENTS
- EIS
- AUDIO PANEL & CNS
- FLIGHT MANAGEMENT
- HAZARD AVOIDANCE
- AFCS
- ADDITIONAL FEATURES
- APPENDICES
- INDEX



Figure 8-55 CHRT Softkey, Airport Information Page

Pressing the **INFO-1** or **INFO-2** Softkey returns to the airport diagram chart when the view is on a terminal procedure chart. If the displayed chart is the airport diagram chart, pressing the **INFO-1** or **INFO-2** Softkey returns to the Airport Information Page.

Another source for additional airport information is from the INFO Box above the chart (Figure 8-59) or to the right of the chart (Figure 8-55) for certain airports. This information source is not related to the **INFO-1** or **INFO-2** Softkey. When the INFO Box is selected using the **FMS** Knob, the MFD softkeys are blank. The Charlotte, NC airport has three additional charts offering information; the Airport Diagram, Alternate Minimums, and Take-off Minimums.

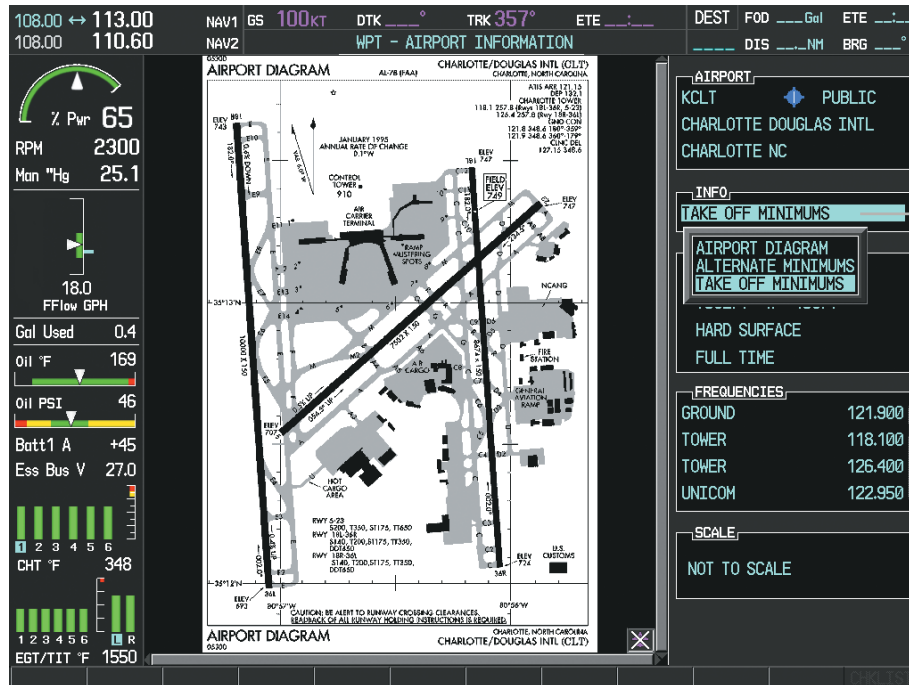

Figure 8-56 Airport Information Page, INFO View with Airport Information

In the example shown in Figure 8-57, TAKE OFF MINIMUMS is selected. Pressing the ENT Key displays the Take-off Minimums and Departure Procedures Chart (Figure 8-58).

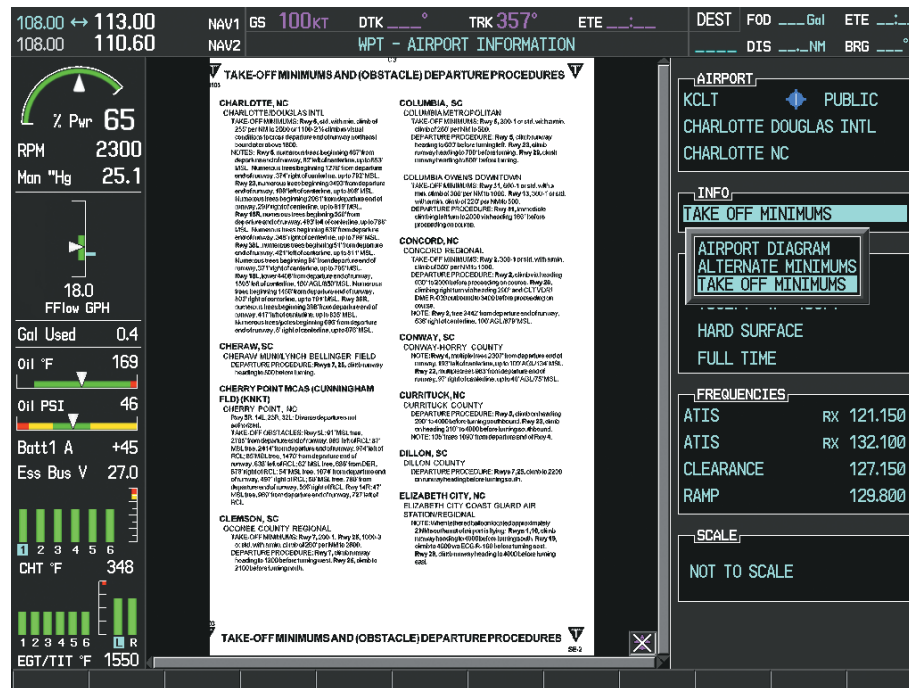

Figure 8-57 Airport Information Page, TAKE OFF MINIMUMS Selected from INFO View

Pressing the **DP** Softkey displays the Departure Procedure Chart if available.

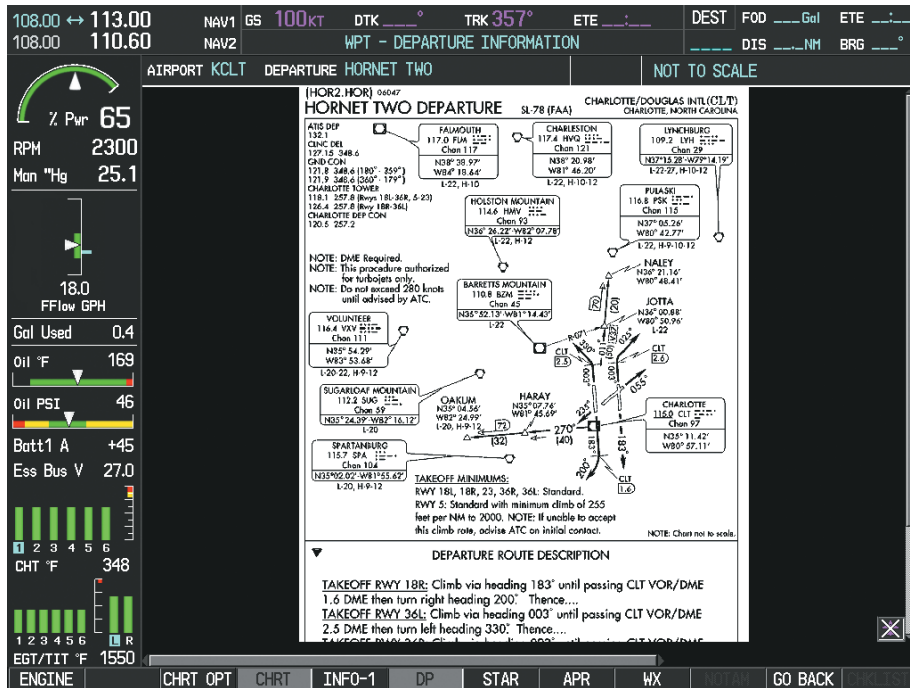

Figure 8-58 Departure Information Page

Pressing the **STAR** Softkey displays the Standard Terminal Arrival Chart if available.

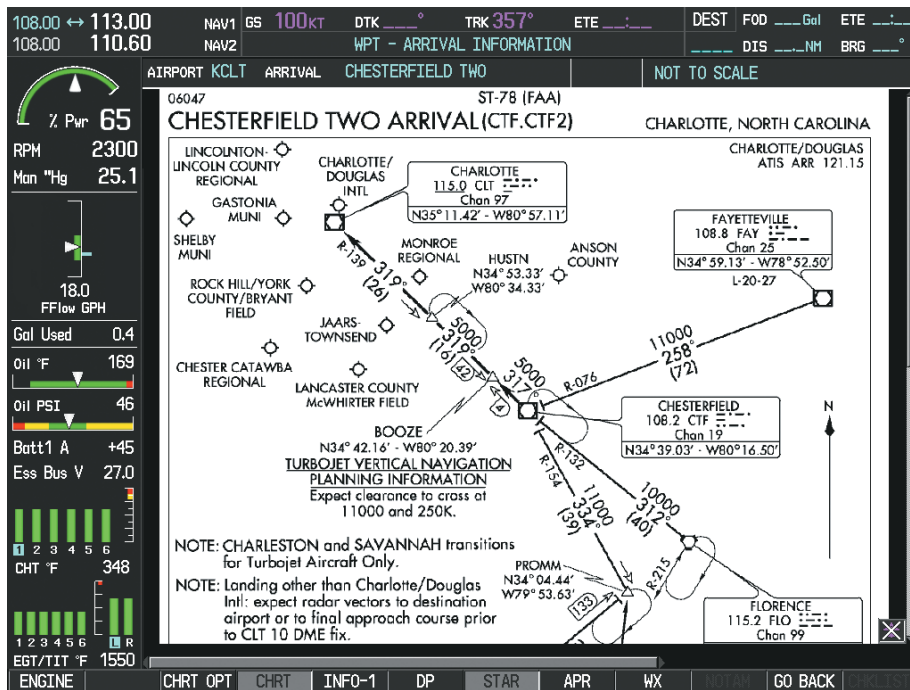

Figure 8-59 Arrival Information Page

Pressing the **APR** Softkey displays the approach chart for the airport if available.

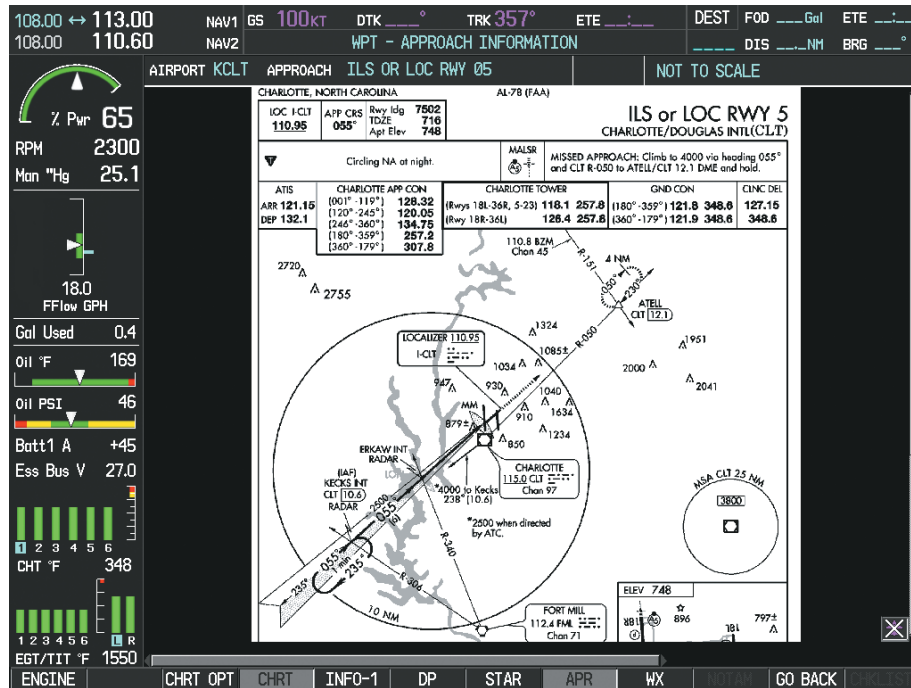

Figure 8-60 Approach Information Page

Pressing the **WX** Softkey shows the airport weather frequency information, when available, and includes weather data such as METAR and TAF from the XM Data Link Receiver. Weather information is available only when an XM Data Link Receiver is installed and the SiriusXM Weather subscription is current.

Selecting Additional Information:

- 1) While viewing the Airport Taxi Diagram, press the **WX** Softkey to display the information windows (AIRPORT, INFO).
- 2) Push the **FMS** Knob to activate the cursor.
- 3) Turn the large **FMS** Knob to highlight the INFO Box.
- 4) Turn the small **FMS** Knob to select the INFO Box choices. When the INFO Box is selected the MFD softkeys are blank. If multiple choices are available, scroll to the desired choice with the large **FMS** Knob and press the **ENT** Key to complete the selection.
- 5) Push the **FMS** Knob again to deactivate the cursor.

- SYSTEM OVERVIEW
- FLIGHT INSTRUMENTS
- EIS
- AUDIO PANEL & CNS
- FLIGHT MANAGEMENT
- HAZARD AVOIDANCE
- AFCS
- ADDITIONAL FEATURES
- APPENDICES
- INDEX

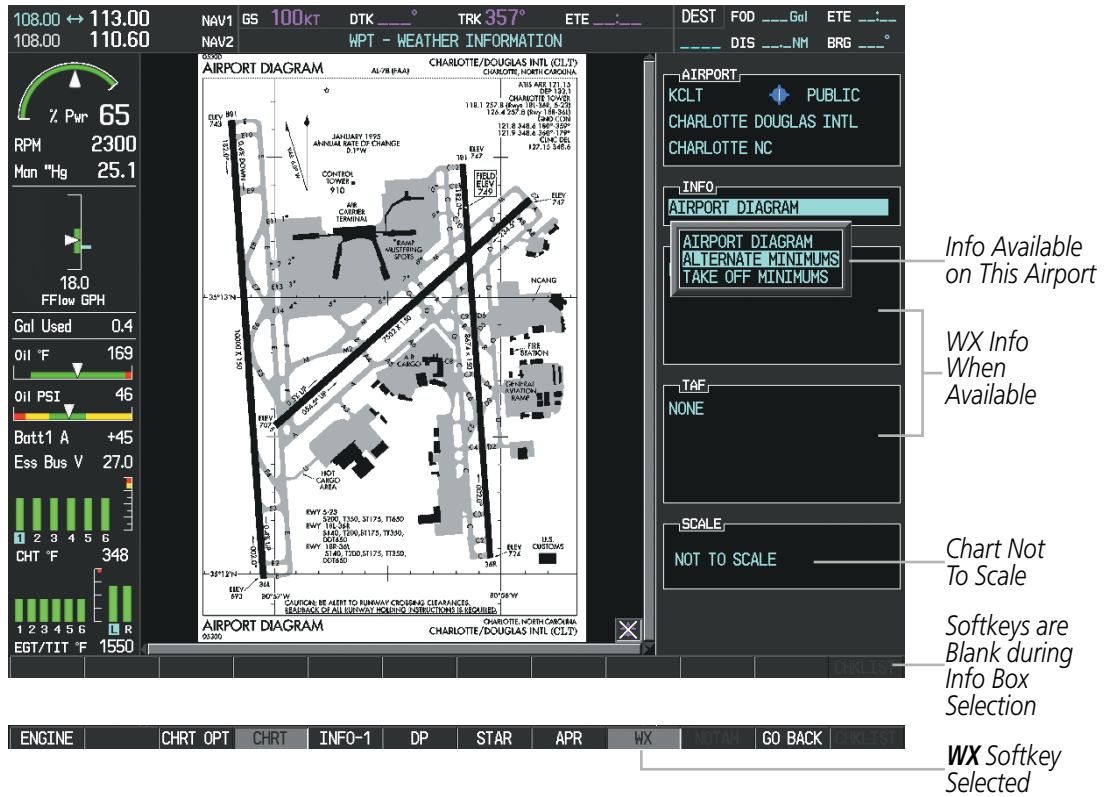
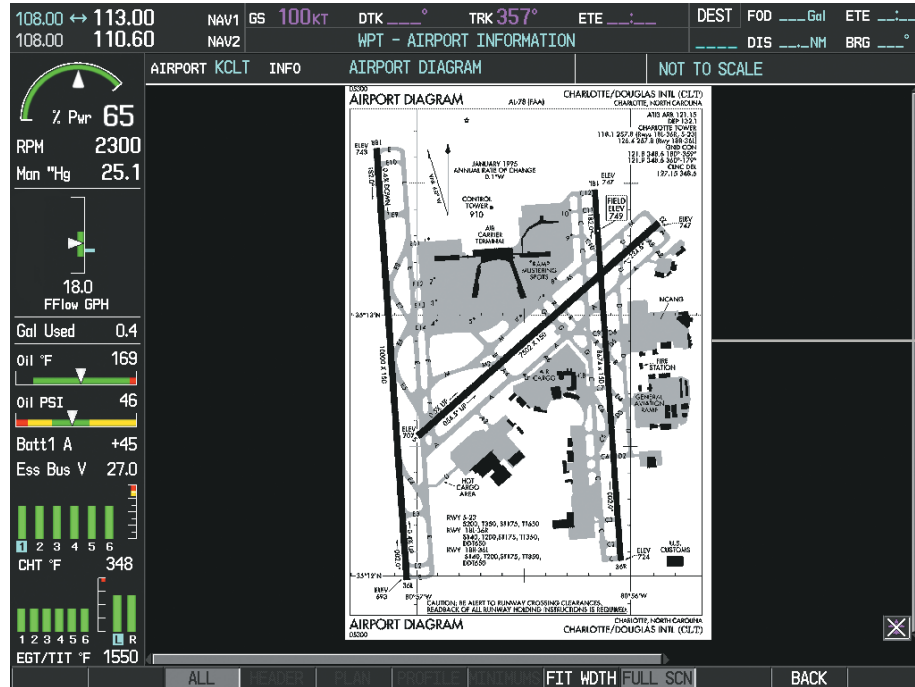

Figure 8-61 Weather Information Page, WX Softkey Selected

Pressing the **GO BACK** Softkey reverts to the previous page (Navigation Map Page or Flight Plan Page).

CHART OPTIONS

Pressing the **CHRT OPT** Softkey displays the next level of softkeys, the chart options level (Figure 8-63). Pressing the **ALL** Softkey shows the complete chart on the screen.



Complete Chart Shown

Figure 8-62 Airport Information Page, ALL View Selected

Pressing the **FIT WIDTH** Softkey fits the width of the chart in the display viewing area. In the example shown, the chart at close range is replaced with the full width chart.

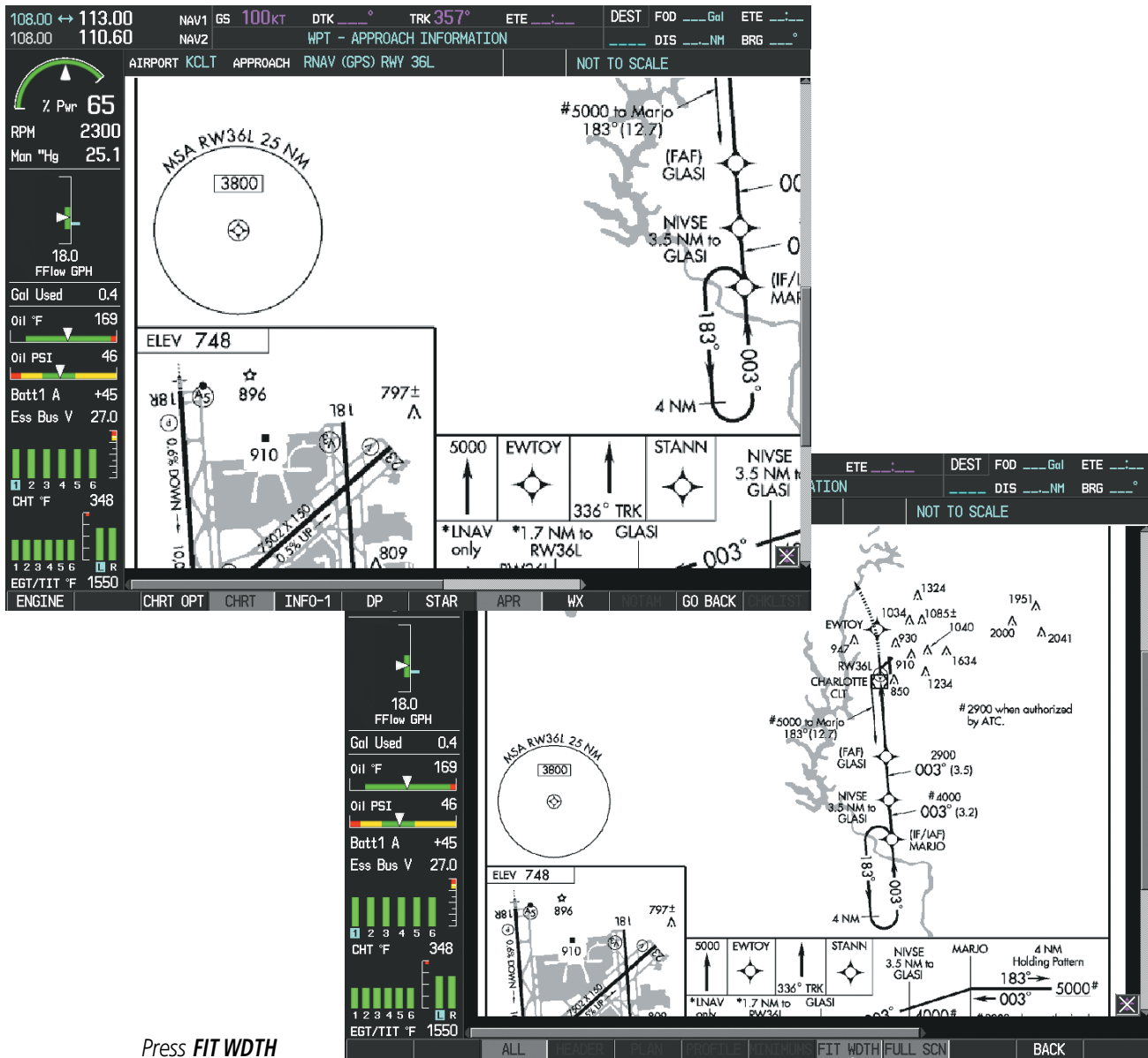

Figure 8-63 Approach Information Page, FIT WIDTH Softkey Selected

Pressing the **FULL SCN** Softkey alternates between removing and replacing the data window to the right.



Figure 8-64 Airport Information Page, Full Screen and Info Window

Pressing the **BACK** Softkey, or waiting for 45 seconds reverts to the chart selection softkeys.

The full screen view can also be selected by using the page menu option.

Selecting full screen On or Off:

- 1) While viewing a terminal chart press the **MENU** Key to display the Page Menu OPTIONS.
- 2) Turn the large **FMS** Knob to highlight the Chart Setup Menu Option and press the **ENT** Key.
- 3) Turn the large **FMS** Knob to move between the FULL SCREEN and COLOR SCHEME Options.
- 4) Turn the small **FMS** Knob to choose between the On and Off Full Screen Options.

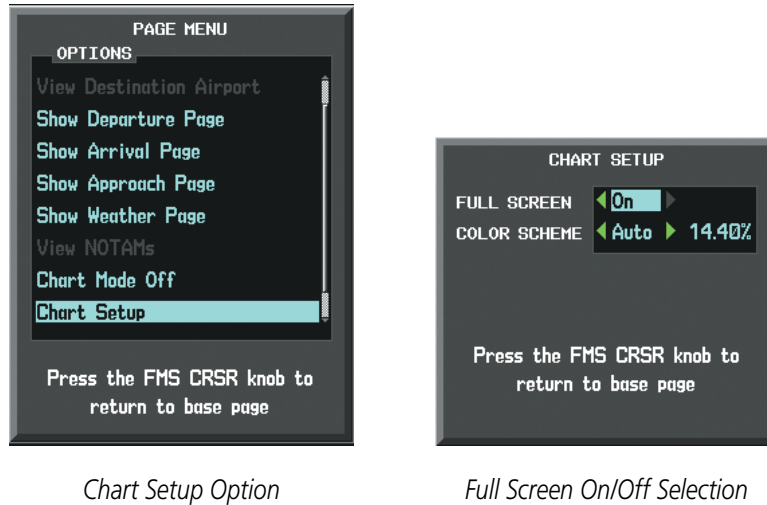

Chart Setup Option

Full Screen On/Off Selection

Figure 8-65 Page Menus

DAY/NIGHT VIEW

FliteCharts can be displayed on a white or black background for day or night viewing. The Day View offers a better presentation in a bright environment. The Night View gives a better presentation for viewing in a dark environment. When the CHART SETUP Box is selected the MFD softkeys are blank.

Selecting Day, Night, or Automatic View:

- 1) While viewing a terminal chart press the **MENU** Key to display the Page Menu OPTIONS.
- 2) Turn the large **FMS** Knob to highlight the Chart Setup Menu Option and press the **ENT** Key.

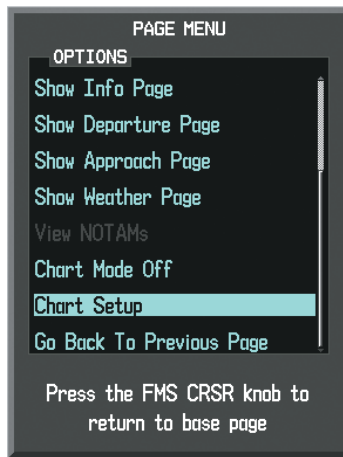

Figure 8-66 Waypoint Information Page, OPTIONS Menu

- 3) Turn the large **FMS** Knob to move to the COLOR SCHEME Option (Figure 8-68).
- 4) Turn the small **FMS** Knob to choose between Day, Auto, and Night Options.
- 5) If Auto Mode is selected, turn the large **FMS** Knob to select the percentage field. Use the small **FMS** Knob to change the percentage value. The percentage value is the day/night crossover point based on the percentage of

backlighting intensity. For example, if the value is set to 15%, the day/night display changes when the display backlight reaches 15% of full brightness.

The display must be changed in order for the new setting to become active. This may be accomplished by selecting another page or changing the display range.

- 6) Push the **FMS** Knob when finished to remove the Chart Setup Menu.

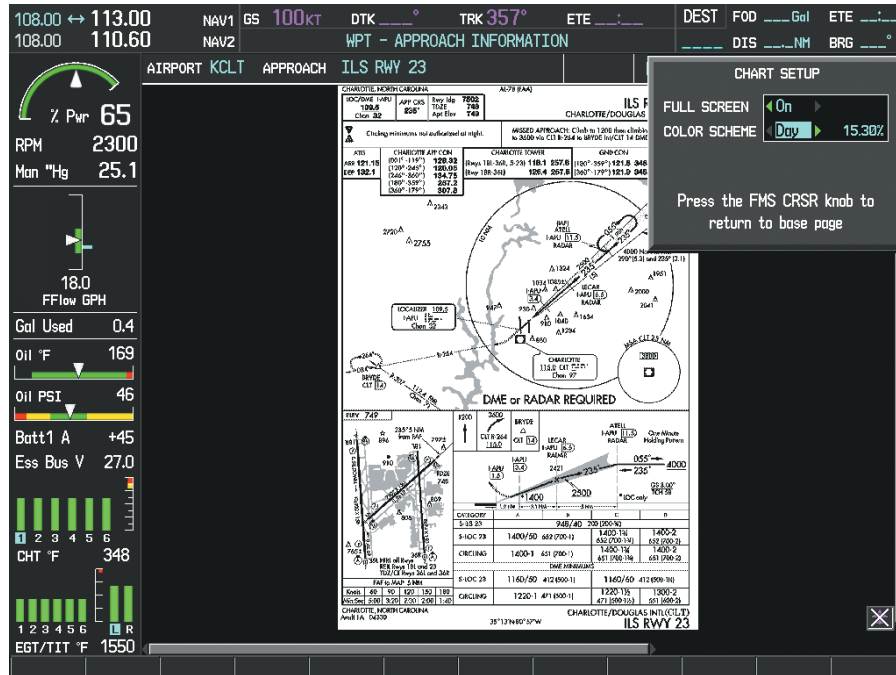

Figure 8-67 Approach Information Page, Day View

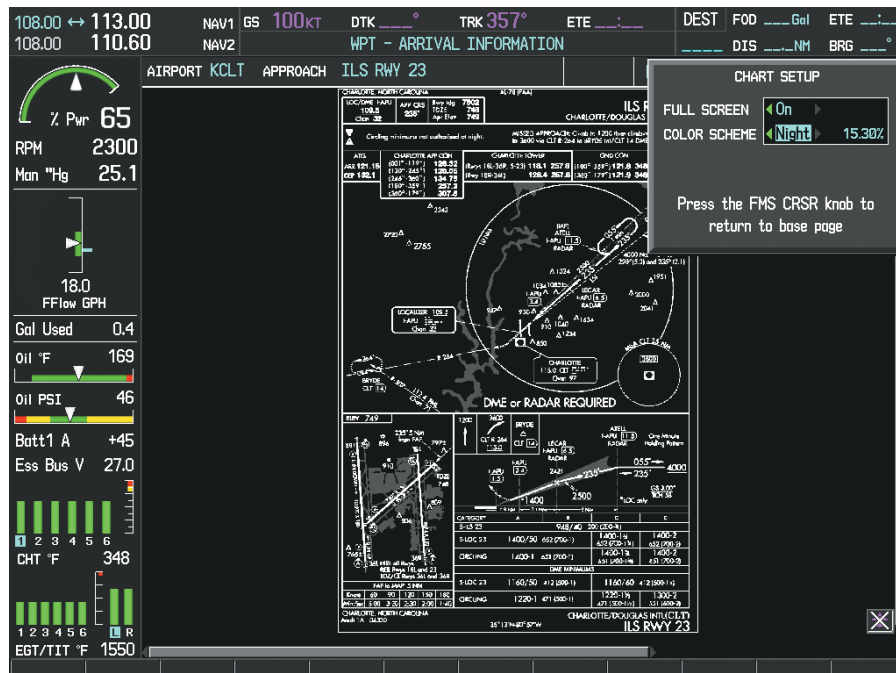

Figure 8-68 Approach Information Page, Night View

8.6 AIRPORT DIRECTORY

The Aircraft Owners and Pilots Association (AOPA) and optional AC-U-KWIK Airport Directory databases offer detailed information regarding services, hours of operation, lodging options, and more. This information is viewed on the Airport Information Page by selecting the INFO Softkey until **INFO-2** is displayed as shown in Figure 8-69.

Both Airport Directories are available for downloading at flygarmin.com. However, copy only one of the databases to the Supplemental Data Card. The system cannot recognize both databases simultaneously.

Selecting the Airport Directory Page:

- 1) Turn the large **FMS** Knob to select the 'WPT' page group.
- 2) Turn the small **FMS** Knob to select the AIRPORT INFORMATION Page. Initially, information for the airport closest to the aircraft's present position is displayed.
- 3) If necessary, select the INFO softkey until **INFO-2** is displayed.



Figure 8-69 AOPA Information on the Airport Information Page

8.7 DATABASE CYCLE NUMBER AND REVISIONS

CYCLE NUMBER AND REVISION

Databases that may be available include FliteCharts, Obstacle, Terrain, IFR/VFR, Navigation, ChartView, SafeTaxi, Airport Directory. Data is revised and expiration dates vary. Data is still viewable during a period that extends from the cycle expiration date to the disables date. When turning on the system, the Power-up Page displays the current status of the databases. As an example, see the table below for the various FliteCharts Power-up Page displays and the definition of each. The expiration date and disables date varies for each database.





Example Power-up Page Display Text	
	FliteCharts Data: N/A
	FliteCharts Data: Expires DD-MMM-YYYY
	FliteCharts Data: Disables DD-MMM-YYYY
	FliteCharts Data: Disabled

Table 8-1 Database Power-up Page Annunciations

White text, such as ‘FliteCharts Data Expires’ plus a date, indicates the chart database is current. Yellow text, such as ‘Chart data is out of date!’ or ‘FliteCharts Data: Disabled”, indicates charts are no longer viewable and have expired.

Database time critical information can also be found on the ‘Aux - System Status’ page. The database Region, Cycle number, Effective, Expires, and Disables dates of the subscription appear in either blue or yellow text. Dates shown in blue are current data. Dates shown in yellow indicate the data is not within the current subscription period.



NOTE: A subdued softkey label indicates the function is disabled.

From the ‘Aux - System Status’ Page, push the **MFD1 DB** Softkey to place the cursor in the Database window. Scroll through the listed information by turning the **FMS** Knob or pushing the **ENT** Key until the applicable database information is shown.

Database cycle numbers are in a format such as YYTI or YYII, which are deciphered as follows:

YYTI

YY – Indicates the last two digits of the year (ex. 18 represents 2018)

T – Indicates the database type (ex. S is for SafeTaxi, D is for Airport Directory)

I – Indicates the numerical issue of the database for the year (ex. 5 is the fifth issue of the year)

YYII

YY – Indicates the last two digits of the year (ex. 18 represents 2018)

II – Indicates the numerical issue of the database for the year (ex. 05 is the fifth issue of the year)

Refer to Updating Garmin Databases in Appendix for instructions on revising databases.









Example Power-up Page Display Text	Database Cycle Number Format	Revision Cycle
 Navigation	YYII	28 days
 Basemap Land	YYMI	Not Applicable
 Terrain	YYTI	Not Applicable
 Obstacle	YYBI	56 days
 SafeTaxi	YYSI	56 days
 Airport Directory	YYDI	56 days
 FliteCharts	YYII	28 days
 ChartView	YYII	14 days
 IFR/VFR Charts	YYII	28 days

Table 8-2 Database Startup, Format and Cycle

8.8 SIRIUSXM SATELLITE RADIO ENTERTAINMENT



NOTE: Refer to the Hazard Avoidance Section for information about SiriusXM Weather products.

The optional SiriusXM Satellite Radio entertainment feature of the GDL 69A Data Link Receiver is available for the pilot's and passengers' enjoyment. The GDL 69A can receive SiriusXM Satellite Radio entertainment services at any altitude throughout the Continental U.S. Entertainment audio is available only on the GDL 69A Data Link Receiver, not the GDL 69.

SiriusXM Satellite Radio offers a variety of radio programming over long distances without having to constantly search for new stations. Based on signals from satellites, coverage far exceeds land-based transmissions. SiriusXM Satellite Radio services are subscription-based. For more information on specific service packages, visit www.siriusxm.com.

ACTIVATING SIRIUSXM SATELLITE RADIO SERVICES

The service is activated by providing SiriusXM Satellite Radio with either one or two coded IDs, depending on the equipment. Either the Audio Radio ID or the Data Radio ID, or both, must be provided to SiriusXM Satellite Radio to activate the entertainment subscription.

It is not required to activate both the entertainment and weather service subscriptions with the GDL 69A. Either or both services can be activated. SiriusXM Satellite Radio uses one or both of the coded IDs to send an activation signal that, when received by the GDL 69A, allows it to play entertainment programming.

These IDs are located:

- On the label on the back of the Data Link Receiver
- On the XM Information Page on the MFD (Figure 8-70)
- On the XM Satellite Radio Activation Instructions included with the unit (available at www.garmin.com, P/N 190-00355-04)

Contact the installer if the Data Radio ID and the Audio Radio ID cannot be located.



NOTE: The **LOCK** Softkey on the XM Information Page (AUX Page Group) is used to save GDL 69A activation data when the SiriusXM services are initially set up. It is not used during normal SiriusXM Satellite Radio operation, but there should be no adverse effects if inadvertently pressed during flight. Refer to the GDL 69/69A XM Satellite Radio Activation Instructions (190-00355-04, Rev K or later) for further information.

Activating the SiriusXM Satellite Radio services:

- 1) Contact Sirius XM Radio Inc. Follow the instructions provided by SiriusXM Satellite Radio services.
- 2) Select the AUX Page Group.
- 3) Select the next to last page in the AUX Page Group.
- 4) Press the **INFO** Softkey to display the XM Information Page.
- 5) Verify the desired services are activated.

- 6) Press the **LOCK** Softkey.
- 7) Turn the large **FMS** Knob to highlight YES.
- 8) To complete activation, press the **ENT** Key.

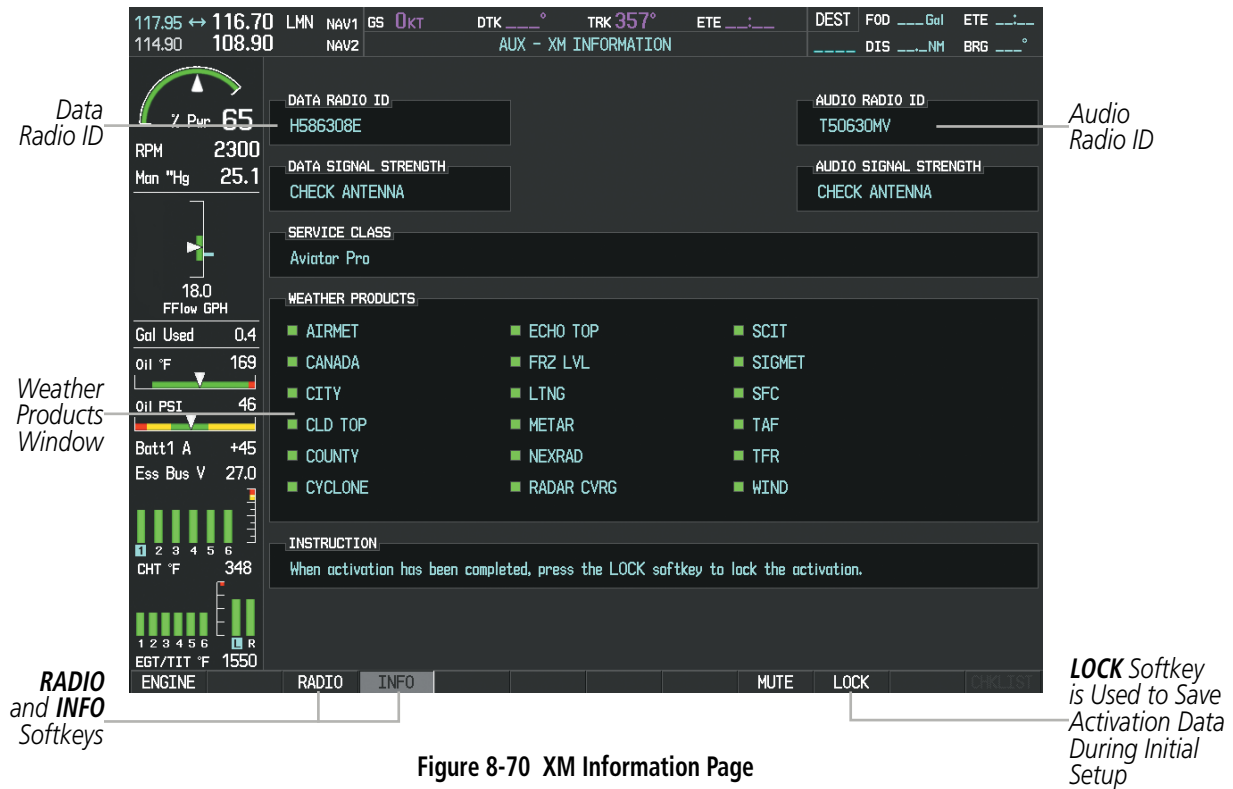

Figure 8-70 XM Information Page

If SiriusXM Weather services have not been activated, all the weather product boxes are blank on the XM Information Page and a yellow Activation Required message is displayed in the center of the Weather Data Link Page (Map Page Group). The Service Class refers to the groupings of weather products available for subscription.

USING SIRIUSXM RADIO

The XM Radio Page provides information and control of the audio entertainment features of the SiriusXM Satellite Radio.

Selecting the XM Radio Page:

- 1) Turn the large **FMS** Knob to select the AUX Page Group.
- 2) Turn the small **FMS** Knob to select the displayed AUX - XM Information Page.
- 3) Press the **RADIO** Softkey to show the XM Radio Page where audio entertainment is controlled.



Figure 8-71 XM Radio Page

ACTIVE CHANNEL AND CHANNEL LIST

The Active Channel Box on the XM Radio Page displays the currently selected channel the SiriusXM Satellite Radio is using.

The Channels List Box of the XM Radio Page shows a list of the available channels for the selected category. Channels can be stepped through one at a time or may be selected directly by channel number.

Selecting a channel from the channel list:

- 1) While on the XM Radio Page, press the **CHNL** Softkey.
- 2) Press the **CH +** Softkey to go up through the list in the Channel Box, or move down the list with the **CH –** Softkey.

Or:

- 1) Push the **FMS** Knob to highlight the channel list and turn the large **FMS** Knob to scroll through the channels.
- 2) Press the **ENT** Key to activate the selected channel.

Selecting a channel directly:

- 1) While on the XM Radio Page, press the **CHNL** Softkey.
- 2) Press the **DIR CH** Softkey. The channel number in the Active Channel Box is highlighted.
- 3) Press the numbered softkeys located on the bottom of the display to directly select the desired channel number.
- 4) Press the **ENT** Key to activate the selected channel.

CATEGORY

The Category Box of the XM Radio Page displays the currently selected category of audio. Categories of channels such as jazz, rock, or news can be selected to list the available channels for a type of music or other contents. One of the optional categories is PRESETS to view channels that have been programmed.

Selecting a category:

- 1) Press the **CATGRY** Softkey on the XM Radio Page.
- 2) Press the **CAT +** and **CAT -** Softkeys to cycle through the categories.

Or:

Turn the small **FMS** Knob to display the Categories list. Highlight the desired category with the small **FMS** Knob and press the **ENT** Key. Selecting All Categories places all channels in the list.



Figure 8-72 Categories List

PRESETS

Up to 15 channels from any category can be assigned a preset number. The preset channels are selected by pressing the **PRESETS** and **MORE** Softkeys. Then the preset channel can be selected directly and added to the channel list for the Presets category.

Setting a preset channel number:

- 1) On the XM Radio Page, while listening to an Active Channel that is wanted for a preset, press the **PRESETS** Softkey to access the first five preset channels (**PS1 - PS5**).
- 2) Press the **MORE** Softkey to access the next five channels (**PS6 – PS10**), and again to access the last five channels (**PS11 – PS15**). Pressing the **MORE** Softkey repeatedly cycles through the preset channels.
- 3) Press any one of the (**PS1 - PS15**) softkeys to assign a number to the active channel.
- 4) Press the **SET** Softkey on the desired channel number to save the channel as a preset.

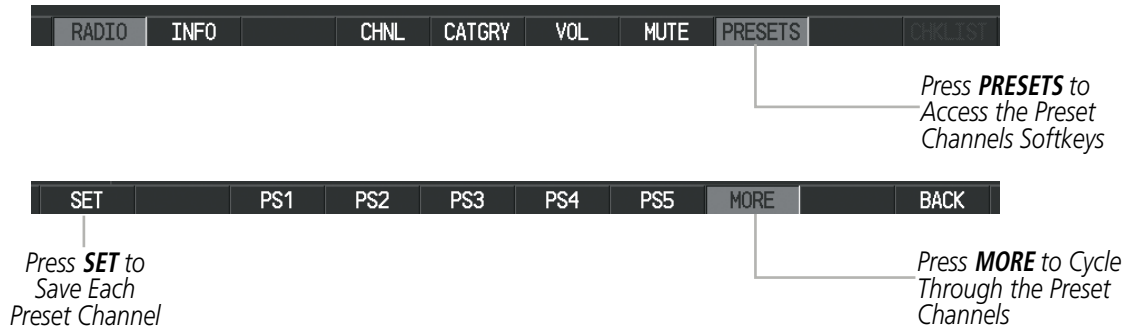

Figure 8-73 Accessing and Selecting XM Preset Channels

Pressing the **BACK** Softkey, or 45 seconds of softkey inactivity, returns the system to the top level softkeys.

VOLUME

Radio volume is shown as a percentage of full volume. Volume level is controlled by pressing the **VOL** Softkey, which brings up the volume increase and decrease softkeys.

Adjusting the volume:

- 1) With the XM Radio Page displayed, press the **VOL** Softkey.
- 2) Press the **VOL -** Softkey to reduce volume or press the **VOL +** Softkey to increase volume. (Once the **VOL** Softkey is pressed, the volume can also be adjusted using the small **FMS** Knob.)



Figure 8-74 Volume Control

Mute SiriusXM audio:

- 1) Select the XM Radio Page or XM Information Page.
- 2) Press the **MUTE** Softkey to mute the audio. Press the **MUTE** Softkey again to unmute the audio.

8.9 SATELLITE TELEPHONE & SMS MESSAGING SERVICE

The optional GSR 56 Iridium Transceiver provides global airborne Iridium Satellite Telephone and SMS messaging service. The telephone audio is provided through the audio panel and headset. Operation is accomplished through the AUX-AUXILIARY COMMUNICATIONS Pages.

NOTE: *Garmin is not responsible for communication problems when using Iridium satellite services. Services may be affected by poor signal strength, satellite health, and the availability of responding agencies when emergency services are required.*

NOTE: *Use of emergency telephone services through Iridium Communications, Inc. is not a substitute for following proper aviation emergency procedures and communications.*

Emergency communications are provided by Iridium Communications Inc. when the aircraft is operating within the United States, Puerto Rico, and the U.S. Virgin Islands. Making a telephone call by dialing "911" will contact a third party Emergency Call Relay Center (ECRC).

REGISTERING THE IRIDIUM SATELLITE SYSTEM

A subscriber account must be established prior to using the Iridium Satellite System. Before setting up an Iridium account, obtain the serial number of the Iridium Transceiver (GSR1) and the System ID by selecting the AUX- SYSTEM STATUS Page as shown in Figure 8-75. Contact Garmin Flight Data Services online at <https://fly.garmin.com/fly-garmin/support/applications/satelliteservices/>.

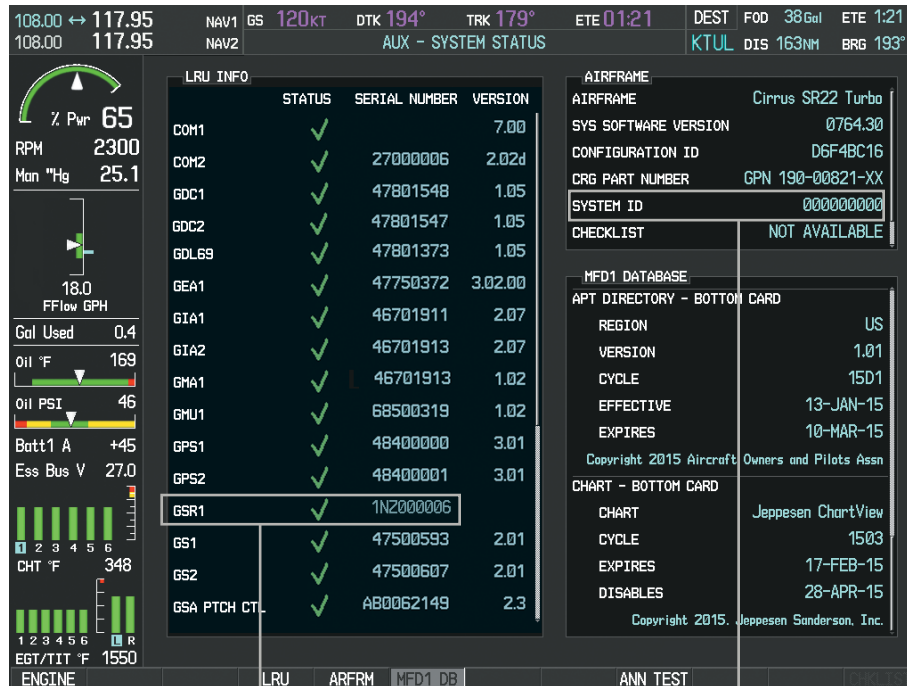

Iridium Transceiver Serial Number

System ID Number

Figure 8-75 Identification Needed for Iridium Registration

TELEPHONE COMMUNICATION

The pilot or copilot can place and answer calls on the Iridium satellite network. Control and monitoring of telephone functions are accomplished through the AUX-TELEPHONE Page.

To view the Telephone Page:

- 1) Turn the large **FMS** Knob on the MFD to select the AUX page group.
- 2) Turn the small **FMS** Knob to select the AUX-TELEPHONE Page.

The PHONE STATUS display, as shown in Figure 8-76, gives a graphical representation of the current disposition of the connection with the Iridium network. Table 8-5 describes symbology used on PHONE STATUS display.

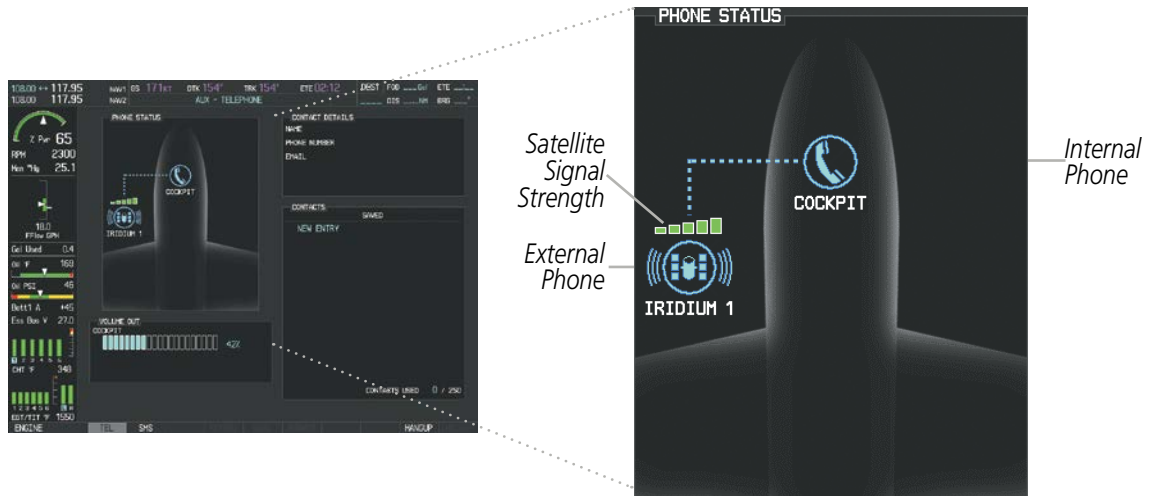

Figure 8-76 Phone Status Display

ENABLE/DISABLE THE IRIDIUM TELEPHONE SYSTEM

The Iridium Satellite Telephone System may be turned on or off by using the page menu.

To enable the Iridium telephone system:

- 1) With the AUX-TELEPHONE Page displayed, select the **MENU** Key on the MFD to display the Page Menu.
- 2) Turn either **FMS** Knob to place the cursor on 'Enable Iridium Transmission'.
- 3) Press the **ENT** Key.

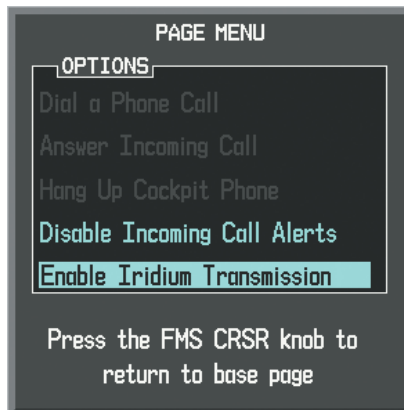

Figure 8-77 Enable Iridium Telephone System

To disable the Iridium telephone system:

- 1) With the AUX-TELEPHONE Page displayed, select the **MENU** Key on the MFD to display the Page Menu.
- 2) Turn either **FMS** Knob to place the cursor on 'Disable Iridium Transmission'.
- 3) Press the **ENT** Key.



















Internal Phone	External Phone	Description
		Phone is Idle
		Phone is ringing
		Phone has a dial tone (off hook) or connected to another phone
		Phone dialed is busy
		Phone is dialing another phone
		Phone has failed
		Phone status not known
		Phone is disabled
		Phone is reserved for data transmission
		Calling other phone or incoming call from other phone
		Other phone is on hold
		Phones are connected

Table 8-3 Telephone Symbols

CONTACTS

The names, telephone number, and email addresses can be saved in a list of contacts for easy use when making telephone calls.

Entering a new contact:

- 1) With the AUX-TELEPHONE Page displayed, push the **FMS** Knob to display the cursor.
- 2) If necessary, turn either **FMS** Knob to place the cursor on 'NEW ENTRY' as shown in Figure 8-78.



Figure 8-78 Select 'NEW ENTRY'

- 3) Press the **ENT** Key. The cursor moves the 'NAME' field of the 'CONTACT DETAILS' window, as seen in Figure 8-79.

- SYSTEM OVERVIEW
- FLIGHT INSTRUMENTS
- EIS
- AUDIO PANEL & CNS
- FLIGHT MANAGEMENT
- HAZARD AVOIDANCE
- AFCS
- ADDITIONAL FEATURES
- APPENDICES
- INDEX



Figure 8-79 Enter Contact Name

- 4) Enter the desired name of the new contact. Entry can be accomplished through the alphanumeric keys on the MFD Controller, or the **FMS** Knobs on the controller or the MFD.
- 5) Press the **ENT** Key. The cursor moves to the 'PHONE NUMBER' field.
- 6) Enter the desired telephone number as shown in Figure 8-80. Entry can be accomplished through the alphanumeric keys on the MFD Controller, or the **FMS** Knobs on the controller or the MFD.



Figure 8-80 Enter Contact Phone Number

- 7) Press the **ENT** Key. The cursor moves to the 'EMAIL' field, as in Figure 8-81.



Figure 8-81 Enter Contact Email

- 8) Enter the desired email address. Entry can be accomplished through the alphanumeric keys on the MFD Controller, or the **FMS** Knobs on the controller or the MFD.
- 9) Press the **ENT** Key. The **SAVE** button is highlighted as in Figure 8-82.



Figure 8-82 Save New Contact Entry

- Press the **ENT** Key. The new contact entry is added to the list of saved contacts. See Figure 8-83



Figure 8-83 Contact Shown in List

Delete a contact:

- With the AUX-TELEPHONE Page displayed, push the **FMS** Knob to display the cursor.
- Turn either **FMS** Knob to place the cursor on the desired contact name, as shown in Figure 8-84.



Figure 8-84 Select Contact to be Deleted

- 3) Select the **DELETE** Softkey. A confirmation window is displayed as in Figure 8-85.



Figure 8-85 Confirm Contact Deletion

- 4) With 'OK' highlighted, press the **ENT** Key to delete the selected contact.

Edit a contact:

- 1) With the AUX-TELEPHONE Page displayed, push the **FMS** Knob to display the cursor.
- 2) Turn either **FMS** Knob to place the cursor on the desired contact name, as shown in Figure 8-86.

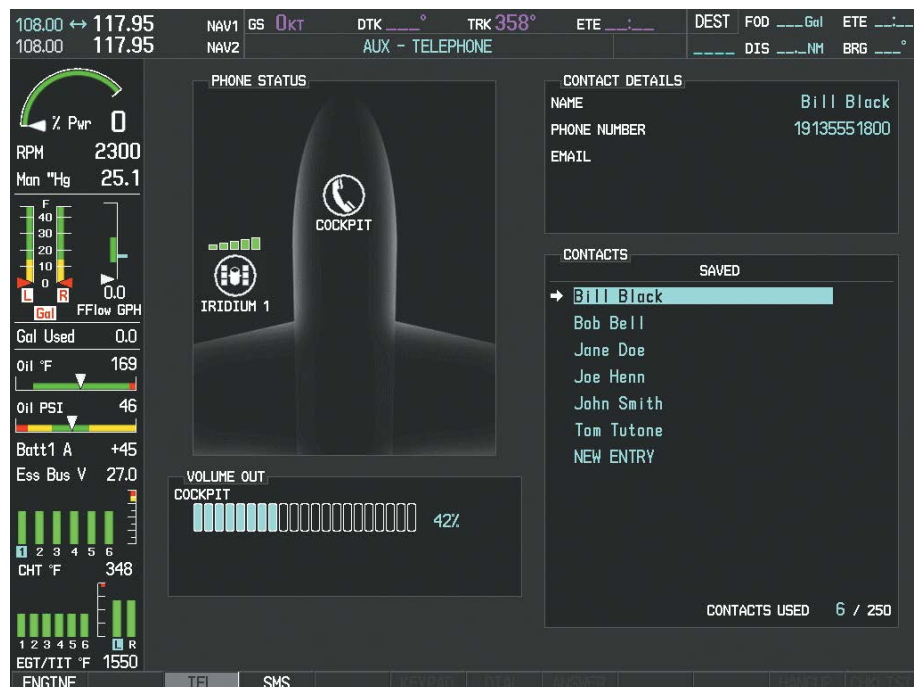

Figure 8-86 Select Contact to be Edited

- 3) Select the **EDIT** Softkey. The cursor is placed in the 'NAME' field, as in Figure 8-87. Enter the desired changes. Entry can be accomplished through the alphanumeric keys on the MFD Controller, or the **FMS** Knobs on the controller or the MFD.



Figure 8-87 Make the Desired Changes

- 4) Press the **ENT** Key when each field is complete. The **SAVE** Button is now highlighted.
- 5) Press the **ENT** Key to save the changes.

INCOMING CALLS



NOTE: Outside callers should dial 00 + 8816 or 8817 + aircraft phone number when calling the aircraft Iridium Telephone System.

When a phone call is received while viewing MFD pages other than the AUX-TELEPHONE Page, a pop-up alert similar to Figure 8-88 is displayed and an aural alert “Incoming Call” is heard. The pop-up alert may be inhibited at times, such as during takeoff. In addition to the pop-up alert, a ringing phone symbol is displayed to the right of the MFD page title as shown in Figure 8-88. Also, the voice alert “Incoming Call” is heard on the selected cockpit audio.

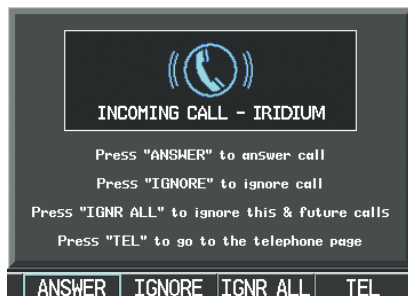

Incoming Call Pop-up



Incoming Call Symbol on MFD Page

Figure 8-88 Incoming Call

Answering an incoming call:

- 1) Press the  Key (GMA 350/350c) or **TEL** Key (GMA 347) on the audio panel.
- 2) Select the **ANSWER** Softkey on the MFD.

Or:

While viewing the AUX-TELEPHONE Page:



NOTE: The Push-to-Talk switch is not utilized for telephone communication. The microphone is active after selecting the **ANSWER** Softkey, and stays active until the call is terminated.

- 1) Press the  Key (GMA 350/350c) or **TEL** Key (GMA 347) on the audio panel.
- 2) Press the **MENU** Key to display the Page Menu.
- 3) Turn either **FMS** Knob to place the cursor on 'Answer Incoming Call'.
- 4) Press the **ENT** Key.

Selecting the **IGNORE** Softkey will extinguish the pop-up window and leave the current call unanswered. Selecting the **IGNRE ALL** Softkey will extinguish the pop-up window for the current and all future incoming calls and leave the current call unanswered. Selecting the **TEL** Softkey will display the AUX-TELEPHONE Page allowing additional call information to be viewed before answering.

Disabling incoming call alerts:

- 1) With the AUX-TELEPHONE Page displayed, press the **MENU** Key on the MFD to display the Page Menu.
- 2) Turn either **FMS** Knob to place the cursor on 'Disable Incoming Call Alerts'.
- 3) Press the **ENT** Key. The voice and pop-up alert will not be displayed now when an incoming call is received.

OUTGOING CALLS

Voice calls can be made from the cockpit to an external phone through the Iridium Satellite Network.



NOTE: The Push-to-Talk switch is not utilized for telephone communication. The microphone is active after selecting the **ANSWER** Softkey, and stays active until the call is terminated.

To make a call:

- 1) Press the  Key (GMA 350/350c) or **TEL** Key (GMA 347) on the audio panel.
- 2) Select the **DIAL** Softkey on the MFD. A display similar to Figure 8-89 will be shown.

Or:

While viewing the AUX-TELEPHONE Page:

- a) Press the  Key (GMA 350/350c) or **TEL** Key (GMA 347) on the audio panel.
- b) Press the **MENU** Key to display the Page Menu.
- c) Turn either **FMS** Knob to place the cursor on 'Dial a Phone Call'.
- d) Press the **ENT** Key.

- SYSTEM OVERVIEW
- FLIGHT INSTRUMENTS
- EIS
- AUDIO PANEL & CNS
- FLIGHT MANAGEMENT
- HAZARD AVOIDANCE
- AFCS
- ADDITIONAL FEATURES
- APPENDICES
- INDEX



Figure 8-89 Initiating a Call

- 3) Enter the desired number string (typically, country code + area code + phone number) by selecting the number softkeys on the MFD, pressing the numeric keys on the PFD/MFD Controller, or turning the **FMS** Knobs. The system may be configured by an authorized repair facility to automatically enter a default country code when the dialing window is displayed. To replace the default country code, move the cursor to the first (furthest left) number in the dialing window and enter the desired country code.
- 4) Press the **ENT** Key. 'OK' is highlighted as in Figure 8-90.



Figure 8-90 Make the Call

- 5) Press the **ENT** Key. The system will begin calling the number, as in Figure 8-91.



Figure 8-91 System is Making the Connection

When the phone is answered, the connection is established as shown in Figure 8-92. To exit the call, select the **HANGUP** Softkey.



Figure 8-92 Phone is Answered, Connection Complete

TEXT MESSAGING (SMS)

The pilot or copilot can send and receive text messages on the Iridium satellite network. Messages may be sent to an email address or text message capable cellular telephone. Message length is limited to 160 characters, including the email address.

Senders should address text messages to the aircraft by entering [aircraft Iridium phone number]@msg.iridium.com.

The text messaging user interface is mainly through the AUX-TEXT MESSAGING Page.

Viewing the Text Messaging Page:

- 1) Turn the large **FMS** Knob on the MFD to select the AUX page group.
- 2) Turn the small **FMS** Knob to select the SATELLITE PHONE.
- 3) If necessary, select the **SMS** Softkey to display the AUX-TEXT MESSAGING Page as shown in Figure 8-93.

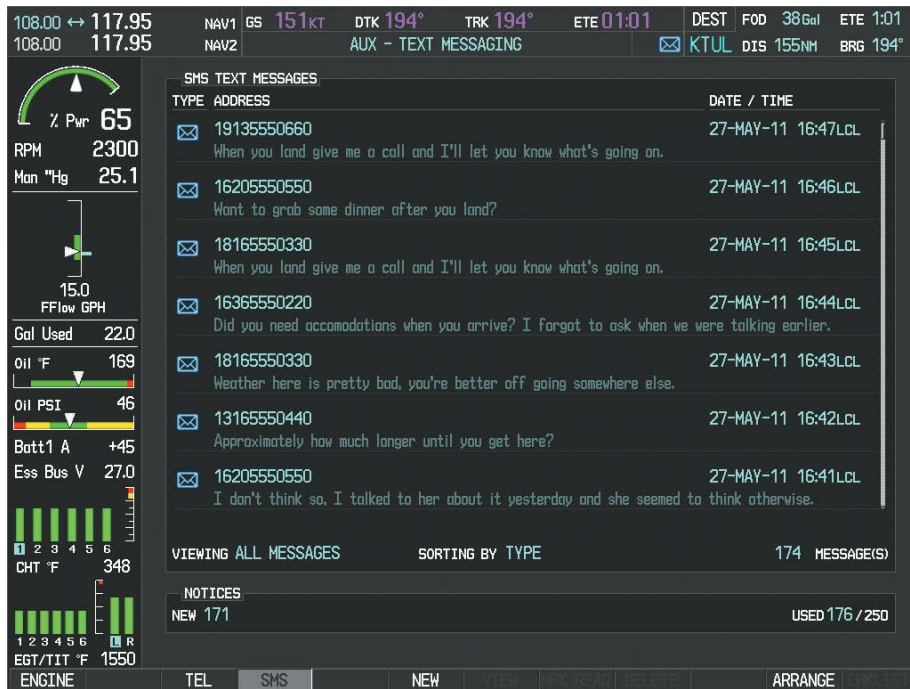

Figure 8-93 Text Messaging Page







Message Symbol	Description
	Received text message that has not been opened
	Received text message that has been opened
	Saved text message, draft not sent
	System is sending text message
	Text message has been sent
	System failed to send text message
	Predefined text message

Table 8-4 Text Message Symbols

VIEWING A TEXT MESSAGE WHEN RECEIVED

When viewing MFD pages other than the AUX-TEXT MESSAGING Page, a pop-up alert similar to Figure 8-94 will be displayed when a new text message is received.



New Text Message Pop-up

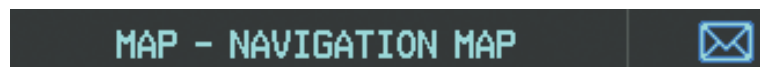

New Text Message Symbol on MFD Page

Figure 8-94 New Text Message Received

Select the **VIEW** Softkey to view the message (Figure 8-95). Selecting the **IGNORE** Softkey will extinguish the pop-up window and leave the text message unopened. Selecting the **IGNR ALL** Softkey will extinguish the pop-window and ignore all future incoming text messages. Selecting the **SMS** Softkey will display the AUX-TEXT MESSAGING Page.

- SYSTEM OVERVIEW
- FLIGHT INSTRUMENTS
- EIS
- AUDIO PANEL & CNS
- FLIGHT MANAGEMENT
- HAZARD AVOIDANCE
- AFCS
- ADDITIONAL FEATURES
- APPENDICES
- INDEX



Figure 8-95 Text Message Displayed from Pop-Up Alert

The pop-up alerts may be enabled or disabled through the Page Menu.

Enabling/disabling incoming text message pop-up alerts:

- 1) With the AUX-TEXT MESSAGING Page displayed, press the **MENU** Key on the MFD to display the Page Menu.
- 2) Turn either **FMS** Knob to place the cursor on 'Disable New Message Popups' or 'Enable New Message Popups'.
- 3) Press the **ENT** Key. The pop-up alert will not be displayed when an incoming text message is received.

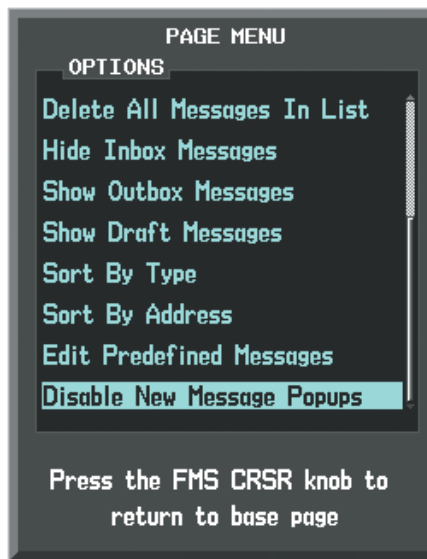

Figure 8-96 Disabling New Text Message Pop-Ups

REPLY TO A TEXT MESSAGE

After reading a text message, a reply may be sent.

Replying to a text message:

While viewing the text message, select the **REPLY** Softkey.

Or:

- 1) Press the **MENU** Key to display the Page Menu.
- 2) Turn either **FMS** Knob to place the cursor on 'Reply To Message'.
- 3) Press the **ENT** Key.

SENDING A TEXT MESSAGE

Text messages may be sent from the AUX-TEXT MESSAGING Page.

Sending a new text message:

- 1) While viewing the AUX-TEXT MESSAGING Page, select the **NEW** Softkey.

Or:

- a) Press the **MENU** Key to display the Page Menu.
 - b) Turn either **FMS** Knob to place the cursor on 'Draft New Message'.
 - c) Press the **ENT** Key.
- 2) The TEXT MESSAGE DRAFT Window is now displayed with the cursor in the 'TO' field. Enter 00 + country code + area code + phone number when sending to a text capable telephone. An email address may also be entered. Entry can be accomplished through the alphanumeric keys on the MFD Controller, or combination of the **FMS** Knob on the controller and softkeys on the MFD. The **FMS** Knob is used to enter letters and numbers, or numbers can be entered from the MFD by selecting the **NUMBERS** Softkey. Select the **CAP LOCK** Softkey to create upper and lower case alpha characters. Special characters can be accessed by selecting the **SYMBOLS** Softkey. See Figure 8-97.
 - 3) Press the **ENT** Key. The cursor is now displayed in the 'MESSAGE' field.

- SYSTEM OVERVIEW
- FLIGHT INSTRUMENTS
- EIS
- AUDIO PANEL & CNS
- FLIGHT MANAGEMENT
- HAZARD AVOIDANCE
- AFCS
- ADDITIONAL FEATURES
- APPENDICES
- INDEX

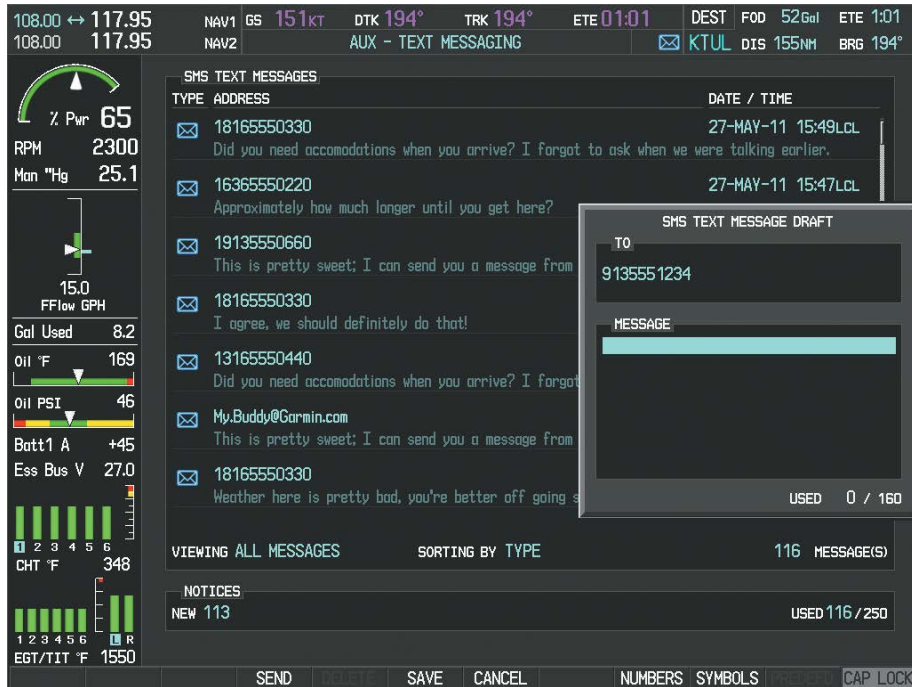

Figure 8-97 Composing a New Text Message

- 4) Enter the desired message using any combination of entry methods as described in step 2.
- 5) Press the **ENT** Key.
- 6) Select the **SEND** Softkey to send the message immediately, or select the **SAVE** Softkey to save the message in Outbox for sending at a later time. Select the **CANCEL** Softkey to delete the message.

PREDEFINED TEXT MESSAGES

Time and effort can be saved in typing text messages that are used repeatedly by saving these messages as a predefined message.

Creating a predefined text message:

- 1) While viewing the AUX-TEXT MESSAGING Page, press the **MENU** Key to display the Page Menu.



Figure 8-98 Creating/Editing Predefined Messages

- 2) Turn either **FMS** Knob to select 'Edit Predefined Messages' as shown in Figure 8-98.
- 3) Press the **ENT** Key. The PREDEFINED MESSAGES view is now displayed.
- 4) Select the **NEW** Softkey.
 - Or:
 - a) Press the **MENU** Key to display the Page Menu.
 - b) Turn either **FMS** Knob to place the cursor on 'Draft New Predefined Message'.
 - c) Press the **ENT** Key. The PREDEFINED SMS TEXT MESSAGE Window is now displayed as shown in Figure 8-99.

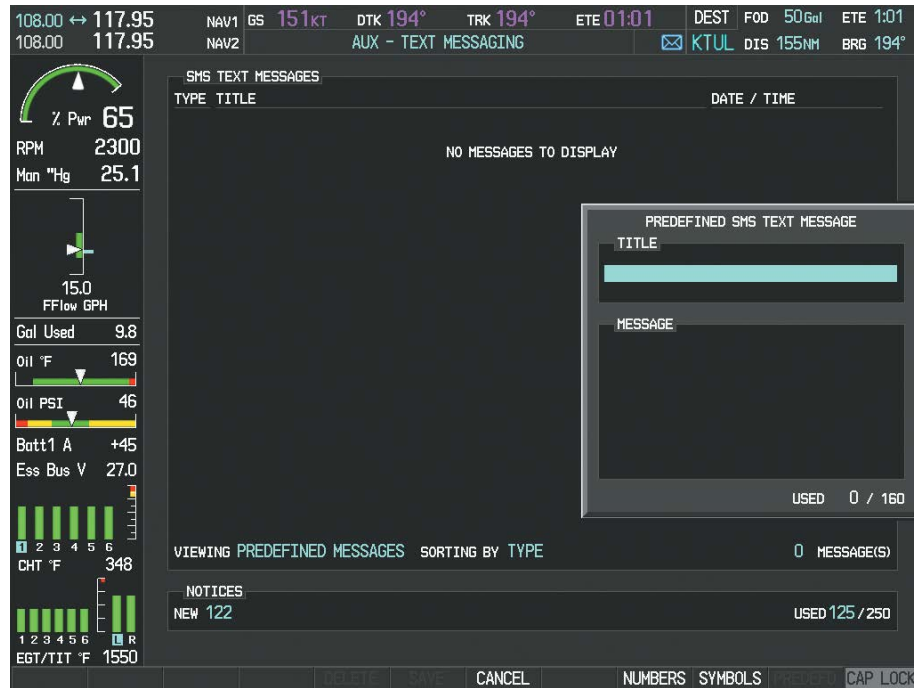

Figure 8-99 Composing a Predefined Message

- 5) The cursor is displayed in the 'TITLE' field. Enter the desired message title. Entry can be accomplished through the alphanumeric keys on the MFD Controller, or combination of the **FMS** Knob on the controller and softkeys on the MFD. The **FMS** Knob is used to enter letters and numbers, or numbers can be entered from the MFD by selecting the **NUMBERS** Softkey. Select the **CAP LOCK** Softkey to create upper and lower case alpha characters. Special characters can be accessed by selecting the **SYMBOLS** Softkey.
- 6) Press the **ENT** Key. The cursor is now displayed in the 'MESSAGE' field.
- 7) Enter the desired message using any combination of entry methods as described in step 5.
- 8) Press the **ENT** Key.
- 9) Select the **SAVE** Softkey. The new predefined message is now shown in the displayed list. Selecting the **CANCEL** Softkey will delete the message without saving.
- 10) Press the **MENU** Key to display the Page Menu.
- 11) Turn either **FMS** Knob to place the cursor on 'Stop Editing Predefined Message'.
- 12) Press the **ENT** Key.

Sending a predefined text message:

- 1) While viewing the AUX-TEXT MESSAGING Page, select the **NEW** Softkey.
- 2) The TEXT MESSAGE DRAFT Window is now displayed with the cursor in the 'TO' field. Enter the desired telephone number or email address. Entry can be accomplished through the alphanumeric keys on the MFD Controller, or combination of the **FMS** Knob on the controller and softkeys on the MFD. The **FMS** Knob is used to enter letters and numbers, or numbers can be entered from the MFD by selecting the **NUMBERS** Softkey. Select the **CAP LOCK** Softkey to create upper and lower case alpha characters. Special characters can be accessed by selecting the **SYMBOLS** Softkey.
- 3) Press the **ENT** Key. The cursor is now displayed in the 'MESSAGE' field (Figure 8-100).

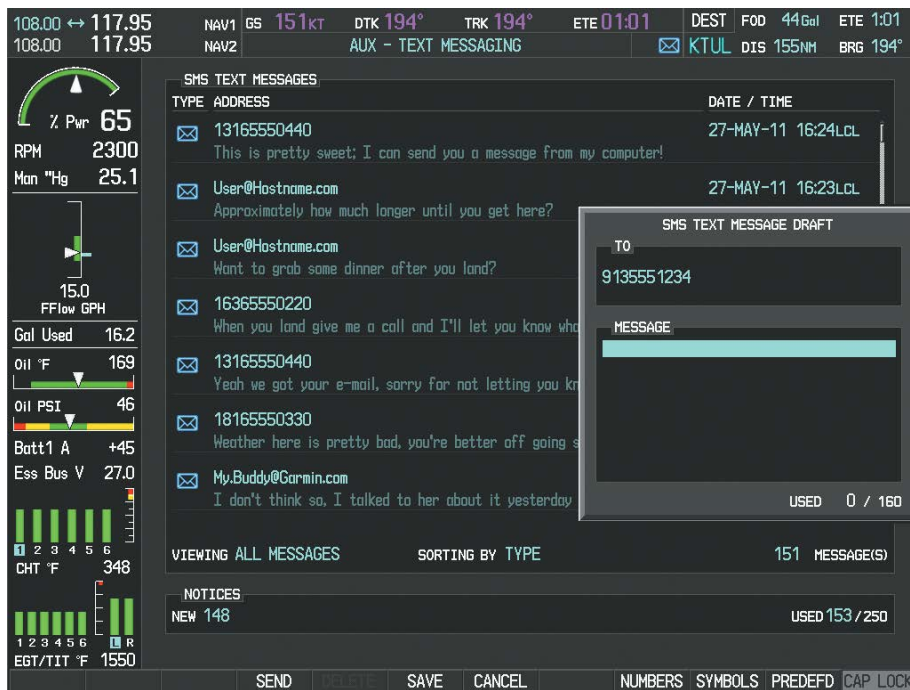

Figure 8-100 Sending a Predefined Text Message

- 4) Select the **PREDEFD** Softkey. The PREDEFINED MESSAGE MENU Window is displayed as seen in Figure 8-101.



Figure 8-101 Predefined Message List

- 5) Turn either **FMS** Knob to select the desired predefined message.
- 6) Press the **ENT** Key. The predefined message text is inserted into the message field. If desired, the message can be edited by using the FMS Knobs.
- 7) Press the **ENT** Key.
- 8) Select the **SEND** Softkey to transmit the message.

TEXT MESSAGE BOXES

Received text messages reside in the Inbox as ‘Read’ or ‘Unread’ messages. The Outbox contains ‘Sent’ and ‘Unsent’ text messages. Saved messages that are meant to be sent later are stored as Drafts. Each text message box may be viewed separately, or together in any combination.

Show Inbox messages:

While viewing the AUX-TEXT MESSAGING Page, select the **ARRANGE** Softkey, then select the **INBOX** Softkey (Figure 8-102).

Or:

- 1) Press the **MENU** Key to display the Page Menu.
- 2) Turn either **FMS** Knob to place the cursor on ‘Show Inbox Messages’.
- 3) Press the **ENT** Key. The message box selected for viewing is indicated at the bottom left of the list window.

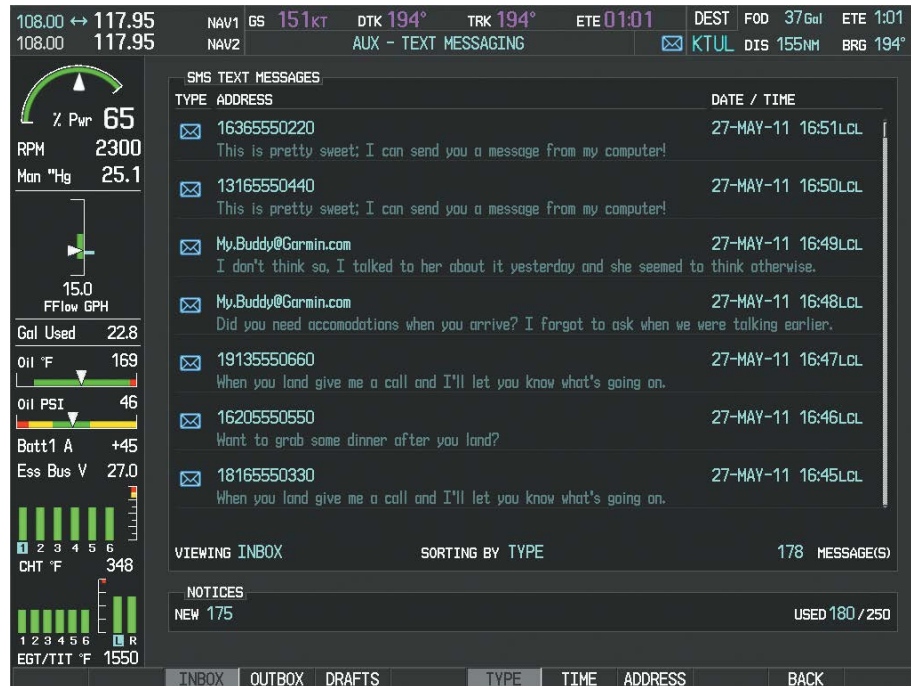

Figure 8-102 Text Message Inbox

Show Outbox messages:

While viewing the AUX-TEXT MESSAGING Page, select the **ARRANGE** Softkey, then select the **OUTBOX** Softkey.

Or:

- 1) Press the **MENU** Key to display the Page Menu.
- 2) Turn either **FMS** Knob to place the cursor on 'Show Outbox Messages'.
- 3) Press the **ENT** Key. The message box selected for viewing is indicated at the bottom left of the list window.

Show Draft messages:

While viewing the AUX-TEXT MESSAGING Page, select the **ARRANGE** Softkey, then select the **DRAFTS** Softkey.

Or:

- 1) Press the **MENU** Key to display the Page Menu.
- 2) Turn either **FMS** Knob to place the cursor on 'Show Draft Messages'.
- 3) Press the **ENT** Key. The message box selected for viewing is indicated at the bottom left of the list window.

MANAGING TEXT MESSAGES

The viewed messages may be listed according to the date/time the message was sent or received, the type of message (read, unread, sent, unsent, etc.), or by message address.

Viewing messages sorted by message date/time:

While viewing the AUX-TEXT MESSAGING Page, select the **ARRANGE** Softkey, then select the **TIME** Softkey (Figure 8-102).

Or:

- 1) Press the **MENU** Key to display the Page Menu.
- 2) Turn either **FMS** Knob to place the cursor on 'Sort By Date/Time'.
- 3) Press the **ENT** Key. The sorting selection is indicated at the bottom center of the list window.

Viewing messages sorted by message type:

While viewing the AUX-TEXT MESSAGING Page, select the **ARRANGE** Softkey, then select the **TYPE** Softkey.

Or:

- 1) Press the **MENU** Key to display the Page Menu.
- 2) Turn either **FMS** Knob to place the cursor on 'Sort By Type'.
- 3) Press the **ENT** Key. The sorting selection is indicated at the bottom center of the list window.

- SYSTEM OVERVIEW
- FLIGHT INSTRUMENTS
- EIS
- AUDIO PANEL & CNS
- FLIGHT MANAGEMENT
- HAZARD AVOIDANCE
- AFCS
- ADDITIONAL FEATURES
- APPENDICES
- INDEX

Viewing messages sorted by address:

While viewing the AUX-TEXT MESSAGING Page, select the **ARRANGE** Softkey, then select the **ADDRESS** Softkey.

Or:

- 1) Press the **MENU** Key to display the Page Menu.
- 2) Turn either **FMS** Knob to place the cursor on 'Sort By Address'.
- 3) Press the **ENT** Key. The sorting selection is indicated at the bottom center of the list window.

Viewing the content of a text message:

- 1) While viewing the AUX-TEXT MESSAGING Page, select the desired message box.
- 2) Push the **FMS** Knob to activate the cursor.
- 3) Turn either **FMS** Knob to select the desired message.
- 4) Select the **VIEW** Softkey.

Or:

Press the **ENT** Key.

Or:

- a) Press the **MENU** Key to display the Page Menu.
- b) Turn either **FMS** Knob to place the cursor on 'View Selected Message'.
- c) Press the **ENT** Key.

Message content is displayed as shown in Figure 8-103.

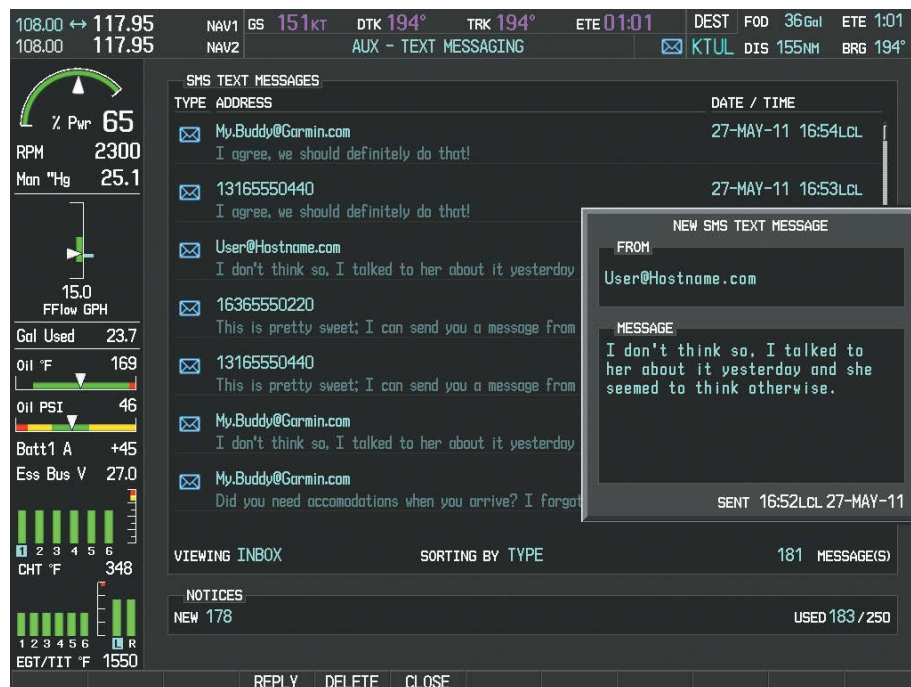

Figure 8-103 Viewing Message Content

- 5) To close the text message, select the **CLOSE** Softkey.
 - Or:**
 - a) Press the **MENU** Key to display the Page Menu.
 - b) Turn either **FMS** Knob to place the cursor on 'Close Message'.
 - c) Press the **ENT** Key.

Marking selected message as read:

- 1) While viewing the Inbox on the AUX-TEXT MESSAGING Page, push the **FMS** Knob to activate the cursor.
- 2) Turn either **FMS** Knob to select the desired message.
- 3) Select the **MRK READ** Softkey.
 - Or:**
 - a) Press the **MENU** Key to display the Page Menu.
 - b) Turn either **FMS** Knob to place the cursor on 'Mark Selected Message As Read'.
 - c) Press the **ENT** Key.

The message symbol now indicates the message has been opened.

Marking all messages as read:

- 1) While viewing the Inbox on the AUX-TEXT MESSAGING Page, press the **MENU** Key to display the Page Menu.
- 2) Turn either **FMS** Knob to place the cursor on 'Mark All New Messages As Read'.
- 3) Press the **ENT** Key. A confirmation window is displayed.
- 4) With cursor highlighting 'YES', press the **ENT** Key. The message symbols now indicate all the message have been opened.

Delete a message:

- 1) While viewing the Inbox on the AUX-TEXT MESSAGING Page, push the **FMS** Knob to activate the cursor.
- 2) Turn either **FMS** Knob to select the desired message.
- 3) Select the **DELETE** Softkey.
 - Or:**
 - a) Press the **MENU** Key to display the Page Menu.
 - b) Turn either **FMS** Knob to place the cursor on 'Delete Selected Message'.
 - c) Press the **ENT** Key.

- SYSTEM OVERVIEW
- FLIGHT INSTRUMENTS
- EIS
- AUDIO PANEL & CNS
- FLIGHT MANAGEMENT
- HAZARD AVOIDANCE
- AFCS
- ADDITIONAL FEATURES
- APPENDICES
- INDEX

8.10 WI-FI CONNECTIONS

The optional GDL 59 Data Link provides a Wi-Fi data link between the aircraft and a ground computer network.

Wi-Fi connections are used for transferring maintenance log data to the aircraft manufacturer. The system can connect to a IEEE 802.11g compatible network provided the aircraft is on the ground and located within range of a network. The system is capable of WEP64, WEP128, WPA-PSK, and WPA2-PSK encryption formats. WPA-Enterprise and WPA2-Enterprise are not supported. Connections that require web proxies, captive portals, or other elements that require user credentials, including a username and password or a redemption or access code; or require action such as accepting a user agreement, are not supported.

Control and monitoring of Wi-Fi functions are accomplished through the AUX-WI-FI SETUP Page.

Viewing the Wi-Fi Setup Page:

- 1) Turn the large **FMS** Knob on the MFD to select the AUX page group.
- 2) Turn the small **FMS** Knob to select DATA LINK. The AUX-WI-FI SETUP Page is displayed as shown in Figure 8-104.

Setting up a new Wi-Fi connection:

- 1) Select the **AVAIL** Softkey on the MFD. A list of available networks will be displayed in the AVAILABLE NETWORKS window as shown in Figure 8-104. Signal strength is shown for each network, as well as security methods and whether the network has been saved in the system's memory.



Figure 8-104 Available Wi-Fi Networks

- 2) If necessary, select the **RESCAN** Softkey to have the system scan again for available networks.
 - Or:
 - a) Press the **MENU** Key to display the Page Menu.
 - b) Turn either **FMS** Knob to place the cursor on 'Rescan Available Networks'.
 - c) Press the **ENT** Key.
- 3) Push the **FMS** Knob to place the cursor in the list of networks.
- 4) Turn either **FMS** Knob to select the desired network. See Figure 8-105.

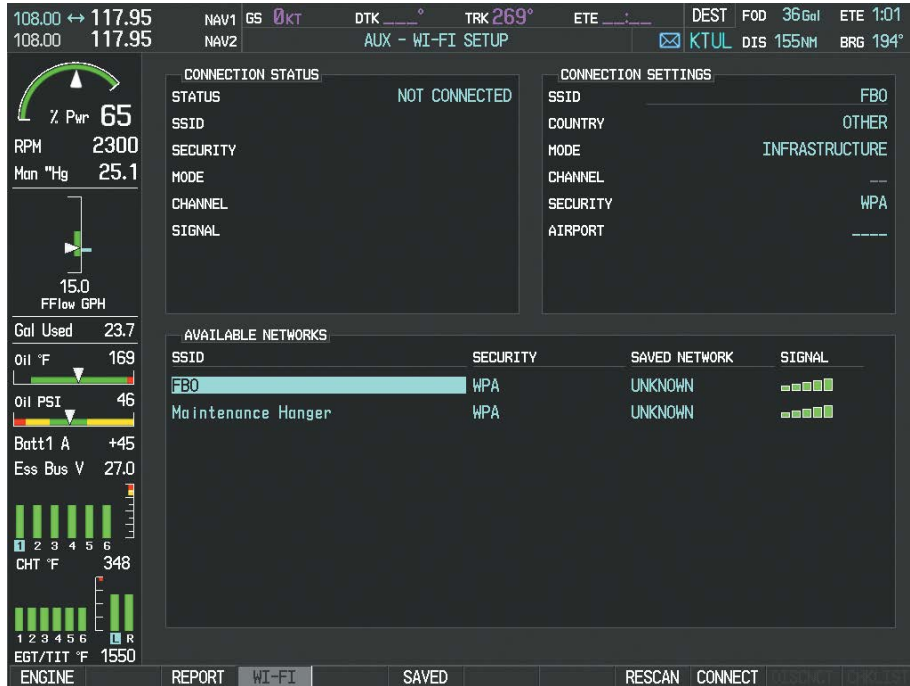

Figure 8-105 Desired Network Selected

- 5) Select the **CONNECT** Softkey.
 - Or:
 - a) Press the **MENU** Key to display the Page Menu.
 - b) Turn either **FMS** Knob to place the cursor on 'Connect To Selected Network'.
 - c) Press the **ENT** Key.
- 6) If the network is secured, a window similar to Figure 8-106 will be displayed in order to enter the necessary passcode. Use the **FMS** Knobs to enter the desired alpha numeric characters. Select the **CAP LOCK** Softkey to enter upper case letters. If there is no security associated with the network, proceed to step 9.



Figure 8-106 Enter Security Code

- 7) Press the **ENT** Key. 'OK' will be highlighted.
- 8) Press the **ENT** Key again.
- 9) The SAVE SETTINGS window is now displayed with the cursor highlighting 'SAVE CONNECTION'.

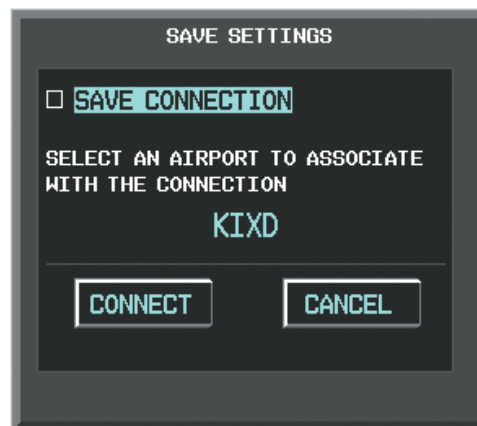

Figure 8-107 Save Option

- 10) The selected network can be saved to system memory to make re-connection easier at a later time.

Connecting the selected network without saving:

- a) Turn the large FMS Knob to move the cursor to highlight 'CONNECT'.
- b) Press the **ENT** Key.

Saving and connecting the selected network:

- a) Press the **ENT** Key. A checkmark is placed in the checkbox and the cursor moves to the airport field as shown in Figure 8-108.
- b) Using the **FMS** Knobs, enter an airport identifier to be associated with the saved network. This aids in identifying the network later in the event of duplicate network names.
- c) Press the **ENT** Key. The cursor moves to 'CONNECT'.
- d) Press the **ENT** Key again to connect to the selected network.

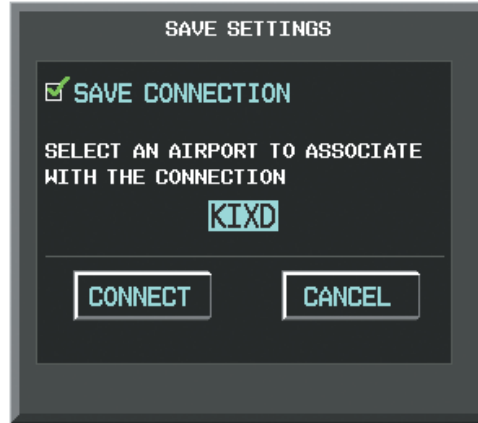

Figure 8-108 Save Connection

Editing a saved network:

- 1) While viewing list of saved networks, push the **FMS** Knob to activate the cursor as seen in Figure 8-109.
- 2) Turn either **FMS** Knob to highlight the network to be edited.
- 3) Pressing the **ENT** Key at this point will check or uncheck the AUTO CONNECT checkbox. When a checkmark is present, the system will automatically connect to the network when within range.



Figure 8-109 Select Network to be Edited

- 4) Select the **EDIT** Softkey. The cursor now appears in the CONNECTION SETTINGS window as shown in Figure 8-110.



Figure 8-110 Select Attributes to Edit

- 5) Turn the large **FMS** Knob to select the network attribute to be edited.
- 6) Turn the small **FMS** Knob to begin editing the field.
- 7) When the entry is complete, press the **ENT** Key.
- 8) Turn the large **FMS** Knob or press the **ENT** Key until 'SAVE' is highlighted.
- 9) Press the **ENT** Key.

Disconnecting a Wi-Fi network:

Select the **DISCNCT** Softkey.

Or:

- 1) Press the **MENU** Key to display the Page Menu.
- 2) Turn either **FMS** Knob to place the cursor on 'Disconnect From Network'.
- 3) Press the **ENT** Key.

Deleting a saved Wi-Fi network:

- 1) While viewing the list of saved networks, push the **FMS** Knob to activate the cursor.
- 2) Turn either **FMS** Knob to highlight the network to be deleted.
- 3) Select the **DELETE** Softkey. The selected network is removed from the list.

8.11 SCHEDULER

The Scheduler feature can be used to enter and display reminder messages (e.g., Change oil, Switch fuel tanks, or Altimeter-Transponder Check) in the Messages Window on the PFD. Messages can be set to display based on a specific date and time (event), once the message timer reaches zero (one-time; default setting), or recurrently whenever the message timer reaches zero (periodic). Message timers set to periodic alerting automatically reset to the original timer value once the message is displayed. When power is cycled, all messages are retained until deleted, and message timer countdown is resumed.

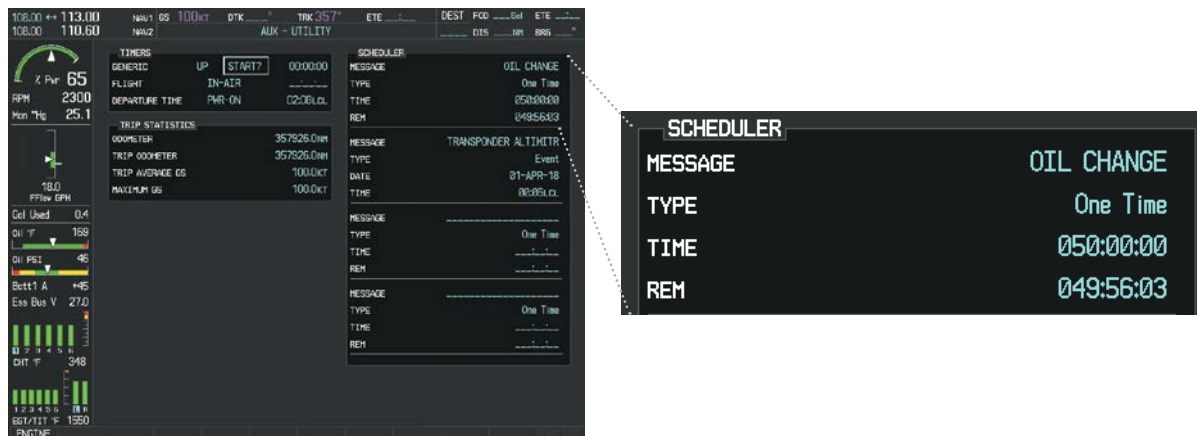

Figure 8-111 Scheduler (Utility Page)

Entering a scheduler message:

- 1) Select the AUX - Utility Page.
- 2) Push the **FMS** Knob momentarily to activate the flashing cursor.
- 3) Turn the large **FMS** Knob to highlight the first empty scheduler message naming field.
- 4) Use the **FMS** Knob to enter the message text to be displayed in the Messages Window and press the **ENT** Key.
- 5) Press the **ENT** Key again or use the large **FMS** Knob to move the cursor to the field next to Type.
- 6) Turn the small **FMS** Knob to select the message alert type:
 - Event—Message issued at the specified date/time
 - One-time—Message issued when the message timer reaches zero (default setting)
 - Periodic—Message issued each time the message timer reaches zero
- 7) Press the **ENT** Key again or use the large **FMS** Knob to move the cursor to the next field.
- 8) For periodic and one-time message, use the **FMS** Knob to enter the timer value (HH:MM:SS) from which to countdown and press the **ENT** Key.
- 9) For event-based messages:
 - a) Use the **FMS** Knob to enter the desired date (DD-MM-YY) and press the **ENT** Key.
 - b) Press the **ENT** Key again or use the large **FMS** Knob to move the cursor to the next field.
 - c) Use the **FMS** Knob to enter the desired time (HH:MM) and press the **ENT** Key.
- 10) Press the **ENT** Key again or use the large **FMS** Knob to move the cursor to enter the next message.

Deleting a scheduler message:

- 1) Select the AUX - Utility Page.
- 2) Push the **FMS** Knob momentarily to activate the flashing cursor.
- 3) Turn the large **FMS** Knob to highlight the name field of the scheduler message to be deleted.
- 4) Press the **CLR** Key to clear the message text. If the **CLR** Key is pressed again, the message is restored.
- 5) Press the **ENT** Key while the message line is cleared to clear the message time.

Scheduler messages appear in the Messages Window on the PFD. When a scheduler message is waiting, the **ALERTS** Softkey label changes to **ADVISORY**. Pressing the **ADVISORY** Softkey opens the Messages Window and acknowledges the scheduler message. The softkey label reverts to **ALERTS** when pressed. Pressing the **ALERTS** Softkey again removes the Messages Window from the display, and the scheduler message is deleted from the message queue.



Figure 8-112 PFD Messages Window

8.12 ELECTRONIC CHECKLISTS

NOTE: The optional checklists presented here are for example only and may differ from checklists available for the SR20/SR22. The information described in this section is not intended to replace the checklist information described in the pertinent flight manual or the Pilot Safety and Warning Supplements document.

NOTE: Garmin is not responsible for the content of checklists. Checklists are created by the aircraft manufacturer. Modifications or updates to the checklists are coordinated through the aircraft manufacturer. The user cannot edit these checklists.

The optional checklist functions are displayed on two levels of softkeys that are available on any MFD page.

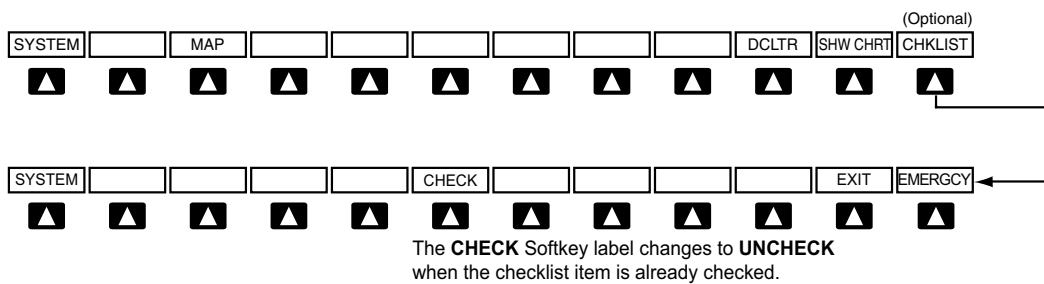

Figure 8-124 Checklist Softkeys

The MFD is able to display optional electronic checklists which allow a pilot to quickly find the proper procedure on the ground and during each phase of flight. The system accesses the checklists from an SD card inserted into the bezel slot. If the SD card contains an invalid checklist file or no checklist, the Power-up Page messages display ‘Checklist File: Invalid’ or ‘Checklist File: N/A’ (not available) and the **CHKLIST** Softkey is not available.

Accessing and navigating checklists:

- 1) From any page on the MFD (except the EIS Pages), press the **CHKLIST** Softkey or turn the large **FMS** Knob to select the Checklist Page.
- 2) Turn the large **FMS** Knob to select the ‘GROUP’ field.
- 3) Turn the small **FMS** Knob to select the desired procedure and press the **ENT** Key.
- 4) Turn the large **FMS** Knob to select the ‘CHECKLIST’ field.
- 5) Turn the **FMS** Knob to select the desired checklist and press the **ENT** Key. The selected checklist item is indicated with white text surrounded by a white box.
- 6) Press the **ENT** Key or **CHECK** Softkey to check the selected checklist item. The line item turns green and a checkmark is placed in the associated box. The next line item is automatically selected for checking.

Either **FMS** Knob can be used to scroll through the checklist and select the desired checklist item.

Press the **CLR** Key or **UNCHECK** Softkey to remove a check mark from an item.

- 7) When all checklist items have been checked, '*Checklist Finished*' is displayed in green text at the bottom left of the checklist window. If all items in the checklist have not be checked, '*CHECKLIST NOT FINISHED*' will be displayed in yellow text.
- 8) Press the **ENT** Key. 'GO TO NEXT CHECKLIST?' will be highlighted by the cursor.
- 9) Press the **ENT** Key to advance to the next checklist.
- 10) Press the **EXIT** Softkey to exit the Checklist Page and return to the page last viewed.

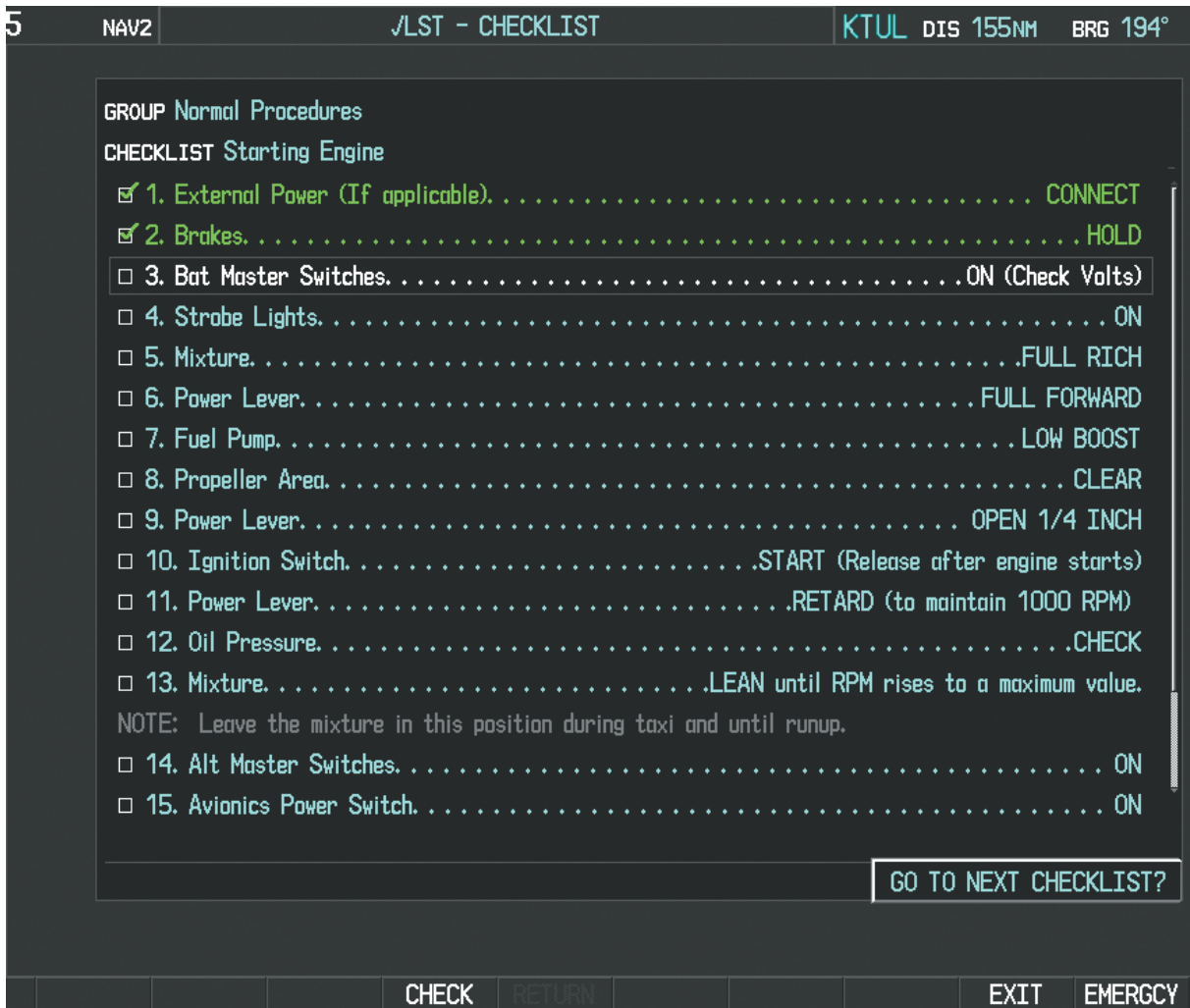

Figure 8-113 Sample Checklist

Accessing emergency procedures:

- 1) From any page on the MFD (except the EIS Pages), press the **CHKLIST** Softkey or turn the large **FMS** Knob to select the Checklist Page.
- 2) Press the **EMERGENCY** Softkey.
- 3) Turn the **FMS** Knob to select the desired emergency checklist and press the **ENT** Key.

- 4) Press the **ENT** Key or **CHECK** Softkey to check the selected emergency checklist item. The line item turns green and a checkmark is placed in the box next to it. The next line item is automatically highlighted for checking. Either **FMS** Knob can be used to scroll through the checklist and select the desired checklist item. Press the **CLR** Key or **UNCHECK** Softkey to remove a check mark from an item.
- 5) When all checklist items have been checked, '*Checklist Finished*' is displayed in green text at the bottom left of the checklist window. If all items in the checklist have not be checked, '*CHECKLIST NOT FINISHED*' will be displayed in yellow text.
- 6) Press the **ENT** Key. 'GO TO NEXT CHECKLIST?' will be highlighted by the cursor.
- 7) Press the **ENT** Key to advance to the next checklist.
- 8) Press the **RETURN** Softkey to return to the previous checklist.
- 9) Press the **EXIT** Softkey to exit the Checklist Page and return to the page last viewed.

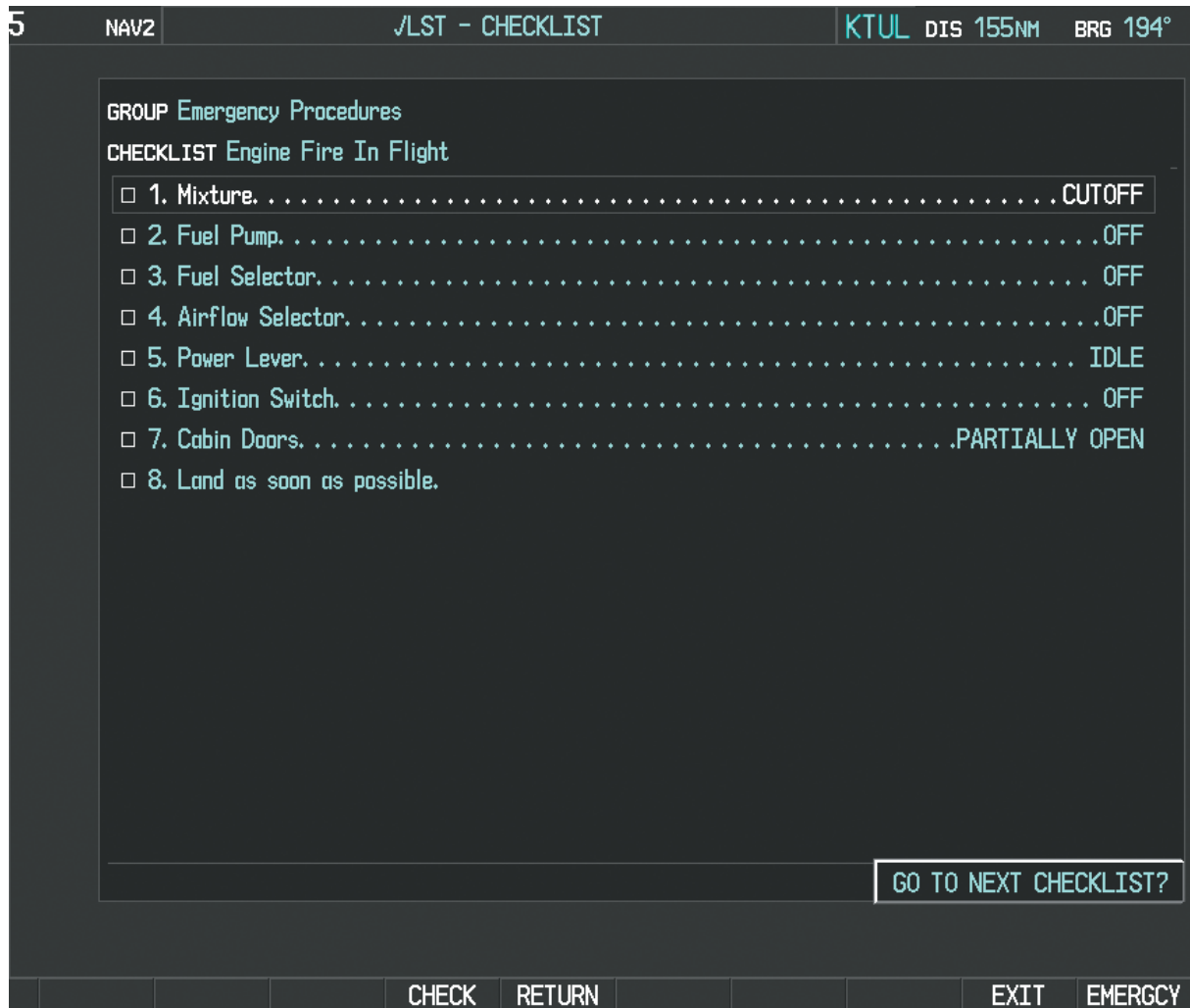

Figure 8-114 Emergency Checklist Page Example

8.13 FLIGHT DATA LOGGING



NOTE: *Some aircraft installations may not provide all aircraft/engine data capable of being logged by the system.*

The Flight Data Logging feature will automatically store critical flight and engine data on an SD data card (up to 16GB) inserted into the top card slot of the MFD. Approximately 1,000 flight hours can be recorded for each 1GB of available space on the card.

Data is written to the SD card once each second while the MFD is powered on. All flight data logged on a specific date is stored in a file named in a format which includes the date, time, and nearest airport identifier. The file is created automatically each time the system is powered on, provided an SD card has been inserted.

The status of the Flight Data Logging feature can be viewed on the AUX-UTILITY Page. If no SD card has been inserted, “NO CARD” is displayed. When data is being written to the SD card, “LOGGING DATA” is displayed.

The .csv file may be viewed with Microsoft Excel® or other spreadsheet applications.

The following is a list of data parameters the Perspective® system is capable of logging for the SR20 and SR22.

- Date
- Time
- GPS altitude (MSL)
- GPS altitude (WGS84 datum)
- Baro-Corrected altitude (feet)
- Baro Correction (in/Hg)
- Indicated airspeed (kts)
- Vertical speed (fpm)
- GPS vertical speed (fpm)
- OAT (degrees C)
- True airspeed (knots)
- Pitch Attitude Angle (degrees)
- Roll Attitude Angle (degrees)
- Lateral and Vertical G Force (g)
- Ground Speed (kts)
- Ground Track (degrees magnetic)
- Latitude (degrees; geodetic; +North)
- Longitude (degrees; geodetic; +East)
- Magnetic Heading (degrees)
- HSI source
- Selected course
- Com1/Com2 frequency
- Nav1/Nav2 frequency
- CDI deflection
- VDI/GP/GS deflection
- Wind Direction (degrees)
- Wind Speed (knots)
- Active Waypoint Identifier
- Distance to next waypoint (nm)
- Bearing to next waypoint (degrees)
- Magnetic variation (degrees)
- Autopilot On/Off
- AFCS roll/pitch modes
- AFCS roll/pitch commands
- GPS fix
- GPS horizontal alert limit
- GPS vertical alert limit
- SBAS GPS horizontal protection level
- SBAS GPS vertical protection level
- Fuel Qty (right & left)(gals)
- Fuel Flow (gph)
- Fuel Pressure (psi)
- Voltage 1 and/or 2
- Amps 1 and/or 2
- Engine RPM
- Oil Pressure (psi)
- Oil Temperature (deg. F)
- TIT (deg. F)
- Manifold Pressure (in. Hg)
- CHT
- EGT

The file containing the recorded data will appear in the format shown in Figure 8-115. This file can be imported into most computer spreadsheet applications.

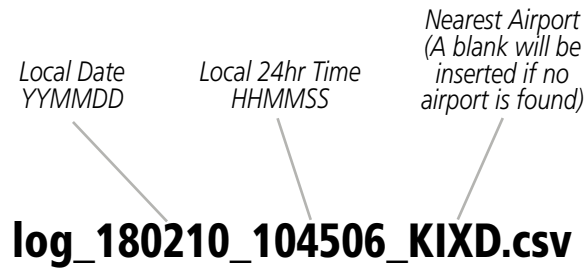

Figure 8-115 Log File Format

Data logging status can be monitored on the AUX-UTILITY Page.

- SYSTEM OVERVIEW
- FLIGHT INSTRUMENTS
- EIS
- AUDIO PANEL & CNS
- FLIGHT MANAGEMENT
- HAZARD AVOIDANCE
- AFCS
- ADDITIONAL FEATURES**
- APPENDICES
- INDEX

8.14 HYPOXIA RECOGNITION WITH AUTOMATIC DESCENT MODE

Hypoxia Recognition detects pilot incapacitation due to the affects of hypoxia or other physical conditions. This is accomplished by monitoring pilot interaction with the Perspective® system. If the system determines the pilot is not responding, Automatic Descent Mode is activated placing the aircraft in a descent to a lower altitude to provide the pilot and passengers an opportunity to recover from the effects of hypoxia.

The system is operative when the aircraft altitude is above 14,900 feet (pressure altitude) and the Garmin AFCS autopilot is engaged. Pilot interaction with the Perspective® system is monitored by detecting key presses and turns of the knobs (Audio Panel and push-to-talk switch excluded). If a period of inactivity (time dependent on altitude, see Figure 8-116) is detected, Hypoxia Recognition initiates an automatic descent.

Upon activation, there are three sequential phases employed by the system; determining pilot alertness, descent to 14,000 feet MSL, and descent to 12,500 feet MSL.

DETERMINING PILOT ALERTNESS

When the system detects a sufficient period of inactivity (Figure 8-116) the Advisory Annunciation 'ARE YOU ALERT?' is displayed. Selecting the **ALERT** Softkey will acknowledge the message and reset the system. Pressing any other softkey, or turning a knob will also reset the system.

When no pilot interaction is detected for an additional 60 seconds, the Caution Annunciation 'HYPOXIA ALERT' is displayed. Again, selecting the **ALERT** Softkey will acknowledge the message and reset the system. Pressing any other softkey, or turning a knob will also reset the system.

When no pilot interaction is detected for an additional 60 seconds, the Warning Annunciation 'AUTO DESCENT' is displayed in the Annunciation Window and 'Automatic descent to 14,000FT in 60 seconds' is displayed in the Alerts Window. Once again, selecting the **ALERT** Softkey will acknowledge the message and reset the system. Pressing any other softkey, or turning a knob will also reset the system.

When no interaction is detected for another 60 seconds, the system will automatically proceed with the descent.

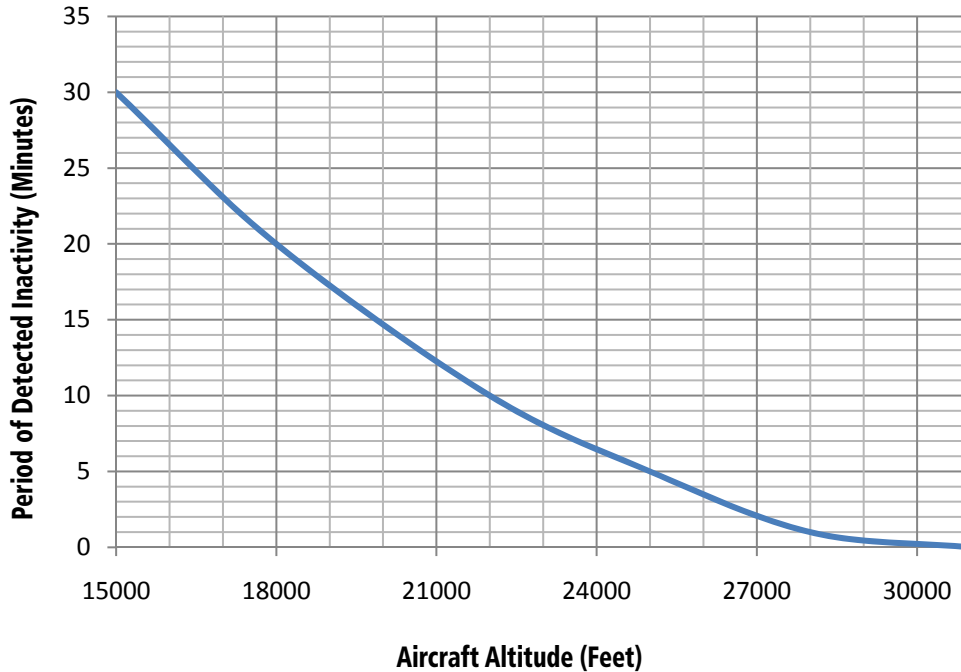

Figure 8-116 Hypoxia Recognition Activation Times

AUTOMATIC DESCENT MODE



NOTE: Automatic Descent Mode does not account for terrain elevation.

As the system prepares for descent, the Selected Altitude is set to 14,000 and the AFCS enters Indicated Airspeed (IAS) mode with the airspeed reference set to the maximum allowable airspeed setting for the specific aircraft model. Refer to the Flight Director Vertical Modes in the AFCS section. AFCS lateral mode settings are not affected.

As the descent begins, an ‘AUTO DESCENT’ warning is displayed in the Annunciation Window. ‘AUTO DESCENT - Aircraft Descending to 14,000FT’ is displayed in the Alerts Window. ‘EDM’ is shown as an AFCS Status Annunciation indicating the system has entered Automatic Descent Mode. ‘EDM’ (Emergency Descent Mode) is the AFCS mode that is activated when Hypoxia Recognition initiates an automatic descent. A continuous repeating chime will be heard as long as Automatic Descent Mode is active. After the descent begins, Automatic Descent Mode can only be canceled by disconnecting the autopilot.

As the aircraft reaches 14,000 feet the system sets the AFCS to Altitude Hold mode. The AFCS will also remain in Automatic Descent Mode as indicated by ‘EDM’ continuing to be displayed as an AFCS Status Annunciation. The system again begins monitoring for pilot interaction.

If no pilot interaction is detected for four minutes, the system initiates the second descent. As the system prepares for this descent, the Selected Altitude is set to 12,500 and the AFCS again enters IAS mode with the airspeed reference set to the maximum allowable airspeed for the specific aircraft model.

- SYSTEM OVERVIEW
- FLIGHT INSTRUMENTS
- EIS
- AUDIO PANEL & CNS
- FLIGHT MANAGEMENT
- HAZARD AVOIDANCE
- AFCS
- ADDITIONAL FEATURES
- APPENDICES
- INDEX

As the descent begins, an 'AUTO DESCENT' warning is displayed in the Annunciation Window. 'AUTO DESCENT - Aircraft Descending to 12,500FT' is displayed in the Alerts Window. 'EDM' is shown as an AFCS Status Annunciation. Also, the continuous repeating chime is heard.

As the aircraft reaches 12,500 feet the system sets the AFCS to Altitude Hold mode. The AFCS will also remain in Automatic Descent Mode as indicated by 'EDM' continuing to be displayed as an AFCS Status Annunciation as well as the continuing presence of the repeating chime. At this point, the AFCS must be disconnected to cancel Automatic Descent Mode.

8.15 ELECTRONIC STABILITY AND PROTECTION (ESP™)

The optional Garmin Electronic Stability and Protection (ESP™) system is available only when the Garmin AFCS is installed. This system is designed to provide automatic control inputs to discourage aircraft operation outside the normal flight envelope. Garmin ESP™ works to maintain the desired pitch, roll, and airspeed operating envelope by automatically engaging one or more servos when the aircraft is near a defined pitch, roll, and/or airspeed operating limit. While ESP™ utilizes the same sensors, processors, and actuators as the Garmin AFCS autopilot, it is a separate function. When the Garmin AFCS autopilot is engaged and/or the aircraft is at or below 200 feet AGL, the ESP™ system will not operate.

ESP™ engages when the aircraft exceeds one or more conditions (pitch, roll, and airspeed) beyond the normal flight parameters. Enhanced stability for each condition is provided by applying a force to the appropriate control surface to return the aircraft to the normal flight envelope. This is perceived by the pilot as resistance to control movement in the undesired direction when the aircraft approaches a steep attitude or high airspeed.

As the aircraft deviates further from the normal attitude and/or airspeed range, the force increases (up to an established maximum) to encourage control movement in the direction necessary to return to the normal attitude and/or airspeed range. Except in the case of high airspeed, when maximum force is reached, force remains constant up to the maximum engagement limit. Above the maximum engagement limit, forces are no longer applied. There is no maximum engagement related to a high airspeed condition.

The pilot can interrupt ESP™ by pressing and holding the Autopilot Disconnect (**AP DISC**) switch. Upon releasing the **AP DISC** switch, ESP™ force will again be applied, provided aircraft roll attitude is within engagement limits. ESP™ can also be overridden by overpowering the servo's mechanical torque limit.

ESP™ can be enabled or disabled on the AUX-SYSTEM SETUP 2 Page on the MFD.

To enable or disable ESP™:

- 1) Turn the large **FMS** Knob to select the AUX Page Group.
- 2) Turn the small **FMS** Knob to select the System Setup Page.
- 3) If necessary, select the **SETUP 2** Softkey to display the AUX-SYSTEM SETUP 2 Page. If the AUX-SYSTEM SETUP 2 is already displayed, proceed to step 4.
- 4) Push the **FMS** Knob to activate the cursor.
- 5) Turn the large **FMS** Knob to place the cursor in the STABILITY & PROTECTION field.
- 6) Turn the small **FMS** Knob to select 'ENABLE' or 'DISABLE'.
- 7) Push the **FMS** Knob to remove the cursor.

ESP™ is automatically enabled on system power up.

ROLL ENGAGEMENT

Roll Limit Indicators are displayed on the roll scale at 45° right and left, indicating where ESP™ will engage (see Figure 8-117). As roll attitude exceeds 45°, ESP™ will engage and the on-side Roll Limit Indicator will move to 30°, as shown in Figure 8-118. The Roll Limit Indicator is now showing where ESP™ will disengage as roll attitude decreases.

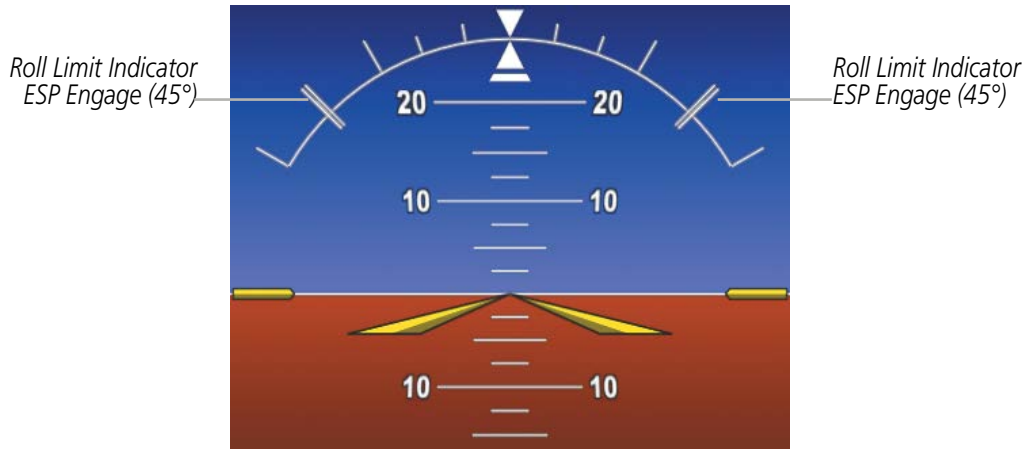

Figure 8-117 ESP Roll Engagement Indication (ESP NOT Engaged)

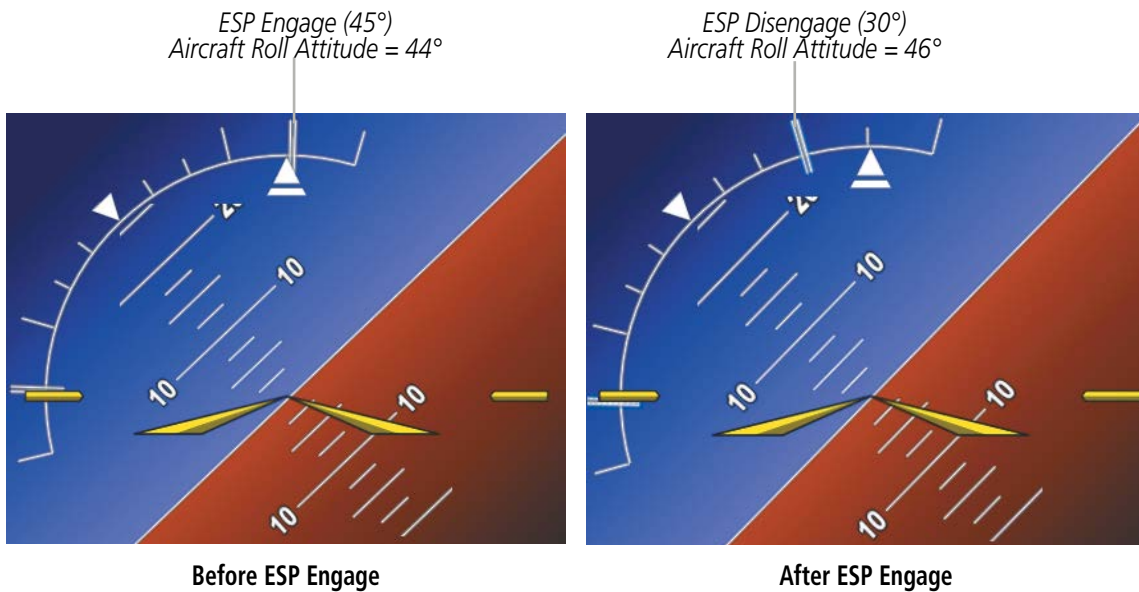

Figure 8-118 Roll Increasing to ESP Engagement

Once engaged, ESP™ force will be applied between 30° and 75°, as illustrated in Figure 8-119. The force increases as roll attitude increases and decreases as roll attitude decreases. The applied force is intended to

encourage pilot input that returns the airplane to a more normal roll attitude. As roll attitude decreases, ESP™ will disengage at 30°.

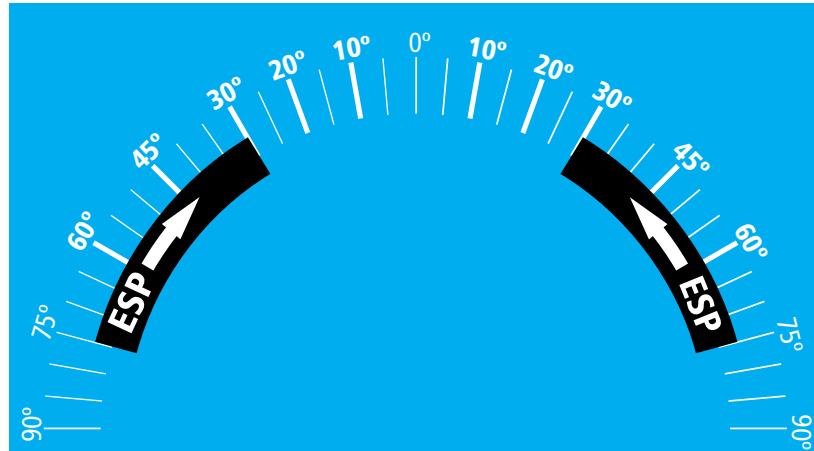

Figure 8-119 ESP Roll Operating Range When Engaged (Force Increases as Roll Increases & Decreases as Roll Decreases)

ESP™ is automatically disengaged if the aircraft reaches the autopilot roll engagement attitude limit of 75° (Figure 8-120).

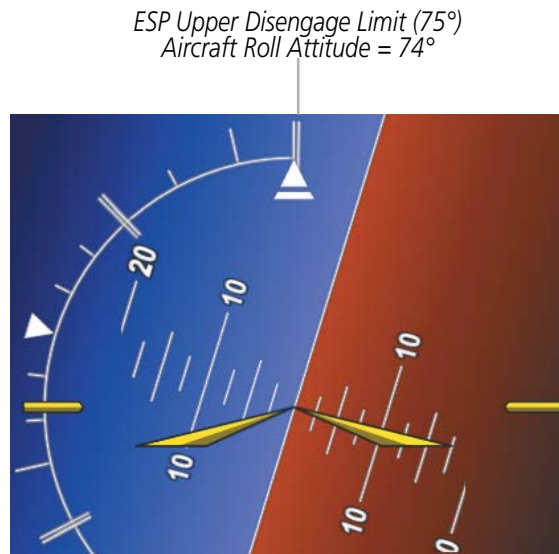

Figure 8-120 Roll Attitude Autopilot Engagement Limit (ESP Engaged)

PITCH ENGAGEMENT

ESP™ engages at 17.5° nose-up and 15.5° nose-down. Once ESP™ is engaged, it will apply opposing force between 17.5° and 50° nose-up and between 15.5° and 50° nose-down, as indicated in Figure 8-122. Maximum opposing force is applied between 22.5° and 50° nose-up and between 20.5° and 50° nose-down.

With ESP™ engaged, and the aircraft in a nose-up condition, opposing force steadily decreases from 17.5° nose-up to 12.5° nose-up as aircraft pitch moves toward zero degrees. ESP™ disengages at 12.5° nose-up. With

ESP™ engaged, and the aircraft in a nose-down condition, opposing force steadily decreases from 15.5° nose-down to 10.5° nose-down as aircraft pitch moves toward zero degrees. ESP™ disengages at 10.5° nose-down.

The opposing force increases or decreases depending on the pitch angle and the direction of pitch travel. This force is intended to encourage movement in the pitch axis in the direction of the normal pitch attitude range for the aircraft.

There are no indications marking the pitch ESP™ engage and disengage limits in these nose-up/nose-down conditions.

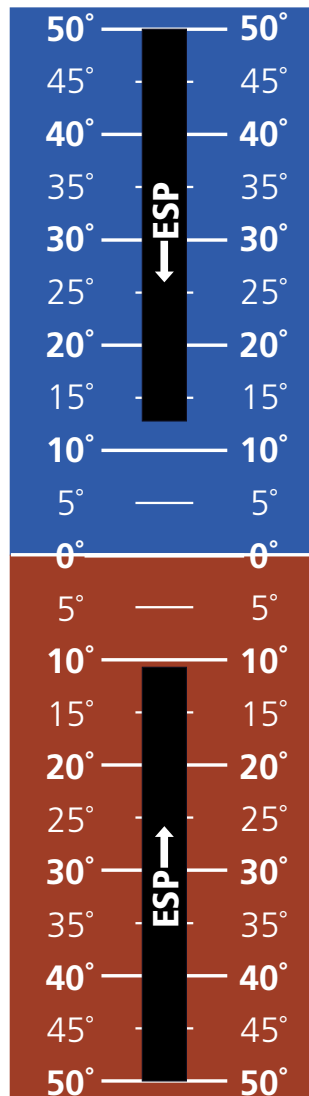

Figure 8-121 ESP Pitch Operating Range When Engaged
 (Force Increases as Pitch Increases & Decreases as Pitch Decreases)

LOW SPEED PROTECTION

Low speed protection is provided as part of the ESP feature. When the stall warning system determines a stall condition is imminent, ESP will engage, applying force in the direction necessary to lower the nose of the aircraft.

HIGH AIRSPEED PROTECTION

Exceeding V_{ne} will result in ESP™ applying force to raise the nose of the aircraft. When the high airspeed condition is remedied, ESP™ force is no longer applied.

8.16 POSITION REPORTING



NOTE: An account must be established with Garmin Connex[™] to make full use of the Position Reporting feature.

The Position Reporting feature allows the system to send position reporting information to a provider, such as FlightAware.com.

The position reports can be activated or deactivated by the pilot. While active, the position reports are transmitted over the Iridium Short Burst Datalink periodically at a pilot specified interval or by pressing the **SEND RPT** Softkey. The minimum automatic transmission period between reports is two minutes with more frequent transmissions possible via manually sending reports with the **SEND RPT** Softkey. During voice communications and data transfers the Iridium datalink is occupied and position reports will not be sent. During this period the reports will buffer and be sent as a package as soon as the link is available. The position reports are received by Garmin Connex and forwarded to select flight tracking provider(s).

To reduce excess usage, position reports are only transmitted while the aircraft is in the air.

The following are position reports contents:

- Tail Number
- Time
- Latitude/Longitude
- Ground Speed
- Ground Track
- Heading
- Barometric Altitude
- True Airspeed
- Outside Air Temperature
- Destination
- Estimated Time Enroute (ETE)
- Airborne Status

The Airborne Status field is the indication that the aircraft is on the ground or in the air at the time the position report was generated. The avionics generate a position report when the Airborne Status field changes state.

- Passenger Onboard

Passenger Onboard indicates passengers are on the aircraft at the time the position report was generated. A position report is generated when the Passenger Onboard field changes state.

Viewing the Connex Page:

- 1) Turn the large **FMS** Knob on the MFD to select the AUX page group.

- Turn the small **FMS** Knob to select AUX-CONNEXT Page as seen in Figure 8-122.



Figure 8-122 AUX-CONNEXT Page

Setting up Position Reporting:

- With the AUX-CONNEXT Page displayed, push the **FMS** Knob to display the cursor in the TRANSMISSION PERIOD field as in Figure 8-123.

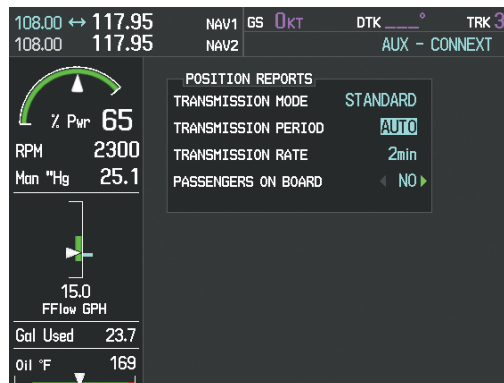

Figure 8-123 Set Transmission Period

- Turn the small **FMS** Knob to select 'AUTO' for automatic transmission of position reports or 'OFF' to disable transmission of position reports.
- Press the **ENT** Key. The selection is entered and the cursor is placed in the TRANSMISSION RATE field.
- Turn the small **FMS** Knob to highlight the first digit, as shown in Figure 8-125.

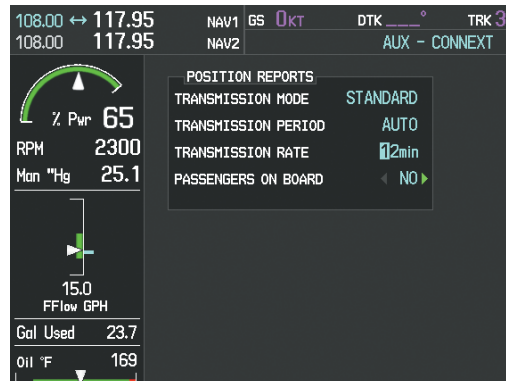

Figure 8-124 Set Transmission Rate

- 5) Again, turn the small **FMS** Knob to enter the desired number.
- 6) Turn the large **FMS** Knob to highlight the second digit.
- 7) Turn the small **FMS** Knob to enter the desired number.
- 8) Press the **ENT** Key. The selection is entered and the cursor is placed in the PASSENGERS ON BOARD field.
- 9) Turn the small **FMS** Knob left or right to select 'YES' or 'NO', as shown in Figure 8-126.

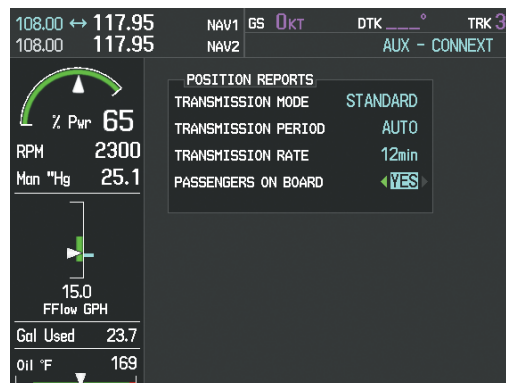

Figure 8-125 Set Transmission Rate

- 10) Push the **FMS** Knob to remove the cursor.

To send a position report manually:

- 1) Turn the large **FMS** Knob on the MFD to select the AUX page group.
- 2) Turn the small **FMS** Knob to select AUX-CONNEXT Page.
- 3) If necessary, set the TRANSMISSION PERIOD to 'AUTO'.
- 4) Press the **SEND RPT** Softkey, as seen in Figure 8-123.

8.17 BLUETOOTH® MANAGEMENT

The Bluetooth Management Page allows for setting up the installed optional Flight Stream device for a Bluetooth connection between the Perspective® system and a mobile device running Garmin Pilot™, or other compatible application. When connected, GPS and AHRS data is shared with the mobile device. Also, flight plans can be transferred from the mobile device to the Perspective® system. See the Flight Planning discussion in the Flight Management section of this manual and the Garmin Pilot User Guide for more details regarding flight plans.

The mobile device must be ‘paired’ with the Perspective® system in order to use the various functions. Pairing is accomplished by first placing the Perspective® system in pairing mode by displaying the Bluetooth Management Page as shown in Figure 8-127. Note the ‘PAIRING MODE’ field shows ‘ENABLED’. The system is ‘discoverable’ whenever this page is displayed. The pairing operation is completed from the mobile device and Garmin Pilot, or other application. See the device Bluetooth pairing instructions and the connection instructions in the application.

The following functions are also available on this page display:

- Changing the Bluetooth name
- Enabling and disabling import of flight plans from a mobile device
- Enabling and disabling automatic reconnection to individual paired devices
- Removal of specific paired devices



Figure 8-126 Bluetooth Management Page

Viewing the Bluetooth Management Page:

- 1) Turn the large **FMS** Knob on the MFD to select the AUX page group.
- 2) Turn the small **FMS** Knob to select the BLUETOOTH MANAGEMENT page.

Changing the Bluetooth name:

- 1) While viewing the Bluetooth Management Page, push the **FMS** Knob to activate the cursor.
- 2) Turn the large **FMS** Knob to place the cursor in the 'BLUETOOTH NAME' field.
- 3) Enter the desired name by using the large **FMS** Knob to select the character field, and the small **FMS** Knob select the desired alphanumeric character for that field.
- 4) Press the **ENT** Key. The cursor is removed and the new name is displayed.

Enabling/Disabling Flight Plan importing from Garmin Pilot or other compatible application:

- 1) While viewing the Bluetooth Management Page, push the **FMS** Knob to activate the cursor.
- 2) Turn the large **FMS** Knob to place the cursor in the 'FLIGHT PLAN IMPORT' field.
- 3) Turn the small **FMS** Knob to select 'ENABLED' or 'DISABLED'.
- 4) Push the **FMS** Knob to remove the cursor.

Enabling/Disabling automatic reconnection of a specific paired device:

- 1) While viewing the Bluetooth Management Page, push the **FMS** Knob to activate the cursor.
- 2) Turn the large **FMS** Knob to highlight the desired paired device.
- 3) Turn the small **FMS** Knob to select 'ENABLED' or 'DISABLED'. Selecting 'ENABLED' allows Perspective® to automatically connect to a previously-paired device when detected.
- 4) Push the **FMS** Knob to remove the cursor.

Removing a specific paired device from the list of paired devices:

- 1) While viewing the Bluetooth Management Page, push the **FMS** Knob to activate the cursor.
- 2) Turn the large **FMS** Knob to highlight the desired paired device.
- 3) Press the **REMOVE** Softkey. A confirmation screen is displayed as seen in Figure 8-127.

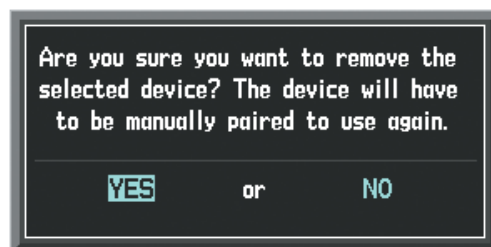

Figure 8-127 Device Removal Confirmation

- 4) If necessary, turn the large **FMS** Knob to select 'YES'.
- 5) Press the **ENT** Key to remove the device from the list of paired devices.

8.18 ABNORMAL OPERATION

SVT TROUBLESHOOTING

SVT is intended to be used with traditional attitude, heading, obstacle, terrain, and traffic inputs. SVT is disabled when valid attitude or heading data is not available for the display. In case of invalid SVT data, the PFD display reverts to the standard blue-over-brown attitude display.

SVT becomes disabled without the following data resources:

- Attitude data
- Heading data
- GPS position data
- 9 Arc-second Terrain data
- Obstacle data
- TAWS-B function is not available, in test mode, or failed
- The position of the aircraft exceeds the range of the terrain database.

REVERSIONARY MODE

SVT can be displayed on the Multifunction Display (MFD) in Reversionary Mode. If it is enabled when switching to Reversionary Mode, SVT will take up to 30 seconds to be displayed. The standard, non-SVT PFD display will be shown in the interim.



Figure 8-128 SVT Reversionary Mode

UNUSUAL ATTITUDES

Unusual attitudes are displayed with red chevrons overlaid on the display indicating the direction to fly to correct the unusual attitude condition. The display shows either a brown or blue colored bar at the top or bottom of the screen to represent earth or sky. This is intended to prevent losing sight of the horizon during extreme pitch attitudes.



Figure 8-129 Unusual Attitude Display

The blue colored bar is also displayed when terrain gradient is great enough to completely fill the display.



Figure 8-130 Blue Sky Bar with Full Display Terrain

GDL 69/69A DATA LINK RECEIVER TROUBLESHOOTING

Some quick troubleshooting steps listed below can be performed to find the possible cause of a failure.

- Ensure the owner/operator of the aircraft in which the Data Link Receiver is installed has subscribed to Sirius XM Radio Inc.
- Ensure the SiriusXM subscription has been activated
- Perform a quick check of the circuit breakers to ensure that power is applied to the Data Link Receiver
- Ensure that nothing is plugged into the Aux Audio In jack because this would prevent SiriusXM radio from being heard

For troubleshooting purposes, check the LRU Information Box on the AUX - System Status Page for Data Link Receiver (GDL 69/69A) status, serial number, and software version number. If a failure has been detected in the GDL 69/69A the status is marked with a red X.

Selecting the AUX - System Status Page:

- 1) Turn the large **FMS** Knob to select the AUX Page Group.
- 2) Turn the small **FMS** Knob to select the AUX - System Status Page.

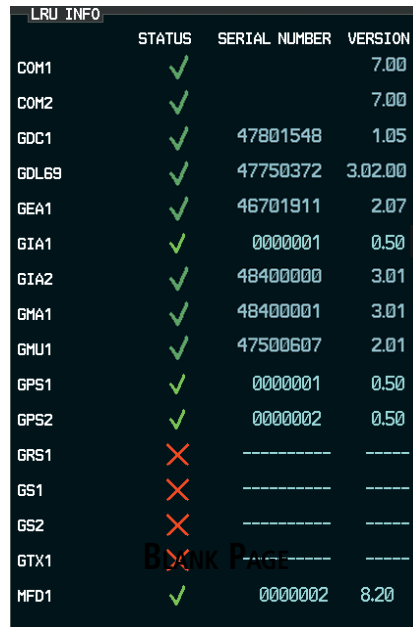

Figure 8-131 LRU Information Window on System Status Page

If a failure still exists, the following messages may provide insight as to the possible problem:

Message	Message Location	Description
CHECK ANTENNA	XM Information Page (MFD)	Data Link Receiver antenna error; service required
UPDATING	XM Information Page (MFD)	Data Link Receiver updating encryption code
NO SIGNAL	XM Information Page Weather Datalink Page (MFD)	Loss of signal; signal strength too low for receiver
LOADING	XM Radio Page (MFD)	Acquiring channel audio or information
OFF AIR	XM Radio Page (MFD)	Channel not in service
-----	XM Radio Page (MFD)	Missing channel information
WEATHER DATA LINK FAILED	Weather Datalink Page (MFD)	No communication from Data Link Receiver within last 5 minutes
ACTIVATION REQUIRED	XM Information Page (MFD)	SiriusXM subscription is not activated
DETECTING ACTIVATION	Weather Datalink Page (MFD)	SiriusXM subscription is activating.
WAITING FOR DATA...	Weather Datalink Page (MFD)	SiriusXM subscription confirmed downloading weather data.

Table 8-5 GDL 69/69A Data Link Receiver Messages

ANNUNCIATIONS AND ALERTS



NOTE: The current version of the pertinent flight manual supersedes information found in this document.

The Perspective Alerting System conveys alerts using the following:

- Annunciation Window:** The Annunciation Window displays abbreviated annunciation text. Text color is based on alert levels described in the following section. The Annunciation Window is located to the right of the Altimeter and Vertical Speed Indicator. All aircraft annunciations can be displayed simultaneously in the Annunciation Window. A white horizontal line separates annunciations that are acknowledged from annunciations that are not yet acknowledged. Higher priority annunciations are displayed towards the top of the window.
- Alerts Window:** The Alerts Window displays text messages for up to 64 prioritized alert messages. Pressing the **ALERTS** Softkey displays the Alerts Window. Pressing the **ALERTS** Softkey a second time removes the Alerts Window from the display. When the Alerts Window is displayed, the **FMS** Knob can be used to scroll through the alert message list.
- Softkey Annunciation:** During certain alerts, the **ALERTS** Softkey may appear as a flashing annunciation to accompany an alert. The **ALERTS** Softkey assumes a new label consistent with the alert level (WARNING, CAUTION, or ADVISORY). By selecting the softkey when flashing an annunciation, the alert is acknowledged. The softkey label then returns to **ALERTS**. If alerts are still present, the **ALERTS** label is displayed in white with black text. Selecting the **ALERTS** Softkey a second time views the alert text messages.
- System Annunciations:** Typically, a large red 'X' appears over instruments whose information is supplied by a failed Line Replaceable Unit (LRU). See the Perspective System Annunciations Section for more information.

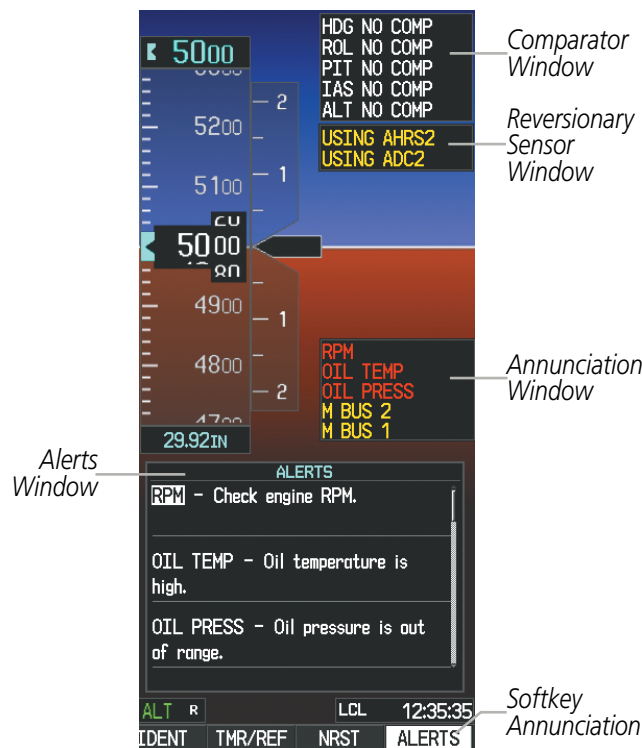

Figure A-1 Alerting System

- **Audio Alerting System:** The system issues audio alert tones when specific system conditions are met. See the Alert Level Definitions Section for more information. The annunciation tone may be tested from the AUX - System Status Page.

Testing the system annunciation tone:

- 1) Use the **FMS** Knob to select the AUX - System Status Page.
- 2) Select the **ANN TEST** Softkey.

Or:

- a) Press the **MENU** Key.
- b) Highlight 'Enable Annunciator Test Mode' and press the **ENT** Key.



Press to Test Annunciation Tone

Figure A-2 Annunciation Tone Testing
(AUX-System Status Page)

- **Comparator Window (Dual AHRS and/or Dual Air Data Computer installations only):** Critical values generated by redundant sensors are monitored by comparators. If differences in the sensors exceed a specified amount, the Comparator Window appears in the upper right corner of the PFD and the discrepancy is annunciated in the Comparator Window as a 'MISCOMP' (mismatch). If one or both of the sensed values are unavailable, it will be annunciated as a 'NO COMP' (no compare).



Figure A-3 Comparator Window

- **Reversionary Sensor Window (Dual AHRS and/or Dual Air Data Computer installations only):** Reversionary sensor selection is annunciated in a window on the right side of the PFD. These annunciations reflect reversionary sensors selected on the PFD. Pressing the **SENSOR** Softkey accesses the **ADC1**, **ADC2**, **AHRS1**, and **AHRS2** softkeys. These softkeys allow switching of the sensors being viewed on the PFD. The GPS sensor cannot be switched manually.



Figure A-4 Reversionary Sensor Window

ALERT LEVEL DEFINITIONS

The Perspective Alerting System uses three alert levels.

- **WARNING:** This level of alert requires immediate attention. Warning alert text is shown in red in the Annunciation Window and a flashing 'WARNING' Softkey annunciation. A repeating double chime accompanies select warning conditions. Pressing the **WARNING** Softkey acknowledges the presence of the warning alert and stops the chime (if present). Refer to Table A-1 for warning conditions and alerting behaviors.
- **CAUTION:** This level of alert indicates the existence of abnormal conditions on the aircraft that may require intervention. Caution alert text is shown in amber in the Annunciation Window and is accompanied by a flashing 'CAUTION' Softkey annunciation. A double chime lasting for one second occurs with select caution alerts. Pressing the **CAUTION** Softkey acknowledges the presence of the caution alert. Refer to Table A-2 for caution conditions and alerting behaviors.
- **ANNUNCIATION OR MESSAGE ADVISORY:** This level of alert provides general information. Annunciation alert text is shown in white in the Annunciation Window; no aural tone is generated with the exception of the 'OXYGEN LEFT ON' advisory alert, which produces a one second double chime. An annunciation alert is accompanied by a flashing **ADVISORY** Softkey annunciation. Pressing the **ADVISORY** Softkey acknowledges the presence of the annunciation alert. Refer to Table A-3 for annunciation alert conditions and behaviors.

Message advisory alerts do not issue annunciations in the Annunciation Window. Instead, message advisory alerts only issue a flashing 'ADVISORY' Softkey annunciation. Selecting the **ADVISORY** Softkey acknowledges the presence of the message advisory alert and displays the alert text message in the Alerts Window.



Figure A-5 Softkey Annunciation (ALERTS Softkey Labels)

AIRCRAFT ALERTS

The following alerts are configured specifically for the Cirrus SR2x models. Red annunciation window text signifies warnings and amber, cautions. See the current version of the pertinent flight manual for recommended pilot actions.



NOTE: The ice protection system (optional) must be operated in accordance with the approved flight manual limitations. This option is only available on the SR22 and SR22T models.

Annunciation Window Text	Alerts Window Text	Audio Alert
ANTI ICE CTL ☁	Tank valves cannot be controlled (closed) (TKS).	Repeating Double Chime
ANTI ICE FLOW ☁	Flow rate is low (TKS).	Repeating Double Chime
ANTI ICE QTY ☁	Left and right fluid quantities are unknown (TKS)	Repeating Double Chime
ANTI ICE QTY ☁ ☁	Fluid quantity is low (TKS).	Repeating Double Chime
AOA OVERHEAT ☁	AOA probe is overheated.	Repeating Double Chime
AUTO DESCENT †	Automatic descent to 14,000FT in 60 seconds.	Repeating Double Chime
AUTO DESCENT †	Aircraft descending to 14,000FT.	Repeating Double Chime
AUTO DESCENT †	Aircraft descending to 12,500FT.	Repeating Double Chime
AUTO DESCENT †	Aircraft descended due to pilot incapacitation.	Repeating Double Chime
BRAKE TEMP	Brake temperature is high.	Repeating Double Chime
CHT	Cylinder head temperature is high.	Repeating Double Chime
CO LVL HIGH	Carbon monoxide level is too high.	Repeating Double Chime
ESS BUS	Check essential power bus voltage.	Repeating Double Chime ¹
FLAPS ICE ☁ ☁	Full flaps prohibited in icing conditions.	Repeating Double Chime
FUEL FLOW *	Check fuel flow.	Repeating Double Chime
FUEL IMBALANCE	Fuel quantity imbalance has been detected.	Repeating Double Chime
FUEL QTY	Check fuel tank levels.	Repeating Double Chime
M BUS 1	Check main power bus 1 voltage.	Repeating Double Chime
M BUS 2	Check main power bus 2 voltage.	Repeating Double Chime
MAN PRESSURE *	Check manifold pressure.	Repeating Double Chime (after 30 seconds)
OIL PRESSURE	Oil pressure is out of range.	Repeating Double Chime ¹
OIL TEMP	Oil temperature is high.	Repeating Double Chime
OXYGEN FAULT †	Oxygen system fault.	Repeating Double Chime
OXYGEN QTY †	Oxygen quantity is low.	Repeating Double Chime
PITCH TRIM	Pitch Trim control has failed.	Repeating Double Chime
RPM	Check engine RPM.	Repeating Double Chime
SPIN SPIN SPIN	Spin entry detected.	"Spin Spin Spin" (repeating)
STALL	Stall warning.	"Stall" Repeating with Continuous Tone
STALL WARN FAIL	Stall warning is inoperative.	Repeating Double Chime
START ENGAGED	Starter is engaged.	Repeating Double Chime

Annunciation Window Text	Alerts Window Text	Audio Alert
TIT*	TIT temperature is high.	Repeating Double Chime
UNDERSPEED PROTECT ACTIVE†	None	"Airspeed"

✦ Optional / * Not applicable to all models / ▲ TKS NH (optional) / ☼ TKS FIKI (optional) / ¹ In air only / [^] SR22T only / † Garmin AFCS required

Table A-1 Warning Alerts

Annunciation Window Text	Alerts Window Text	Audio Alert
ALT 1	Check alternator 1 current.	Double Chime ¹
ALT 2	Check alternator 2 current.	Double Chime ¹
ALT AIR OPEN*	Alternate air door is open.	Double Chime
ANTI ICE HEAT ☁	Stall warning/AoA heater has failed.	Double Chime
ANTI ICE LEVEL ☁	Left tank fluid quantity is unreliable (TKS).	Double Chime
ANTI ICE LEVEL ☁	Right tank fluid quantity is unreliable (TKS).	Double Chime
ANTI ICE PRESS ☁	Tail pressure is low (TKS).	Double Chime
ANTI ICE PRESS ☁	Pressure is high (TKS).	Double Chime
ANTI ICE QTY ☁	Fluid quantity imbalance has been detected (TKS)	Double Chime
ANTI ICE QTY ☁☁	Fluid quantity is low (TKS)	Double Chime
ANTI ICE SPEED ☁	Airspeed is too low for ice protection (TKS).	Double Chime ¹
ANTI ICE SPEED ☁	Airspeed is too high for ice protection (TKS).	Double Chime ¹
ANTI ICE TEMP ☁	Temperature is too low for ice protection (TKS)	None
AP MISCOMPARE †	Autopilot miscompare, autopilot is not available.	Double Chime
AP/PFD DIF ADC †	Autopilot and PFD are using different ADCs.	Double Chime
AP/PFD DIF AHRS †	Autopilot and PFD are using different AHRSs.	Double Chime
AVIONICS OFF	Avionics master switch is off.	Double Chime
BATT 1	Check battery 1 current.	Double Chime ¹
BRAKE TEMP	Brake temperature is high.	Double Chime
CHT	Cylinder head temperature is high.	Double Chime
FLAP OVERSPEED	Flaps are extended beyond airspeed limitations.	Double Chime
FUEL FILTER	Fuel filter in bypass	Double Chime
FUEL IMBALANCE	Fuel quantity imbalance has been detected.	None
FUEL QTY	Check fuel tank levels.	Double Chime
HYPOXIA ALERT †	Hypoxia caution alert.	Double Chime
LRG MAG VAR	The GDU's internal model cannot determine the exact magnetic variance for geographic locations near the magnetic poles. Displayed magnetic course angles may differ from the actual magnetic heading by more than 2°.	Double Chime
M BUS 1	Check main power bus 1.	Double Chime ¹
M BUS 2	Check main power bus 2.	Double Chime ¹

SYSTEM OVERVIEW

FLIGHT INSTRUMENTS

EIS

AUDIO PANEL & CNS

FLIGHT MANAGEMENT

HAZARD AVOIDANCE

AFCS

ADDITIONAL FEATURES

APPENDICES

INDEX

Annunciation Window Text	Alerts Window Text	Audio Alert
MAN PRESSURE*	Check manifold pressure.	None
NO ADC MODES[‡]	Autopilot air data modes are not available.	Double Chime
NO VERT MODES[‡]	Autopilot vertical modes are not available.	Double Chime
OIL PRESSURE	Oil pressure is out of range.	Double Chime ¹
OIL TEMP	Oil temperature is high.	Double Chime
OXYGEN QTY[‡]	Oxygen quantity is low.	Double Chime
OXYGEN RQD[‡]	Oxygen is required.	Double Chime
PARK BRAKE	Parking break is set.	None
PITOT HEAT FAIL	Pitot heat failure.	Double Chime
PITOT HEAT REQD	Pitot heat is required.	Double Chime ¹
SLCT MAG	The system notifies the pilot to set the Nav Angle units on the Avioncs Settings Screen to Magnetic.	Double Chime
SLCT NON-MAG	The system notifies the pilot to set the Nav Angle units on the Avioncs Settings Screen to True.	Double Chime
START ENGAGED	Starter is engaged.	Double Chime
TAKEOFF FLAPS	Flaps not in takeoff configuration	Double Chime

[‡] Optional / * Not applicable to all models / [☂] TKS NH (optional) / [☂] TKS FIKI (optional) / ¹ In air only / [†] Garmin AFCS required

Table A-2 Caution Alerts



NOTE: The ice protection system (optional) must be operated in accordance with the approved flight manual limitations. This option is only available on SR22 and SR22T models.

Annunciation Window Text	Alerts Window Text	Audio Alert
ALTITUDE SEL[‡]	Climbing away from selected altitude.	None
ALTITUDE SEL[‡]	Descending away from selected altitude.	None
AOA FAIL[☂]	Dynamic stall speed band is not available.	None
ARE YOU ALERT?[†]	Are you alert?	None
COURSE SEL[‡]	Current track will not intercept selected course.	None
CHECK FUEL[§]	Fuel quantity imbalance has been detected.	None
FUEL IMBALANCE[^]	Fuel quantity imbalance has been detected.	None
HIGH MP FF[*]	Avoid fuel flow 18 to 30 GPH and MP above 26".	None
L FUEL QTY	Check left fuel tank level.	None
OXYGEN LEFT ON[‡]	Oxygen system is left on after shutdown.	Double Chime
OXYGEN QTY[‡]	Oxygen quantity is low.	None
PUMP BACKUP[☂]	Anti-ice backup pump mode has been selected (TKS).	None
R FUEL QTY	Check right fuel tank level.	None
ROL MODE	Roll mode is active.	None

[‡] Optional / * Not applicable to all models / [☂] TKS FIKI (optional) / [†] Garmin AFCS required / [^] SR22 models only / [§] SR20 model only

Table A-3 Advisory Alerts

Comparator Window Text	Condition
ALT MISCOMP	Difference in altitude sensors is ≥ 200 ft.
IAS MISCOMP	If both airspeed sensors detect < 35 knots, this is inhibited.
	If either airspeed sensor detects ≥ 35 knots, and the difference in sensors is > 10 kts.
HDG MISCOMP	If either airspeed sensor detects ≥ 80 knots, and the difference in sensors is > 7 kts.
	Difference in heading sensors is > 6 degrees.
PIT MISCOMP	Difference in pitch sensors is > 5 degrees.
ROL MISCOMP	Difference in roll sensors is > 6 degrees.
ALT NO COMP	No data from one or both altitude sensors.
IAS NO COMP	No data from one or both airspeed sensors.
HDG NO COMP	No data from one or both heading sensors.
PIT NO COMP	No data from one or both pitch sensors.
ROL NO COMP	No data from one or both roll sensors.

Table A-4 Comparator Alerts (Dual AHRS and/or Dual Air Data Computer installations only)

Reversionary Sensor Window Text	Condition
USING ADC2	The PFD is displaying data from the #2 Air Data Computer (dual ADC installations only).
USING AHRS2	The PFD is displaying data from the #2 AHRS (dual AHRS installations only).

Table A-5 Reversionary Sensor Alerts (Dual AHRS and/or Dual Air Data Computer installations only)



NOTE: The ice protection system (optional) must be operated in accordance with the approved flight manual limitations. This option is only available on the SR22 and SR22T models.

Alerts Window Message	Audio Alert
ANTI ICE QTY – Fluid quantity is low (TKS)	None
CO DET FAIL – The carbon monoxide detector is inoperative	
CO DET SRVC – The carbon monoxide detector needs service	
ESP CONFIG † – ESP config error. Config service req'd.	
ESP FAIL † – ESP is inoperative.	
ESP OFF † – ESP selected off.	
ESP DEGRADE † – ESP IAS mode is inoperative.	
EXIT ICING – Exit icing conditions	
FAILED PATH – An autopilot servo data path has failed	
MFD FAN FAIL – MFD cooling fan is inoperative.	
PFD FAN FAIL – PFD cooling fan is inoperative.	

Optional/ TKS NH (optional)/ TKS FIKI (optional)/ † Garmin AFCS required

Table A-6 Message Advisory Alerts

PERSPECTIVE VOICE ALERTS

The following audio alerts are announced by the system using a voice of male or female gender. If the optional Terrain Awareness and Warning System is installed, voice alerts are also generated (refer to the TAWS Alerts section).

Voice Alert	Alert Trigger
"Minimums, Minimums"	Issued when the aircraft transitions through the minimum descent altitude/decision height (MDA/DH)
"Vertical Track"	Aircraft is one minute from Top of Descent - issued only when vertical navigation is enabled
"Airspeed"	Issued when the airspeed is low and the autopilot is engaged
"Altitude"	Issued when the aircraft transitions beyond the set altitude limit
"Six-Hundred"	Aircraft has ascended to 600 feet above the terrain based on GSL altitude and the terrain database

Table A-7 Voice Alerts

Selecting the audio alert voice:

- 1) Use the **FMS** Knob to select the AUX - System Setup 1 Page.
- 2) Push the **FMS** Knob to activate the cursor.
- 3) Turn the large **FMS** Knob to highlight the voice in the Audio Alert Box.
- 4) Turn the small **FMS** Knob to select the desired voice, press the ENT Key.

GTS 800 TRAFFIC ADVISORY SYSTEM VOICE ALERTS

The optional GTS 800 Traffic Advisory System (TAS) issues alerts using a male or female voice. The voice alert gender is configured at installation.

Voice Alert	Alert Trigger
"TAS System Test Passed"	The traffic system has passed a pilot-initiated system test.
"TAS System Test Failed"	The traffic system has failed a pilot-initiated system test.
"Traffic"	Issued each time a new traffic advisory (TA) occurs.

Table A-8 GTS 800 System Voice Alerts

Each time a new traffic advisory occurs, the GTS 800 system provides descriptive voice information to assist the pilot in visually locating TA traffic in the following format: Bearing, Relative Altitude, Distance.

Bearing	Relative Altitude	Distance (nm)
"One o'clock" through "Twelve o'clock" or "No Bearing"	"High", "Low", "Same Altitude" (if within 200 feet of own altitude), or "Altitude not available"	"Less than one mile", "One Mile" through "Ten Miles", or "More than ten miles"

Table A-9 GTS 800 Descriptive TA Voice Alerts

SYSTEM ANNUNCIATIONS

NOTE: Upon power-up, certain windows remain invalid as Perspective equipment begins to initialize. All windows should be operational within one minute of power-up. If any window continues to remain flagged, the Perspective System should be serviced by a Garmin-authorized repair facility.

When an LRU or an LRU function fails, a large red 'X' is typically displayed on windows associated with the failed data (refer to Figure B-1 for all possible flags and the responsible LRUs). Refer to the current version of the pertinent flight manual for additional information regarding pilot responses to these annunciations.

GIA 63W Integrated Avionics Units

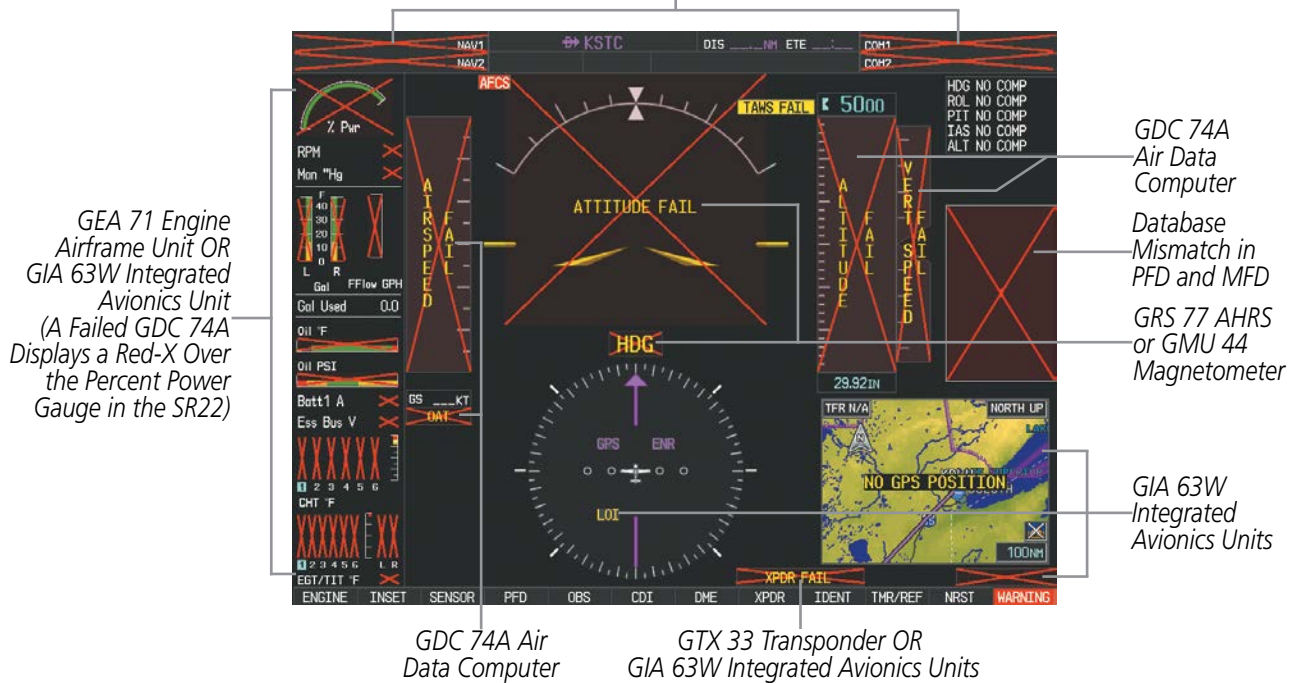

Figure A-6 System Failure Annunciations

The status of detected LRUs can be checked on the AUX - System Status Page (Figure A-2). Active LRUs are indicated by green check marks; failed, by red 'X's. Failed LRUs should be noted and a service center or Garmin-authorized dealer informed.

Viewing LRU information:

- 1) Use the **FMS** Knob to select the AUX - System Status Page.
- 2) To place the cursor in the 'LRU Info' Box,
 - a) Select the **LRU** Softkey.
 - Or:
 - a) Press the **MENU** Key.
 - b) With 'Select LRU Window' highlighted, press the **ENT** Key.
- 3) Use the **FMS** Knob to scroll through the box to view LRU status information.

SYSTEM OVERVIEW

FLIGHT INSTRUMENTS

EIS

AUDIO PANEL & CNS

FLIGHT MANAGEMENT







HAZARD AVOIDANCE





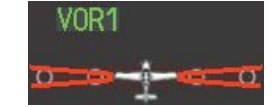

AFCS

ADDITIONAL FEATURES

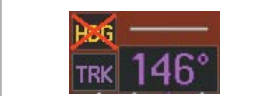
APPENDICES

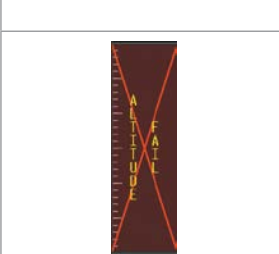
INDEX

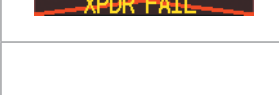
System Annunciation	Comment
	Attitude and Heading Reference System is aligning.
	Display system is not receiving attitude information from the AHRS.
	AHRS calibration incomplete or configuration module failure.
	This annunciation is seen only when the autopilot is engaged. The annunciation indicates an AHRS monitor has detected an abnormal flight parameter, possibly caused by strong turbulence. In this case, the situation should correct itself within a few seconds. If there is an actual failure, a red "X" soon appears over the Attitude Indicator.
	GPS information is either not present or is invalid for navigation use. Note that AHRS utilizes GPS inputs during normal operation. AHRS operation may be degraded if GPS signals are not present (see the current version of the pertinent flight manual).
	CDI is not receiving valid data from the corresponding GIA. Does not apply when the CDI is set to GPS.
	Display system is not receiving airspeed input from air data computer.

System Annunciation	Comment
	Display system is not receiving vertical speed input from the air data computer.
	System is not receiving valid heading input from GMU, but is receiving GPS-derived track information.
	System is not receiving valid heading input from GMU and is not receiving GPS-derived track information.
	Display system is not receiving altitude input from the air data computer.
	Display system is not receiving valid true airspeed information from air data computer.
	Display system is not receiving valid OAT information from air data computer.
	Display system is not receiving valid transponder information.
	Different versions of GDU software are installed in the PFD and MFD. This can also indicate different versions of the navigation database installed in the PFD and MFD. A cross-talk error between the PFD and MFD will also cause this annunciation.
Other Various Red X Indications	A red 'X' through any other display field (such as engine instrumentation fields) indicates that the field is not receiving valid data.

SYSTEM MESSAGE ADVISORIES



NOTE: This section provides information regarding Perspective message advisories that may be displayed by the system. Knowledge of the aircraft, systems, flight conditions, and other existing operational priorities must be considered when responding to a message.

This section describes various Perspective System message advisories. Certain messages are issued due to an LRU or LRU function fault. Such messages are normally accompanied by a corresponding red 'X' annunciation as shown previously in the Perspective System Annunciations section.

Message	Comments
ABORT APR – Loss of GPS navigation. Abort approach.	Abort approach due to loss of GPS navigation.
ADC1 ALT EC – ADC1 altitude error correction is unavailable.	GDC1 or GDC2 is reporting that the altitude error correction is unavailable.
ADC2 ALT EC – ADC2 altitude error correction is unavailable.	
ADC1 AS EC – ADC1 airspeed error correction is unavailable.	GDC1 or GDC2 is reporting that the airspeed error correction is unavailable.
ADC2 AS EC – ADC2 airspeed error correction is unavailable.	
AHRS1 TAS – AHRS1 not receiving valid airspeed.	The #1 AHRS is not receiving true airspeed from the air data computer. The AHRS relies on GPS information to augment the lack of airspeed. The Perspective system should be serviced.
AHRS2 TAS – AHRS2 not receiving valid airspeed.	The #2 AHRS is not receiving true airspeed from the air data computer. The AHRS relies on GPS information to augment the lack of airspeed. The Perspective system should be serviced.
AHRS1 GPS – AHRS1 using backup GPS source.	The #1 AHRS is using the backup GPS path. Primary GPS path has failed. The Perspective system should be serviced when possible.
AHRS2 GPS – AHRS2 using backup GPS source.	The #2 AHRS is using the backup GPS path. Primary GPS path has failed. The Perspective system should be serviced when possible.
AHRS1 GPS – AHRS1 not receiving any GPS information.	The #1 AHRS is not receiving any or any useful GPS information. Check the current version of the pertinent flight manual limitations. The Perspective system should be serviced.
AHRS2 GPS – AHRS2 not receiving any GPS information.	The #2 AHRS is not receiving any or any useful GPS information. Check the current version of the pertinent flight manual limitations. The Perspective system should be serviced.
AHRS1 GPS – AHRS1 not receiving backup GPS information.	The #1 AHRS is not receiving backup GPS information. The Perspective system should be serviced.
AHRS2 GPS – AHRS2 not receiving backup GPS information.	The #2 AHRS is not receiving backup GPS information. The Perspective system should be serviced.
AHRS1 GPS – AHRS1 operating exclusively in no-GPS mode.	The #1 AHRS is operating exclusively in no-GPS mode. The Perspective system should be serviced.
AHRS2 GPS – AHRS2 operating exclusively in no-GPS mode.	The #2 AHRS is operating exclusively in no-GPS mode. The Perspective system should be serviced.
AHRS MAG DB – AHRS magnetic model database version mismatch.	The #1 AHRS earth magnetic field model is out of date. Update magnetic field model when practical.

SYSTEM OVERVIEW

FLIGHT INSTRUMENTS

EIS

AUDIO PANEL & CNS

FLIGHT MANAGEMENT

HAZARD AVOIDANCE

AFCS

ADDITIONAL FEATURES

APPENDICES

INDEX

Message	Comments
AHRS1 SRVC – AHRS1 Magnetic-field model needs update.	The #1 AHRS earth magnetic field model is out of date. Update magnetic field model when practical.
AHRS2 SRVC – AHRS2 Magnetic-field model needs update.	The #2 AHRS earth magnetic field model is out of date. Update magnetic field model when practical.
APPR INACTV – Approach is not active.	The system notifies the pilot that the loaded approach is not active. Activate approach when required.
APR DWNGRADE – Approach downgraded.	Vertical guidance generated by SBAS is unavailable, use LNAV only minimums.
ARSPC AHEAD – Airspace ahead less than 10 minutes.	Special use airspace is ahead of aircraft. The aircraft will penetrate the airspace within 10 minutes.
ARSPC NEAR – Airspace near and ahead.	Special use airspace is near and ahead of the aircraft position.
ARSPC NEAR – Airspace near – less than 2 nm.	Special use airspace is within 2 nm of the aircraft position.
CHECK CRS – Database course for LOC1 / [LOC ID] is [CRS]°.	Selected course for LOC1 differs from published localizer course by more than 10 degrees.
CHECK CRS – Database course for LOC2 / [LOC ID] is [CRS]°.	Selected course for LOC2 differs from published localizer course by more than 10 degrees.
CNFG MODULE – PFD1 configuration module is inoperative.	The PFD1 configuration module backup memory has failed. The system should be serviced.
COM1 CONFIG – COM1 config error. Config service req'd.	The COM1 and/or COM2 configuration settings do not match backup configuration memory. The system should be serviced.
COM2 CONFIG – COM2 config error. Config service req'd.	
COM1 PTT – COM1 push-to-talk key is stuck.	The COM1 and/or COM2 external push-to-talk switch is stuck in the enable (or “pressed”) position. Press the PTT switch again to cycle its operation. If the problem persists, the system should be serviced.
COM2 PTT – COM2 push-to-talk key is stuck.	
COM1 RMT XFR – COM1 remote transfer key is stuck.	The COM1 and/or COM2 transfer switch is stuck in the enabled (or “pressed”) position. Press the transfer switch again to cycle its operation. If the problem persists, the system should be serviced.
COM2 RMT XFR – COM2 remote transfer key is stuck.	
COM1 SERVICE – COM1 needs service. Return unit for repair.	The system has detected a fault in COM1 and/or COM2. COM1 and/or COM2 may still be usable. The system should be serviced when possible.
COM2 SERVICE – COM2 needs service. Return unit for repair.	
COM1 TEMP – COM1 over temp. Reducing transmitter power.	The system has detected an over temperature condition in COM1 and/or COM2. The transmitter operates at reduced power. If the problem persists, the system should be serviced.
COM2 TEMP – COM2 over temp. Reducing transmitter power.	
DATA LOST – Pilot stored data was lost. Recheck settings.	The pilot profile data was lost. System reverts to default pilot profile and settings. The pilot may reconfigure the MFD & PFD with preferred settings, if desired.
DB CHANGE – Database changed. Verify user modified procedures.	This occurs when a stored flight plan contains an airway that is no longer consistent with the navigation database. This alert is issued only after an navigation database update. Verify that the user-modified procedures in stored flight plans are correct and up to date.

Message	Comments
DB CHANGE – Database changed. Verify stored airways.	This occurs when a stored flight plan contains an airway that is no longer consistent with the navigation database. This alert is issued only after an navigation database update. Verify use of airways in stored flight plans and reload airways as needed.
DB MISMATCH – Navigation database mismatch. Xtalk is off.	The PFD and MFD have different navigation database versions or regions installed. Crossfill is off. Check the AUX-SYSTEM STATUS Page to determine versions or regions. Also, check the AUX-SYSTEM STATUS Page for a database synchronization function not completed. After synchronization is complete, power must be turned off, then on.
DB MISMATCH – Standby Navigation database mismatch.	The PFD and MFD have different standby navigation database versions or regions installed. Check the AUX-SYSTEM STATUS Page to determine versions or regions. Also, check the AUX-SYSTEM STATUS Page for a database synchronization function not completed. After synchronization is complete, power must be turned off, then on.
DB MISMATCH – Terrain database mismatch.	The PFD and MFD have different terrain database versions or regions installed. Check the AUX-SYSTEM STATUS Page to determine versions or regions. Also, check the AUX-SYSTEM STATUS Page for a database synchronization function not completed. After synchronization is complete, power must be turned off, then on.
DB MISMATCH – Obstacle database mismatch.	The PFD and MFD have different obstacle database versions or regions installed. Check the AUX-SYSTEM STATUS Page to determine versions or regions. Also, check the AUX-SYSTEM STATUS Page for a database synchronization function not completed. After synchronization is complete, power must be turned off, then on.
FAILED PATH – A data path has failed.	A data path connected to the GDU or the GIA 63/W has failed.
FPL WPT LOCK – Flight plan waypoint is locked.	Upon power-up, the system detects that a stored flight plan waypoint is locked. This occurs when an navigation database update eliminates an obsolete waypoint. The flight plan cannot find the specified waypoint and flags this message. This can also occur with user waypoints in a flight plan that is deleted. Remove the waypoint from the flight plan if it no longer exists in any database, Or Update the waypoint name/identifier to reflect the new information.
FPL WPT MOVE – Flight plan waypoint moved.	The system has detected that a waypoint coordinate has changed due to a new navigation database update. Verify that stored flight plans contain correct waypoint locations.
FPL TRUNC – Flight plan has been truncated.	This occurs when a newly installed navigation database eliminates an obsolete approach or arrival used by a stored flight plan. The obsolete procedure is removed from the flight plan. Update flight plan with current arrival or approach.
GCU CNFG – GCU Config error. Config service req'd.	GCU 478 configuration settings do not match those of backup configuration memory. The Perspective system should be serviced.
GCU FAIL – GCU is inoperative.	A fault has been detected in the GCU 478. The GCU 478 is unavailable.
GCU FAIL – GCU is inoperative.	A fault has been detected in the GMC 705. The GMC 705 is unavailable.
GCU KEYSTK – GCU [key name] Key is stuck.	A key is stuck on the GCU 478 bezel. Attempt to free the stuck key by pressing it several times. The Perspective system should be serviced if the problem persists.
GCU KEYSTK – GCU [key name] Key is stuck.	A key is stuck on the GMC 705 bezel. Attempt to free the stuck key by pressing it several times. The Perspective system should be serviced if the problem persists.
GDL59 CONFIG – GDL 59 config error. Config service req'd.	GDL 59 configuration settings do not match those of backup configuration memory. The system should be serviced.
GDL59 FAIL – GDL 59 has failed.	A fault has been detected in the GDL 59. The receiver is unavailable. The system should be serviced.
GDL59 SERVICE – GDL 59 needs service. Return unit for repair.	A fault has been detected in the GDL 59. The system should be serviced.

SYSTEM OVERVIEW

FLIGHT INSTRUMENTS

EIS

AUDIO PANEL & CNS

FLIGHT MANAGEMENT

HAZARD AVOIDANCE

AFCS

ADDITIONAL FEATURES

APPENDICES

INDEX

Message	Comments
GDL59 RTR FAIL – The GDL 59 router has failed.	A fault has been detected in the GDL 59 router. The system should be serviced.
GDL69 CONFIG – GDL 69 config error. Config service req'd.	GDL 69 configuration settings do not match those of backup configuration memory. The system should be serviced.
GDL69 FAIL – GDL 69 has failed.	A fault has been detected in the GDL 69. The receiver is unavailable. The system should be serviced.
GDL88 ADS-B 1090 - ADS-B fault. 1090 receiver failure.	A failure has been detected in the 1090 receiver.
GDL88 ADS-B NO POS - GDL88 is not receiving position information.	The GDL 88 is not able to receive position information.
GDL88 ADS-B NO TX - GDL88 Failure	Unable to transmit GDL 88 messages.
GDL88 ADS-B TRFC - GDL 88 ADS-B traffic has failed	The GDL 88 is incapable of processing traffic information.
GDL88 ADS-B UAT - ADS-B fault. UAT receiver failure.	A failure has been detected in the UAT receiver.
GDL88 ANTENNA - GDL 88 Antenna fault	The GDL 88 Antenna has failed.
GDL88 CONFIG – GDL88 config error.	The GDL 88 and GDU have incompatible configurations. This alert is also set when the GDL 88 has an invalid mode S address configured or the mode S address does not match both XPDR mode S addresses.
GDL88 CSA FAIL -- ADS-B Airborne alerts failure.	GDL 88 ADS-B Conflict Situational Awareness (CSA) is unavailable.
GDL88 FAIL - Unable to transmit ADS-B messages.	The PFD has lost connection with the GDL 88.
GDL88 PRES ALT - GDL88 is not receiving pressure altitude.	The GDL 88 is not receiving pressure altitude data.
GDL88 SERVICE – GDL88 needs service.	Return unit for repair.
GDL88 XPDR - GDL88 not receiving XPDR code. Check XPDR mode.	The GDL 88 is not receiving transponder code. The transponder should be in ALT mode when airborne.
GEA1 CONFIG – GEA1 config error. Config service req'd.	The GEA1 configuration settings do not match those of backup configuration memory. The system should be serviced.
GEO LIMITS – AHRS1 too far North/South, no magnetic compass.	The aircraft is outside geographical limits for approved AHRS operation. Heading is flagged as invalid.
GEO LIMITS – AHRS2 too far North/South, no magnetic compass.	
GIA1 CONFIG – GIA1 config error. Config service req'd.	The GIA1 and/or GIA2 configuration settings do not match backup configuration memory. The system should be serviced.
GIA2 CONFIG – GIA2 config error. Config service req'd.	
GIA1 CONFIG – GIA1 audio config error. Config service req'd.	The GIA1 and/or GIA2 have an error in the audio configuration. The system should be serviced.
GIA2 CONFIG – GIA2 audio config error. Config service req'd.	

Message	Comments
GIA1 COOLING – GIA1 temperature too low.	The GIA1 and/or GIA2 temperature is too low to operate correctly. Allow units to warm up to operating temperature.
GIA2 COOLING – GIA2 temperature too low.	
GIA1 COOLING – GIA1 over temperature.	The GIA1 and/or GIA2 temperature is too high. If problem persists, the system should be serviced.
GIA2 COOLING – GIA2 over temperature.	
GIA1 SERVICE – GIA1 needs service. Return the unit for repair.	The GIA1 and/or GIA2 self-test has detected a problem in the unit. The system should be serviced.
GIA2 SERVICE – GIA2 needs service. Return the unit for repair.	
GMA1 CONFIG – GMA1 config error. Config service req'd.	The audio panel configuration settings do not match backup configuration memory. The Perspective system should be serviced.
GMA1 FAIL – GMA1 is inoperative.	The audio panel self-test has detected a fault. The audio panel is unavailable. The Perspective system should be serviced.
GMA1 SERVICE – GMA1 needs service. Return unit for repair.	The audio panel self-test has detected a problem in the unit. Certain audio functions may still be available, and the audio panel may still be usable. The Perspective system should be serviced when possible.
GMC CONFIG – GMC Config error. Config service req'd.	Error in the configuration of the GMC 705.
GPS NAV LOST – Loss of GPS navigation. Insufficient satellites.	Loss of GPS navigation due to insufficient satellites.
GPS NAV LOST – Loss of GPS navigation. Position error.	Loss of GPS navigation due to position error.
GPS NAV LOST – Loss of GPS navigation. GPS fail.	Loss of GPS navigation due to GPS fault.
GPS1 SERVICE – GPS1 needs service. Return unit for repair.	A fault has been detected in the GPS1 and/or GPS2 receiver. The receiver may still be available. The system should be serviced.
GPS2 SERVICE – GPS2 needs service. Return unit for repair.	
G/S1 FAIL – G/S1 is inoperative.	A fault has been detected in glideslope receiver 1 and/or receiver 2. The system should be serviced.
G/S2 FAIL – G/S2 is inoperative.	
G/S1 SERVICE – G/S1 needs service. Return unit for repair.	A fault has been detected in glideslope receiver 1 and/or receiver 2. The receiver may still be available. The system should be serviced when possible.
G/S2 SERVICE – G/S2 needs service. Return unit for repair.	
GSR1 FAIL – GSR1 has failed.	A fault has been detected in the GSR 56. The transceiver is unavailable. The Perspective system should be serviced.
GTS CONFIG – GTS Config error. Config service req'd.	The GTS and GDU have different copies of the GTS configuration, or the Mode S address is invalid. The Perspective system should be serviced.
HDG FAULT – AHRS1 magnetometer fault has occurred.	A fault has occurred in the #1 GMU 44. Heading is flagged as invalid. The AHRS uses GPS for backup mode operation. The Perspective system should be serviced.

Message	Comments
HDG FAULT – AHRS2 magnetometer fault has occurred.	A fault has occurred in the #2 GMU 44. Heading is flagged as invalid. The AHRS uses GPS for backup mode operation. The Perspective system should be serviced.
HOLD EXPIRED – Holding EFC time expired.	Expect Further Clearance (EFC) time has expired for the User Defined Hold.
HW MISMATCH – GIA hardware mismatch. GIA1 communication halted.	A GIA mismatch has been detected, where only one is SBAS capable.
HW MISMATCH – GIA hardware mismatch. GIA2 communication halted.	
INSIDE ARSPC – Inside airspace.	The aircraft is inside the airspace.
INVALID ADM – Invalid ADM: ATN communication halted.	Data link avionics were not configured correctly and therefore will not be able to communicate with the ground network.
LOCKED FPL – Cannot navigate locked flight plan.	This occurs when the pilot attempts to activate a stored flight plan that contains locked waypoint. Remove locked waypoint from flight plan. Update flight plan with current waypoint.
LOI – GPS integrity lost. Crosscheck with other NAVS.	GPS integrity is insufficient for the current phase of flight.
MANIFEST – COM1 software mismatch, communication halted.	COM1 and/or COM2 software mismatch. The system should be serviced.
MANIFEST – COM2 software mismatch, communication halted.	
MANIFEST – GCU software mismatch, communication halted.	The GCU 478 has incorrect software installed. The Perspective system should be serviced.
MANIFEST – GDC1 software mismatch, communication halted.	The GDC 74A has incorrect software installed. The Perspective system should be serviced.
MANIFEST – GDC2 software mismatch, communication halted.	
MANIFEST – GDL software mismatch, communication halted.	The GDL 69 has incorrect software installed. The system should be serviced.
MANIFEST – GDL software mismatch, communication halted.	The GDL 59 has incorrect software installed. The system should be serviced.
MANIFEST – GEA1 software mismatch, communication halted.	The #1 GEA 71 has incorrect software installed. The system should be serviced.
MANIFEST – GFC software mismatch, communication halted.	Incorrect servo software is installed, or gain settings are incorrect.
MANIFEST – GIA1 software mismatch, communication halted.	The GIA1 and/or GIA 2 has incorrect software installed. The system should be serviced.
MANIFEST – GIA2 software mismatch, communication halted.	
MANIFEST – GMA1 software mismatch, communication halted.	The audio panel has incorrect software installed. The Perspective system should be serviced.
MANIFEST – GMC software mismatch, communication halted.	The GMC 705 has incorrect software installed. The Perspective system should be serviced.

Message	Comments
MANIFEST – GMU1 software mismatch, communication halted.	The GMU 44 has incorrect software installed. The Perspective system should be serviced.
MANIFEST – GMU2 software mismatch, communication halted.	
MANIFEST – GRS1 software mismatch, communication halted.	The #1 AHRS has incorrect software installed. The Perspective system should be serviced.
MANIFEST – GRS2 software mismatch, communication halted.	The #2 AHRS has incorrect software installed. The Perspective system should be serviced.
MANIFEST – GTS software mismatch, communication halted.	The GTS has incorrect software installed. The Perspective system should be serviced.
MANIFEST – GTX1 software mismatch, communication halted.	The transponder has incorrect software installed. The Perspective system should be serviced.
MANIFEST – NAV1 software mismatch, communication halted.	NAV1 and/or NAV2 software mismatch. The system should be serviced.
MANIFEST – NAV2 software mismatch, communication halted.	
MANIFEST – PFD1 software mismatch, communication halted.	The PFD and/or MFD has incorrect software installed. The system should be serviced.
MANIFEST – MFD1 software mismatch, communication halted.	
MFD1 CONFIG – MFD1 configuration error. Config service req'd.	The MFD configuration settings do not match backup configuration memory. The system should be serviced.
MFD1 COOLING – MFD1 has poor cooling. Reducing power usage.	The MFD is overheating and is reducing power consumption by dimming the display. If problem persists, the system should be serviced.
MFD1 DB ERR – MFD1 Airport Directory database error exists.	The MFD detected a fault in the Airport Directory database. Ensure the data card is properly inserted. Replace data card. If problem persists, the system should be serviced.
MFD1 DB ERR – MFD1 basemap database error exists.	The MFD PFD detected a fault in the basemap database.
MFD1 DB ERR – MFD1 basemap database is incompatible.	The MFD detected a that the basemap database is incompatible.
MFD1 DB ERR – MFD1 navigation database error exists.	The MFD detected a fault in the navigation database. Attempt to reload the navigation database. If problem persists, the system should be serviced.
MFD1 DB ERR – MFD1 terrain database error exists.	The MFD detected a fault in the terrain database. Ensure that the terrain card is properly inserted in display. Replace terrain card. If problem persists, the system should be serviced.
MFD1 DB ERR – MFD1 terrain database missing.	The terrain database is present on another LRU, but is missing on the specified LRU.
MFD1 DB ERR – MFD1 obstacle database error exists.	The MFD detected a fault in the obstacle database. Ensure that the data card is properly inserted. Replace data card. If problem persists, the system should be serviced.
MFD1 DB ERR – MFD1 obstacle database missing.	The obstacle database is present on another LRU, but is missing on the specified LRU.
MFD1 DB ERR – MFD1 Safe Taxi database error exists.	The MFD detected a fault in the Safe Taxi database. Ensure that the data card is properly inserted. Replace data card. If problem persists, the system should be serviced.

SYSTEM OVERVIEW

FLIGHT INSTRUMENTS

EIS

AUDIO PANEL & CNS

FLIGHT MANAGEMENT

HAZARD AVOIDANCE

AFCS

ADDITIONAL FEATURES

APPENDICES

INDEX

Message	Comments
MFD1 DB ERR – MFD1 FliteCharts database error exists.	The MFD detected a fault in the FliteCharts database (optional feature). Ensure the data card is properly inserted. Replace data card. If problem persists, the system should be serviced.
MFD1 DB ERR – MFD1 Chartview database error exists.	The MFD detected a fault in the ChartView database (optional feature). Ensure the data card is properly inserted. Replace data card. If the problem persists, the system should be serviced.
MFD1 DB ERR – MFD1 multiple database errors exists.	The MFD detected a fault in more than one database. If problem persists, the system should be serviced.
MFD1 SERVICE – MFD1 needs service. Return unit for repair.	The MFD self-test has detected a problem. The system should be serviced.
MFD1 VOLTAGE – MFD1 has low voltage. Reducing power usage.	The MFD voltage is low. The system should be serviced.
NAV DB UPDATED – Active navigation database updated.	System has updated the active navigation database from the standby navigation database.
NAV1 SERVICE – NAV1 needs service. Return unit for repair.	A fault has been detected in the NAV1 and/or NAV2 receiver. The receiver may still be available. The system should be serviced.
NAV2 SERVICE – NAV2 needs service. Return unit for repair.	
NAV1 RMT XFR – NAV1 remote transfer key is stuck.	The remote NAV1 and/or NAV2 transfer switch is stuck in the enabled (or “pressed”) state. Press the transfer switch again to cycle its operation. If the problem persists, the system should be serviced.
NAV2 RMT XFR – NAV2 remote transfer key is stuck.	
NON-MAG UNITS – Non-magnetic NAV ANGLE display units are active.	Navigation angle is not set to MAGNETIC at power-up.
NON WGS84 WPT – Do not use GPS navigation to [xxxx].	The position of the selected waypoint [xxxx] is not calculated based on the WGS84 map reference datum and may be positioned in error as displayed. Do not use GPS to navigate to the selected non-WGS84 waypoint.
PFD1 DB ERR – PFD1 Airport Directory database error exists.	The PFD detected a fault in the Airport Directory database. Ensure the data card is properly inserted. Replace data card. If problem persists, the system should be serviced.
PFD1 DB ERR – PFD1 basemap database error exists.	The PFD detected a fault in the basemap database.
PFD1 DB ERR – PFD1 basemap database is incompatible.	The PFD detected a that the basemap database is incompatible.
PFD1 DB ERR – PFD1 navigation database error exists.	The PFD detected a fault in the navigation database. Attempt to reload the navigation database. If problem persists, the system should be serviced.
PFD1 DB ERR – PFD1 terrain database error exists.	The PFD detected a fault in the terrain database. Ensure that the terrain card is properly inserted in display. Replace terrain card. If problem persists, the system should be serviced.
PFD1 DB ERR – PFD1 terrain database missing.	The terrain database is present on another LRU, but is missing on the specified LRU.
PFD1 DB ERR – PFD1 obstacle database error exists.	The PFD detected a fault in the obstacle database. Ensure that the data card is properly inserted. Replace data card. If problem persists, the system should be serviced.
PFD1 DB ERR – PFD1 obstacle database missing.	The obstacle database is present on another LRU, but is missing on the specified LRU.

Message	Comments
PFD1 DB ERR – PFD1 Safe Taxi database error exists.	The MFD and/or PFD detected a fault in the Safe Taxi database. Ensure that the data card is properly inserted. Replace data card. If problem persists, the system should be serviced.
PFD1 DB ERR – PFD1 multiple database errors exists.	The PFD detected a fault in more than one database. If problem persists, the system should be serviced.
PFD1 SERVICE – PFD1 needs service. Return unit for repair.	The PFD self-test has detected a problem. The system should be serviced.
PFD1 CONFIG – PFD1 configuration error. Config service req'd.	The PFD configuration settings do not match backup configuration memory. The system should be serviced.
PFD1 COOLING – PFD1 has poor cooling. Reducing power usage.	The PFD is overheating and is reducing power consumption by dimming the display. If problem persists, the system should be serviced.
PFD1 KEYSTK – PFD1 [keyname] Key is stuck.	A key is stuck on the PFD and/or MFD bezel. Attempt to free the stuck key by pressing it several times. The system should be serviced if the problem persists.
MFD1 KEYSTK – MFD [keyname] Key is stuck.	
PFD1 VOLTAGE – PFD1 has low voltage. Reducing power usage.	The PFD1 voltage is low. The system should be serviced.
[PFD1, or MFD1] CARD 1 REM – Card 1 was removed. Reinsert card.	The SD card was removed from the top card slot of the PFD or MFD. The SD card needs to be reinserted.
[PFD1, or MFD1] CARD 2 REM – Card 2 was removed. Reinsert card.	The SD card was removed from the bottom card slot of the PFD or MFD. The SD card needs to be reinserted.
[PFD1, or MFD1] CARD 1 ERR – Card 1 is invalid.	The SD card in the top card slot of the PFD or MFD contains invalid data.
[PFD1, or MFD1] CARD 2 ERR – Card 2 is invalid.	The SD card in the bottom card slot of the specified PFD or MFD contains invalid data.
PTK FAIL – Parallel track unavailable: bad geometry.	Bad parallel track geometry.
PTK FAIL – Parallel track unavailable: invalid leg type.	Invalid leg type for parallel offset.
PTK FAIL – Parallel track unavailable: past IAF.	IAF waypoint for parallel offset has been passed.
REGISTER CONNEXT – Data services are inoperative, register w/Connex.	The GDL 59 is not registered with Garmin Connex or its current registration data has failed authentication.
SCHEDULER [#] – <message>.	Message criteria entered by the user.
SLCT FREQ – Select appropriate frequency for approach.	The system notifies the pilot to load the approach frequency for the appropriate NAV receiver. Select the correct frequency for the approach.
SLCT NAV – Select NAV on CDI for approach.	The system notifies the pilot to set the CDI to the correct NAV receiver. Set the CDI to the correct NAV receiver.
STEEP TURN – Steep turn ahead.	A steep turn is 15 seconds ahead. Prepare to turn.
STRMSCP FAIL – Stormscope has failed.	Stormscope has failed. The system should be serviced.
SVT DISABLED - Out of available terrain region.	Synthetic Vision is disabled because the aircraft is not within the boundaries of the installed terrain database.
SVT DISABLED – Terrain DB resolution too low.	Synthetic Vision is disabled because a terrain database of sufficient resolution (9 arc-second or better) is not currently installed.

SYSTEM OVERVIEW

FLIGHT INSTRUMENTS

EIS

AUDIO PANEL & CNS

FLIGHT MANAGEMENT

HAZARD AVOIDANCE

AFCS

ADDITIONAL FEATURES

APPENDICES

INDEX

Message	Comments
SW MISMATCH – GDU software version mismatch. Xtalk is off.	The MFD and PFD have different software versions installed. The system should be serviced.
TERRAIN AUD CFG – Trn Awareness audio config error. Service req'd.	Terrain audio alerts are not configured properly. The system should be serviced
TERRAIN DSP – [PFD1 or MFD1] Terrain awareness display unavailable.	One of the terrain, airport terrain, or obstacle databases required for TAWS in the PFD or MFD is missing or invalid.
TIMER EXPIRD – Timer has expired.	The system notifies the pilot that the timer has expired.
TRAFFIC FAIL – Traffic device has failed.	The system is no longer receiving data from the traffic system. The traffic device should be serviced.
TRN AUD FAIL – Trn Awareness audio source unavailable.	The audio source for terrain awareness is offline. Check GIA1 or GIA 2.
UNABLE V WPT – Can't reach current vertical waypoint.	The current vertical waypoint can not be reached within the maximum flight path angle and vertical speed constraints. The system automatically transitions to the next vertical waypoint.
VNV – Unavailable. Unsupported leg type in flight plan.	The lateral flight plan contains a procedure turn, vector, or other unsupported leg type prior to the active vertical waypoint. This prevents vertical guidance to the active vertical waypoint.
VNV – Unavailable. Excessive crosstrack error.	The current crosstrack exceeds the limit, causing vertical deviation to go invalid.
VNV – Unavailable. Excessive track angle error.	The current track angle error exceeds the limit, causing the vertical deviation to go invalid.
VNV – Unavailable. Parallel course selected.	A parallel course has been selected, causing the vertical deviation to go invalid.
WPT ARRIVAL – Arriving at waypoint -[xxxx]	Arriving at waypoint [xxxx], where [xxxx] is the waypoint name.
XPDR1 ADS-B FAIL – XPDR1 unable to transmit ADS-B messages.	ADS-B is inoperative. Other transponder functions may be available. Transponder should be serviced when possible. (GTX 33 with Extended Squitter only.)
XPDR1 CONFIG – XPDR1 config error. Config service req'd.	The transponder configuration settings do not match those of backup configuration memory or the Mode S address is invalid. The Perspective system should be serviced.
XPDR1 FAIL – XPDR1 is inoperative.	There is no communication with the #1 transponder.
XPDR1 SRVC – XPDR1 needs service. Return unit for repair.	The #1 transponder should be serviced when possible.
XTALK ERROR – A flight display crosstalk error has occurred.	The MFD and PFD are not communicating with each other. The system should be serviced.

ADS-B STATUS PAGE MESSAGES

ADS-B Status Page Item	Status Message	
Traffic Application Status: AIRBORNE (AIRB), SURFACE (SURF), AIRBORNE ALERTS (CSA)	ON	Traffic application is currently on. Required input data is available, and it meets performance requirements.
	AVAILABLE TO RUN	Traffic application is not currently active, but application is ready to run when condition(s) determine the application should be active. Required input data is available, and it meets performance requirements.
	NOT AVAILABLE	Traffic application is not available. Required input data is available, but it does not meet performance requirements.
	FAULT	Traffic application is not available. Required input data is not available or the application has failed.
	NOT CONFIGURED	Traffic application is not available, because it has not been configured. If this annunciation persists, the system should be serviced.
	-----	Traffic application status is invalid or unknown.
TIS-B/ADS-R Coverage	AVAILABLE	The system is receiving the ADS-R coverage from an FAA ground station.
	NOT AVAILABLE	The system is not receiving the ADS-R coverage from an FAA ground station.
	-----	ADS-R coverage is invalid or unknown.
GPS Status: GPS Source	External #1	The GDL 88 is using the #1 GPS receiver for the GPS position source.
	External #2	The GDL 88 is using the #2 GPS receiver for the GPS position source.
	-----	The GPS source is invalid or unknown.
Ground Uplink Status: Last uplink	Number of minutes, or '-----'	Displays the number of minutes since the last uplink from a ground station occurred. If no uplink has been received, or the status is invalid, dashes appear instead of a number of minutes.
FIS-B Weather Status: FIS-B Processing	ENABLED	The FIS-B weather feature is enabled to process and display FIS-B weather products.
	DISABLED	The FIS-B weather feature is disabled.
	-----	No data received from the GDL 88 UAT.
Weather Products: AIRMET CONUS NEXRAD METAR METAR GRAPHICAL NOTAM/TFR PIREP REGIONAL NEXRAD SIGMET TAF WINDS/TEMPS ALOFT	AVAILABLE	FIS-B weather data is available for display for the weather product.
	NOT AVAILABLE	FIS-B weather data is not available for the weather product, and/or the system is not receiving the FIS-B weather service.
	AWAITING DATA	The system is receiving the FIS-B weather service, and is waiting to receive the weather product from the FIS-B data broadcast.

AFCS STATUS ALERTS

The annunciations in Table A-10 (listed in order of increasing priority) can appear on the PFD above the Airspeed and Attitude indicators. Only one annunciation may occur at a time, and messages are prioritized by criticality.

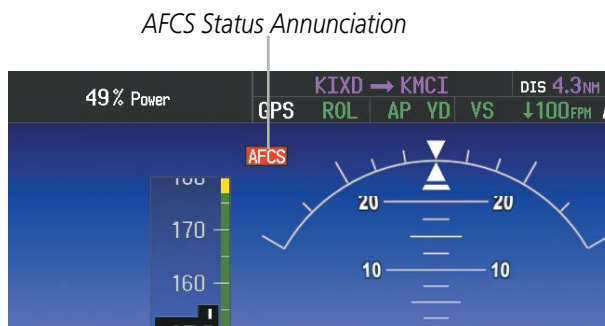

Figure A-7 AFCS Status Annunciation

Alert Condition	Annunciation	Description
Rudder Mistrim Right	RUD→	Yaw servo providing sustained force in the indicated direction
Rudder Mistrim Left	←RUD	
Aileron Mistrim Right	AIL→	Roll servo providing sustained force in the indicated direction
Aileron Mistrim Left	←AIL	
Elevator Mistrim Down	↓ELE	Pitch servo providing sustained force in the indicated direction
Elevator Mistrim Up	↑ELE	
Pitch Trim Failure	PTRM	If AP engaged, take control of the aircraft and disengage AP If AP disengaged, move MET switch to unstick
Yaw Damper Failure	YAW	YD control failure
Roll Failure	ROLL	Roll axis control failure; AP inoperative
Pitch Failure	PTCH	Pitch axis control failure
System Failure	AFCS	AP and MET are unavailable; FD may still be available
Preflight Test	PFT	Performing preflight system test. Do not press the AP DISC Button during servo power-up and preflight system tests as this may cause the preflight system test to fail or never to start (if servos fail their power-up tests). Power must be cycled to the servos to remedy the situation.
	PFT	Preflight system test failed; aural alert sounds at failure
Hypoxia Recognition System is activated	EDM	Activated only by the Hypoxia Recognition System

Table A-10 AFCS Status Alerts

GARMIN AFCS CONDITION/STALL ALERT

The following annunciations can appear on the PFD directly above the Airspeed indicator.

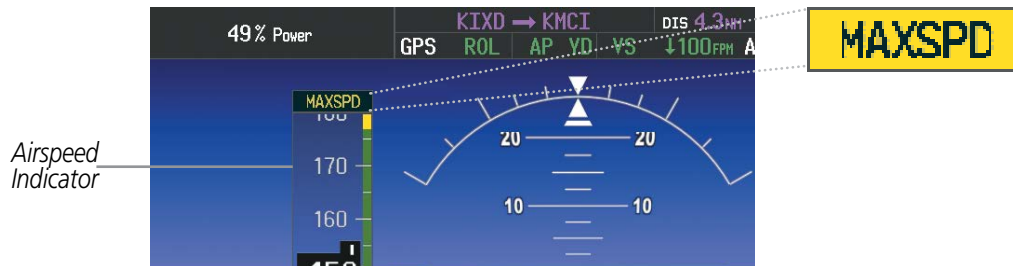

Figure A-8 Overspeed Annunciation

Condition	Annunciation	Description
Overspeed	MAXSPD	Flashing annunciation indicating aircraft overspeed condition. The autopilot, if engaged, will follow the pitch up command for the flight director. Engine power should be reduced and/or the pitch reference adjusted to slow the aircraft. The annunciation disappears when the overspeed condition is resolved.
Underspeed/Stall	MINSPD	Flashing annunciation indicating aircraft underspeed or imminent stall condition. An underspeed condition initiates flight director commands for pitch down and, if engaged, the autopilot will follow the pitch down command. Engine power should be increased and/or the pitch reference adjusted to increase airspeed. A stall condition causes the flight director to capture the Stall Warning Reference Airspeed (i.e., the speed at which Stall Warning Mode was entered) and commands a pitch attitude to follow the reference speed. The Stall Warning Reference Airspeed is increased at a rate of one kt/sec. The annunciation disappears when the condition is resolved.

Table A-11 AFCS Condition / Stall Alerts

TERRAIN-SVS ALERTS

Annunciations appear on the PFD and MFD. Pop-up alerts appear only on the MFD. For more information on Terrain-SVS, refer to the Hazard Avoidance Section.

Alert Type	PFD/MFD* Alert Annunciation	MFD Pop-Up Alert (except Terrain-SVS Page)	Voice Alert
Reduced Required Terrain Clearance Warning (RTC)	TERRAIN	WARNING - TERRAIN	"Warning; Terrain, Terrain"
Imminent Terrain Impact Warning (ITI)	TERRAIN	WARNING - TERRAIN	"Warning; Terrain, Terrain"
Reduced Required Obstacle Clearance Warning (ROC)	TERRAIN	WARNING - OBSTACLE	"Warning; Obstacle, Obstacle"
Imminent Obstacle Impact Warning (IOI)	TERRAIN	WARNING - OBSTACLE	"Warning; Obstacle, Obstacle"
Reduced Required Terrain Clearance Caution (RTC)	TERRAIN	CAUTION - TERRAIN	"Caution; Terrain, Terrain"

Alert Type	PFD/MFD* Alert Annunciation	MFD Pop-Up Alert (except Terrain-SVS Page)	Voice Alert
Imminent Terrain Impact Caution (ITI)	TERRAIN	CAUTION - TERRAIN	"Caution; Terrain, Terrain"
Reduced Required Obstacle Clearance Caution (ROC)	TERRAIN	CAUTION - OBSTACLE	"Caution; Obstacle, Obstacle"
Imminent Obstacle Impact Caution (IOI)	TERRAIN	CAUTION - OBSTACLE	"Caution; Obstacle, Obstacle"

* Annunciation is displayed on the MFD when terrain display is enabled.

Table A-12 Terrain-SVS Alerts Summary

TERRAIN-SVS SYSTEM STATUS ANNUNCIATIONS

Alert Type	PFD/MFD TERRAIN-SVS Page Annunciation	TERRAIN-SVS Page Center Banner Annunciation	Voice Alert
System Test in Progress	TER TEST	TERRAIN TEST	None
System Test Pass	None	None	Single Chime
Terrain Alerting is disabled	TER INH	None	None
MFD Terrain or Obstacle database unavailable or invalid. Terrain-SVS operating with PFD Terrain or Obstacle databases	None	TERRAIN DATABASE FAILURE	None
Terrain System Test Fail	TER FAIL	TERRAIN FAIL	"Terrain System Failure"
Terrain or Obstacle database unavailable or invalid, invalid software configuration, system audio fault	TER FAIL	TERRAIN FAIL	"Terrain System Failure"
No GPS position	TER N/A	NO GPS POSITION	"Terrain System Not Available"
Excessively degraded GPS signal, Out of database coverage area	TER N/A	None	"Terrain System Not Available"
Sufficient GPS signal reception restored	None	None	"Terrain System Available"

Table A-13 Terrain-SVS System Status Annunciations

TAWS-B ALERTS

Annunciations appear on the PFD and MFD. Pop-up alerts appear only on the MFD when the TAWS-B page is not in view. For more information on TAWS-B, refer to the Hazard Avoidance Section.

Alert Type	PFD/MFD** Alert Annunciation	MFD Pop-Up Alert (except TAWS-B Page)	Voice Alert
Excessive Descent Rate Warning (EDR)	PULL UP	PULL-UP	"Pull Up"
Reduced Required Terrain Clearance Warning (RTC)	PULL UP	TERRAIN - PULL-UP* or TERRAIN AHEAD - PULL-UP	"Terrain, Terrain; Pull Up, Pull Up"* or "Terrain Ahead, Pull Up; Terrain Ahead, Pull Up"

Alert Type	PFD/MFD** Alert Annunciation	MFD Pop-Up Alert (except TAWS-B Page)	Voice Alert
Imminent Terrain Impact Warning (ITI)	PULL UP	TERRAIN - PULL-UP or TERRAIN AHEAD - PULL-UP *	"Terrain, Terrain; Pull Up, Pull Up" or "Terrain Ahead, Pull Up; Terrain Ahead, Pull Up" *
Reduced Required Obstacle Clearance Warning (ROC)	PULL UP	OBSTACLE - PULL-UP * or OBSTACLE AHEAD - PULL-UP	"Obstacle, Obstacle; Pull Up, Pull Up" * or "Obstacle Ahead, Pull Up; Obstacle Ahead, Pull Up"
Imminent Obstacle Impact Warning (IOI)	PULL UP	OBSTACLE - PULL-UP or OBSTACLE AHEAD - PULL-UP *	"Obstacle, Obstacle; Pull Up, Pull Up" or "Obstacle Ahead, Pull Up; Obstacle Ahead, Pull Up" *
Reduced Required Terrain Clearance Caution (RTC)	TERRAIN	CAUTION - TERRAIN * or TERRAIN AHEAD	"Caution, Terrain; Caution, Terrain" * or "Terrain Ahead; Terrain Ahead"
Imminent Terrain Impact Caution (ITI)	TERRAIN	CAUTION - TERRAIN or TERRAIN AHEAD *	"Caution, Terrain; Caution, Terrain" or "Terrain Ahead; Terrain Ahead" *
Reduced Required Obstacle Clearance Caution (ROC)	TERRAIN	CAUTION - OBSTACLE * or OBSTACLE AHEAD	"Caution, Obstacle; Caution, Obstacle" * or "Obstacle Ahead; Obstacle Ahead"
Imminent Obstacle Impact Caution (IOI)	TERRAIN	CAUTION - OBSTACLE or OBSTACLE AHEAD *	"Caution, Obstacle; Caution, Obstacle" or "Obstacle Ahead; Obstacle Ahead" *
Premature Descent Alert Caution (PDA)	TERRAIN	TOO LOW - TERRAIN	"Too Low, Terrain"
Altitude Callout (VCO) "500"	None	None	"Five-Hundred"
Excessive Descent Rate Caution (EDR)	TERRAIN	SINK RATE	"Sink Rate"
Negative Climb Rate Caution (NCR)	TERRAIN	DON'T SINK * or TOO LOW - TERRAIN	"Don't Sink" * or "Too Low, Terrain"

* Alerts with multiple messages are configurable at installation and are installation-dependent. Alerts for the default configuration when more than one option is available are indicated with asterisks.

** Annunciation is displayed on the MFD when terrain display is enabled.

Table A-14 TAWS-B Alerts Summary

TAWS-B SYSTEM STATUS ANNUNCIATIONS

Alert Cause	PFD/MFD Annunciation	TAWS-B Page Annunciation	Voice Alert
MFD Terrain or Obstacle database unavailable or invalid. TAWS operating with PFD Terrain or Obstacle databases	None	TERRAIN DATABASE FAILURE	None
Terrain or Obstacle database unavailable or invalid on all displays, invalid software configuration, TAWS audio fault	TAWS FAIL	TAWS FAIL	"TAWS System Failure"
No GPS position	TAWS N/A	NO GPS POSITION	"TAWS Not Available" "TAWS Available" when GPS position returns.
Excessively degraded GPS signal	TAWS N/A	None	"TAWS Not Available" "TAWS Available" when sufficient GPS signal is received.
Out of database coverage area	TAWS N/A	None	"TAWS Not Available" "TAWS Available" when aircraft enters database coverage area.

Table A-15 TAWS-B System Status Annunciations

FLIGHT PLAN IMPORT/EXPORT MESSAGES

In some circumstances, some messages may appear in conjunction with others.

Flight Plan Import/Export Results	Description
'Flight plan successfully imported.'	A flight plan file stored on the SD card was successfully imported as a stored flight plan.
'File contained user waypoints only. User waypoints imported successfully. No stored flight plan data was modified.'	The file stored on the SD card did not contain a flight plan, only user waypoints. These waypoints have been saved to the system user waypoints. No flight plans stored in the system have been modified.
'No flight plan files found to import.'	The SD card contains no flight plan data.
'Flight plan import failed.'	Flight plan data was not successfully imported from the SD card.
'Flight plan partially imported.'	Some flight plan waypoints were successfully imported from the SD card, however others had errors and were not imported. A partial stored flight plan now exists in the system.
'File contained user waypoints only.'	The file stored on the SD card did not contain a flight plan, only user waypoints. One or more of these waypoints did not import successfully.
'Too many points. Flight plan truncated.'	The flight plan on the SD card contains more waypoints than the system can support. The flight plan was imported with as many waypoints as possible.
'Some waypoints not loaded. Waypoints locked.'	The flight plan on the SD card contains one or more waypoints that the system cannot find in the navigation database. The flight plan has been imported, but must be edited within the system before it can be activated for use.

Flight Plan Import/Export Results	Description
'User waypoint database full. Not all loaded.'	The flight plan file on the SD card contains user waypoints. The quantity of stored user waypoints has exceeded system capacity, therefore not all the user waypoints on the SD card have been imported. Any flight plan user waypoints that were not imported are locked in the flight plan. The flight plan must be edited within the system before it can be activated for use.
'One or more user waypoints renamed.'	One or more imported user waypoints were renamed when imported due to naming conflicts with waypoints already existing in the system.
'Flight plan successfully exported.'	The stored flight plan was successfully exported to the SD card.
'Flight plan export failed.'	The stored flight plan was not successfully exported to the SD card. The SD card may not have sufficient available memory or the card may have been removed prematurely.

Table A-16 Flight Plan Import / Export Messages

PILOT PROFILE IMPORT/EXPORT MESSAGES

Pilot Profile Import/Export Results	Description
'Pilot profile import succeeded.'	The pilot profile has been successfully imported from the SD card into the system.
'Pilot profile import failed.'	The pilot profile was not successfully imported from the SD card into the system.
'Pilot profile export succeeded.'	The pilot profile has been successfully exported from the system to the SD card.
'Pilot profile export failed.'	The pilot profile was not successfully exported from the system to the SD card. The SD card may not have sufficient available memory or the card may have been removed prematurely.
'No pilot profiles found to import.'	The SD card does not contain pilot profile data or an SD card has not been inserted.
'Profile name invalid. Enter a different profile name.'	The pilot profile names "DEFAULT PROFILE", "CURRENT SETTINGS", "GARMIN DEFAULTS", "NONE", or a name beginning with a blank space are reserved by the system and cannot be used. Choose a different pilot profile name.
'All available pilot profiles in use. Delete a profile before importing another.'	The maximum quantity of pilot profiles which can be stored on the system has been reached. Delete a profile on the system before importing another profile from an SD card.

Table A-17 Pilot Profile Import / Export Messages

TAS SYSTEM ANNUNCIATIONS





Traffic Mode	Traffic Mode Annunciation (Traffic Map Page)	Traffic Display Status Icon (Other Maps)
TAS System Test Initiated	TEST (also shown in white in center of page)	
TAS Operating	OPERATING	
TAS Standby	STANDBY (also shown in white in center of page)	
TAS Failed	FAIL	

Table A-18 TAS Modes

Traffic Status Banner Annunciation	Description
TA OFF SCALE	A Traffic Advisory is outside the selected display range*. Annunciation is removed when traffic comes within the selected display range.
TA X.X ± XX ↓	System cannot determine bearing of Traffic Advisory**. Annunciation indicates distance in nm, altitude separation in hundreds of feet, and altitude trend arrow (climbing/descending).
TRFC FAIL	TAS unit has failed (unit is self-reporting a failure or sending incorrectly formatted data)
NO TRFC DATA	Data is not being received from the TAS unit

*Shown as symbol on Traffic Map Page
 **Shown in center of Traffic Map Page

Table A-19 TAS Traffic Status Annunciations

Traffic Map Page Center Annunciation	Description
NO DATA	Data is not being received from the traffic unit
DATA FAILED	Data is being received from the traffic unit, but the unit is self-reporting a failure
FAILED	Incorrect data format received from the traffic unit

Table A-20 Traffic Failure Annunciations

ADS-B TRAFFIC ANNUNCIATIONS

Mode	Traffic Mode Annunciation (Traffic Map Page)	Traffic Map Page Center Banner Annunciation	Traffic Display Status Icon (Other Maps)
ADS-B System Test Initiated	ADS-B: TEST	TEST MODE	
ADS-B Operating in Airborne Mode	ADS-B: AIRB	ADS-B: AIRB	
ADS-B Operating in Surface Mode	ADS-B: SURF	ADS-B: SURF	
ADS-B Traffic Off	ADS-B: OFF	ADS-B TRFC OFF	
ADS-B Traffic Not Available	ADS-B: N/A	ADS-B TRFC N/A	
ADS-B Failed	ADS-B: FAIL	ADS-B TRFC FAIL	

Table A-21 Mode Annunciations

Traffic Status Banner Annunciation	Description
TA OFF SCALE	A Traffic Advisory is outside the selected display range*. Annunciation is removed when traffic comes within the selected display range.
TA X.X ± XX ↓	System cannot determine bearing of Traffic Advisory**. Annunciation indicates distance in nm, altitude separation in hundreds of feet, and altitude trend arrow (climbing/descending).
TRFC FAIL	Traffic unit has failed (unit is self-reporting a failure or sending incorrectly formatted data)
NO TRFC DATA	Data is not being received from the traffic unit

*Shown as symbol on Traffic Map Page

**Shown in center of Traffic Map Page

Table A-22 Traffic Status Annunciations

Traffic Map Page Center Annunciation	Description
NO DATA	Data is not being received from the traffic unit
DATA FAILED	Data is being received from the traffic unit, but the unit is self-reporting a failure
ADS-B TRFC FAIL	Incorrect data format received from the traffic unit

Table A-23 Traffic Failure Annunciations

CONNEXT WEATHER MESSAGES

Weather Request Status Message	Description
Auto requests inhibited Send manual request to reset.	The system has disabled automatic weather data requests due to excessive errors. Automatic weather data requests have stopped. Send a manual weather data request to resume automatic updates.
Auto update retry: ## Seconds	The system will attempt another automatic weather data request after an error occurred during the previous request. Timer counts down until the next automatic request occurs.
Connext Comm Error [2]	A communications error has occurred with the GIA or optional GDL 59. The system should be serviced.
Connext Comm Error [4]	This occurs if multiple automatic weather data requests have recently failed, or the GIA or optional GDL 59 is off-line.
Connext Comm Error [5]	The Iridium or Connext networks are not accessible, or the GDL 59 is off-line or not configured. Check Iridium signal strength. If this error persists, the system should be serviced.
Connext Comm Error [6]	A communications error has occurred. If this error persists, the system should be serviced.
Connext Comm Error [7]	A weather data transfer has timed out. Check Iridium signal strength and re-send the data request.
Connext Comm Error [8]	A server error has occurred or invalid data received.
Connext Login Invalid	There is a problem with the Garmin Connext registration. Please visit www.flygarmin.com for assistance.
Connext Server Temporarily Inop	The Garmin Connext weather data server is temporarily out of service, but is expected to return to service in less than 30 minutes.
Connext Server Inop	The Garmin Connext weather data server will be out of service for at least 30 minutes.
Invalid Coverage Area	The weather data request coverage area does not contain at least one of the following: a waypoint, a flight plan, or a flight plan destination. Verify at least one of the coverage options is enabled (checked) and contains required criteria, then re-send the data request.
No Connext Subscription	The system is not currently subscribed to the Garmin Connext Weather service, or the access code is incorrect. Verify the access code. Please visit www.flygarmin.com for assistance.
Reduce Request Area	The Garmin Connext weather data request area exceeds size limits. Reduce weather coverage area and re-send data request.
Request Cancelled	The user has cancelled a Garmin Connext weather data request.
Request Failed - Try Again	The weather data request timed-out. Re-send data request.
Transfer Preempted	The optional GDL 59 is busy. Retry request later.

Table A-24 Abnormal Garmin Connext Weather Request Status Messages

DATABASE MANAGEMENT

Database information is obtained from third party sources. Inaccuracies in the data may be discovered from time to time. Garmin communicates this information by issuing a Database Alert. These notifications are available on <http://fly.garmin.com>.

Garmin requests the flight crew report any observed discrepancies related to database information. These discrepancies could come in the form of an incorrect procedure; incorrectly identified terrain, obstacles and fixes; or any other displayed item used for navigation or communication in the air or on the ground. Go to <http://fly.garmin.com> and select “Aviation Data Error Report”.



CAUTION: Never disconnect power to the system when loading a database. Power interruption during the database loading process could result in maintenance being required to reboot the system.

The system uses Secure Digital (SD) cards to load and store various types of data. For basic flight operations, SD cards are required for database storage as well as Jeppesen navigation and ChartView database updates. Not all SD cards are compatible with the Prodigy® system. Use only SD cards supplied by Garmin or the aircraft manufacturer.



CAUTION: When downloading updates to the Jeppesen Navigation Database, copy the data to an SD card other than a Garmin Supplemental Data Card. Otherwise, data corruption can occur.



NOTE: When loading database updates, the ‘DB Mismatch’ message will be displayed until database synchronization is complete, followed by turning system power off, then on. Synchronization can be monitored on the AUX-SYSTEM STATUS Page.



NOTE: Loading a database in the system prior to its effective date will result in the expiration date on the Power-Up Page and the effective date on the AUX-System Status Page being displayed in amber.

JEPPESEN DATABASES

The Jeppesen navigation database is updated on a 28-day cycle. The ChartView database is updated on a 14-day cycle. If the ChartView database is not updated within 70 days of the expiration date, ChartView will no longer function. Both of these databases are provided directly from Jeppesen.

The ChartView database should be copied to the Garmin supplied Supplemental Data Card which will reside in the bottom card slot on the MFD. The navigation database must be installed from the Jeppesen or user supplied SD data card. Contact Jeppesen (www.jeppesen.com) for subscription and update information.



NOTE: After the navigation database is installed, the card may be removed.

Updating the active Jeppesen navigation database (not using the Dual Navigation Database or Automatic Database Synchronization Features):

- 1) With the system OFF, insert the SD card containing the new navigation database version into the top card slot of the display (PFD1 or MFD) to be updated (label of SD card facing left).
- 2) Apply power to the system. A prompt similar to the following appears in the upper left corner of the display:

```

DO YOU WANT TO UPDATE THE STANDBY NAVIGATION DATABASE ON THE BOTTOM CARD?
THE STANDBY DATABASE WILL BE ACTIVATED UPON THE FIRST ON-GROUND POWER CYCLE ON OR
AFTER 00:00 SYSTEM TIME ON THE EFFECTIVE DATE.
FROM TO
REGION: WORLDWIDE WORLDWIDE
CYCLE: 1812 1813
EFFECTIVE: 08-NOV-2018 06-DEC-2018
EXPIRES: 06-DEC-2018 03-JAN-2018

NO WILL BE ASSUMED IN 21 SECONDS.

```

Figure B-1 Standby Navigation Database Prompt

- 3) Press the **NO** Softkey to proceed to loading the active database.
- 4) A prompt similar to the following is displayed; press the **YES** Softkey to update the active navigation database.

```

DO YOU WANT TO UPDATE THE ACTIVE NAVIGATION DATABASE?
SELECTING YES WILL OVERWRITE THE ACTIVE NAVIGATION DATABASE.
FROM TO
REGION: WORLDWIDE WORLDWIDE
CYCLE: 1812 1813
EFFECTIVE: 08-NOV-2018 06-DEC-2018
EXPIRES: 06-DEC-2018 03-JAN-2018

NO WILL BE ASSUMED IN 8 SECONDS.
UPDATING THE ACTIVE NAVIGATION DATABASE, PLEASE WAIT.
.
UPDATED 1 FILES SUCCESSFULLY!
PRESS ANY KEY TO CONTINUE.
CONTINUING IN 8 SECONDS.

```

Figure B-2 Database Update Confirmation

- 5) After the update completes, the display starts in normal mode. Do not remove power while the display is starting.
- 6) Turn the system OFF and remove the SD card from the top card slot.
- 7) Repeat steps 1 through 6 for the other display (PFD1 or MFD). Remove the SD card when finished.
- 8) Apply power to the system and press the **ENT** Key to acknowledge the Power-Up Page.
- 9) Turn the large **FMS** Knob to select the AUX Page group on the MFD.
- 10) Turn the small **FMS** Knob to select the System Status Page.
- 11) Press the Display Database Selection Softkey to show active navigation database information for each display (**MFD1 DB, PFD1 DB**). Verify the correct active navigation database cycle information is shown for each display.

DUAL NAVIGATION DATABASE FEATURE

The dual navigation database feature allows each display to store an upcoming navigation database on the bottom SD card so that the system can automatically load it to replace the active database when the new database becomes effective (the next cycle becomes available seven days prior to its effective date), or when the pilot chooses to manually activate the standby navigation database on the AUX System Status Page.

If a navigation database loader card is inserted into the top SD card slot of a display, and an SD card is in the bottom slot, the system will prompt the user (upon on-ground power up) as to whether the database should be stored on the bottom SD card as the standby database. If the user responds affirmatively, the system will copy the navigation database from the top SD card to the bottom SD card. As long as the bottom SD card remains in the card slot, this standby navigation database will be available for the system to use as the active database as soon as it becomes effective or if the pilot chooses to manually activate the database.

The system checks the active and standby databases upon (on-ground only) power-up. If the standby database is current and the active database is out of date, the display will upload the standby database into the active internal database location. Loading the standby database to the active location takes approximately 45-55 seconds. During the loading process 'Please Wait. Navigation Database Update in Progress. Do Not Remove Power from Displays' will be displayed on screen. After startup is complete, the pilot is alerted that the update is complete by a system alert message, 'NAV DB UPDATED'.

Loading a standby navigation database:

- 1) With the system OFF, insert the SD card containing the new navigation database version into the top card slot of the MFD.
- 2) Verify that an SD card is inserted in the bottom slot of the PFD.
- 3) Apply power to the system. A prompt similar to the following is displayed.

```
DO YOU WANT TO UPDATE THE STANDBY NAVIGATION DATABASE ON THE BOTTOM CARD?
THE STANDBY DATABASE WILL BE ACTIVATED UPON THE FIRST ON-GROUND POWER CYCLE ON OR
AFTER 00:00 SYSTEM TIME ON THE EFFECTIVE DATE.
FROM TO
REGION: WORLDWIDE WORLDWIDE
CYCLE: 1812 1813
EFFECTIVE: 08-NOV-2018 06-DEC-2018
EXPIRES: 06-DEC-2018 03-JAN-2018
NO WILL BE ASSUMED IN 21 SECONDS.
```

Figure B-3 Standby Navigation Database Prompt

- 4) Press the **YES** Softkey. The navigation database is copied to the SD card in the bottom card slot of the MFD.
- 5) After the navigation database files are copied to the bottom SD card, the display will appear as shown in Figure B-4.

```
INITIALIZING SYSTEM
DO YOU WANT TO UPDATE THE STANDBY NAVIGATION DATABASE ON THE BOTTOM CARD?
THE STANDBY DATABASE WILL BE ACTIVATED UPON THE FIRST ON-GROUND POWER CYCLE ON OR
AFTER 00:00 SYSTEM TIME ON THE EFFECTIVE DATE.
FROM TO
REGION: WORLDWIDE WORLDWIDE
CYCLE: 1812 1813
EFFECTIVE: 08-NOV-2018 06-DEC-2018
EXPIRES: 06-DEC-2018 03-JAN-2018
NO WILL BE ASSUMED IN 18 SECONDS.
UPDATING STANDBY NAVIGATION DATABASE, PLEASE WAIT.
.
UPDATED STANDBY NAVIGATION DATABASE SUCCESSFULLY.
PRESS ANY KEY TO CONTINUE.
CONTINUING IN 9 SECONDS.
```

Figure B-4 Standby Navigation Database Update Complete

- 6) As instructed on the display, press any key to continue. The display will now appear as shown in Figure B-5.

```

DATABASE NAVIGATION WILL BE VERIFIED BEFORE USE.
DATABASE STANDBY NAV WILL BE VERIFIED BEFORE USE.
PRESS ANY KEY TO CONTINUE.
CONTINUING IN 6 SECONDS.

```

Figure B-5 Navigation Database Verification Prompt

- 7) Press any key to continue. The display will now appear as shown in Figure B-6.

```

DO YOU WANT TO UPDATE THE ACTIVE NAVIGATION DATABASE?
SELECTING YES WILL OVERWRITE THE ACTIVE NAVIGATION DATABASE.
FROM TO
REGION: WORLDWIDE WORLDWIDE
CYCLE: 1812 1813
EFFECTIVE: 08-NOV-2018 06-DEC-2018
EXPIRES: 06-DEC-2018 03-JAN-2018
NO WILL BE ASSUMED IN 8 SECONDS.

```

Figure B-6 Active Navigation Database Prompt

- 8) Press the **NO** Softkey. The display now starts in normal mode. Since the database effective date is not yet valid, it should not be loaded as the active database. The display now starts in normal mode. Do not remove power while the display is starting.
- 9) Press the **ENT** Key to acknowledge the Power-Up Page.
- 10) Turn the large **FMS** Knob to select the AUX Page group on the MFD.
- 11) Turn the small **FMS** Knob to select the System Status Page.
- 12) The new database is copied to the SD card in the bottom card slot of the PFD. Progress can be monitored in the SYNC STATUS field. When copying is finished, 'Complete' is displayed.
- 13) Remove power from the system.
- 14) Remove the SD card from the top card slot of the MFD.
- 15) Apply power to the system.
- 16) Press the **ENT** Key to acknowledge the Power-Up Page.
- 17) Turn the large **FMS** Knob to select the AUX Page group on the MFD.
- 18) Turn the small **FMS** Knob to select the System Status Page.
- 19) Press the Display Database Selection Softkey to show standby navigation database information for each display (**MFD1 DB, PFD1 DB**). Verify the correct standby navigation database cycle information is shown for each display.

Manually activating the standby navigation database:

- 1) From the AUX-SYSTEM STATUS Page, select the **STANDBY DB** Softkey.
- 2) A prompt similar to the following figure below is displayed, select 'Yes' to overwrite the Active Navigation Database with the Standby Navigation Database. Select 'No' to cancel.

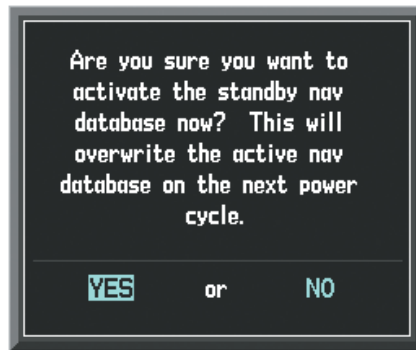

Figure B-7 Standby Nav Database Activation Confirmation Window

- 3) Remove power from the system.
- 4) Apply power to the system.
- 5) Press the **ENT** Key to acknowledge the Power-Up Page.
- 6) Turn the large **FMS** Knob to select the AUX Page group on the MFD.
- 7) Turn the small **FMS** Knob to select the System Status Page.
- 8) Select the Display Database Selection Softkey to show navigation database information for each display (**MFD1 DB, PFD1 DB**). Verify the correct navigation database cycle information is shown for each display.

GARMIN DATABASES

The following databases are stored on Supplemental Data Cards provided by Garmin:

- Expanded basemap
- Terrain
- Obstacle
- SafeTaxi
- FliteCharts
- Airport Directory (AOPA or AC-U-KWIK)

After subscribing to the desired database product, these database products will be downloaded and ultimately stored on three Supplemental Data Cards (with the exception of FliteCharts, which is loaded on only one card). Each Supplemental Data Card is installed in the bottom card slot of each display as shown in Figure B-8. These cards must not be removed except to update the databases stored on each card.

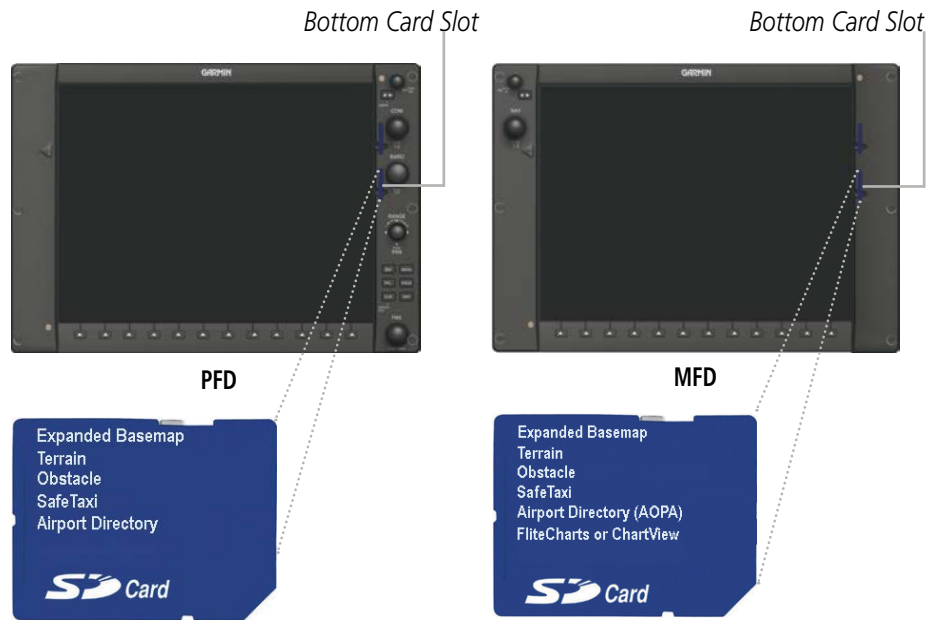

Figure B-8 Correct Database Locations

Since these databases are not stored internally in the displays, a Supplemental Data Card containing identical database versions must be kept in each display unit.

The basemap database contains data for the topography and land features, such as rivers, lakes, and towns. It is updated only periodically, with no set schedule. There is no expiration date.

The terrain database contains the terrain mapping data. It is updated periodically and has no expiration date.

The obstacle database contains data for obstacles, such as towers, that pose a potential hazard to aircraft. Obstacles 200 feet and higher are included in the obstacle database. It is very important to note that not all obstacles are necessarily charted and therefore may not be contained in the obstacle database. This database is updated on a 56-day cycle.



NOTE: The data contained in the terrain and obstacle databases comes from government agencies. Garmin accurately processes and cross-validates the data, but cannot guarantee the accuracy and completeness of the data.

The AOPA or AC-U-KWIK Airport Directory provides detailed information about airports and heliports, along with the names and phone numbers of thousands of FBOs. The AOPA Airport Directory covers U.S. airports, while the AC-U-KWIK Airport Directory coverage area may be worldwide or regional, depending on the database purchased. Both AOPA and AC-U-KWIK Airport Directory databases are updated every 56 days.

The SafeTaxi database contains detailed airport diagrams for selected airports. These diagrams aid in following ground control instructions by accurately displaying the aircraft position on the map in relation to taxiways, ramps, runways, terminals, and services. This database is updated on a 56-day cycle.

The FliteCharts database contains procedure charts for the United States only. This database is updated on a 28-day cycle. If not updated within 180 days of the expiration date, FliteCharts will no longer function.

AUTOMATIC DATABASE SYNCHRONIZATION FEATURE

The automatic database synchronization feature automatically transfers a database from one Supplemental Data Card to the other Supplemental Data Card to ensure that all databases are synchronized throughout the system. After power-up, the system compares all copies of each applicable database. If similar databases do not match, the most recent valid database is automatically copied to each card in the system that does not already contain that database.

The following databases are checked and synchronized: Basemap, SafeTaxi, Obstacle, and Airport Directory (AOPA or AC-U-KWIK). This feature applies only to databases that are stored on the Supplemental Data Card that resides in the bottom slot of each display. This feature does not apply to the active navigation database which is stored internally in each display, the terrain database, or the charts databases (FliteCharts and ChartView), which are only required to be present on the MFD.

The synchronization progress may be monitored on the AUX-System Status Page in the Sync Status section of the Database Window (Figure B-8). This section shows the synchronization status of each applicable database, including the percent complete, time remaining, and to which displays the databases are being copied. When the synchronization is complete, the status is listed as 'Complete', followed by the displays to which the databases were copied. This sub-section is only present when a sync is occurring or has occurred on the current power-up.

An indication of 'Complete' still requires a power cycle before the synchronized databases will be used by the system.

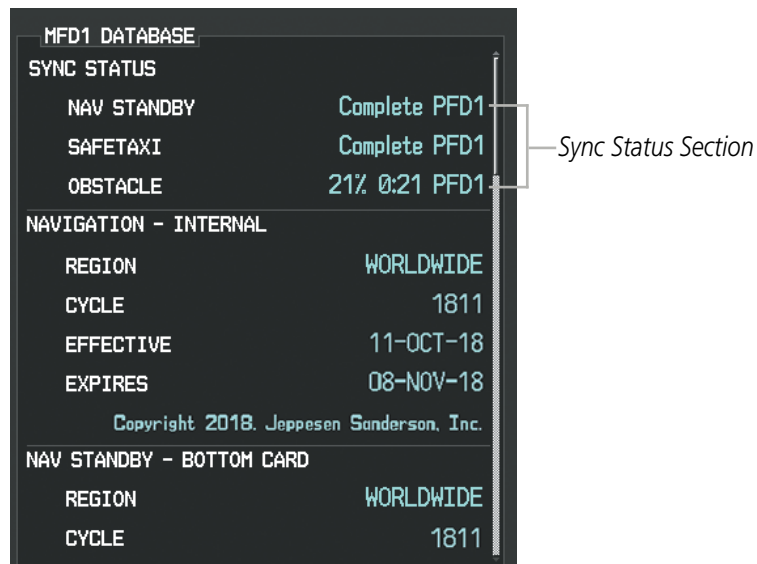
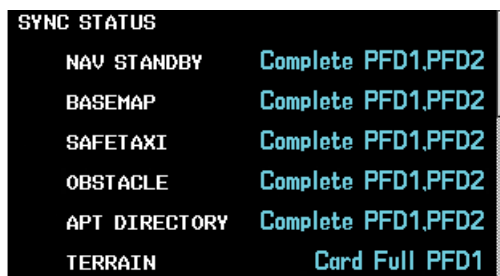

Figure B-9 AUX-System Status Page, Database Window

The Display Database Softkey (Figure B-12) is used to place the cursor in the Database Window. Upon first press of the Display Database Softkey, the softkey will change to a selected state (black text on gray background) and the cursor will appear in the Database Window. At this point the user can scroll through all databases in the Database Window to view status information. If the Display Database Softkey is pressed repeatedly, the softkey will switch between PFD1 and MFD1. Database status information in the Database

Window will reflect the database of the selected display. After a successful sync and restart, verify that the proper databases are now in use on the AUX–System Status Page (Figure B-9).

If an error occurs during the synchronization, an error message will be displayed, followed by the affected display in the Sync Status section of the Database Window (Figure B-10). If a synchronization completes on one display, but an error occurs on the other, the error message will be displayed with the affected display listed after it. When an error message (Table B-1) is displayed, the problem must be corrected before the synchronization can be completed. A power cycle is required to restart synchronization when ‘Card Full’ or ‘Err’ is shown.



‘Card Full’ Message

Figure B-10 Synchronization Error Message

Error Message	Description
Canceled	Database synchronization has been canceled by removing the bottom SD card in display being updated
Card Full	SD card does not contain sufficient memory
Err	Displayed for all other errors that may cause the synchronization process to be halted
Timeout	System timed-out prior to the database transfer completing

Table B-1 Database Synchronization Error Messages

UPDATING GARMIN DATABASES

The Garmin database updates can be obtained by following the instructions detailed in the ‘Aviation Databases’ section of the Garmin website (fly.garmin.com). Once the updated files have been downloaded from the website, a PC equipped with an appropriate SD card reader is used to unpack and program the new databases onto an existing Supplemental Data Card. Equipment required to perform the update is as follows:

- Windows-compatible PC computer (running Windows XP, Vista, or Windows 7)
- SD Card Reader: SanDisk SDDR-93, SanDisk SDDR-99, Verbatim #96504, or equivalent
- Updated database obtained from the Garmin website
- Existing Supplemental Database SD Cards (010-00330-42, or -43) from the PFD and MFD

In some cases it may be necessary to obtain an unlock code from Garmin in order to make the database product functional. It may also be necessary to have the system configured by a Garmin authorized service facility in order to use some database features.

UPDATING BASEMAP, SAFETAXI, OBSTACLE, AND AIRPORT DIRECTORY DATABASES

These databases may be copied to one Supplemental Data Card, then automatically synchronized to other card in the system:

- 1) With system power OFF, remove the MFD database card from the bottom card slot of the MFD.
- 2) Update the basemap, SafeTaxi, obstacle and/or airport directory databases on the MFD card.
- 3) Insert the MFD database card into the bottom card slot of the MFD.
- 4) Apply power to the system, check that the databases are initialized and displayed on the Power-Up Page (Figure B-11). If a 'Verifying' message is seen, wait for the system to finish loading before proceeding to step 5.

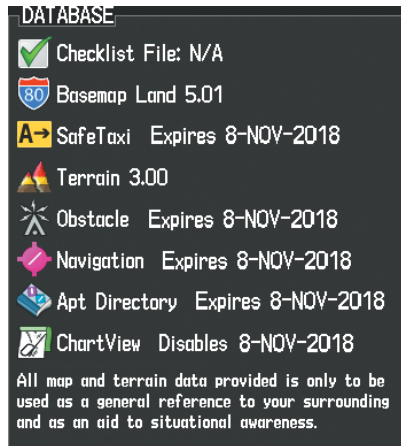

Figure B-11 Database Information on the Power-up Page

- 5) Acknowledge the Power-up Page agreement by pressing the **ENT** Key or the right most softkey.
- 6) Turn the large **FMS** Knob to select the AUX Page group on the MFD.
- 7) Turn the small **FMS** Knob to select the System Status Page.
- 8) Monitor the Sync Status in the Database Window. Wait for all databases to complete synchronization, indicated by 'Complete' being displayed as seen in Figure B-10.
- 9) Remove and reapply power to the system.
- 10) Turn the large **FMS** Knob to select the AUX Page group on the MFD.
- 11) Turn the small **FMS** Knob to select the System Status Page.
- 12) Press the Display Database Selection Softkey to show database information for each display (**MFD1 DB, PFD1 DB**). Verify the correct database cycle information is shown for each database for each display.



Figure B-12 Display Database Softkey

UPDATING TERRAIN, FLITECHARTS, AND CHARTVIEW DATABASES

- 1) With system power OFF, remove the Supplemental Data Card from the bottom card slot of the MFD and both PFDs.
- 2) Copy the updated terrain database to both Supplemental Data Cards. Copy the updated FliteCharts or ChartView database to one Supplemental Data Card.
- 3) Insert the updated Supplemental Data Cards into the bottom card slot of the MFD and PFDs. The Supplemental Data Card containing the FliteCharts or ChartView database is inserted in the MFD.
- 4) Apply power to the system, check that the databases are initialized and displayed on the Power-Up Page (Figure B-10). A 'Verifying' message may be seen. If this message is present, wait for the system to finish loading before proceeding to step 5.
- 5) Acknowledge the Power-up Page agreement by pressing the **ENT** Key or the right most softkey.
- 6) Turn the large **FMS** Knob to select the AUX Page group on the MFD.
- 7) Turn the small **FMS** Knob to select the System Status Page.
- 8) Press the Display Database Selection Softkey to show database information for each display (**MFD1 DB, PFD1 DB, or PFD2 DB**). Verify the correct database cycle information is shown for each database for each display.
- 9) Remove power from the system.

MAGNETIC FIELD VARIATION DATABASE UPDATE

A copy of the current magnetic field variation database (MV DB) is included with the navigation database. At startup, the system compares this version of the MV DB with that presently being used by each AHRS (GRS1 and optional GRS2). If the system determines the MV DB needs to be updated, a prompt is displayed on the Navigation Map Page, similar to Figure B-13. Note, in the following example, GRS1 is the first AHRS to indicate an update is available. In actuality, this is dependent on which AHRS is the first to report status to the system. GRS2 may be displayed before GRS1. The order is not important, only that each AHRS be updated, if more than one is installed.

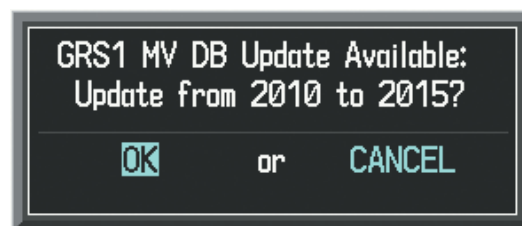

Figure B-13 GRS1 Magnetic Field Variation Database Update Prompt

Loading the magnetic field variation database update (single or dual AHRS):

- 1) With 'OK' highlighted, as seen in Figure B-13, press the **ENT** Key on the MFD. A progress monitor is displayed as shown in Figure B-14.

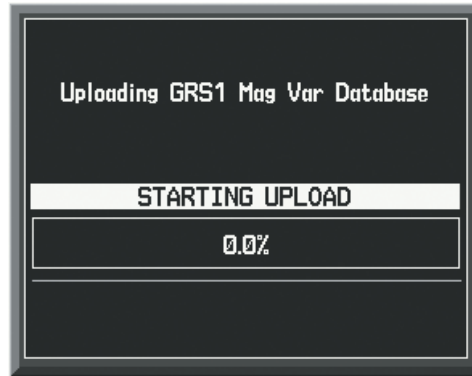

Figure B-14 Uploading Database to GRS1

- 2) If a single GRS is installed, the system is ready for use when the upload is complete. Otherwise, continue the procedure to update the other GRS.
- 3) The system displays a prompt for the next GRS upload is displayed, as seen in Figure B-15.

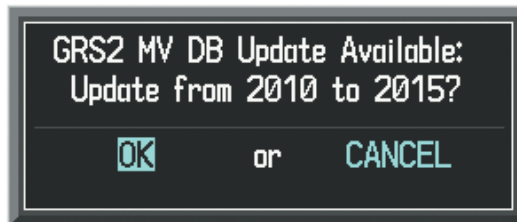

Figure B-15 GRS2 Magnetic Field Variation Database Update Prompt

- 4) With 'OK' highlighted, press the **ENT** Key on the MFD. A progress monitor is displayed as shown in Figure B-16. When the upload is complete, the system is ready for use.

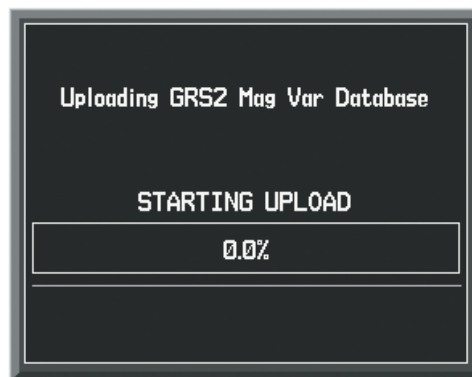

Figure B-16 Uploading Database to GRS2

SYSTEM
OVERVIEW

FLIGHT
INSTRUMENTS

EIS

AUDIO PANEL
& CNS

FLIGHT
MANAGEMENT

HAZARD
AVOIDANCE

AFCS

ADDITIONAL
FEATURES

APPENDICES

INDEX

BLANK PAGE

AVIATION TERMS AND ACRONYMS

A	Amps	ANT	Antenna
AC	Advisory Circular, Alternating Current	AOA	Angle of Attack, ACARS Over AVL
ACARS	Airborne Communications Addressing and Reporting System	AOC	Aeronautical Operational Control
ACC	Accuracy	AOG	Aircraft On Ground
ACK	Acknowledge	AOPA	Aircraft Owners and Pilots Association
ACT, ACTV	Active, Activate, Altitude Compensated Tilt	AP	Autopilot
ADAHRS	Air Data, Attitude and Heading Reference System	AP DISC	Autopilot Disconnect
ADC	Air Data Computer	APPR, APR	Approach
ADF	Automatic Direction Finder	APT	Airport, Aerodrome
ADI	Attitude Direction Indicator	APTSIGNS	Airport Signs
ADIZ	Air Defense Identification Zone	ARINC	Aeronautical Radio Incorporated
ADS-B	Automatic Dependent Surveillance-Broadcast	ARSPC	Airspace
ADS-R	Automatic Dependent Surveillance-Rebroadcast	ARTCC	Air Route Traffic Control Center
AEA	Aircraft Electronic Association	ARV	Arrival
AF	Arc to Fix Leg	AS	Airspeed
AFCS	Automatic Flight Control System	ASB	Aviation Support Branch
AFM	Airplane Flight Manual	ASOS	Automated Surface Observing System
AFN	ATS Facilities Notification	AT	Auto Throttle
AFMS	Airplane Flight Manual Supplement	ATC	Air Traffic Control
AFRM	Airframe	ATCRBS	ATC Radar Beacon System
AGL	Above Ground Level	ATIS	Automatic Terminal Information Service
AHRS	Attitude and Heading Reference System	ATK	Along Track
AIM	Aeronautical Information Manual	ATN	Aeronautical Telecommunications Network
AIRB	Airborne	ATS	Air Traffic Services
AIRMET	Airman's Meteorological Information	AUTOSEQ	Automatic Sequence
AIRREP	Air Reports	AUX	Auxiliary
ALRT	Alert	AVG	Average
ALT	Altitude	AVLC	Aviation VHF Link Control
ALT, ALTN	Alternator, Alternate	AWOS	Automated Weather Observing System
ALTS	Selected Altitude Capture Mode	B	Both Runways
ALTV	VNAV Altitude Capture Mode	B ALT	Barometric Altitude
AM	Amplitude Modulation	BARO	Barometer, Barometric
AMPS	Amperes	BATT	Battery
ANNUNC/ANN	Annunciation/Annunciator	BC	Backcourse
		Bearing	The compass direction from the present position to a destination waypoint.

BFO	Beat Frequency Oscillator	Course	The line between two points to be followed by the aircraft.
BKSP	Backspace	Course to Steer	The recommended direction to steer in order to reduce course error or stay on course. Provides the most efficient heading to get back to the desired course and proceed along the flight plan.
Bluetooth	Wireless standard for data exchange over short distances	CPDLC	Controller Pilot Datalink Communications
BOC	Bottom of Climb	CPL	Couple
BOD	Bottom of Descent	CR	Course to Radial Leg
BRG	see also Bearing	CRG	Cockpit Reference Guide
°C	Degrees Celsius	CRNT	Current
C	Center Runway	Crosstrack Error	The distance the aircraft is off a desired course in either direction, left or right.
CA	Course to Altitude Leg	CRS	see also Course, Course to Steer
CAL	Calibrated	CRSR	Cursor
CALC	Calculator	CSA	Conflict Situational Awareness
Calibrated Airspeed	Indicated airspeed corrected for installation and instrument errors.	CSC	Current Speed Control
CAS	Crew Alerting System	CTA	Control Area
CCG	Current Climb Gradient	CTR	Center
CD	Course to DME Distance Leg	CTRL	Control
CDA	Current Data Authority	Cumulative, CUM	The total of all legs in a flight plan.
CDI	Course Deviation Indicator	CVDR	Cockpit Voice Data Recorder
CDU	Control Display Unit	CVR	Cockpit Voice Recorder
CF	Course to Fix Leg	CVRG	Coverage
CG	Center of Gravity	CWS	Control Wheel Steering
CH, CHNL	Channel	CYC CTR	Cyclic Centering
CHT	Cylinder Head Temperature	CYL	Cylinder
CHKLIST	Checklist	D ALT	Density Altitude
CI	Course to Intercept Leg	D-ATIS	Digital Automatic Terminal Info Service
CLD	Cloud	DB, DBASE	Database
CLR	Clear	dBZ	Decibels 'Z' (Radar Return)
CM	Centimeter	DCL	Departure Clearance
CMC	Central Maintenance Computer	DCLTR, DECLTR	Declutter
CN	Canada	DEC FUEL	Decrease Fuel
CNS	Communication, Navigation, & Surveillance	DEG	Degree
CO	Carbon Monoxide	DEIC, DEICE	De-icing
COM	Communication Radio	DEP	Departure
CONFIG	Configuration		
COOL	Coolant		
COPLT	Copilot		

Desired Track	The desired course between the active "from" and "to" waypoints.	Efficiency	A measure of fuel consumption, expressed in distance per unit of fuel.
DES, DEST	Destination	EGNOS	European Geostationary Navigation Overlay Service
DEV	Deviation	EGT	Exhaust Gas Temperature
DF	Direct to Fix Leg	EICAS	Engine Indication and Crew Alerting System
DFLT	Default	EIS	Engine Indication System
DG	Directional Gyro	ELEV	Elevation, Elevator
DGRD	Degrade	ELT	Emergency Locator Transmitter
DH	Decision Height	EMER, EMERG, EMERGENCY	Emergency
Dilution of Precision	A measure of GPS satellite geometry quality on a scale of one to ten (lower numbers equal better geometry, where higher numbers equal poorer geometry).	EMI	Electromagnetic Interference
DIR	Direction	END, ENDUR	Endurance
DIS	Distance	Endurance	Flight endurance, or total possible flight time based on available fuel on board.
Distance	The 'great circle' distance from the present position to a destination waypoint.	ENG	Engine
DL LTNG	Datalink Lightning	ENGD	Engaged
DLS	Data Link System	ENR	Enroute; ETE to Final Destination
DME	Distance Measuring Equipment	Enroute Safe Altitude (ESA)	Uses Grid MORAs to determine a safe altitude within ten miles left or right of the desired course on an active flight plan or direct-to.
DN	Down	ENT	Enter
DNALT	Density Altitude	EPE	see also Estimated Position Error
DOD	Department of Defense	EPU	Estimated Position Uncertainty
DOP	see also Dilution of Precision	ERR	Error
DP	Departure Procedure	ES	Extended Squitter
DPRT	Departure	ESA	see also Enroute Safe Altitude
DR	Dead Reckoning	ESP	Electronic Stability and Protection
DSBL	Disabled	Estimated Position Error (EPE)	A measure of horizontal GPS position error derived by satellite geometry conditions and other factors.
DSP	Datalink Service Provider, Digital Signal Processor	Estimated Time of Arrival (ETA)	The estimated time at which the aircraft should reach the destination waypoint, based upon current speed and track.
DTG	Distance To Go, Remaining distance to last active FPL waypoint	Estimated Time Enroute (ETE)	The estimated time it takes to reach the destination waypoint from the present position, based upon current groundspeed.
DTK	see also Desired Track	ETA	see also Estimated Time of Arrival
DQR	Data Quality Requirements	ETE	see also Estimated Time Enroute
E	Empty, East	EVS	Enhanced Vision System
EAS	Engine and Airframe Systems		
ECU	Engine Control Unit		
EDM	Emergency Descent Mode		
EFC	Expected Further Clearance		

SYSTEM OVERVIEW	EXPIRD	Expired	Fuel Flow	The fuel flow rate, expressed in units of fuel per hour.
	°F	Degrees Fahrenheit	Fuel On Board	The total amount of usable fuel on board the aircraft.
	FA	Course From Fix to Altitude Leg	Fuel Over Destination	The estimated fuel remaining when the aircraft reaches the destination waypoint, based upon current fuel flow.
	FAA	Federal Aviation Administration	FWD	Forward
	FADEC	Full Authority Digital Engine Control	G/S	Glideslope
	FAF	Final Approach Fix	GA	Go-Around
	FAIL	Failure	GAGAN	GPS aided GEO augmented navigation
	FANS	Future Air Navigation System	GAGL	GPS AGL Altitude
	FAR	Federal Aviation Regulations	GAL, GL	Gallon(s)
	FBO	Fixed Base Operator	GBOX	Gearbox
FLIGHT INSTRUMENTS	FC	Course From Fix to Distance Leg	GBT	Ground Based Transceiver
	FCC	Federal Communication Commission	GCU	Garmin Control Unit
	FCST	Forecast	GCS	Ground Clutter Suppression
	FD	Flight Director, Course From Fix to DME Distance Leg	GDC	Garmin Air Data Computer
	FDE	Fault Detection and Exclusion	GDL	Garmin Satellite Data Link
	FF, FFLOW	see also Fuel Flow	GDR	Garmin Data Radio
	FIS-B	Flight Information Services-Broadcast	GDU	Garmin Display Unit
	FISDL	Flight Information Service Data Link	GEA	Garmin Engine/Airframe Unit
	FL	Flight Level	GEN	Generator
	FLC	Flight Level Change	GEO	Geographic
EIS	FLT	Flight Timer	GFC	Garmin Flight Control
	FLTA	Forward Looking Terrain Avoidance	GIA	Garmin Integrated Avionics Unit
	FM	Course From Fix to Manual Termination Leg	GLONASS	Global Orbiting Navigation Satellite Landing System
	FMS	Flight Management System	GLS	Global Navigation Satellite Landing System
	FOB	see also Fuel On Board	GMA	Garmin Audio Panel System
	FOD	see also Fuel Over Destination	GMC	Garmin Mode Controller
	FPA	Flight Path Angle	GMT	Greenwich Mean Time
	FPL	Flight Plan	GMU	Garmin Magnetometer Unit
	FPM	Feet Per Minute, Flight Path Marker	GND	Ground
	FREQ	Frequency	GPH	Gallons per Hour
AUDIO PANEL & CNS	FRMT	Format	GPN	Garmin Part Number
	FRZ	Freezing	GPS	Global Positioning System
	FSM	Flight System Messages	GPWS	Ground Proximity Warning System
	FSS	Flight Service Station		
	FT	foot/feet		
FLIGHT MANAGEMENT				
HAZARD AVOIDANCE				
AFCS				
ADDITIONAL FEATURES				
APPENDICES				
INDEX				

Grid MORA (Minimum Off—Route Altitude)	One degree latitude by one degree longitude in size and clears the highest elevation reference point in the grid by: a) 1,000 feet where the highest elevation is <5001MSL or b) 2,000 feet where the highest elevation is >5000MSL	HPI	Hover Power Indicator
Groundspeed	The velocity that the aircraft is travelling relative to a ground position.	HPL	Horizontal Protection Level
Ground Track	See Track	HR	Hour
GRS	Garmin Reference System	HRZN HDG	Horizon Heading
GS	Ground Speed, Glideslope	HSDB	High-Speed Data Bus
GSA	Garmin Servo Adapter	HSI	Horizontal Situation Indicator
GSD	Garmin Data Concentrator	HT	Heat
GSL	Geodetic Sea Level	HUL	Horizontal Uncertainty Level
GSR	Garmin Satellite Radio	Hz	Hertz (cycles per second)
GSU	Garmin Sensor Unit	I	Inner Marker
GTS	Garmin Traffic System	IAF	Initial Approach Fix
GTX	Garmin Transponder	IAS	Indicated Air Speed
GW	Gross Weight	IAT	Indicated Air Temperature
GWX	Garmin Weather Radar	IAU	Integrated Avionics Unit
HA	Hold Terminating at Altitude Leg	ICAO	International Civil Aviation Organization
HDG	see also Heading	ICS	Intercom System
HDOP	Horizontal Dilution of Precision	ID	Identification/Morse Code Identifier
Heading	The direction an aircraft is pointed, based upon indications from a magnetic compass or a properly set directional gyro.	IDENT, IDNT	Identification
HF	High Frequency, Hold Terminating at Fix Leg	IEEE	Institute of Electrical & Electronics Engineers
HFOM	see also Horizontal Figure of Merit	IF	Initial Fix
Hg	Mercury	IFR	Instrument Flight Rules
HI	High	IG	Imperial Gallon
HI SENS	High Sensitivity	IGE	In Ground Effect
HM	Hold with Manual Termination Leg	ILS	Instrument Landing System
HNS	Hybrid Navigation System	IMC	Instrument Meteorological Conditions
Horizontal Figure of Merit	A measure of the uncertainty in the aircraft's horizontal position.	IN	Inch
HOV	Hover	INACTV	Inactive
HOV-P	Hover Prediction	INC FUEL	Increase Fuel
hPa	Hectopascal	IND	Indicator, Indicated
		Indicated	Information provided by properly calibrated and set instrumentation on the aircraft panel.
		INFO	Information
		IN Hg	Inches of Mercury
		INS	Inertial Navigation System
		INT	Intersection(s)
		INTEG	Integrity (RAIM unavailable)
		IrDA, IRDA	Infrared Data Association

ISA	International Standard Atmosphere; ISA Relative Temperature	LPV	Localizer Performance with Vertical Guidance
ISO	International Standards Organization	LRU	Line Replaceable Unit
ITT	Inter-Turbine Temperature, Interstage Turbine Temperature	LSB V	Lower Sideband Voice
KEYSTK	Key Stuck	LT	Left
KG	Kilogram	LTNG	Lightning
KHz	Kilohertz	LVL	Level
KM	Kilometer	M	Meter, Middle Marker, Mach
KT	Knot	M_{MO} (V_{MO})	Maximum Speed
		Mach Number	Mach number is the ratio of the true airspeed to the speed of sound.
L	Left, Left Runway	MAG	Magnetic
LAT	Latitude, Lateral	MAG VAR	Magnetic Variation
LBL	Label	MAHP	Missed Approach Hold Point
LB	Pound	MAN IN	Manifold Pressure (inches Hg)
LCD	Liquid Crystal Display	MAN SQ	Manual Squelch
LCL	Local	MANSEQ	Manual Sequence
LDA	Landing Distance Available	MAP	Missed Approach Point
LDG	ETA at Final Destination	MASQ	Master Avionics Squelch
LED	Light Emitting Diode	MAX	Maximum
Left Over Fuel On Board	The amount of fuel remaining on board after the completion of one or more legs of a flight plan or direct-to.	MAXSPD	Maximum Speed (overspeed)
Left Over Fuel Reserve	The amount of flight time remaining, based on the amount of fuel on board after the completion of one or more legs of a flight plan or direct-to, and a known consumption rate.	MB	Marker Beacon
Leg	The portion of a flight plan between two waypoints.	MCP	Maximum Continuous Power
LGND	Legend	MDA	Barometric Minimum Descent Altitude
LIFR	Low Instrument Flight Rules	MEPT	Manual Electric Pitch Trim
LMM	Location Middle Marker	MET	Manual Electric Trim
LNAV	Lateral Navigation	METAR	Aviation Routine Weather Report
LO	Low	MFD	Multi Function Display
LOA	Letter of Authorization	MGRS	Military Grid Reference System
LOC	Localizer	MGT	Measured Gas Temperature
LOI	Loss of Integrity (GPS)	MHz	Megahertz
LOM	Location Outer Marker	MIC	Microphone
LON	Longitude, Longitudinal	MIN	Minimum
LP	Localizer Performance	Minimum Safe Altitude (MSA)	Uses Grid MORAs to determine a safe altitude within ten miles of the aircraft present position.
		MKR	Marker Beacon
		MOA	Military Operations Area
		MON	Monitor

MOV	Movement	PASS	Passenger(s)
MORA	Minimum Off-Route Altitude	PC	Personal Computer
MPEL	Maximum Permissible Exposure Level	PDC	Pre-Departure Clearance
MPM	Meters per Minute	PFD	Primary Flight Display
MSA	see also Minimum Safe Altitude	PG	Pilot's Guide
MSAS	Multi-functional Satellite Augmentation System	PI	Procedure Turn to Course Intercept Leg
MSG	Message	PIREP	Pilot Report
MSL	Mean Sea Level	PIT, PTCH	Pitch
MT, M	Meter	POA	Plain Old ACARS
mV	Millivolt(s)	POH	Pilot's Operating Handbook
MVFR	Marginal Visual Flight Rules	POHS	Pilot's Operating Handbook Supplement
N	North	POS, POSN	Position
NATS	North Atlantic Tracks System	PPH	Pounds per Hour
NAV	Navigation	PPM	Parts per Million
NAVAID	Navigation Aid	P. POS	Present Position
NDA	Next Data Authority	PRES, PRESS	Pressure
NDB	Non-Directional Beacon	PROC	Procedure(s), Procedure Turn
NEXRAD	Next Generation Radar	PROP	Propeller
NG	Gas Producer Rotation Speed	PROX	Proximity
NM	Nautical Mile(s)	PSI	Pounds per Square Inch, Power Situation Indicator
NoPT	No Procedure Turn Required (procedure shall not be executed without ATC clearance)	PT	Procedure Turn
NOTAM	Notice To Airman	PTK	Parallel Track
NP	Power Turbine Speed	PTT	Push-to-Talk
NR	Rotor Speed	PWR	Power
NRST	Nearest	Q	Engine Torque
O	Outer Marker	QFE	Field Elevation Pressure
OAT	Outside Air Temperature	QNH	Sea Level Pressure
OBS	Omni Bearing Selector	QTY	Quantity
OFST	Offset	R	Right, Right Runway
OGE	Out of Ground Effect	RA	Resolution Advisory, Radio Altimeter
OOOI	Out of the gate, Off the ground, On the ground, and In the gate	RAD	Radial
OXY	Oxygen	RAD ALT	Radio Altimeter
P ALT	Pressure Altitude	RAIM	Receiver Autonomous Integrity Monitoring
PA	Passenger Address, Proximity Advisory	RAM	Random Access Memory
		RAT	Ram Air Temperature
		RCVR	Receiver
		REF	Reference

REM	Remaining (fuel remaining), Reminder	SIM	Simulator
REQ	Required	SLD	Supercooled Large Droplet
RES	Reserve (fuel reserve entered by pilot)	SLP/SKD	Slip/Skid
REV	Reverse, Revision, Revise	SMBL	Symbol
RF	Radio Frequency, Constant Radius Turn to Fix Leg	SMS	Short Message System
RFM	Rotorcraft Flight Manual	SNGL	Single
RMI	Radio Magnetic Indicator	SPC	Space
RMT	Remote	SPD	Speed
RNAV	Area Navigation	SPI	Special Position Identification
RNG	Range	SPKR	Speaker
RNP	Required Navigation Performance	SQ	Squelch
RNWX, RWY	Runway	SRVC, SVC	Service
ROL	Roll	SSID	Wireless Service Set Identifier
ROM	Read Only Memory	STAB	Stabilization
RPM	Revolutions Per Minute	STAL	Stall
RST FUEL	Reset Fuel	STAR	Standard Terminal Arrival Route
RSV	Reserve (fuel reserve entered by pilot)	STATS	Statistics
RT	Right	STBY	Standby
RUDICS	Router-Based Unrestricted Digital interworking Connectivity Solution	STD	Standard
RVRSNRY	Reversionary	STRMSCP	Stormscope
RVSM	Reduced Vertical Separation Minimums	SUA	Special Use Airspace
RX	Receive	SURF	Surface
S	South	SUSP	Suspend
SA	Selective Availability	SVT	Synthetic Vision Technology
SAR	Search and Rescue	SW	Software
SAT	Static Air Temperature	SYNC	Synchronize
SBAS	Satellite-Based Augmentation System	SYN TERR	Synthetic Terrain
SCIT	Storm Cell Identification and Tracking	SYN VIS	Synthetic Vision
SD	Secure Digital	SYS	System
SEC	Second(s)	T	True
SEL, SLCT	Select	TA	Traffic Advisory
SELCAL	Selective Calling	TACAN	Tactical Air Navigation System
SENS	Sense	TAF	Terminal Aerodrome Forecast
SFC	Surface	TAS	True Airspeed, Traffic Advisory System
SIAP	Standard Instrument Approach Procedures	TAT	Total Air Temperature
SID	Standard Instrument Departure	TAWS	Terrain Awareness and Warning System
SIG/AIR	SIGMET/AIRMET	TCA	Terminal Control Area
SIGMET	Significant Meteorological Information	TCAS	Traffic Alert Collision Avoidance System
		TEL	Telephone
		TEMP	Temperature

TERM	Terminal	UTM/UPS	Universal Transverse Mercator/ Universal Polar Stereographic Grid
TF	Track Between Two Fixes Leg	V	Volts
TFR	Temporary Flight Restriction	V, Vspeed	Velocity (airspeed)
TGT	Target	V₁	Takeoff Decision Speed
T HDG	True Heading	V₂	Takeoff Safety Speed
TIS	Traffic Information Service	V_A	Maneuvering Speed
TIS-B	Traffic Information Service-Broadcast	V_{APP}, V_{AC}	Approach Climb Speed
TIT	Turbine Inlet Temperature	V_{FE}	Maximum Flap Extended Speed
TKE	see also Track Angle Error	V_{LE}	Maximum Landing Gear Extended Speed
TMA	Terminal Maneuvering Area	V_{LNDx}	Approach Speed (Flaps at x°)
TMR/REF	Timer/Reference	V_{LO}	Maximum Landing Gear Operating Speed
TOC	Top of Climb	V_{MC}	Minimum Control Speed
TOD	Top of Descent, Time to TOD	V_{MO} (M_{MO})	Maximum Operating Speed
TOGA, TO/GA	Take-Off, Go-Around	V_{NE}	Never-Exceed Speed
TOLD	Takeoff and Landing Data	V_R	Takeoff Rotate Speed
TOPO	Topographic	V_{REF}	Landing Approach Speed, Reference Landing Speed
TORA	Takeoff Run Available	V_{SB}	Maximum Speedbrake Speed
TOT	Total	V_{SR}	Stall Speed
TPA	Traffic Pattern Altitude	V_T	Takeoff Flap Retraction Speed
Track	Direction of aircraft movement relative to a ground position; also 'Ground Track'.	V_{TIRE}	Maximum Tire Speed
Track Angle Error	The angle difference between the desired track and the current track.	V_X	Best Angle of Climb Speed
TRK	see also Track	V_Y	Best Rate of Climb Speed
TRSA	Terminal Radar Service Area	V_{YSE}	Best Single-Engine Rate of Climb Speed
TRUNC	Truncated	V DEV	Vertical Deviation
TTL	Total	VA	Heading Vector to Altitude Leg
TURB	Turbulence	VAC	Volts Alternating Current
TURN	Procedure Turn	VAPP	VOR Approach
TWIP	Terminal Weather Information for Pilots	VAR	Variation
TX	Transmit	VD	Heading Vector to DME Distance Leg
UAT	Universal Access Transceiver	VDC	Volts Direct Current
UHF	Ultra-High Frequency	VDL	VHF Datalink
UNAVAIL	Unavailable	VERT	Vertical
US	United States	Vertical Figure of Merit	A measure of the uncertainty in the aircraft's vertical position.
USB V	Upper Sideband Voice		
USR	User		
UTC	Coordinated Universal Time		

Vertical Speed Required	The vertical speed necessary to descend/climb from a current position and altitude to a defined target position and altitude, based upon current groundspeed.	VTF	Vector to Final
VFOM	see also Vertical Figure of Merit	W	Watt(s), West
VFR	Visual Flight Rules	WAAS	Wide Area Augmentation System
VHF	Very High Frequency	WARN	Warning
VI	Heading Vector to Intercept Leg	WATCH	Weather Attenuated Color Highlight
VLOC	VOR/Localizer Receiver	WGS-84	World Geodetic System - 1984
VM	Heading Vector to Manual Termination Leg	WI-FI, WIFI	Wireless Local Area Network based on IEEE 802.11
VMC	Visual Meteorological Conditions	WOG	Weight on Gear
VNAV, VNV	Vertical Navigation	WOW	Weight on Wheels
VOL	Volume	WPT	Waypoint(s)
VOR	VHF Omnidirectional Range	WT	Weight
VORTAC	VHF Omnidirectional Range Station and Tactical Air Navigation	WW	World Wide
VPATH, VPTH	Vertical Path	WX	Weather
VPL	Vertical Protection Level	XFER, XFR	Transfer
VPROF	VNAV Profile, Vertical Profile	XM LTNG	SiriusXM Lightning
VR	Heading Vector to Radial Leg	XMIT	Transmit
VRP	Visual Reporting Point	XMSN	Transmission
VS	Vertical Speed	XPDR	Transponder
VSD	Vertical Situation Display	XTALK	Cross-Talk
VSI	Vertical Speed Indicator	XTK	Cross-Track, Crosstrack Error
VSR, VS REQ	see also Vertical Speed Required	YD	Yaw Damper

FREQUENTLY ASKED QUESTIONS

If a particular aspect of system operational capability is not addressed by these commonly asked questions or in the index, contact Garmin (see the copyright page or back cover for contact information) or a Garmin-authorized dealer. Garmin is dedicated to supporting its products and customers.

WHAT IS SBAS?

The Satellite Based Augmentation System (SBAS) uses a system of ground stations to correct any GPS signal errors. These ground stations correct for errors caused by ionospheric disturbances, timing, and satellite orbit errors. It also provides vital integrity information regarding the health of each GPS satellite. The signal correction is then broadcast through geostationary satellites. This correction information can then be received by any SBAS-enabled GPS receiver.

SBAS is designed to provide the additional accuracy, availability, and integrity necessary to enable users to rely on GPS for all phases of flight.

There are several SBAS systems serving different parts of the world. The Wide Area Augmentation System (WAAS) is currently available in the United States, including Alaska and Hawaii. The European Geostationary Navigation Overlay Service (EGNOS) offers coverage of Europe, parts of the middle east and northern Africa. The Multi-functional Satellite Augmentation System (MSAS) covers mainly Japan. The GPS aided GEO augmented navigation (GAGAN) offers covers mainly India.

HOW DOES SBAS AFFECT APPROACH OPERATIONS?

Both LNAV/VNAV and LPV approaches use the accuracy of SBAS to include vertical (glide path) guidance capability. The additional accuracy and vertical guidance capability allows improved instrument approaches to an expanded number of airports throughout the U.S.

The implementation of LPV approaches further improves precision approach capabilities. LPV approaches are designed to make full use of the improved GPS signal from the SBAS. This approach combines the LNAV/VNAV vertical accuracy with lateral guidance similar to the typical Instrument Landing System (ILS). LPV approaches allow lower approach minimums.

WHAT IS RAIM AND HOW DOES IT AFFECT APPROACH OPERATIONS?

RAIM is an acronym for Receiver Autonomous Integrity Monitoring. RAIM is a GPS receiver function that performs the following functions:

- Monitors and verifies integrity and geometry of tracked GPS satellites
- Notifies the pilot when satellite conditions do not provide the necessary coverage to support a certain phase of flight
- Predicts satellite coverage of a destination area to determine whether the number of available satellites is sufficient to satisfy requirements



NOTE: If RAIM is not predicted to be available for the final approach course, the approach does not become active, as indicated by the "RAIM not available from FAF to MAP" message and the LOI annunciation flagging on the HSI.

For RAIM to work correctly, the GPS receiver must track at least five satellites. A minimum of six satellites is required to allow RAIM to eliminate a single corrupt satellite from the navigation solution.

RAIM ensures that satellite geometry allows for a navigation solution calculation within a specified protection limit (2.0 nm for oceanic and en route, 1.0 nm for terminal, and 0.3 nm for non-precision approaches). The system monitors RAIM and issues an alert message when RAIM is not available (see Appendix A). Without RAIM, GPS position accuracy cannot be monitored. If RAIM is not available when crossing the FAF, the pilot must fly the missed approach procedure.

WHAT IS GSL ALTITUDE?

GSL (Geodetic Sea Level) altitude is the height above Mean Sea Level (MSL), as calculated geometrically, generally using a global positioning system (GPS) as the primary data source. The calculated result may or may not include a barometric component, but the primary source is geometric.

WHY ARE THERE NOT ANY APPROACHES AVAILABLE FOR A FLIGHT PLAN?

Approaches are available for the final destination airport in a flight plan or as a direct-to (keep in mind that some VOR/VORTAC identifiers are similar to airport identifiers). If a destination airport does not have a published approach, the system indicates “NONE” for the available procedures.

WHAT HAPPENS WHEN AN APPROACH IS SELECTED? CAN A FLIGHT PLAN WITH AN APPROACH, A DEPARTURE, OR AN ARRIVAL BE STORED?

When an approach, departure, or arrival is loaded into the active flight plan, a set of approach, departure, or arrival waypoints is inserted into the flight plan, along with a header line showing the title of the selected instrument procedure. The original en route portion of the flight plan remains active, unless the instrument procedure is activated. This may be done either when the procedure is loaded or at a later time.

Flight plans can also be stored with an approach, a departure, or an arrival. Note that the active flight plan is erased when the system is turned off. Also, the active flight plan is overwritten when another flight plan is activated. When storing flight plans with an approach, a departure, or an arrival, the system uses the waypoint information from the current database to define the waypoints. If the database is changed or updated, the system automatically updates the information, provided the procedure has not been modified. Should an approach, departure, or arrival procedure no longer be available, the flight plan becomes locked until the procedure is deleted from the flight plan.

CAN “SLANT GOLF” (“/G”) BE FILED USING THE G1000 SYSTEM?

“/G” may be filed for a flight plan. The system meets the requirements of TSO-C145a Class 3 and ETSO C145 Class 3 installations. GPS approaches are not to be flown with an expired database. See the current version of the pertinent flight manual as well as the Aeronautical Information Manual (AIM) for more information.

WHAT DOES THE OBS SOFTKEY DO?

The **OBS** Softkey is used to select manual sequencing of waypoints. Activating OBS mode sets the current active-to waypoint as the primary navigation reference and prevents the system from sequencing to the next waypoint in a flight plan. When OBS mode is cancelled, automatic waypoint sequencing is continued, and

the system automatically activates the next waypoint in the flight plan once the aircraft has crossed the present active waypoint.

Normal (OBS not activated)	OBS
<ul style="list-style-type: none"> • Automatic sequencing of waypoints 	<ul style="list-style-type: none"> • Manual sequencing - 'holds' on selected waypoint
<ul style="list-style-type: none"> • Manual course change on HSI not possible 	<ul style="list-style-type: none"> • Manually select course to waypoint from HSI
<ul style="list-style-type: none"> • Always navigates 'TO' the active waypoint 	<ul style="list-style-type: none"> • Indicates 'TO' or 'FROM' waypoint
<ul style="list-style-type: none"> • Must be in this mode for final approach course 	<ul style="list-style-type: none"> • Cannot be set for final approach course or published holding patterns

When OBS mode is active, the system allows the pilot to set a desired course to/from a waypoint using the **CRS/BARO** Knob and HSI (much like a VOR).

The most common application for using the **OBS** Softkey is the missed approach. The system suspends automatic waypoint sequencing (indicated by a 'SUSP' annunciation placed on the HSI) when the missed approach point (MAP) is crossed. This prevents the system from automatically sequencing to the missed approach holding point (MAHP). During this time, the **OBS** Softkey designation changes to **SUSP**. Pressing the **SUSP** Softkey reactivates automatic waypoint sequencing. The **OBS** Softkey then resumes its normal functionality.

WHY MIGHT THE SYSTEM NOT AUTOMATICALLY SEQUENCE TO THE NEXT WAYPOINT?

The system only sequences flight plan waypoints when automatic sequencing is enabled (i.e., no 'OBS' or 'SUSP' annunciation on the HSI). For automatic sequencing to occur, the aircraft must also cross the *bisector* of the turn being navigated. The bisector is a line passing through the waypoint common to two flight plan legs at an equal angle from each leg.

HOW CAN A WAYPOINT BE SKIPPED IN AN APPROACH, A DEPARTURE, OR AN ARRIVAL?

The system allows the pilot to manually select any approach, departure, or arrival leg as the active leg of the flight plan. This procedure is performed on the MFD from the Active Flight Plan Page by highlighting the desired waypoint and pressing the **ACT Leg** Softkey then the **ENT** Key to approve the selection. The GPS then provides navigation along the selected flight plan leg.

WHEN DOES TURN ANTICIPATION BEGIN?

The system smooths adjacent leg transitions based on a normal 15° bank angle (with the ability to roll up to 30°) and provides three pilot cues for turn anticipation:

- A waypoint alert ('Next DTK ###° in # seconds' or 'Next HDG ###° in # seconds') appears on the PFD 10 seconds before the turn point and flashes as it counts down to zero.
- A flashing turn advisory ('Turn [right/left] to ###° in # seconds') appears on the PFD 10 seconds before the turn and flashes as it counts down to zero. 'Turn [right/left] to ###° now' or 'Next [DTK/HDG] to ###° now' is displayed when the pilot is to begin the turn and the HSI (GPS mode) automatically sequences to the next DTK or HDG value.
- The To/From indicator on the HSI flips momentarily to indicate that the midpoint of the turn has been crossed.

WHEN DOES THE CDI SCALE CHANGE?

Once a departure is activated, the Course Deviation Indicator (CDI) full scale deflection is set to 0.3 nm. The CDI scale changes to 1.0 nm (terminal mode) then ramps up to 2.0 nm (enroute mode) at 30 nm from the departure airport. When 31 nm from the destination, the CDI scale smoothly transition from 2.0 nm back to 1.0 nm (terminal mode). At 2.0 nm before the FAF during an active approach, the CDI scale transitions down further based on the type of approach activated (LNAV, LNAV/VNAV, LPV). When a missed approach is activated, the CDI is set to 0.3 nm. See the Flight Instruments Section for more details on CDI scaling.

WHY DOES THE HSI NOT RESPOND LIKE A VOR WHEN OBS MODE IS ACTIVE?

Unlike a VOR, the CDI scale used on GPS equipment is based on the crosstrack distance to the desired course, not on the angular relationship to the destination. Therefore, the CDI deflection on the GPS is constant regardless of the distance to the destination and does not become less sensitive when further away from the destination.

WHAT IS THE CORRECT MISSED APPROACH PROCEDURE? HOW IS THE MISSED APPROACH HOLDING POINT SELECTED?

To comply with TSO specifications, the system does not automatically sequence past the MAP. The first waypoint in the missed approach procedure becomes the active waypoint when the **SUSP** Softkey is selected *after* crossing the MAP. All published missed approach procedures must be followed, as indicated on the approach plate.

To execute the missed approach procedure prior to the MAP (not recommended), select the Active Flight Plan Page and use the **ACT Leg** Softkey to activate the missed approach portion of the procedure.

AFTER A MISSED APPROACH, HOW CAN THE SAME APPROACH BE RE-SELECTED? HOW CAN A NEW APPROACH BE ACTIVATED?



NOTE: Do not attempt to reactivate the current approach prior to crossing the missed approach point (MAP). If an attempt to do so is made, an alert message "Are you sure you want to discontinue the current approach?" appears. The system directs the pilot back to the transition waypoint and does not take into consideration any missed approach procedures, if the current approach is reactivated.

After flying the missed approach procedure, the pilot may reactivate the same approach for another attempt by pressing the **PROC** Key. Once the clearance is given for another attempt, activate the approach by highlighting 'Activate Approach' using the large **FMS** Knob and pressing the **ENT** Key. The system provides navigation along the desired course to the waypoint and rejoins the approach in sequence from that point.

To activate a new approach for the same airport, select the new procedure by pressing the **PROC** Key. Choose 'Select Approach', select the desired approach from the list shown, and press the **ENT** Key. Select the desired transition, then activate the approach using the **ENT** Key.

To activate a new approach to a different airport, press the **Direct-to** Key and select the desired airport using the **FMS** Knobs. Press the **ENT** Key to accept the selected airport, then follow the steps in the preceding paragraph to select an approach for the new airport.

MAP SYMBOLS

AIRPORTS

Item	Symbol
Unknown Airport	
Non-towered, Non-serviced Airport	
Towered, Non-serviced Airport	
Non-towered, Serviced Airport	
Towered, Serviced Airport	
Restricted (Private) Airport	
Heliport	

NAVAIDS

Item	Symbol
Intersection	
LOM (compass locator at outer marker)	
NDB (non-directional radio beacon)	
VOR	
VOR/DME	
VOR/ILS	
VORTAC	
TACAN	

BASEMAP

Item	Symbol
Interstate Highway	
State Highway	
US Highway	
National Highway	
City	
State/Province Border	
International Border	
Road	
Railroad	
Latitude/Longitude	

AIRSPACE BOUNDARIES

Item	Symbol
ICAO Control Area	
Class B Airspace	
Mode C Tower Area	
Warning Area	
Alert Area	
Prohibited Area	
Restricted Area	
Caution Area	
Training Area	
Danger Area	
Unknown Area	
Class C	
Terminal Radar Service Area	
Mode C Area	
Military Operations Area (MOA)	

SYSTEM OVERVIEW

FLIGHT INSTRUMENTS

EIS

AUDIO PANEL & CNS

FLIGHT MANAGEMENT

HAZARD AVOIDANCE

AFCS

ADDITIONAL FEATURES

APPENDICES

INDEX

HAZARD AVOIDANCE FEATURES

Feature	Symbol
Terrain display enabled	
NEXRAD Composite (FIS-B only)	
Traffic display enabled	
SiriusXM NEXRAD or Garmin Connex Radar Precipitation display enabled	
Cloud Top display enabled	
Echo Top display enabled	
SiriusXM or Garmin Connex Lightning display enabled	
Cell Movement display enabled	
SIGMETs/AIRMETs display enabled	
METARs display enabled	
City Forecast display enabled	
Surface Analysis display enabled	
Freezing Levels display enabled	
Winds Aloft display enabled	
County Warnings display enabled	
Cyclone Warnings display enabled	
Loss of hazard avoidance feature (loss of GPS position)	













TRAFFIC

Item	Symbol
Non-threat Traffic	
Proximity Advisory	
Traffic Advisory, Beyond Map Range	
Traffic Advisory	









MISCELLANEOUS

Item	Symbol
ARTCC Frequency or FSS Frequency	
Map Pointer (when panning)	
Elevation Pointer (on Topography Scale when panning)	
Measuring Pointer	
Wind Vector	
Overzoom Indicator	
User Waypoint	
Vertical Navigation Along Track Waypoint	
Parallel Track Waypoint	
Unanchored Flight Path Waypoint	
Top of Descent (TOD)	
Bottom of Descent (BOD)	
Navigating using Dead Reckoning	











OBSTACLE DATABASE

Unlighted Obstacle		Lighted Obstacle		Obstacle Location
< 1000' AGL	> 1000' AGL	< 1000' AGL	> 1000' AGL	
				Red obstacle is above or within 100 ft below the aircraft altitude
				Yellow obstacle is between 100 ft and 1000 ft below the aircraft altitude
				Gray obstacle is more than 1000 ft below aircraft altitude

TRAFFIC (TAS)

Item	Symbol
Non-threat Traffic (hollow diamond)	
Proximity Advisory (TAS only)	
Traffic Advisory, Out of Range	
Traffic Advisory	
Traffic Advisory (TA) arrow with ADS-B directional information. Points in the direction of the intruder aircraft track.	
Proximity Advisory (PA) arrow with ADS-B directional information. Points in the direction of the aircraft track .	
Non-threat traffic arrow with ADS-B directional information. Points in the direction of the intruder aircraft track .	
PA or Non-threat traffic arrow with ADS-B directional information, but positional accuracy is degraded. Points in the direction of the aircraft track	

TRAFFIC (ADS-B WITH GDL 88)

Description	
Traffic Advisory with directional information. Points in the direction of the intruder aircraft track.	
Traffic Advisory without directional information.	
Traffic Advisory out of the selected display range. Displayed at outer range ring at proper bearing.	
Proximity Advisory with directional information. Points in the direction of the aircraft track.	
Proximity Advisory without directional information.	
Non-threat traffic with directional information. Points in the direction of the intruder aircraft track.	
Non-threat traffic without directional information.	
Traffic located on the ground with directional information. Points in the direction of the aircraft track. Ground traffic is only displayed when ADS-B is in Surface (SURF) Mode or own aircraft is on the ground.	
Ground traffic without directional information. Ground traffic is only displayed when ADS-B is in Surface (SURF) Mode or own aircraft is on the ground.	
Non-aircraft ground traffic. Ground traffic is only displayed when ADS-B is in Surface (SURF) Mode or own aircraft is on the ground.	

TERRAIN AVOIDANCE COLORS AND SYMBOLS

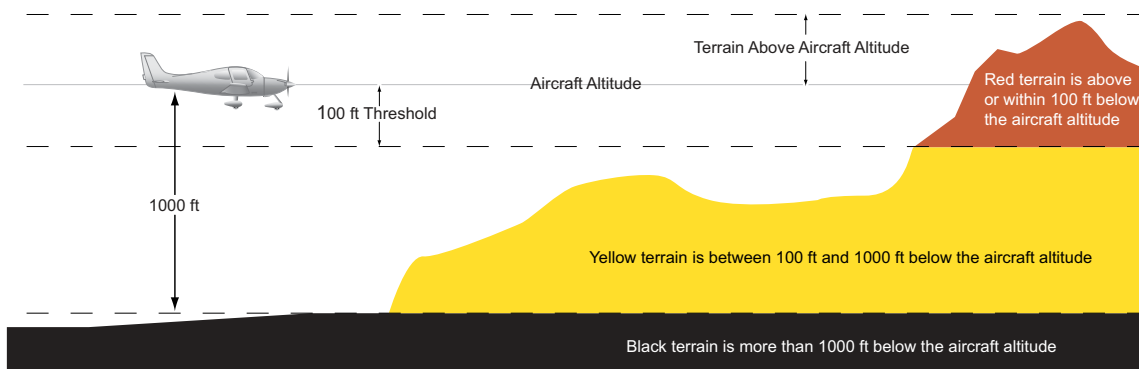

On the dedicated terrain page, a gray shade of purple indicates no terrain data is available.

Figure E-1 Terrain Altitude/Color Correlation



Figure E-2 Terrain-SVS/TAWS-B Potential Impact Points

A

Access Code	359
Activate a Flight Plan	244
Active Channel	605
Active Database	690, 691
Active Frequency	118, 127
AC-U-KWIK	545, 600
ADS-B	449, 717
AFCS Status Annunciation	59
AFCS Status Box	58, 501
AHRS	669, 670, 672, 673, 674
AIRB	483
Air Data Computer	1
Airport	
Information	193, 194, 199
Airport Directory	195, 545, 600
Airspace	178, 214, 215, 216, 217
Airspace Alerts	216, 217
Airspeed Indicator	58, 60
Airways	25
Collapsed/Expanded	257
Alerting System	659
Alert Levels	661
Alerts	659
Aircraft	662
Audio Voice	666
Along Track Offset	249, 250
Altimeter	58, 63
Altitude Alerting	85
Altitude Constraints	266
Altitude Hold Mode	506
Altitude Reference	505, 506, 512
Annunciations	
Test tone	660
Annunciator Lights	143
AOPA	545, 600, 693
AOPA Airport Directory	357, 608
Approach	
Activating	278, 282
ILS	535
Loading	241, 278, 279, 280, 281
Missed	538
Removing	282
WAAS	536
Approach Box	589
Approach Channel	241, 279
Approach Mode	522, 535, 536
Arc HSI	67
Arrival Procedure	239, 275, 276, 277
Assist, Engine Leaning	104–106
Attitude	1
Attitude Indicator	58, 62
Audio Alerting System	660

Audio Panel Fail-Safe Operation	160
Automatic Dependent Surveillance-Broadcast (ADS-B)	449
Automatic Dependent Surveillance-Rebroadcast (ADS-R)	478
Automatic Descent Mode	643, 644, 645
Automatic Flight Control System (AFCS)	497–544
Alerts and annunciations	540–541
Status Annunciations	540, 680
Status Box	501
Automatic Squelch	126
Autopilot	497
Autopilot Disconnect	499, 525
Auto-tuning, COM	121
Auto-tuning, NAV	130, 133
Auto Zoom	167
Auxiliary Pages (AUX)	41
Aviation Symbols	178
Avidyne TAS600	462

B

Backlighting	55
Barometric Altimeter Setting	58
Bearing/Distance, Measuring	173
Bearing Information	59, 70–71
Bearing Source	70
Bluetooth	6, 229, 654, 655
Bottlang VFR Charts	567, 573

C

CDI	677
Chart Not Available	569, 588
Chart Options	578, 595
Chart Setup Box	583, 598
ChartView	545, 567
ChartView Functions	568
ChartView Plan View	579
ChartView Profile View	579
ChartView Softkeys	568
Checklists	638–639
Checklist Softkeys	638
CLD TOP Softkey	336, 374
Closest Point of FPL	257
COM Channel Spacing	125
COM Frequency Box	118
Command Bars	502
Communication (COM) Frequency Window	58
Comparator Window	59, 660
COM tuning failure	160
Conflict Situational Awareness (CSA)	480
Controls	
Softkeys	18–21
Copy a Flight Plan	244

SYSTEM OVERVIEW

FLIGHT INSTRUMENTS

EIS

AUDIO PANEL & CNS

FLIGHT MANAGEMENT

HAZARD AVOIDANCE

AFCS

ADDITIONAL FEATURES

APPENDICES

INDEX

Correlation -----479

Course Deviation Indicator (CDI) -----58, 71–73

Cylinder Head Temperature (CHT °F) ----- 94

D

Databases ----- 27, 689

Database Synchronization ----- 689, 695, 696

Data Link ----- 1

Data Link Receiver -----658

Datalink receiver troubleshooting -----657

Data Logging ----- 545, 641

Date and Time ----- 44

Day/Night views ----- 583, 598

Day View -----583, 584, 598, 599

DB Mismatch -----689

Dead Reckoning (DR)----- 88

Declutter ----- 19, 26

Declutter, Display----- 90

Delete Flight Plans-----245

Deleting

- An Entire Airway ----- 246, 247
- An Entire Procedure ----- 246, 247
- An Individual Waypoint ----- 246, 247
- Flight Plan Items -----246

Departure

- Select-----272, 275, 279, 282
- Time -----286
- Timer ----- 54

Departure Procedure -----237, 272, 273, 274

Digital audio entertainment----- 4

Dilution of Precision (DOP)----- 35

Direct-To----- 218, 219, 220, 221, 222

- Vertical Navigation Direct-To----- 264, 265

Display Backup----- 29

DME

- HOLD mode -----135
- NAV1 mode -----135

DME Information-----59, 71

DME Transceiver Pairing -----135

DME Tuning Window -----135

DR Mode ----- 88

Dual Navigation Database -----690

E

ECHO TOP Softkey -----334

Electronic Checklists-----545, 638, 639, 640

Electronic Stability and Protection (ESP) --- 62, 545, 646, 649, 650

Emergency Checklist -----639

Emergency Frequency -----160

Engine Indication System (EIS)-----91–108

Enhanced Vision System (EVS)----- 545, 560

Entering Flight ID ----- 136

Entertainment Inputs ----- 155

Estimated Position Error (EPE) ----- 35

Ethernet ----- 28

Exhaust Gas Temperature (EGT) ----- 94, 104–105

Exhaust Gas Temperature (EGT)----- 94

Extended Squitter ----- 449, 477

F

Fail-safe Operation ----- 160

Field of View (SVT)----- 189

Flight Director (FD) -----497

- Modes, vertical ----- 503–517

Flight ID -----136

Flight Information Service-Broadcast (FIS-B) --- 679, 716

Flight Level Change Mode----- 508, 531, 534

Flight Path Angle (FPA)-----266

Flight Stream -----6, 229, 545, 654

Flight Timer ----- 53

FliteCharts ----- 545, 586

FliteCharts Functions -----587

Frequency Spacing-----125

Fuel ----- 25

- Calculations -----99
- Efficiency -----288
- Endurance -----288
- Flow ----- 98
- Remaining -----288
- Required -----288
- Statistics -----288

Fuel Calculations-----106

Fuel Flow (FFLOW GPH) ----- 94

Fuel On Board -----288

Fuel Totalizer----- 25

G

Garmin Connex----- 545, 651

Garmin Pilot ----- 654, 655

GDC 74A ----- 1

GDL 69/69A ----- 1, 320

GDL 88 -----6

GDU 1040 ----- 1

GEA 71 ----- 1

Geodetic Sea Level (GSL)-----417, 422, 431

GIA 63W ----- 1

Glidepath Mode (GP)----- 513, 522, 536

Glideslope Indicator ----- 65

Glideslope Mode----- 514, 535

Global Positioning System (GPS) ----- 290, 291, 292

GMA 347 ----- 1, 27

GMA 347 Audio Panel Controls ----- 16, 114

GMA 350 Audio Panel Controls ----- 13, 112

GMU 44 ----- 1
 Go Around Mode ----- 538–539
 Ground Based Transceiver (GBT) -----449
 Ground Speed ----- 58
 GRS 77 ----- 1
 GSL -----417, 422, 431
 GTX 33 ----- 1
 GTX 33 Mode S Transponders ----- 136

H

Heading ----- 58
 Heading Select Mode -----519
 Horizontal Situation Indicator (HSI) -----58, 66–77
 HSI Double Green Arrow-----127
 HSI Magenta Arrow-----127
 HSI Single Green Arrow -----127
 Hypoxia----- 545, 643, 644

I

IDENT function ----- 138, 139, 143
 ID Indicator ----- 129
 ILS approach-----535
 Imminent Obstacle Impact (IOI) 428, 437, 681, 682, 683
 Indicated Airspeed (IAS) ----- 60
 INFO box -----590
 Initialization, System ----- 27
 Inset Map ----- 19, 59
 Intercom System (ICS)-----155
 Intersection
 Information ----- 200–201
 Nearest -----201
 Inverting a Flight Plan----- 244, 254
 Iridium -----357, 608, 609, 610, 616, 617, 620
 Iridium Satellite Network ----- 609, 620

J

Jeppesen Navigation Database -----689

K

Key(s) ----- 9, 10

L

Land Symbols-----177
 Lightning ----- 19
 LPV -----526

M

Mach Number ----- 58
 Magnetometer ----- 1
 Manifold Pressure-----94, 98
 Map Pages ----- 40

Map Symbols -----715
 Marker Beacon ----- 83, 133
 MASQ processing -----109
 Measurement Units, Changing Displayed----- 45
 Menus ----- 38
 Message Advisories-----661
 Messages Window-----637
 Minimum Descent Altitude, Barometric ----- 86
 Minimum Descent Altitude (MDA) ----- 59
 MISCOMP -----665
 Missed Approach----- 283, 538
 Mode S -----136
 Mode Selection Softkeys----- 136, 137
 Morse Code Identifier -----129
 Motion Vectors -----487
 Multi Function Display (MFD)
 Softkeys----- 24

N

National Weather Service (NWS) -----348
 Navigation Mode ----- 520–521, 529–530
 Navigation Mode Selection -----127
 Navigation (NAV) Frequency Window ----- 58
 Navigation Source ----- 71–73
 Navigation Status Box ----- 58
 Nav Radio Selection -----127
 Nearest
 Airport -----196, 197, 198, 199
 Airport Minimum Runway Length -----199
 Airport Surface Matching -----199
 VOR -----205
 VRP-----207
 Nearest Airports, Frequency Tuning -----121
 Nearest Pages (NRST) ----- 42
 NEXRAD Softkey ----- 330, 371
 NextGen-----477
 Night View -----583, 585, 598, 599
 Non-Path Descent -----512, 534–535
 Normal Display Operation ----- 28

O

OBS Mode----- 76–77
 Obstacles----- 671, 674
 Oil Pressure (OIL PSI)-----94, 98
 Oil Temperature (OIL °F) ----- 94
 Omni Bearing Selector (OBS)----- 712–713
 Other Statistics -----288

P

Page Groups ----- 39–42
 Pairing -----654
 Parallel Track----- 250, 251, 252

SYSTEM OVERVIEW

FLIGHT INSTRUMENTS

EIS

AUDIO PANEL & CNS

FLIGHT MANAGEMENT

HAZARD AVOIDANCE

AFCS

ADDITIONAL FEATURES

APPENDICES

INDEX

Pending Flight Plan ----- 229, 230, 231

Percent Power Indicator-----94, 98

Pilot Profiles ----- 47–48

PIREP ----- 382, 407

PIT -----665

Pitch Hold Mode -----504

Pitch Indication----- 62

Power-up Page -----638

Predefined Message----- 624, 625, 627

Primary Flight Display (PFD)

 Softkeys----- 18–20

Procedures

 GFC 700----- 526–543

Profile View ----- 25

Q

Quick Tuning 121.500 MHz ----- 120

R

Radar Altitude -----480

Range Ring -----187

Receiver Autonomous Integrity Monitoring (RAIM)35–36, 290, 291, 292, 711

Register-----359

Reversionary Mode -----29–30, 32

Reversionary Sensor Window -----661

ROC ----- 428, 437, 681, 682, 683

Roll Hold Mode-----518

RS-232-----4

RS-485-----3

RX Indicator-----119

S

SafeTaxi----- 545, 564

SBAS ----- 290, 291, 292, 674, 711

Scheduler-----545–546, 636

Secure Digital (SD) card----- 638, 689

Selected Altitude - 58, 85, 504, 505, 507, 508, 509, 512

Selected Altitude Capture Mode504, 505, 506, 507, 509, 516

Selected Altitude Intercept Arc----- 190

Selected Altitude Range Arc----- 11, 63

Selected Course -----59, 68

Selected Heading ----- 59, 67, 519

Selecting a COM radio -----118

Sensor -----665

Sequencing Waypoints

 Automatic -----713

Short Message Service (SMS) -- 545, 608, 620, 621, 625

SIGMET ----- 376, 399

SiriusXM-----545, 603, 604, 657

 Radio-----320

 XM Satellite Weather -----320

SiriusXM Channel List -----605

SiriusXM Lightning----- 19

SiriusXM Radio-----604

SiriusXM Radio, Entertainment -----156

SiriusXM Radio Presets -----606

SiriusXM Radio Volume -----607

SiriusXM Satellite Radio ----- 603, 605

SiriusXM Service Class -----604

SiriusXM Weather----- 4

 AIRMETs----- 376, 399

 SIGMETs----- 376, 399

Skywatch-----469

Slip/Skid Indicator-----58, 62

Smart Airspace -----217

Softkeys

 LTNG -----337

 MFD ----- 24

 PFD ----- 18–20

Speaker-----143

Split COM Operation -----154

Standby Frequency----- 118, 121, 127

Standby Frequency Field -----118

Standby Navigation Database -----691, 692, 693

Stereo Headsets-----143

Stormscope Lightning Data -----19

Stuck Microphone -----160

Sunrise/Sunset-----287

SURF -----483

SVT Troubleshooting-----656

Symbols, Map-----715

Synthetic Vision Technology (SVT)----- 62, 545, 546, 677

System Annunciations-----659

System Page (EIS)-----106

System Time-----58

T

Tachometer (RPM)-----94, 98

TAF ----- 340, 377

Takeoff Mode-----516

TAS -----669

TAWS ----- 443, 684

Telephone -----545, 608, 609, 610

Terminal Procedures Charts ----- 569, 587

Terrain ----- 19, 25, 671

 Color indications -----718

Terrain Awareness and Warning System (TAWS)-----682

 Annunciation -----85

Terrain Proximity -----417

Terrain-SVS-----422, 497, 544, 646

Text Message -----620, 621, 624, 627

Timer

 Departure----- 54

 Flight-----53

- Timer, PFD Generic----- 52
- Topographical Data----- 19, 25, 174, 175
- TOPO Scale----- 176
- Track ----- 66
- Track Vector----- 185
- Traffic ----- 25
 - Annunciation ----- 59, 84
- Traffic Information Service-Broadcast (TIS-B)----- 479
- Traffic Information Service (TIS)
 - Voice alerts----- 84
- Transponder----- 23
- Transponder Code Entry ----- 140
- Transponder Data Box----- 109
- Transponder Mode Field ----- 109, 138, 139, 140
- Transponder Standby Mode ----- 138, 139
- Transponder Status Box----- 58
- Trend Vector
 - Turn Rate ----- 69
- Trip Planning----- 286, 287, 288
- Trip Statistics----- 287, 288
- True Airspeed ----- 60
- Turn Anticipation----- 713
- Turn Rate Indicator ----- 58, 69
- TX indicator----- 119

U

- Unable to Display Chart ----- 569, 588
- Universal Access Transceiver (UAT)----- 477
- User-Defined Holding Pattern----- 258, 259, 260, 261

V

- Vertical Deviation ----- 511
- Vertical Deviation Indicator (VDI)----- 65
- Vertical Navigation
 - Along Track Offset ----- 222
 - Direct-to ----- 265, 266
 - For the Flight Plan ----- 264, 265, 266
- Vertical Navigation Flight Control----- 509–513
- Vertical Path Tracking Mode----- 509–510, 532
- Vertical Speed Indicator (VSI)----- 58, 65
- Vertical Speed Mode ----- 507
- Vertical Speed Reference ----- 507
- VFR code ----- 142
- VNAV ----- 678
- VNAV Target Altitude----- 509–512
- VNAV Target Altitude Capture Mode ----- 512
- VNV indications, PFD----- 82
- Voice Alerts, TIS Traffic----- 475
- VOR
 - Information ----- 204
 - Nearest ----- 205

- VOR Selection ----- 127
- VRP
 - Information ----- 206
 - Nearest ----- 206, 207
- Vspeed References----- 61
- VS TGT----- 266

W

- WAAS----- 292, 526, 711
- WAAS Precision Approach----- 536
- Waypoint
 - Automatic sequencing ----- 713
 - Skipping ----- 713
- Waypoint Pages (WPT)----- 40
- Waypoint Selection Submenu-- 219, 226, 232, 233, 290
- Weather ----- 4
- Wi-Fi ----- 545, 631, 635
- Wind Data ----- 21, 59, 80
- Winds Aloft ----- 379
- WIND Softkey----- 345, 379, 404
- Wind Vector on MFD ----- 185, 186

SYSTEM OVERVIEW

FLIGHT INSTRUMENTS

EIS

AUDIO PANEL & CNS

FLIGHT MANAGEMENT

HAZARD AVOIDANCE

AFCS

ADDITIONAL FEATURES

APPENDICES

INDEX

BLANK PAGE



GARMIN®



Garmin International, Inc.
1200 East 151st Street
Olathe, KS 66062, U.S.A.

Garmin AT, Inc.
2345 Turner Road SE
Salem, OR 97302, U.S.A.

Garmin (Europe) Ltd.
Liberty House, Hounsdown Business Park
Southampton, Hampshire SO40 9LR U.K.

Garmin Corporation
No. 68, Zhangshu 2nd Road
Xizhi District,
New Taipei City, Taiwan

Contact Garmin Product Support at www.flygarmin.com

For warranty information refer to www.flygarmin.com