

GARMIN▲

G3X™ Touch

Pilot's Guide for Certified Aircraft



SYSTEM OVERVIEW

FLIGHT INSTRUMENTS

EIS

CNS INTERFACE

GPS NAVIGATION

FLIGHT PLANNING

HAZARD AVOIDANCE

ADDITIONAL FEATURES

AFCS

ANNUNCIATIONS & ALERTS

APPENDIX

INDEX

Blank Page

©2023 Garmin Ltd. or its subsidiaries. All rights reserved.

This manual reflects the operation of System Software version 9.15 or later. Some differences in operation may be observed when comparing the information in this manual to earlier or later software versions.

Garmin International, Inc., 1200 East 151st Street, Olathe, Kansas 66062, U.S.A.

Garmin Product Support: www.fly.garmin.com

Garmin AT, Inc., 2345 Turner Road SE, Salem, OR 97302, U.S.A.

Garmin Product Support: www.fly.garmin.com

Garmin (Europe) Ltd, Liberty House, Hounsdown Business Park, Southampton, Hampshire SO40 9LR, U.K.

Garmin Product Support: www.fly.garmin.com

Garmin Würzburg GmbH, Beethovenstrasse 1a, 97080 Würzburg, Germany

Garmin Product Support: www.fly.garmin.com

Garmin Corporation, No. 68, Zhangshu 2nd Road, Xizhi District, New Taipei City, Taiwan

Garmin Product Support: www.fly.garmin.com

Web Site Address: www.garmin.com

Except as expressly provided herein, no part of this manual may be reproduced, copied, transmitted, disseminated, downloaded or stored in any storage medium, for any purpose without the express written permission of Garmin. Garmin hereby grants permission to download a single copy of this manual and of any revision to this manual onto a hard drive or other electronic storage medium to be viewed for personal use, provided that such electronic or printed copy of this manual or revision must contain the complete text of this copyright notice and provided further that any unauthorized commercial distribution of this manual or any revision hereto is strictly prohibited.

Garmin, GNC, GDL, FliteCharts, SafeTaxi, and MapSource are registered trademarks of Garmin Ltd. or its subsidiaries. ANT+, GTN, GNX, GDU, and G3X are trademarks of Garmin Ltd. or its subsidiaries. These trademarks may not be used without the express permission of Garmin.

Jeppesen is a registered trademark of Jeppesen, Inc.

NavData is a trademark of Jeppesen, Inc.

SiriusXM Weather is provided by SiriusXM Satellite Radio, Inc.

SiriusXM Radio is provided by SiriusXM Satellite Radio, Inc.

The Bluetooth word mark and logos are registered trademarks owned by Bluetooth SIG, Inc. and any use of such marks by Garmin is under license

This product is ANT+™ certified. Visit www.thisisant.com/directory for a list of compatible products and apps.





WARNING: Navigation and terrain separation must NOT be predicated upon the use of the terrain function. The G3X Touch™ Terrain Proximity feature is NOT intended to be used as a primary reference for terrain avoidance and does not relieve the pilot from the responsibility of being aware of surroundings during flight. The Terrain Proximity feature is only to be used as an aid for terrain avoidance and is not certified for use in applications requiring a certified terrain awareness system. Terrain data is obtained from third party sources. Garmin is not able to independently verify the accuracy of the terrain data.



WARNING: To reduce the risk of unsafe operation, carefully review and understand all aspects of the G3X Touch Pilot's Guide documentation and the Pilot's Operating Handbook of the aircraft. Thoroughly practice basic operation prior to actual use. During flight operations, carefully compare indications from the G3X Touch to all available navigation sources, including the information from other NAVAIDs, visual sightings, charts, etc. For safety purposes, always resolve any discrepancies before continuing navigation.



WARNING: The displayed minimum safe altitudes (MSAs) are only advisory in nature and should not be relied upon as the sole source of obstacle and terrain avoidance information. Always refer to current aeronautical charts for appropriate minimum clearance altitudes.



WARNING: The altitude calculated by G3X Touch internal GPS receivers is geometric height above Mean Sea Level and could vary significantly from the altitude displayed by pressure altimeters. Always use pressure altitude displayed by the G3X Touch PFD when determining or selecting aircraft altitude.



WARNING: Do not use outdated database information. Databases used in the G3X Touch system must be updated regularly in order to ensure the information remains current. Pilots using any outdated database do so entirely at their own risk.



WARNING: Do not use data link weather information for maneuvering in, near, or around areas of hazardous weather. Information contained within data link weather products may not accurately depict current weather conditions.



WARNING: Do not use the indicated data link weather product age to determine the age of the weather information shown by the data link weather product. Due to time delays inherent in gathering and processing weather data for data link transmission, the weather information shown by the data link weather product may be significantly older than the indicated weather product age.



WARNING: The data contained in the terrain and obstacle databases comes from government agencies. Garmin accurately processes and cross-validates the data, but cannot guarantee the accuracy and completeness of the data.



WARNING: The illustrations in this guide are only examples. Never use the G3X Touch to attempt to penetrate a thunderstorm. Both the FAA Advisory Circular, Subject: Thunderstorms, and the Aeronautical Information Manual (AIM) recommend avoiding "by at least 20 miles any thunderstorm identified as severe or giving an intense radar echo."



WARNING: Because of variation in the earth's magnetic field, operating the G3X Touch within the following areas could result in loss of reliable heading indications. North of 72° North latitude at all longitudes; South of 70° South latitude at all longitudes; North of 65° North latitude between longitude 75° W and 120° W. (Northern Canada); North of 70° North latitude between longitude 70° W and 128° W. (Northern Canada); North of 70° North latitude between longitude 85° E and 114° E. (Northern Russia); South of 55° South latitude between longitude 120° E and 165° E. (Region south of Australia and New Zealand)



WARNING: The United States government operates the Global Positioning System and is solely responsible for its accuracy and maintenance. The GPS system is subject to changes which could affect the accuracy and performance of all GPS equipment. Portions of the Garmin G3X Touch utilize GPS as a precision electronic NAVigation AID (NAVAID). Therefore, as with all NAVAIDs, information presented by the G3X Touch can be misused or misinterpreted and, therefore, become unsafe.



WARNING: Do not use basemap (land and water data) information for primary navigation. Basemap data is intended only to supplement other approved navigation data sources and should be considered as an aid to enhance situational awareness.



WARNING: Do not use the approach information provided by the VFR navigation database residing within the G3X Touch as a means of navigating any instrument approach. The G3X Touch VFR navigation database is limited to present only the waypoints for the final approach leg of a published procedure. These waypoints and associated course line are made available for monitoring purposes only.



WARNING: Do not rely solely upon the display of traffic information for collision avoidance maneuvering. The traffic display does not provide collision avoidance resolution advisories and does not under any circumstances or conditions relieve the pilot's responsibility to see and avoid other aircraft.



WARNING: Do not rely solely upon the display of traffic information to accurately depict all of the traffic within range of the aircraft. Due to lack of equipment, poor signal reception, and/or inaccurate information from aircraft or ground stations, traffic may be present that is not represented on the display.



WARNING: Do not rely solely upon the fuel quantity indications or calculated fuel quantity. It is the responsibility of the pilot to perform proper flight planning and verify that indicated fuel quantity values are accurate prior to each flight.



WARNING: For safety reasons, G3X Touch operational procedures must be learned on the ground.



CAUTION: The display uses a lens with a special coating that may be sensitive to abrasive cleaners, etc. **CLEANERS CONTAINING AMMONIA OR SOLVENTS MAY HARM THIS COATING.** It is very important to clean the lens using a clean, lint-free cloth (such as the Garmin cleaning cloth). Avoid any chemical cleaners or solvents that can damage plastic components.



CAUTION: *The Garmin G3X Touch does not contain any user-serviceable parts. Repairs should only be made by an authorized Garmin service center. Unauthorized repairs or modifications could void both the warranty and the pilot's authority to operate this device under FAA/FCC regulations.*



NOTE: *The Garmin G3X Touch has a very high degree of functional integrity. However, the pilot must recognize that providing monitoring and/or self-test capability for all conceivable system failures is not practical. Although unlikely, it may be possible for erroneous operation to occur without a fault indication shown by the G3X Touch. It is thus the responsibility of the pilot to detect such an occurrence by means of cross-checking with all redundant or correlated information available in the cockpit.*



NOTE: *All visual depictions contained within this document, including screen images of the G3X Touch panel and displays, are subject to change and may not reflect the most current G3X Touch system and aviation databases. Depictions of equipment may differ slightly from the actual equipment.*



NOTE: *This product, its packaging, and its components contain chemicals known to the State of California to cause cancer, birth defects, or reproductive harm. This notice is being provided in accordance with California's Proposition 65. If you have any questions or would like additional information, please refer to our web site at www.garmin.com/prop65.*



NOTE: *Interference from GPS repeaters operating inside nearby hangars can cause an intermittent loss of attitude and heading displays while the aircraft is on the ground. Moving the aircraft more than 100 yards away from the source of the interference should alleviate the condition.*



NOTE: *Use of polarized eyewear may cause the flight displays to appear dim or blank.*



NOTE: *Temporary Flight Restriction (TFR) data is provided by the FAA and may not be updated outside of normal business hours. Confirm data currency through alternate sources and contact your local FSS for interpretation of TFR data.*



NOTE: Unless otherwise specified, all screen images contained within this document are taken from the GDU™ 460 display. The GDU 470 screen images will vary slightly from the GDU 460.



NOTE: The GDU 4XX automatically logs flight data including, but not limited to, primary flight data, engine parameters, and system status information. This data can be downloaded to an SD card, when the aircraft is on the ground. The downloaded data can be viewed using common computer software. It is not possible to disable the logging of this data or to manually delete logged data. Logged data will be stored only on the GDU 4XX and will not be transmitted or transferred to Garmin or to any other third party, with the exception of government agencies investigating an accident or incident involving your aircraft and/or the parties to any resulting legal proceedings that may be related to the aircraft accident or incident.



NOTE: The Bluetooth® word mark and logos are registered trademarks owned by Bluetooth SIG, Inc. and any use of such marks by Garmin is under license.

1. FCC

011-03519-00, 011-03784-00, and 011-03784-10 contain FCC ID: QOQWT32I

011-03519-01, 011-03784-01, and 011-03784-11 contain FCC ID: 2ADHKBM83SM1

NOTE

The GMA 245 and GMA 245R complies with Part 15 of the FCC Rules. Operation is subject to the following two conditions: (1) this device may not cause harmful interference, and (2) this device must accept any interference received, including interference that may cause undesired operation.

2. IC

011-03519-00, 011-03784-00, and 011-03784-10 contain IC: 5123A-BGTWT32I

011-03519-01, 011-03784-01, and 011-03784-11 contain IC: 20266-BM83SM1

NOTE

This device complies with Industry Canada license-exempt RSS standard(s). Operation is subject to the following two conditions: (1) this device may not cause interference, and (2) this device must accept any interference, including interference that may cause undesired operation of the device.

Cet appareil est conforme aux normes RSS sans licence d'Industrie Canada. Son fonctionnement est soumis aux conditions suivantes : (1) cet appareil ne doit pas causer d'interférences et (2) doit accepter toute interférence, y compris les interférences pouvant entraîner un fonctionnement indésirable de l'appareil.

RF Radiation Exposure Statement:

This equipment complies with FCC radiation exposure limits set forth for an uncontrolled environment. End users must follow the specific operating instructions for satisfying RF exposure compliance. This transmitter meets both portable and mobile limits as demonstrated in the RF Exposure Analysis. This transmitter must not be co-located or operating in conjunction with any other antenna or transmitter except in accordance with FCC multi-transmitter product procedures.

Énoncé sur l'exposition aux rayonnements RF

Cet appareil est conforme à la réglementation FCC relative aux limites d'exposition aux radiations applicables en environnement non contrôlé. L'utilisateur doit suivre les directives d'opération spécifique à la conformité sur l'évitement de l'exposition aux rayonnements RF. Cet émetteur répond aux limites d'émission pour les appareils portables et mobiles, comme démontré dans l'analyse d'exposition RF. Cet émetteur ne doit pas être placé ou utilisé en conjonction avec d'autres antennes ou émetteurs, sauf en conformité aux procédures de produits multiémetteurs de la FCC.

Anatel Warning (GMA 245R)

Este equipamento não tem direito à proteção contra interferência prejudicial e não pode causar interferência em sistemas devidamente autorizados.

Blank Page

Part Number	Change Summary
190-02472-00	Initial release

Rev	Date	Description
A	March, 2019	Production Release
B	December, 2019	<p>Updated for software version 8.60</p> <p>Added remote COM control (GTR 20)</p> <p>Added remote audio control (GMA 245R)</p> <p>Added Marker Beacon display</p> <p>Added standalone MFD and EIS support</p> <p>Added Angle of Attack (AOA) display and alerting</p> <p>Added Carbon Monoxide Detector display and alerting</p> <p>Added Main Menu LRU controls (COM, Audio Panel, and XPDR)</p> <p>Updated terrain options menu</p> <p>Added flight plan information to the Map/Charts pages</p> <p>Added access to the autopilot interface from the Main Menu</p> <p>Added Connex Flight Data Logging</p> <p>Added Automatic Sharing of G3X Touch Flight Plans with External IFR Navigators</p> <p>Added GTR 200B functionality</p> <p>Added comparison alerts</p> <p>Added importing/exporting user waypoints</p> <p>Updated NAV find procedure</p> <p>Updates to support GTX integration with TAS/TCAS</p> <p>Added note regarding VNAV mode</p> <p>Added note about Glide Range Ring requiring OAT</p> <p>Updated PFD wind speed/direction to a toggle button also displaying headwind/crosswind components</p> <p>Added Weight & Balance envelope as Moment vs Weight</p> <p>Added GPS Steering (GPSS) for non-Garmin autopilots</p>

Rev	Date/	Description
C	December, 2021	Updates to support GTX integration with TAS/TCAS Updated Transponder Mode Selection Updated ILS Auto Switching procedure to specify type of equipment needed Added 'ECS FAIL' CAS message Added Fuel Flow Calibration Updated color active COM frequencies are displayed in when no audio panel is configured Added Center Weather Advisory FIS-B weather product Added Graphical AIRMET FIS-B weather product Updated Flight Director Lateral Modes table Updated Baro Sync procedure Added NOTE regarding formatting an SD Card using Mac OS Updated backcourse (BC) navigation mode information Added GAD 29D Updated System Settings section Updated Comparison Alerts Added LP+V Updated Weather Product Timing table Added Emergency Page Added Smart Glide emergency operations Updated EIS display Updated dual cue command bars Updated glide range ring information
D	January, 2022	Updated System Status Messages Added TOD/BOD note regarding GTN Xi Added Fuel Flow Calibration note
E	February, 2023	Updated before takeoff checklist Removed restriction that an approach must be armed after the TOD Added paper mark Other miscellaneous updates

Rev	Date/	Description
F	April, 2023	Updated 'Accessing the Emergency Page' Updated Status Alerts table Updated CAS messages Updated 'AHRS IGRF data out of date' message Updated ESP information Updated Traffic Page callouts Updated Angle of Attack information Updated Fuel Tank Reminder Alarm information Added GDL 5XR note Added QFE altimeter NOTE Updated barometric sync with GI 275 Removed TRK/HDG Added NAV Annunciations, NAV Window, and NAV Error Messages Added note about formation flight Added "Vertical Track" Voice Alert Added GI 275 comparison annunciation note Updated Glide Range Ring information Added VDI preview Updated GMA 245/245R compliance information

Blank Page

Section 1 System Overview	1
1.1 Line Replaceable Units	1
G3X Touch System	8
External Navigators (Optional)	12
ADS-B Devices (Optional)	13
Automatic Flight Control System	14
1.2 Display Overview	14
1.3 Secure Digital (SD) Cards	16
1.4 System Initialization	16
1.5 System Operation	17
Split Mode	17
PFD/MFD Display Configuration	19
AHRS Operation	23
1.6 Accessing System Functionality	25
Menus	25
Data Entry	25
Pages	27
1.7 Accessing Additional Information	29
Viewing GPS Receiver Status	30
Position	32
1.8 System Settings	33
Transponder	34
Data Bar Setup	34
General Display information	36
Display setup	37
Units Setup	42
Time Setup	42
Map Setup	43
Position Setup	43
Alarms Setup	43
Airspace Setup	45
Bluetooth Setup	45
PFD Setup	45
Navigation Setup	45
Keyboard Setup	46
Section 2 Flight Instruments	47
2.1 Flight Instruments	47
Attitude Indicator	52
Altimeter	54
Vertical Speed Indicator (VSI)	59
Vertical Deviation Indicator and VNAV Indicator	60

Horizontal Situation Indicator (HSI)	63
Turn Rate Indicator	73
OBS Mode	74
VDI Preview	76
2.2 Supplemental Flight Data	76
Outside Air Temperature	77
Wind Data	78
User Timer	78
Angle of Attack (AOA)	79
2.3 Vertical Navigation (VNAV)	80
Using the VNAV Feature	82
VNAV Paired With GTN	84
Section 3 Engine Indication System	87
3.1 EIS Display & ENG Page	87
3.2 Lean Assist Mode (Optional)	90
3.3 Fuel Calculator (Optional)	94
3.4 Fuel Flow Calibration	95
3.5 CAS Messages	96
Section 4 CNS Interface (Optional)	97
4.1 CNS Data Bar	97
4.2 COM Annunciations	98
4.3 COM Window	98
COM Frequency Finding	100
Automatic Squelch	101
4.4 COM Error Messages	101
4.5 Nav Annunciations	102
4.6 Nav Window	102
NAV Frequency Finding	103
4.7 Nav Error Messages	104
4.8 Auto-Tuning Frequencies	104
4.9 User Frequencies	106
4.10 Audio Panel	107
Audio/Intercom Page	109
Radios Tab	109
Intercom Tab	114
Phone & Media Tab	117
Music Input Tab	127
4.11 Remote Transponder Interface (Optional)	129
Transponder CODE and Mode Selection	130
ADS-B Out	133

Flight ID Reporting	133
Additional Transponder Messages	134
Section 5 GPS Navigation	135
5.1 Introduction	135
Compass Arc	135
5.2 Using Map Displays	136
Map Page Setup	137
Map Range	141
Map Panning	141
Fuel Range Ring	143
Glide Range Ring	144
Best Airport Bearing Pointer	144
Best Airport Line	146
Selected Altitude Intercept Arc	147
Measuring Bearing and Distance	147
Topography	148
Map Page Traffic	148
Map Symbols	149
5.3 Airways	150
5.4 Waypoints	152
Automatic Waypoint Selection	155
Nearest Information	155
Weather Information	157
Intersections	157
NDBs	158
VORs	159
User Waypoints	159
5.5 Airspace	162
Airspace Alert Messages	162
Smart Airspace™ and Altitude Overlays	163
5.6 Direct-to Navigation Using the G3X Touch	164
Section 6 Flight Planning	167
6.1 Introduction	167
Flight Plan Data Fields	168
Manually Switching Between Internal and External Flight Plan Sources	168
Failure of the External GPS Navigation Source	168
6.2 Flight Plan Creation Using the G3X Touch	169
6.3 Automatic Sharing of G3X Touch Flight Plans with External IFR Navigators ..	171
External IFR Navigator Crossfill Configuration (GPS 175, GNC® 355, GNX 375™, and GTN™ 6XX/7XX (version 6.6.2 and newer only))	172

6.4 Flight Plan Storage Using the G3X Touch	173
6.5 Flight Plan Activation Using the G3X Touch	174
6.6 Flight Plan Editing	175
Adding Waypoints to an Existing Flight Plan	175
Editing Flight Plan Speed, Fuel, and/or Name	176
Copying Flight Plans	178
Deleting Flight Plans	178
Inverting a Flight Plan	180
Importing/Exporting Flight Plans	180
Sending Flight Plans to a GNS/GTN	181
6.7 Approaches (Without External Navigator Configured)	182
Selecting an Approach	183
Activating Vectors-to-Final	185
Section 7 Hazard Avoidance	187
7.1 Weather Information	187
Weather Sources	187
Data Link Weather (Optional)	188
7.2 Terrain	216
Synthetic Vision	217
Terrain Information	217
Terrain Views	218
Terrain Settings	219
Terrain Alerts	220
7.3 Traffic Systems	222
Traffic Source	222
Traffic Prioritization	224
Traffic Information Service (TIS-A) (Optional)	224
Garmin GTS 8XX Traffic (Optional)	230
Data Link Traffic (Optional)	237
Section 8 Additional Features	249
8.1 Synthetic Vision (SVX)	250
Synthetic Vision Operation	252
8.2 SafeTaxi®	263
SafeTaxi Cycle Number and Revision	264
8.3 ChartView	264
Aircraft Symbol	266
Chart Range	266
Navigation Database-published NOTAMS	267
8.4 FliteCharts®	268
Aircraft Symbol	271
Chart Range	271

FliteCharts Cycle Number and Expiration Date	271
8.5 Airport Directory Data	271
8.6 SIRIUSXM Radio Entertainment (Optional)	273
Activating SiriusXM Satellite Radio Services	273
Using SIRIUSXM Radio	274
8.7 Electronic Checklists (Optional)	275
8.8 Flight Data Logging Using the SD Card	276
8.9 Connex Cockpit Connectivity	276
Pairing the G3X Touch with a Bluetooth Device	278
Transferring a Flight Plan	279
Flight Data Logging in Garmin Pilot	280
8.10 Electronic Stability & Protection (ESP-X)	284
Roll Engagement	286
Pitch Engagement	288
Airspeed Protection	289
8.11 Carbon Monoxide (CO) Detector (Optional)	290
Section 9 Automatic Flight Control Systems (Optional)	291
AFCS System Architecture	291
G3X Touch AFCS Status Box	293
9.1 AFCS Operation	294
AFCS PRE-FLIGHT Actions	295
AFCS Controls	296
Flight Director Operation	301
9.2 Vertical Modes	305
Pitch Hold Mode (PIT)	307
Selected Altitude Capture Mode (ALTS)	308
Vertical Speed Mode (VS)	310
Indicated Airspeed Mode (IAS)	311
Vertical Navigation Mode (VNAV)	312
VNAV Target Altitude Capture Mode (ALTV)	314
Glideslope Mode (GP) (with external WAAS enabled IFR navigator ONLY)	315
Glideslope Mode (GS)	316
Go Around (GA) and Takeoff (TO) Modes	317
9.3 Lateral Modes	317
Roll Hold Mode (ROL)	319
Heading Select Mode (HDG)	319
Track Select Mode (TRK)	320
Navigation Modes (GPS, VOR, LOC, BC)	321
Approaches without Vertical Guidance	325
Approaches with Lateral + Vertical Guidance	329
9.4 Non-Garmin Autopilots	332
GPS Steering (GPSS)	333

Section 10 Annunciations & Alerts	335
10.1 Miscellaneous Message Advisories	335
10.2 Airspace Messages	336
10.3 System Status Messages	337
System Status Messages.....	338
10.4 Audio Alerts	342
Voice Alerts.....	342
AOA Aural Alert.....	342
10.5 PFD Annunciations and Alerting Functions	343
Marker Beacon Annunciation.....	343
CAS Messages.....	344
Terrain Annunciations.....	345
Traffic Annunciations.....	345
AHRS Alerts (Optional).....	346
AFCS Alerts (Optional).....	348
Section 11 Appendices	351
Appendix A: Data Field Options	351
Appendix B: Utilities	359
Flight Log.....	359
Track log.....	362
Track Vector.....	366
Weight & Balance.....	368
Proximity Waypoints and Alarms.....	372
Appendix C: SD Card Use and Databases	375
Installing and Removing SD Cards.....	376
G3X Touch Databases.....	376
Updating G3X Touch Databases.....	380
Importing/Exporting Flight Plans To/From the SD Card.....	384
Flight Data Logging.....	384
Appendix D: Map Datum and Location Formats	385
Map Datums.....	385
Location Formats.....	385
Appendix E: General TIS-A Information	387
TIS-A vs. TAS/TCAS.....	387
TIS-A Limitations.....	388
Appendix F: Abnormal Operation	391
Loss of GPS Position.....	391
Hazard Display with Loss of GPS Position.....	391
G3X Touch System Failure Annunciations.....	392
Unusual Attitudes.....	392

Reversionary Mode (Full-Screen).....	393
AFCS Reversionary Mode.....	394
Failure of the External GPS Navigation Source.....	394
Synthetic Vision Troubleshooting.....	394
Emergency Page.....	395
Smart Glide™ Emergency Operations.....	396
Appendix G: Display Symbols	405
VFR Symbols.....	405
IFR Symbols.....	406
Airspace Symbols.....	408
Appendix H: Glossary	411
Appendix I: License Agreement and Warranty	417
Contact Garmin.....	417
Software License Agreement.....	417
Limited Warranty for G3X Touch Products.....	417
AOPA Airport Directory Notice.....	418
AC-U-KWIK LICENSE AGREEMENT.....	419
SIRIUSXM Satellite Radio Service Agreement.....	419
Weather Data Warranty.....	419
Index	Index-1

Blank Page

SECTION 1 SYSTEM OVERVIEW

1.1 LINE REPLACEABLE UNITS

The G3X Touch™ system may consist of the following Line Replaceable Units (LRUs):

- **Garmin Display Unit (GDU™) 460**

- Single Display: Split Primary Flight Display (PFD) & Multi Function Display (MFD), standalone Multi Function Display (MFD)
- Multiple Displays: PFD, MFD, or split-screen
- Landscape orientation



GDU 460 (10.6 inch)
(Landscape Orientation)

- **GDU 470**

- Single Display: Split Primary Flight Display (PFD) & Multi Function Display (MFD), standalone Multi Function Display (MFD)
- Multiple Displays: MFD, PFD, or split-screen
- Portrait Orientation



GDU 470 (7 inch) (Portrait Orientation)

- **GSU 25D**

- Garmin Sensor Unit sub-system for the G3X Touch (Air Data Computer (ADC), and the Attitude and Heading Reference System (AHRS))
 - ADC: Processes data from the pitot-static system and outside air temperature (OAT) sensor.
 - AHRS: Provides aircraft attitude and heading information to the PFD. The AHRS contains advanced sensors (including accelerometers and rate sensors) and interfaces with the magnetometer to obtain magnetic field information, with the ADC to obtain air data, and with the GDU to obtain GPS information. AHRS operation is discussed later in this section.



GSU 25D

- **GMU 11**

- Magnetometer: Measures the local magnetic field and sends data to the AHRS for processing to determine aircraft magnetic heading.



GMU 11

- **GTP 59**

- Temperature Probe: Provides raw air temperature data.



GTP 59

- **GAP 26**

- AOA Probe: Sends dynamic air pressure for angle of attack (AOA), when paired with a GSU 25.

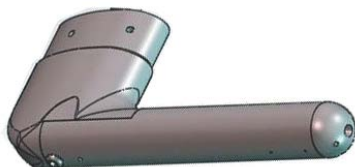

GAP 26

- **GSA 28**

- Auto Pilot Servo: Used for automatic control of pitch, roll, yaw, and trim.



GSA 28

- **GEA 24**

- Engine and Airframe Unit: Receives and processes signals from the engine and airframe sensors.



GEA 24

• GAD 27

- Provides a power source to keep essential avionics online during engine start (14V airframes only).
- Supports wig-wag function where the landing and taxi lights are flashed in an alternating fashion (14V and 28 V airframes).



GAD 27

• GAD 29B/29D

- ARINC 429 interface: Transmits and receives ARINC 429 signals for interface to panel-mount IFR GPS navigators.



GAD 29B

- System Overview
- Flight Instruments
- EIS
- CNS Interface
- GPS Navigation
- Flight Planning
- Hazard Avoidance
- Additional Features
- AFCS
- Annun/Alerts
- Appendix
- Index

• GMC 507 (AFCS Mode Controller)

- Automatic Flight Control System (AFCS) Mode Controller. The GMC 507 provides a user interface for the autopilot and flight director function of the G3X system.



GMC 507

• GTR 20 (VHF Communications Radio)

- A remote-mounted VHF COM transceiver that operates in the 118.000 to 136.975 MHz frequency range with a 25 kHz channel spacing. The GTR 20 features a built-in two-place stereo intercom with alert audio, 3D audio, and stereo music inputs.
- Fully controlled by G3X Touch displays.

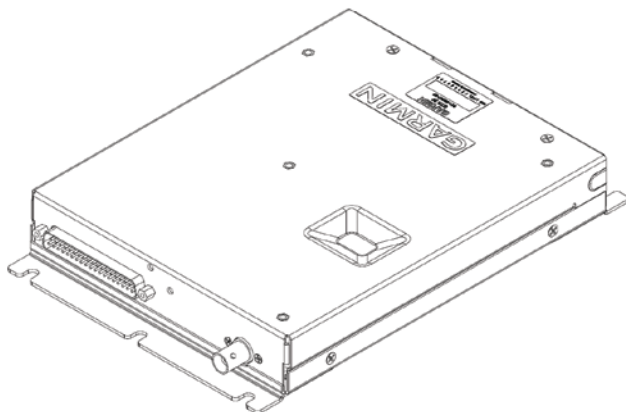

GTR 20

• GTR 200B (VHF Communications Radio)

- A panel-mounted VHF COM transceiver that operates in the 118.000 to 136.975 MHz frequency range with a 25 kHz channel spacing. The GTR 200B features a built-in two-place stereo intercom with alert audio, 3D audio, Bluetooth, and stereo music inputs.
- For detailed operating information, reference the GTR 200/200B Pilot's Guide p/n 190-01553-01.



GTR 200B

• GMA 245R

- A remote mounted digital audio panel with stereo intercom system (ICS), 3D audio and Bluetooth capability.
- Provides the traditional audio selector functions of microphone, receiver audio selection, and speaker output, with interfaces to dual NAV/COM radios and Marker Beacon.
- Fully controlled by G3X Touch displays.



GMA 245R

- **GDL[®] 5XR**
 - GDL 50R: ADS-B receiver
 - GDL 51R: SXM receiver
 - GDL 52R: ADS-B/SXM combination receiver



GDL 50R



NOTE: Approved software for PMA GDL 5XR units can only be loaded via the G3X GDU (reference 'Software Loading Procedure' in G3X Touch EFIS STC Maintenance Manual). The ability to update GDL 5XR software via Bluetooth is disabled for PMA GDL 5XR units.

G3X TOUCH SYSTEM

The G3X Touch System can be configured as follows:

- Standalone MFD with optional EIS. NOTE: Remote annunciator 'Engine' lights are required when a standalone MFD with EIS is installed outside of the pilot's primary field of view.
- One GDU 470 (7" portrait) display unit (provides both PFD and MFD)
- One GDU 460 (10" landscape) display unit (provides both PFD and MFD)
- Two GDU 470 (7" portrait) display units (one configured as PFD and one as MFD)
- One GDU 460 (10" landscape) display unit and one GDU 470 (7" portrait) display unit

- Additional GDU's may be installed for the copilot on the right side of the panel in a side-by-side cockpit or the second cockpit of a tandem aircraft. Copilot GDU's can display a backup PFD using the same ADAHRS data as the pilot's PFD.



GDU 470 (standalone MFD, optional EIS)



GDU 470 (split-screen PFD/MFD, no EIS)

- System Overview
- Flight Instruments
- EIS
- CNS Interface
- GPS Navigation
- Flight Planning
- Hazard Avoidance
- Additional Features
- AFCs
- Annun/Alerts
- Appendix
- Index



GDU 460 (split-screen PFD/MFD, EIS optional)



Dual GDU 470s (PFD & MFD, EIS optional)



GDU 460 and GDU 470 (PFD & MFD, EIS optional)

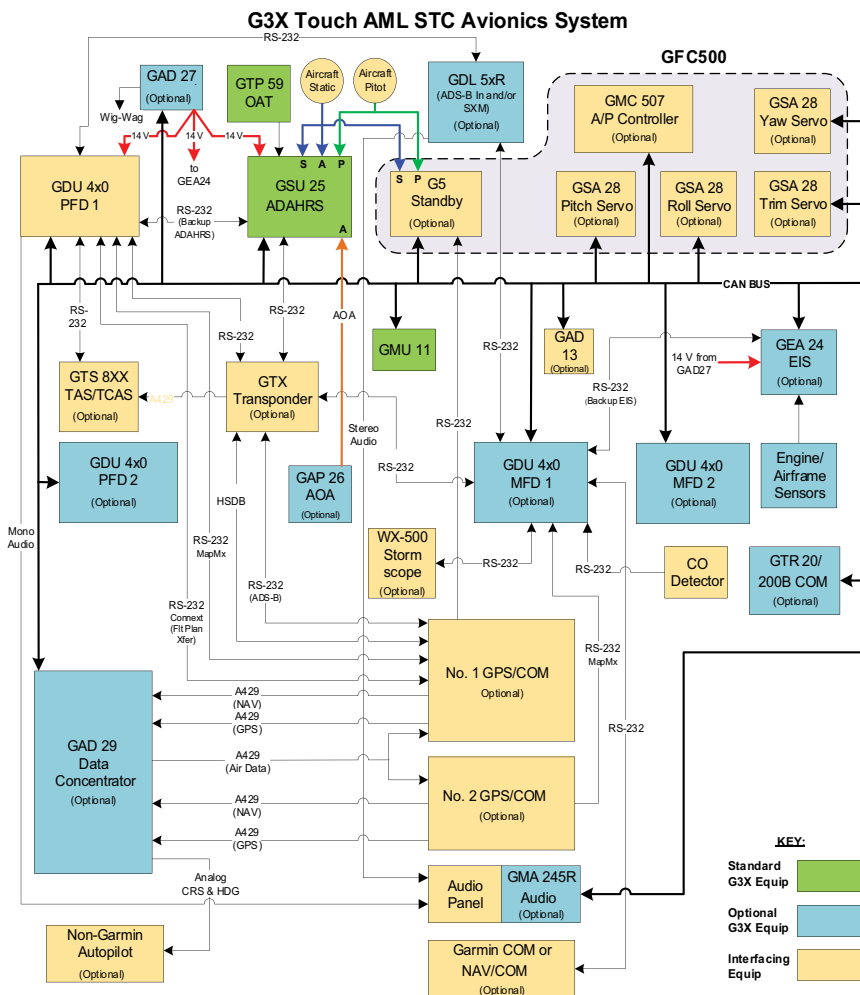

System Overview

Flight Instruments

EIS

CNS Interface

GPS Navigation

Flight Planning

Hazard Avoidance

Additional Features

AFCS

Annun/Alerts

Appendix

Index

EXTERNAL NAVIGATORS (OPTIONAL)

The G3X Touch can also communicate with the following optional external navigators:

- SL30 Nav/Comm Transceiver
- GNC[®] series Nav/Comm Transceiver
- GTN[™] or GNS Series Units
- GPS 175
- GNX[™] 375

USING THE G3X TOUCH WITH AN EXTERNAL GPS NAVIGATOR



WARNING: Do not use the approach information provided by the VFR navigation database residing within the G3X Touch as a means of navigating any instrument approach. The G3X Touch VFR navigation database is limited to present only the waypoints for the final approach leg of a published procedure. These waypoints and associated course line are made available for monitoring purposes only.

In a configuration which includes one or more external GPS navigators (i.e., GTN or GNS Series), the G3X Touch displays the selected external GPS Navigator's flight plan and guidance information.

When an external navigator is configured the internal GPS can still be used for VFR navigation. When using an external GPS navigator with the G3X Touch, touch **FPL Source** > **Internal** to switch to the internal GPS navigation. Touch **FPL Source** > **External** to return to the external GPS navigation.



NOTE: The G3X Touch internal GPS flight plan is only for VFR use.

CHANGING THE NAVIGATION SOURCE

When an external navigator that supports both GPS and VOR/ILS capabilities (i.e., GTN or GNS Series) is selected, the external navigator's **CDI** Key is used to switch the G3X Touch HSI between GPS and VOR/ILS navigation.

SELECTION BETWEEN MULTIPLE NAVIGATORS



NOTE: On a standalone MFD, touch 'GPS' in the lower left corner of the display to switch between 'Internal' and 'External' navigation sources.

The G3X Touch **CDI Source** button in the PFD Options Window becomes available when more than one source of navigation data is configured. The **CDI Source** button toggles between the available navigation sources (e.g., between the internal G3X Touch GPS and external SL30 VLOC sources, between an SL30 and a GNS 430, or between two GNS 430s, etc.). Refer to the Flight Instruments section for more information.

USING MAPMX SERIAL DATA INPUT FORMAT

When using a WAAS enabled external GPS navigator (i.e., GNS 430W/530W, GNS 480 or any GTN Series navigator), and configuring an RS-232 input for 'MapMX' instead of 'Aviation In', a more accurate depiction of the flight plan legs are displayed on the moving map (i.e., holds, procedure turns, etc.). Non-WAAS external navigators do not support MapMX. Refer to the G3X Touch Installation Manual for more information.

EXTERNAL GPS NAVIGATOR FAILURE

In the event that all configured external GPS navigators fail, the G3X Touch reverts to its internal VFR GPS for navigation and flight plan modifications.

ADS-B DEVICES (OPTIONAL)

The G3X Touch is also compatible with the following ADS-B devices:

- GDL 50R
- GDL 52R
- GTX 345(R)
- GNX 375

AUTOMATIC FLIGHT CONTROL SYSTEM

The G3X Touch can also communicate with the Garmin GFC 500. With the AFCS configured, the G3X Touch issues pitch and roll steering commands to the autopilot. Refer to Section 9 (AFCS) for more information.

1.2 DISPLAY OVERVIEW



Left Knob Nearest Button Direct-to Button SD Card Slot Menu Button Back Button Right Knob

Bezel Overview (GDU 460)



Bezel Overview (GDU 470)

- NRST Key** Press to display the Nearest Page for viewing the nearest airports, intersections, NDBs, VORs, waypoints, frequencies, and airspaces
- Direct-To Key** Press to activate the Direct-To function, enter a destination waypoint and establish a direct-to course to the selected destination
- MENU Key** Press once to view the Page Menu
 Press twice to view the Main Menu
 Press a third time to clear the Main Menu
 Press and hold to save a screenshot to the SD Card (if screenshot functionality is enabled)
- BACK Key** Press to return to the previous screen
 Press and hold to return to the default MFD Page
 Press and hold to toggle between full-screen and split-screen modes (When configured, display layout can be toggled with a BACK key press (no hold))

- System Overview
- Flight Instruments
- EIS
- CNS Interface
- GPS Navigation
- Flight Planning
- Hazard Avoidance
- Additional Features
- AFCS
- Annun/Alerts
- Appendix
- Index

1.3 SECURE DIGITAL (SD) CARDS



NOTE: Refer to Appendix C for more information on SD Card use and databases.

The G3X Touch data card slot uses Secure Digital (SD) cards. The SD card can be used for software updates, checklist files, flight data logging, exporting Track Logs/User Waypoints, and Importing/Exporting Flight Plans.

Installing an SD Card:

- 1) Insert the SD card in the SD card slot with the card contacts facing down (or facing right on the GDU 470). The card should be flush with the face of the bezel.
- 2) To eject the card, gently press on the SD card to release the spring latch.

1.4 SYSTEM INITIALIZATION

During system initialization, the AHRS displays the message 'AHRS ALIGN' over the attitude indicator. The AHRS should display valid attitude and heading fields typically within the first minute of starting the system. The AHRS can align itself both while taxiing and during level flight.



AHRS Align Message

The data link weather advisory and current database information are displayed when starting the system including valid operating dates, cycle number, and database type. When this information has been reviewed for currency (to ensure that no databases have expired), the pilot is prompted to continue.



Database Information

Touch **Continue** to acknowledge the information.

1.5 SYSTEM OPERATION



NOTE: Refer to the *G3X Touch Installation Manual* for information on configuring the displays.

SPLIT MODE

Press **Split** or **Full** in the upper left or right hand corner of the display to toggle between split and full screen.

Or:

Press and hold the **BACK** Key to toggle between split and full screen. (When configured, display layout can be toggled with a BACK key press (no hold))

- System Overview
- Flight Instruments
- EIS
- CNS Interface
- GPS Navigation
- Flight Planning
- Hazard Avoidance
- Additional Features
- AFCs
- Annun/Alerts
- Appendix
- Index

Touch To Access The Engine Page



Split Mode - GDU 460

Touch To Swap SPLIT and FULL Mode



Split Mode - GDU 470

PFD/MFD DISPLAY CONFIGURATION

Changing the PFD/MFD Startup Page:

- 1) Press the **MENU** Key twice to display the Main Menu.
- 2) Touch **Setup > Display**.
- 3) In the PFD/MFD Startup Page field, touch 'Auto' (selecting 'Auto' allows selection of 'Auto', 'Map', 'Charts', 'Active FPL', 'Weather', 'Terrain', or 'Info') or 'Split'.



NOTE: MFD's are configured during installation to only allow 'Auto' selections. The 'Split' selection is not allowed as the default MFD Startup Page. The pilot must manually select the 'Split' touchscreen button in the upper corner of the display after each power cycle.

Changing the PFD/MFD Split-Screen Side (GDU 460 only):

- 1) Press the **MENU** Key twice to display the Main Menu.
- 2) Touch **Setup > Display**.
- 3) In the PFD/MFD Split Screen Side field, touch 'Left' or 'Right'.

PFD OPTIONS

Pressing the **MENU** Key while the PFD is in Full screen mode or pressing on the HSI in any screen mode displays options for several navigation tools. While the PFD Options menu is open, pressing the **MENU** Key again will open the Main Menu. The PFD Options menu also has a **More Options...** button to enter PFD Setup to customize the PFD itself.

INSET WINDOWS

Each Inset Window can be configured to display one of a variety of information alongside the PFD. Inset Windows are available on the GDU 460 display unit.

Map	Touch the magnification buttons to zoom in or out of the map. Touch anywhere else to show the split-screen map.
Traffic	Touch the magnification buttons to zoom in or out of the map. Touch anywhere else to show the split-screen traffic display.
Flight Plan	Touch and drag to scroll through the flight plan. Touch to show the split-screen flight plan display.
Nearest Airports	Touch and drag to scroll through the list of nearest airports. Touch to select a nearest airport.
G Meter	Touch to reset the G Meter to zero.

BEARING POINTERS

Two Bearing Pointers for the HSI can be enabled or disabled in the PFD Options menu. Touch  to set each Bearing Pointer to **Off**, **GPS**, **VLOC (1/2)** (when configured), **Best Airport** (when configured), or **Nearest Airport**. Each Bearing Pointer is accompanied by an info box below the HSI indicating its target.

While the G3X Touch has an active flight plan, setting a Bearing Pointer to **GPS** will indicate the heading of the next waypoint on the active flight plan. Without an active flight plan, setting a Bearing Pointer to **GPS** will not display a Bearing Pointer.

TIMER

A simple timer for measuring arbitrary periods of time, separately from the Flight Timer. Tap **Start** to start the Timer. While the Timer is running, the Start button becomes a **Stop** button which pauses the Timer. **Reset** will set the Timer to zero and stop the Timer. The Timer is visible at the left-center of the status bar at the bottom of the screen, labeled as 'TMR'. The Timer can also be configured to display in the Data Bar. Pressing the **Back** Key to close the PFD Options menu will not interrupt the Timer.

MINIMUMS

The Minimums option sets a minimum barometric altitude. If the G3X Touch detects the aircraft descending to this altitude, the Minimums Alert will sound and the text on the minimums button is displayed in amber.

GDU 460 KNOB OPERATION

The display unit knobs are highly customizable and can be configured for a variety of functions, especially for PFD functions. The two options that configure the PFD knobs are found in the PFD Setup menu. On the PFD display unit, press the **MENU** button and touch the **More Options...** on-screen button.

The "main" PFD knobs are by default on the left-hand side of the display, and "alternate" knobs on the right. This can be changed by pressing the **MENU** key twice and touching the **PFD** icon, then changing **PFD Split Screen Side** from Right to Left.

By default the main inner knob will adjust the HSI's heading bug, and the main outer knob will adjust the altitude bug. The alternate inner knob will adjust the HSI course selection (in OBS mode) or the VLOC course, depending on the current CDI source. The alternate outer knob will adjust the local barometric pressure setting.

The functionality of the alternate knobs can be changed through the **Right Side Knob Action** option in the PFD Setup menu. Note that this setting's name can change to **Left Side Knob Action** if the split screen is set to Left instead of the default Right.

The other settings available for the alternate knobs are **FD Bug/Baro** and **Heading/Altitude**. FD Bug/Baro will set the alternate inner knob to adjust the Flight Director bug if the Flight Director is active, and outer knob for local barometric pressure. Setting the alternate knobs to Heading/Altitude will mirror the functions of the main knobs.

Additionally, the option to **Press To Toggle Knob Action** is available to get more functionality out of the PFD knobs. When enabled, pressing either inner knob will change the knobs between main knob functions and alternate knob functions. This feature is intended for cockpits that frequently use Split Screen features, since the split screen will reserve a knob for MFD functions. "Main" functions will always be Heading/Altitude, and "alternate" functions will be specified in the Right Side Knob Action setting (also known as Left Side Knob Action).

GDU 470 KNOB OPERATION

The GDU 470 has a single knob which is used for the PFD when in full-screen PFD mode, and is used for the MFD for all other display modes. For the full-screen PFD, the "Press To Toggle Knob Action" setting is always enabled (in order to always have access to the Baro setting via the knob), and the "Toggle Knob Action" setting provides the same knob action selections as the GDU 460 (Course/Baro, FD Bug/Baro, or Heading/Altitude).

MORE OPTIONS...

Touching **More Options...** opens the PFD Setup menu that allows customization of PFD appearance and functionality. Changing both PFD Presentation and Attitude Presentation to Round Gauges will configure the PFD to resemble a "six-pack" style panel of mechanical gauges.

Option	Setting Description		
PFD Presentation (GDU 460 only)	Changes the PFD indicators for airspeed, altitude, vertical speed, and turn coordinator between linear Tapes and circular Round Gauges .		
Attitude Presentation (GDU 460 only)	Changes attitude indicator between Full Screen where the artificial horizon spans the whole screen, and Round Gauge .		
Wind Vector	Off	Disables wind display.	
	Speed/Dir	Displays winds as a single arrow and speed.	
	Head/X-wind	Displays winds as head and crosswind components.	
CDI Scale	Toggles the CDI Scale between 0.25 nm, 1.25 nm, 5.00 nm. NOTE: Applies to internal GPS source only.		
Left/Right Side Knob Action (GDU 460 only)		Left/Right inner knob	Left/Right outer knob
	Course/Baro	CRS value	Local barometric pressure
	Toggle Knob Action (GDU 470 only)	FD Bug/Baro	Flight Director bug
Heading/Altitude		Heading bug	Altitude bug

NOTE: If the PFD Split Screen Side is set to Right in Display Settings, this option will appear as "Left Side Knob Action."

Press To Toggle Knob Action (GDU 460 only)	When enabled, pressing an inner knob will toggle the functionality of inner and outer knobs. Knobs revert to previous functions after 10 seconds. Useful for situations where the split-screen is frequently used.	
<i>NOTE: This setting is always enabled on the GDU 470.</i>		
G Meter	Off	Disables G Meter.
	Auto Display	G Meter appears in place of HSI when G3X Touch detects G load above +2.1G or below -0.5G.
	On (Replace HSI)	G Meter replaces HSI.
Lateral Deviation	Toggles lateral deviation indicator.	
Synthetic Vision	Overlays 3D-rendered terrain on full-screen attitude presentation.	
Ft. Path Marker	Overlays a marker  on full-screen attitude presentation indicating aircraft bearing relative to heading, as affected by winds.	
Pathways	Overlays 3D magenta flight path boxes on full-screen attitude presentation, indicating path to next waypoint.	
Traffic	Overlays indications of specific aircraft on full-screen attitude presentation.	

More PFD Options

G3X TOUCH SYSTEM ANNUNCIATIONS

When an LRU or an LRU function fails, a large red 'X' is typically displayed over the instrument(s) or data experiencing the failure. After starting the system, certain instruments remain invalid as equipment begins to initialize. All instruments should be operational within one minute of starting the system. If any instrument remains flagged, and it is not likely an installation related problem, the G3X Touch should be serviced by a Garmin-authorized repair facility.

AHRS OPERATION

The Attitude and Heading Reference System (AHRS) performs attitude, heading, and vertical acceleration calculations for the G3X Touch System, utilizing GPS, magnetometer, and air data, in addition to information from its internal sensors. Attitude and heading information are updated on the PFD while the AHRS receives appropriate combinations of information from the external sensor inputs.

The AHRS (GSU 25D) corrects for shifts and variations in the Earth’s magnetic field by applying the Magnetic Field Variation Database. The Magnetic Field Variation Database is derived from the International Geomagnetic Reference Field (IGRF). The IGRF is a mathematical model that describes the Earth’s main magnetic field and its annual rate of change. The database is updated approximately every 5 years via a GDU software update. Failure to update this database could lead to erroneous heading information being displayed to the pilot.

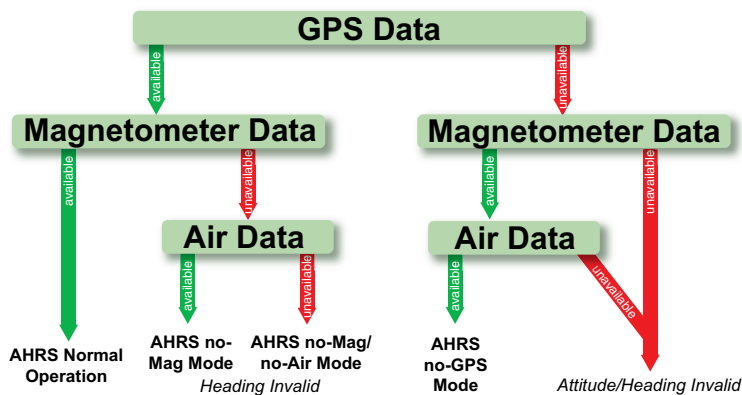

Loss of GPS, magnetometer, or air data inputs is communicated to the pilot by message advisory alerts. Any failure of the internal AHRS inertial sensors results in loss of attitude and heading information (indicated by red ‘X’ flags over the corresponding flight instruments). If the G3X Touch senses the magnetic heading measurement is valid, but possibly outside of the internal accuracy limits, the numeric heading value on the PFD is displayed in yellow.

If GPS input fails, the AHRS can continue to provide attitude and heading information to the PFD as long as magnetometer and airspeed data are available and valid.

If the magnetometer input fails, the AHRS continues to output valid attitude information; however, the heading output on the PFD Page is flagged as invalid with a red ‘X’.

Failure of the air data input has no effect on the AHRS output while AHRS is receiving valid GPS information. Invalid/unavailable airspeed data in addition to GPS failure results in loss of all attitude and heading information. Likewise, loss of magnetometer (heading) data, in combination with loss of GPS data, results in a loss of all attitude and heading information.

If a Garmin G5 or GI 275 standby flight display is installed, it will provide a redundant source of attitude and air data in addition to that provided by the dedicated ADAHRS unit (GSU 25D). If the sensor source selection is AUTO and attitude or air data is unavailable from any dedicated ADAHRS unit, the PFD will automatically revert to displaying data from the standby display. This will be annunciated on the PFD with an 'AHRS REVERT' or 'ADC REVERT' message.

1.6 ACCESSING SYSTEM FUNCTIONALITY

MENUS

The G3X Touch has a dedicated **MENU** Key. Press **MENU** once to display a context-sensitive list of options for the page or the dedicated PFD. Press **MENU** twice to display the Main Menu.

The Page Menu allows the user to access additional features or make setting changes which specifically relate to the currently displayed page. The menu will display 'No Options' when there are no options for the page selected.

DATA ENTRY

Data can be entered by using the touchscreen or the knob. In some instances, such as when entering an identifier, the G3X Touch tries to predict the desired identifier based on the characters being entered. In this case, if the desired identifier appears, touch **Enter** to confirm the entry without entering the rest of the identifier manually. This can save the pilot from having to enter all the characters of the identifier.

Instead of using character-by-character data entry, touch **Find** to search by recent waypoints, nearest waypoints, flight plan waypoints, user waypoints, name, or city.

Entering data:

- 1) With the keypad displayed, begin entering data.
 - a) Touch the desired letters and/or numbers. Touch **Numeric** to access the numbers on a GDU 470.
 - b) Touch **Enter**.
- Or:**
 - a) Touch **Find**.
 - b) Touch the **Recent, Nearest Airports, Flight Plan, User, Search Name**, or **Search City** Tab.
 - c) Touch the desired waypoint from the list.
- Or:**
 - a) Turn the small Knob below the keypad to activate the cursor and enter the first letter and/or number.
 - b) Turn the large Knob below the keypad to move the cursor to the next character position.
 - c) Repeat steps 'b' and 'c' as necessary.
 - d) Touch **Enter** or press the Knob below the keypad.



Data Entry

PAGES

A page navigation bar is displayed on the lower portion of the MFD. The right side shows a list of abbreviated names for each of the pages, and the left side shows the name of the current page.

Touch the page navigation bar to select the desired page or turn the large Knob associated with the MFD to cycle through the pages.

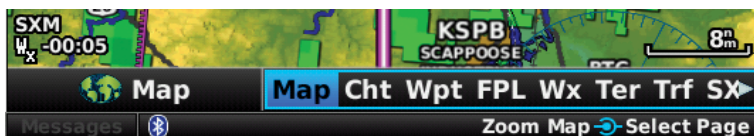

Page Navigation (Example)

MAIN PAGES

Selecting a main page:

- 1) Touch the Page Navigation Bar on the MFD.
- 2) Touch the desired page from the Select Page menu.

Or:

Turn the large Knob associated with the MFD.

- **Main Pages**

Map Page (Map)

Terrain Page (Ter)

Charts Page (Cht)

Traffic Page (Trf)*

Waypoint Page (Wpt)

SiriusXM Page (SXM)*

Active Flight Plan Page (FPL)

Info Page (Info)

Weather Page (Wx) (optional)

Engine Page (Eng)*

*May not be available, dependent upon configuration

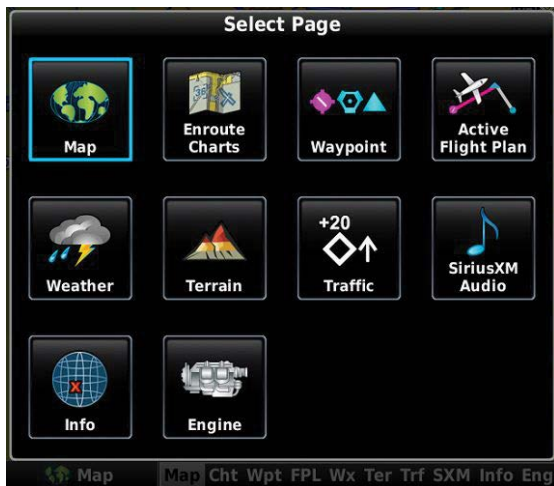

Main Pages

USER ENABLED MAIN PAGES

In Display Setup the user can add or remove the Checklists, Video, and/or SiriusXM Audio page to/from the Main Pages.

Displaying/removing a user enabled main page:

- 1) From the Main Menu, touch **Setup** > **Display**.
- 2) Touch in the **Checklists Main Page**, **Video Main Page**, or **SiriusXM Audio Main Page** field.
- 3) Touch **Show** or **Hide**.

NEAREST PAGES

The Nearest Pages are selected by pressing the **NRST** Key.

Selecting the NRST pages:

- 1) Touch the **NRST** Key.
- 2) Turn the large Knob associated with the MFD.

Or:

- 1) Touch the Page Navigation Bar.
- 2) Touch the desired page from the Select Page menu.

The Nearest Pages contain the following information:

- Apt (Airport)—identifier, bearing, distance, length of the longest runway, and common traffic advisory (CTAF) or tower frequency.
- Wx (Airport Weather) (GDU 4X0 with FIS-B weather receiver)—identifier, bearing, distance, METAR text, and ATIS, AWOS, or ASOS frequency.
- VOR (VHF Omnidirectional Radio Beacon)—identifier, facility type (symbol), bearing, distance, and frequency.
- NDB (Non Directional Beacons)—identifier, facility, type (symbol), bearing, distance, and frequency.
- INT (Intersection)—identifier, bearing, and distance.
- VRP (Visual Reporting Point) (Atlantic)—identifier, bearing, and distance.
- USR (User Waypoints)—name, bearing, and distance.
- CTY (City)—name, bearing, and distance.
- ATC (Air Route Traffic Control Center)—name, bearing, distance, and frequency.
- FSS (Flight Service Station)—name, bearing, distance, frequency, and VOR (if applicable).
- ASPC (Airspace)—name, time to entry (when applicable), and status.

1.7 ACCESSING ADDITIONAL INFORMATION



NOTE: A System Status Message and the word 'External' appearing next to the GPS Status indicates the display connected to the GPS antenna is unavailable and the remaining display(s) are using the external GPS navigator for 2D GPS position data. In this case, the data collected from the external navigator is not considered a sufficient source of GPS data by the AHRS.

VIEWING GPS RECEIVER STATUS

Internal system checking is performed to ensure the GPS receiver is providing accurate data to the GDU(s).

The G3X Touch GDUs can be configured to share GPS information (refer to the G3X Touch Installation Manual for configuration information). For example, a GDU can be configured to share its GPS position, velocity, and time data with another GDU. If a GDU is not using its own GPS receiver, the name of the GDU providing the data (i.e., '3D GPS Location (PFD)' or '3D GPS Location (MFD)') is displayed on the INFO Page.



GPS Status

The GPS Status will display one of the following conditions:

- Autolocate—Receiver is looking for any satellite whose almanac has been collected, which can take up to 5 minutes
- Searching the Sky—Receiver is looking for satellites
- Acquiring Satellites—Receiver is looking for and collecting data from satellites visible at its last known or initialized location, but has not acquired a fix
- 2D GPS Location—At least three satellites have been acquired and a two-dimensional location fix has been calculated. "2D Differential" appears when you are receiving DGPS corrections in 2D mode

- 3D GPS Location—At least four satellites have been acquired and a three-dimensional fix has been calculated. “3D Differential” appears when you are receiving DGPS corrections in 3D mode
- Lost Satellite Reception—the receiver is no longer tracking enough satellites for a 2D or 3D fix

Viewing GPS receiver status information:

Turn the large Knob associated with the MFD to select the Info Page.

Or:

- 1) Touch the Page Navigation Bar on the MFD.
- 2) Touch the **Info** Page from the Select Page menu.

NEW LOCATION

The ‘New Location’ menu option on the **Info** Page is used when the GPS Receiver is having trouble finding the satellites it expects to be there.

Entering a new location:

- 1) From the **Info** Page, while the unit is searching for satellites, press the **MENU** Key.
- 2) Touch **New Location**.
- 3) Touch **Automatic, Use Map, or Use Identifier**.
- 4) After selecting your approximate position using the map or entering an identifier, touch **Enter**.
- 5) The GPS Receiver will begin a new search based on the location entered.

ACQUIRING SATELLITES

When the receiver is in the process of acquiring enough satellite signals for navigation, the receiver uses satellite orbital data (collected continuously from the satellites) and last known position to determine the satellites that should be in view. “Acquiring Satellites” is indicated as the solution until a sufficient number of satellites have been acquired for computing a solution.

When the receiver is in the process of acquiring a 3D differential GPS solution, “3D GPS Location” is indicated as the solution until the 3D differential fix has finished acquisition.

SATELLITE INFORMATION

Satellites currently in view are shown at their respective positions on a satellite constellation diagram. The outer circle of the constellation diagram represents the horizon, the inner circle represents 45° above the horizon, and the center point shows the position directly overhead. Each satellite is represented by a square containing the Pseudo-Random Noise (PRN) number (i.e., satellite identification number).

The **Info** Page can be helpful in troubleshooting weak (or missing) signal levels due to poor satellite coverage or installation problems. As the GPS receiver locks onto satellites, a signal strength bar is displayed for each satellite in view, with the appropriate satellite PRN number (01-32 or 33-64 for WAAS) below each bar. The progress of satellite acquisition is shown in three stages, as indicated by signal bar appearance:

- No bar—Receiver is looking for the indicated satellite
- Gray bar—Receiver has collected the necessary data and the satellite signal can be used
- Green bar—Satellite is being used for the GPS solution

POSITION

The Position box on the **Info** Page displays latitude, longitude, accuracy (in feet), reference waypoint, type, distance, direction, and bearing. The current position can be marked as a user waypoint by touching the latitude and longitude button. The reference waypoint is designed to display the current position in relation to a prominent landmark. The pilot can change the reference waypoint 'Nearest Type' using the 'Change Nearest Type' page menu option. By default the Nearest Type is set to 'Automatic', which will display the nearest large airport, enroute VOR, or city (in that order).

Changing the Nearest Type:

- 1) From the **Info** Page, press the **MENU** Key.
- 2) Touch **Change Nearest Type**.
- 3) Touch **Automatic, Airport, VOR, NDB, Intersection, City, or Waypoint**.

Marking Current Location as a Waypoint:

1) From the **Info** Page, touch the latitude and longitude.

Or:

1) From the **Info** Page, press the **MENU** Key, and touch **Mark Waypoint**.

2) Touch **Yes** on the confirmation dialog box.

3) Optionally touch the **Name** field to rename the waypoint.

4) Touch **Back**.

1.8 SYSTEM SETTINGS

The Setup option in the Main Menu allows management of the following system parameters:

- Data Bar
- Display
- Sound
- Units
- Time
- Map
- Position
- Alarms
- Airspace
- Connex (optional)
- Weather (optional)
- Bluetooth
- PFD (optional)
- XPDR (optional)
- Autopilot (optional)
- Flight Director (optional)
- Navigation
- Keyboard

Accessing system settings:

1) Press the **MENU** Key twice.

2) Touch **Setup**.

3) Touch the desired option on the Setup Page.

TRANSPONDER

If configured to 'Set By Pilot' in configuration mode, (refer to the Installation Manual for configuration information) the pilot can change the Flight ID and enable/disable ADS-B Transmit from the Transponder Setup Page and the Transponder Pop-up Window.

Setting the Flight ID:

- 1) Press the **MENU** Key twice.
- 2) Touch **Setup** > **XPDR**.
- 3) Touch the 'Flight ID' Field.
- 4) Enter the Flight ID and touch **Enter**.

Or:

- 1) Touch the Transponder on the PFD.
- 2) Touch the 'Flight ID' Field.
- 3) Enter the Flight ID and touch **Enter**.

Enabling/disabling ADS-B Transmit:

- 1) Press the **MENU** Key twice.
- 2) Touch **Setup** > **XPDR**.
- 3) Touch the 'ADS-B Transmit' Field.
- 4) Touch **Enabled** or **Disabled**.

DATA BAR SETUP

Displaying the Data Bar Setup Page:

- 1) Press the **MENU** Key twice.
- 2) Touch **Setup** > **Data Bar**.

MODE BUTTON SCREEN SIDE

Determines which side of the display the Mode Button  is shown. Settings are **Auto**, **Left**, and **Right**.

COM RADIO SCREEN SIDE

Adjusts the position of the COM Radio control to either the **Left** or **Right** side of the Data Bar. This setting is only allowed for single COM radio installations (with dual COM radio installations, COM 1 is always on the left and COM 2 is always on the right).

COM RADIO VOLUME INDICATOR

Used to display (temporarily) volume indicator  on the Data Bar, settings are **Show** and **Hide**.

COM RADIO VOLUME SHORTCUT (GDU 460 ONLY)

When enabled, this option provides quick access to the selected COM radio volume control by dedicating one of the GDU knobs to volume and squelch when the tune radio page is the active page (**Set Volume / Push Squelch** annunciated on screen just above knob). When disabled, the tune radio page dedicates all available knobs to setting and tuning the standby frequency (i.e., a single knob in split-screen display mode, or both knobs in full-screen display mode).

TRANSPONDER SCREEN SIDE

Adjusts the position of the transponder control to either the **Left** or **Right** side of the Data Bar.

AUDIO PANEL SCREEN SIDE

Adjusts the position of the audio panel control to either the **Left** or **Right** side of the Data Bar.

AUDIO PANEL CONTROLS

Displays either **Normal** or **Minimized** audio panel controls on the Data Bar.

AUDIO PANEL VOLUME SHORT-CUT (GDU 460 ONLY)

Enables or **Disables** the audio panel volume short-cut.

USER TIMER BUTTON

Used to change the display of the User Timer Button  on the Data Bar. Selections are: Hide, Show on Left, and Show on Right. The User Timer can also be accessed from the User Timer icon on the Main Menu, from the PFD Option Menu, and by pressing "TMR 00:00" on the PFD status bar (when visible - GDU 470). Press the User Timer Button to start/stop the timer, press Reset to reset the timer.

MAX DISPLAYED FIELD COUNT (GDU 460 ONLY)

Used to select the maximum number (1-8) of available data boxes shown on the Data Bar.

DATA FIELDS

Refer to the Annunciations and Alerts Section for a list of available Data Bar Field options.

Changing the information shown in the Data Bar fields:

- 1) Press the **MENU** Key twice.
- 2) Touch **Setup > Data Bar > Data Fields**.
- 3) Touch one of the Data Bar fields.
- 4) Touch a new data field from the list.

GENERAL DISPLAY INFORMATION

BACKLIGHT SETTINGS

The Backlight Intensity (display brightness) can be set to 'Manual', 'Light Bus', or 'Photo Cell'. With 'Manual' selected, the pilot can manually adjust the desired backlight intensity. After each power cycle the Backlight Intensity is set to the default, which is configurable. Refer to the G3X Touch Installation Manual for more information.

EIS DISPLAY LOCATION (OPTIONAL)

In Configuration Mode the 'EIS Display Location' setting can be set to one of the following:

- **AUTO**—Displays the EIS Strip on the MFD, or on the PFD if the MFD is not displayed.
- **PFD**—Always displays the EIS Strip on PFD .
- **User Selected**—Enables the user to choose between 'AUTO' and 'PFD' via the Display Setup menu.

For more information on how to enable the 'EIS Display Location' setting in Configuration Mode refer to the G3X Touch Installation Manual.

SCREENSHOT

Saving a Screenshot to the SD Card (if Screenshot function is enabled):

- 1) Navigate to the desired screen.
- 2) Press and hold the MENU Key. A 'Screenshot saved to card' message will appear.

SCREEN CLEANING

Cleaning the display:

- 1) Press the MENU Key twice.
- 2) Touch Tools > Screen Cleaning.
- 3) Clean screen with a clean, lint-free cloth (such as the Garmin cleaning cloth). Avoid any chemical cleaners or solvents that can damage plastic components.
- 4) Per the on-screen instructions, press the MENU Key to swap sides of the display, or press the BACK Key to return to Tools.



NOTE: Make sure that no dust or grit accumulates at the bottom of the display glass. The GDU displays use invisible infrared beams for touch detection, this makes it very important to keep the screen clean, especially along the edges.

DISPLAY SETUP

Accessing Display Setup Options:

- 1) Press the MENU Key twice.
- 2) Touch Setup > Display.

Setting	Options	Description	Notes
Backlight Control	Manual	Provides configurable manual control	
	Light Bus	Adjusts backlight according to external cockpit control, if connected	
	Photo Cell	Uses bezel light sensor to automatically adjust backlight to complement ambient light level	
Backlight Intensity	Slider Control	Directly sets backlight level if Backlight Control is set to Manual	
Startup Page	Page	List of specific pages to display on startup.	
Startup Page	Full	Enables or disables Split Screen on startup	GDU 460 PFD only
	Split		
Toggle Split Screen with BACK key	Disable	Enables/Disables Split Screen operation using the BACK key	
	Enable		
PFD Split Screen Side	Left	Specifies the screen side the PFD page appears on	GDU 460 (no EIS) PFD only
	Right		
Full MFD/PFD Toggle	Enable	Shows or hides MFD/PFD toggle button	GDU 470 MFD only
	Disable		
MFD Split Screen Page	Map	Specifies page to display after switching MFD to Split Screen	GDU 460 MFD only
	Chart		
	PFD		
MFD Split Screen Side	Left	Specifies which side the MFD Split Screen appears on	GDU 460 MFD only
	Right		

Display Setup Options

Setting	Options	Description	Notes
PFD Split Screen Ratio	Narrow	Narrower PFD, wider Split Screen	GDU 460 PFD only (not available when PFD is displaying the engine bar)
	Normal	Equal PFD and Split Screen areas	
	Wide	Wider PFD, narrower Split Screen	
EIS Display Location	MFD	Specifies which displays show the Engine Indication System strip	Do not display EIS on a GDU 470 PFD
	PFD		
	Both		
EIS Screen Side	Left	Specifies which side of the screen that the EIS strip appears on	GDU 460 only; not available for some MFD installations
	Right		
COM Radio Display Location	MFD	Specifies which displays show the COM Radio buttons	
	PFD		
	Both		
Transponder Display Location	MFD	Specifies which displays show the Transponder buttons	
	PFD		
	Both		
On-Screen Zoom Buttons	Show	Shows or hides zoom buttons 	
	Hide		
Knob Zoom Action	Normal	Clockwise zooms in, in Maps and Charts	
	Reverse	Clockwise zooms out, in Maps and Charts	

Display Setup Options

Setting	Options	Description	Notes
Map Color Mode	Day	Full color map features	
	Night	High-contrast mode	
	Auto	Change depending on local time	
Chart Color Mode	Day	Full color chart features	
	Night	High-contrast mode	
	Auto	Change depending on local time	
Sirius Audio Main Page	Show	Shows or hides the Sirius Audio Main Page	
	Hide		
Screenshot	Disabled	Allows capturing of screenshots. Field is available immediately when an SD card is inserted. See Appendix C.	
	Enabled		

Display Setup Options

SOUND SETUP

The pilot can manually adjust the desired SXM Volume, Message Volume, Traffic N/A Alert, Altitude Alert (On/Off), and Minimums Alert (On/Off). Message Volume controls the banner message tones (e.g., "Approaching Airspace" or "Arriving at Waypoint"). Alert Volume (e.g., terrain, traffic, autopilot, etc.) is set in configuration mode (refer to the G3X Touch Installation Manual for more information).

Adjusting SXM and/or Message Volume:

- 1) Press the **MENU** Key twice.
- 2) Touch **Setup > Sound**.
- 3) Touch the 'SXM Volume' or 'Message Volume' Field.
- 4) Touch and drag the slider to the desired percentage.

Enabling/disabling the 'Traffic Not Available' audio alert:



NOTE: Refer to the Hazard Avoidance section for more information regarding the 'Traffic Not Available' audio alert.

- 1) Press the **MENU** Key twice.
- 2) Touch **Setup** > **Sound**.
- 3) Touch **Enabled** or **Disabled** in the 'Traffic N/A Alert' Field.

Turning the altitude alert tone on/off:



NOTE: Refer to the Flight Instruments section for more information regarding the Altitude Alert Tone.

- 1) Press the **MENU** Key twice.
- 2) Touch **Setup** > **Sound**.
- 3) Touch **Enabled** or **Disabled** in the 'Altitude Alert' Field.

Turning the minimums alert tone on/off:



NOTE: Refer to the Flight Instruments section for more information regarding the Minimums Alert Tone.

- 1) Press the **MENU** Key twice.
- 2) Touch **Setup** > **Sound**.
- 3) Touch **Enabled** or **Disabled** in the 'Minimums Alert' Field.

UNITS SETUP

Changing unit settings:

- 1) Press the **MENU** Key twice.
- 2) Touch **Setup** > **Units**.
- 3) Touch the desired field.
- 4) Touch the desired units.

Setting	Options
Air Temperature	Fahrenheit (°F)
	Celsius (°C)
Baro Pressure	Inches (Hg)
	Millibars (Mb)
	Hectopascals (hPa)
Weight	Pounds (lbs)
	Kilograms (kg)

Units Setup Options

TIME SETUP

Changing the time zone settings:

- 1) Press the **MENU** Key twice.
- 2) Touch **Setup** > **Time**.
- 3) Touch **Auto** or **Manual** in the 'Time Zone' Field. Manual allows the pilot to adjust the UTC offset in 15 minute increments (HH:MM).

Changing the time format:

- 1) Press the **MENU** Key twice.
- 2) Touch **Setup** > **Time**.
- 3) Touch the 'Time Format' Field.
- 4) Touch **12 Hour**, **24 Hour**, or **UTC**.

MAP SETUP

Refer to section 5.2.

POSITION SETUP



NOTE: Refer to Appendix D for more information on Map Datums and Location Formats.

Changing position settings:

- 1) Press the **MENU** Key twice.
- 2) Touch **Setup** > **Position**.
- 3) Touch the desired field to change.
- 4) Touch the desired setting from the list.

ALARMS SETUP

The Airspace Page allows the pilot to turn airspace alarms On/Off. The Alarms Page allows the pilot to enable/disable the Arrival Alarm, Next Waypoint Alarm, Proximity Alarm, and Fuel Tank Reminder Alarm.

Enabling/disabling the arrival alarm:

- 1) Press the **MENU** Key twice.
- 2) Touch **Setup** > **Alarms**.
- 3) Touch **On** or **Off** in the 'Arrival' Field.
- 4) If necessary, touch the arrival distance value.
- 5) Enter the desired distance using the keypad and touch **Enter**.

Changing the next waypoint alarm settings:

- 1) Press the **MENU** Key twice.
- 2) Touch **Setup** > **Alarms**.
- 3) Touch  to display the next waypoint alarm options.
- 4) Touch **Off**, **Distance**, or **Time**.
- 5) If **Time** is selected, touch + or - to adjust the time (MM:SS).
- 6) If **Distance** is selected, touch the distance value and enter the desired distance using the keypad.

Enabling/disabling the proximity waypoint alarm:

- 1) Press the **MENU** Key twice.
- 2) Touch **Setup > Alarms**.
- 3) Touch **On** or **Off** in the 'Proximity Waypoint' Field.

Enabling/disabling the fuel tank reminder alarm:

- 1) Press the **MENU** Key twice.
- 2) Touch **Setup > Alarms**.
- 3) Touch **On** or **Off** in the 'Fuel Tank Reminder' Field.
- 4) With the 'Fuel Tank Reminder' 'On', touch '+' or '-' to adjust the time interval in 5 minute increments.

FUEL TANK REMINDER ALARM AND FUEL TANK TIMER

The 'Fuel Tank' Reminder alarm is used as a reminder to switch fuel tanks. The reminder message repeats at the specified interval after the beginning of each trip. The Fuel Tank Timer (FUEL TIMER) data field option is the elapsed time since the 'Fuel Tank' Reminder alarm was last issued (MM:SS). There is also an option for an amount-based fuel tank reminder alarm which will alert the pilot when a specified fuel used interval has been met.



NOTE: If 'Fuel Used Reset' in the Engine Setup Menu is set to **Auto**, the amount-based fuel tank reminder will reset on each power cycle. If set to **Manual**, the fuel used at the time of the last shutdown is retained through the next power cycle.

AIRSPACE SETUP

The Airspace Alarms Setup page allows the pilot to enable/disable airspace alarms for the following airspace: ClassB/TMA, Class C/TCA, Class D, Restricted, MOA (Military), Other/ADIZ, or Euro Airway.

Enabling/disabling airspace alarms:

- 1) Press the **MENU** Key twice.
- 2) Touch **Setup** > **Airspace**.
- 3) Touch **On** or **Off** to enable/disable the desired airspace alarms.

BLUETOOTH SETUP

Refer to Section 8.9.

PFD SETUP

Refer to Section 1.5.

NAVIGATION SETUP

Waypoint Transition Mode can be set to 'Auto' or 'Distance'. In 'Auto' mode the G3X Touch selects the "best" next waypoint based on the aircraft's present position. 'Distance' mode allows the pilot to enter a radius around the active leg destination so that when the aircraft is within the entered distance, the G3X Touch transitions to the next waypoint in the route.

Changing the waypoint transition mode:

- 1) Press the **MENU** Key twice.
- 2) Touch **Setup** > **Navigation**.
- 3) Touch  to display the waypoint transition mode options.
- 4) When selecting **Distance**, touch the distance value, enter the desired distance using the keypad, and touch **Enter**.

KEYBOARD SETUP

Changing keyboard settings:

- 1) Press the **MENU** Key twice.
- 2) Touch **Setup** > **Keyboard**.
- 3) Touch **ABCDE** or **QWERTY** in the 'Keyboard Format' Field.

SECTION 2 FLIGHT INSTRUMENTS

2.1 FLIGHT INSTRUMENTS



NOTE: Refer to Section 9 for Autopilot information.

Increased situational awareness is provided by replacing the traditional instruments on the panel with an easy-to-scan Primary Flight Display (PFD) that features a horizon, airspeed, attitude, altitude, vertical speed, heading, and course deviation information.



PFD (Full Screen)

The following flight instruments and supplemental flight data are displayed on the PFD.



NOTE: GDU™ 460 displays can present the primary flight instruments in round gauge format. Access this setting via the "PFD Presentation" item on the PFD Setup page from the Main Menu and select "Round Gauges."

- | | |
|--|---|
| 1 AFCS Status Box | 24 Bearing 2 Pointer |
| 2 True Airspeed (TAS) | 25 Selected Heading Bug |
| 3 Airspeed Indicator | 26 Bearing 2 Information |
| 4 Attitude Indicator | 27 Course Deviation Indicator (CDI) |
| 5 Pitch Scale | 28 CDI Scale |
| 6 Airspeed Trend Indicator | 29 CAS Message Window |
| 7 Flight Director Command Bars | 30 Baro Minimums Box |
| 8 Aircraft Symbol | 31 Selected Course |
| 9 Slip/Skid Indicator | 32 Altimeter Barometric Setting |
| 10 Lateral Deviation Scale & Course Deviation | 33 Altimeter |
| 11 Vspeed Reference | 34 Baro Minimums Bug |
| 12 Ground Speed (GS) | 35 Required Vertical Speed |
| 13 Selected Heading | 36 Selected Vertical Speed Bug |
| 14 Wind Speed/Crosswind Component (Toggle) | 37 Current Vertical Speed |
| 15 Wind Direction/Head Wind Component (Toggle) | 38 Vertical Speed Indicator (VSI) |
| 16 Current Heading/Track Indicator | 39 Selected Altitude Bug |
| 17 Course Pointer | 40 Reference Altitude |
| 18 Bearing 1 Pointer | 41 VNAV Target Altitude |
| 19 Navigation Source | 42 VNAV Indicator or Vertical Deviation Indicator |
| 20 Horizontal Situation Indicator (HSI) | 43 Zero Pitch Line |
| 21 Bearing 1 Information | 44 Standard Rate Turn Triangle |
| 22 Standard Rate Turn Indicator | 45 Flight Path Marker |
| 23 Half-standard Rate Turn Indicator | 46 ESP Limits |

AIRSPEED INDICATOR



NOTE: The G3X Touch™ Vspeed Reference values and Flaps Tick Mark values depend upon the aircraft’s specific system configuration and may vary from the examples discussed in this section.

The Airspeed Indicator displays airspeed on a rolling number gauge using a moving tape. The true airspeed (TAS) is displayed in knots above the Airspeed Indicator. The numeric labels and major tick marks on the moving tape are marked at intervals of 10 knots, miles per hour, or kilometers (depending on system configuration). Speed indication starts at 30 knots. The actual airspeed is displayed inside the black pointer. The pointer remains black until reaching never-exceed speed (V_{NE}), at which point it turns red.

A color-coded (red, white, green, yellow, and red/white “barber pole”) speed range strip is located on the moving tape. The colors denote flaps operating range, normal operating range, caution range, and never-exceed speed (V_{NE}). A red range is also present for low speed awareness.

The Airspeed Trend Vector is a vertical, magenta line, extending up or down on the airspeed scale, shown to the right of the color-coded speed range strip. The end of the trend vector corresponds to the predicted airspeed in 6 seconds if the current rate of acceleration is maintained. If the trend vector crosses V_{NE} , the text of the actual airspeed changes to yellow. The trend vector is absent if the speed remains constant or if any data needed to calculate airspeed is not available due to a system failure.

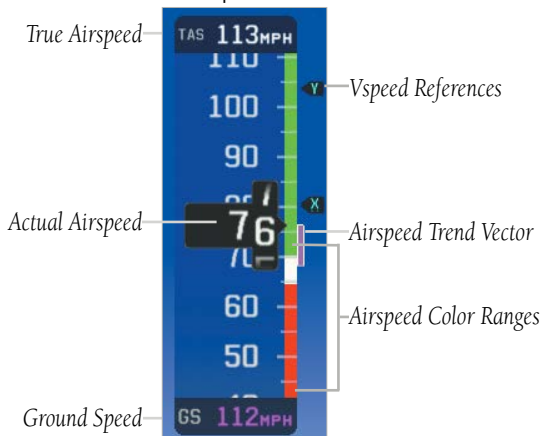

Airspeed Indicator

V_{NE} ADJUSTED FOR TRUE AIRSPEED OR MACH NUMBER (OPTIONAL)

The airspeed indicator can optionally be configured to display V_{NE} adjusted for true airspeed or maximum Mach number (MMO). This is useful in aircraft where true airspeed or Mach number must be kept below a certain limit. If configured, the G3X Touch PFD can calculate an adjusted V_{NE} based on TAS or Mach in addition to IAS, which will cause the displayed value for V_{NE} to be reduced at high altitudes. A solid red band is used between the TAS or Mach limit and the actual indicated value for V_{NE}.



V_{ne} Adjusted for True Airspeed

VSPEED REFERENCE

Vspeed references including V_{NE}, V_{no}, V_{so}, V_{s1}, V_{fe}, V_a, V_x, V_y, V_{yse}, V_g, V_r, as well as several custom Vspseds can be configured from the Aircraft Configuration Page, refer to the G3X Touch Installation Manual for more information.

When airspeed is present, the Vspseds configured are also displayed at their respective locations to the right of the airspeed scale, otherwise the Vspseds are displayed at the bottom of the airspeed indicator.

- System Overview
- Flight Instruments
- EIS
- CNS Interface
- GPS Navigation
- Flight Planning
- Hazard Avoidance
- Additional Features
- AFCs
- Annun/Alerts
- Appendix
- Index

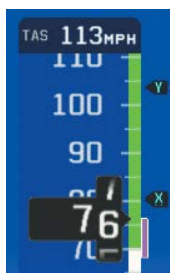

**Vspeed References
(with airspeed)**



**Vspeed References
(without airspeed)**

Vspeed References

Vspeed References

ATTITUDE INDICATOR

Attitude information is displayed over a virtual blue sky and brown ground with a white horizon line. The Attitude Indicator displays the pitch (indicated by the yellow symbolic aircraft on the pitch scale), roll, and slip/skid information.

The horizon line is part of the pitch scale. Pitch markings occur at 2.5° intervals through all pitch ranges.

The inverted white triangle indicates zero on the roll scale. Major tick marks at 30° and 60° and minor tick marks at 10°, 20°, and 45° are shown to the left and right of the zero. Angle of bank is indicated by the position of the pointer on the roll scale.

Slip/skid is indicated by the location of the ball.

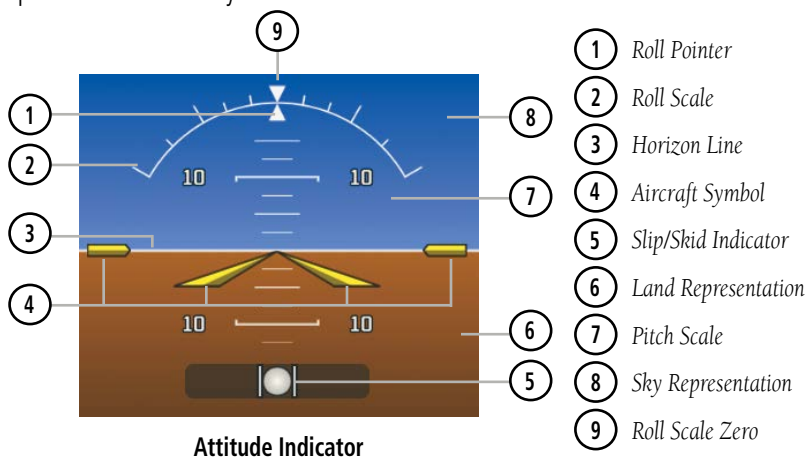

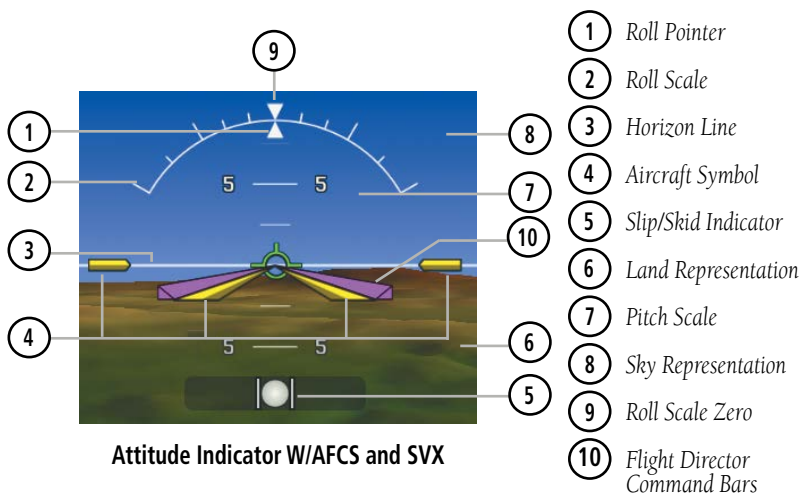

- 1 Roll Pointer
- 2 Roll Scale
- 3 Horizon Line
- 4 Aircraft Symbol
- 5 Slip/Skid Indicator
- 6 Land Representation
- 7 Pitch Scale
- 8 Sky Representation
- 9 Roll Scale Zero
- 10 Flight Director Command Bars

STANDARD RATE TURN BANK ANGLE POINTERS

The Standard Rate Turn Bank Angle Pointers are green pointers displayed on the roll scale that shows the bank angle that is needed for a standard rate turn.



Standard Rate Turn Bank Angle Pointers

Displaying the standard rate turn bank angle pointers:

- 1) With the full screen PFD displayed, press the **MENU** Key.
- 2) Touch **More Options...**
- 3) Touch  in the **Standard Rate Turn Bank Angle Pointers** group to display the Standard Rate Turn Bank Angle Pointers options.
- 4) Touch **Show**.

ATTITUDE CONFIGURATION

The roll (bank angle) indication may be configured to be a Ground Pointer (default) or a Sky Pointer. Refer to the G3X Touch Installation Manual for configuration information.

The Ground Pointer configuration displays both the roll arc and the pitch scale anchored to the horizon and the roll pointer beneath the roll arc pointing to the present roll angle.

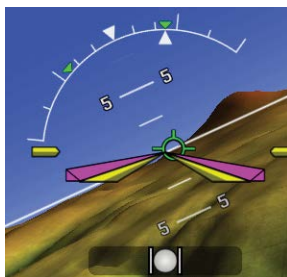

Ground Pointer Configuration

The Sky Pointer configuration displays the pitch scale moving with the horizon, but the roll arc remains fixed and centered in the display. The roll pointer beneath the roll arc moves with the horizon and in the opposite direction of aircraft roll.

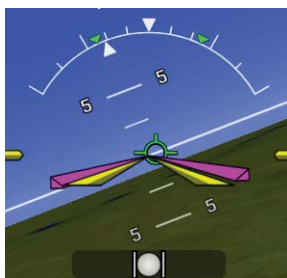

Sky Pointer Configuration

ALTIMETER



NOTE: When using QFE barometric settings, ESP functionality may be unavailable in many cases, especially at lower altitudes. ESP availability can be determined by noting the presence or absence of the Roll Limit Indicators on the attitude display, refer to the Electronic Stability & Protection section of this document.

The Altimeter displays 400 feet of barometric altitude values at a time on a rolling number gauge using a moving tape. Numeric labels and major tick marks are shown at intervals of 100 feet. Minor tick marks are at intervals of 20 feet. The current altitude is displayed in the black pointer.

The Selected Altitude is displayed above the Altimeter in the box indicated by a selection bug symbol. A bug corresponding to this altitude is shown on the tape; if the Selected Altitude exceeds the range shown on the tape, the bug appears at the corresponding edge of the tape.

Setting the selected altitude:

Turn the large Knob associated with the PFD to set the Selected Altitude in 100-ft increments.

Or:

- 1) Touch the Selected Altitude.
- 2) Enter the desired altitude using the keypad and touch **Enter**.

Syncing to the current altitude:

- 1) Touch the Selected Altitude.
- 2) Touch **Set to Current** and touch **Enter**.



NOTE: 'Set For Field' is only available when aircraft is on ground.

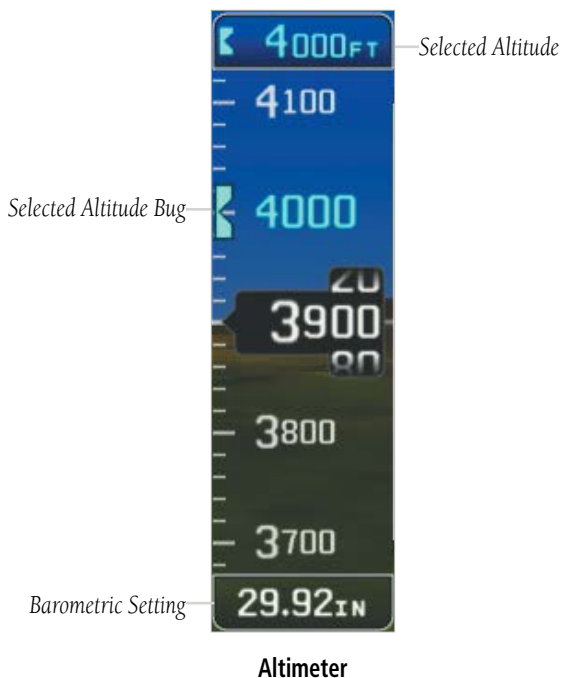

BAROMETRIC PRESSURE

The barometric pressure setting is displayed below the Altimeter in inches of mercury (in Hg) or hectopascals (hPa) when metric units are selected.

Selecting the altimeter barometric pressure setting:

Turn the Knob associated with the PFD to set the barometric pressure.

Or:

- 1) Touch the Barometric Pressure on the PFD.
- 2) Touch the **Set For Field** button if aircraft is on the ground.

Or:

- 3) Touch the **Set To Standard** button if aircraft is in the air.

Or:

- 4) Enter the desired pressure using the keypad and touch **Enter**.

Syncing to the local barometric pressure setting:

- 1) From the PFD Page, touch the barometric pressure.
- 2) Touch 'Set For Field'.
- 3) Verify indicated altitude matches local field elevation.

BAROMETRIC SYNC BETWEEN THE PFD AND A G5 OR GI 275

If a G5 or GI 275 is installed, the barometric pressure setting can be synchronized between the G5/GI 275 and the G3X Touch PFD. When the barometric setting is changed on one of them, the barometric setting on the other turns inverse video cyan while the value is changing.

Enabling/disabling G5/GI 275 baro synchronization:

- 1) Press **Menu** twice.
- 2) Touch **Setup**.
- 3) Touch **PFD**
- 4) Touch **SFD Baro Sync**.
- 5) Touch **Enabled** or **Disabled**.

BAROMETRIC MINIMUM ALERT



NOTE: The pilot must update the Barometric Minimum if a new approach is loaded. Previous approach minimums are not automatically cleared when loading a new approach.

For altitude awareness, a barometric Minimum Descent Altitude (MDA) or Decision Height (DH) can be set by the user and is reset when the power is cycled. Once the user-defined altitude is within the range of the tape, a cyan bug appears at the reference altitude on the Altimeter. Once the aircraft reaches the user-defined MDA/DH, the bug and text turn yellow and the aural alert, "Minimums Minimums", is heard.

Cyan Within Range

Yellow When Altitude Reached

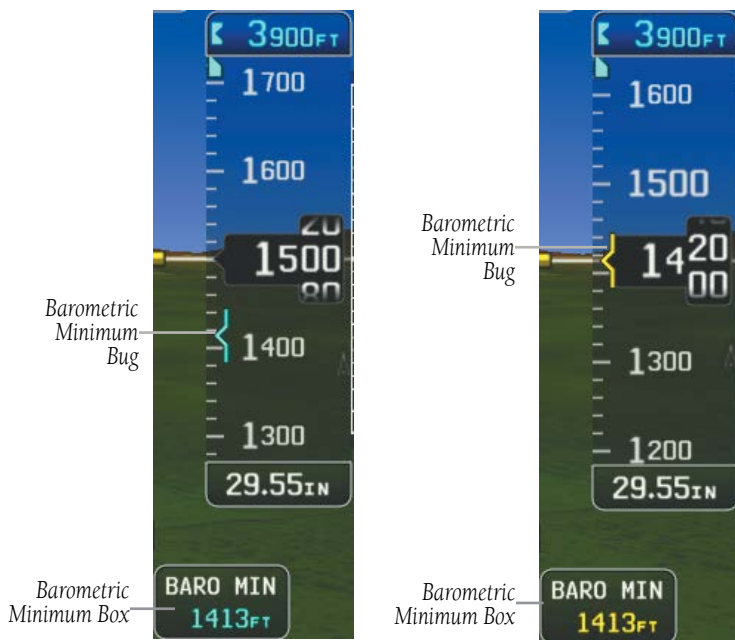

Barometric Minimum Visual Annunciations

Setting the barometric minimum alert bug:

- 1) With the full screen PFD displayed, press the **MENU** Key.
- 2) Touch **Set...** in the Minimums Field.
- 3) Enter the minimum altitude using the keypad and touch **Enter**.

Turning the minimums alert tone on/off:

- 1) Press the **MENU** Key twice.
- 2) Touch **Setup > Sound**.
- 3) Touch **Disabled** or **Enabled** in the Minimums Alert field.

ALTITUDE ALERTING

The Altitude Alerting function provides the pilot with visual and aural alerts when approaching the Selected Altitude. Whenever the Selected Altitude is changed, the Altitude Alerter is reset. The following will occur when approaching the Selected Altitude:

- Passing within 1000 feet of the Selected Altitude, the Selected Altitude (shown above the Altimeter) flashes for 5 seconds and an aural tone is generated.
- When the aircraft passes within 200 ft of the Selected Altitude, the Selected Altitude flashes for 5 seconds and an aural tone is generated to indicate the aircraft is approaching the selected altitude.
- After reaching the Selected Altitude, if the pilot flies outside the deviation band (± 200 Feet of the Selected Altitude), the Selected Altitude changes to yellow text, flashes for 5 seconds, and an aural tone is generated.

Deviation of ± 200 ft



Altitude Alerting Visual Annunciation

Turning the altitude alert tone on/off:

- 1) Press the **MENU** Key twice.
- 2) Touch **Setup > Sound**.
- 3) Touch **Disabled** or **Enabled** in the Altitude Alert field.

VERTICAL SPEED INDICATOR (VSI)

The Vertical Speed Indicator displays the aircraft vertical speed using a non-moving tape labeled in fpm with minor tick marks every 100 feet up to 1000 fpm and major tick marks every 500 feet. The current vertical speed is displayed using a white arrow along the tape.

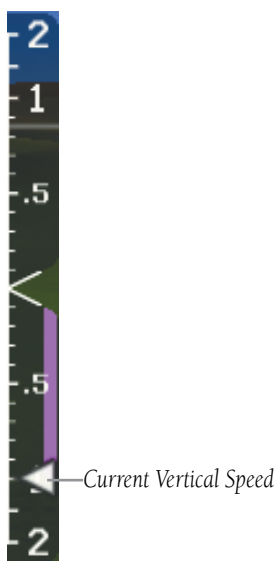

Vertical Speed Indicator

VERTICAL DEVIATION INDICATOR AND VNAV INDICATOR



NOTE: An external navigator must be configured to receive glideslope and/or glidepath vertical deviation indications.

GLIDESLOPE - ILS SOURCE

The Vertical Deviation (Glideslope) Indicator (VDI) appears to the left of the altimeter whenever an ILS frequency is tuned in the active NAV field of an external navigator. A green diamond acts as the VDI Indicator, like a glideslope needle on a conventional indicator. The green 'G' indicates a external glideslope source. If a localizer frequency is tuned and there is no glideslope signal, "NO GS" is annunciated.

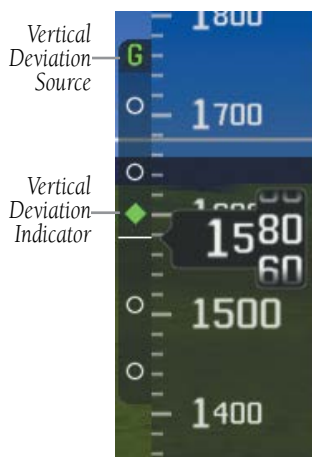

Vertical Deviation Indicator (Glideslope-ILS Source)

GLIDEPATH - GPS SOURCE

The Vertical Deviation (Glidepath) Indicator (VDI) also appears to the left of the altimeter during a GPS approach. The glidepath is analogous to the glideslope for GPS approaches supporting WAAS vertical guidance (LNAV+V, L/VNAV, LPV, LP+V). The Glidepath Indicator appears on the G3X Touch as a magenta diamond. The magenta 'G' indicates a external GPS source. If the approach type downgrades past the final approach fix (FAF), "NO GP" is annunciated.

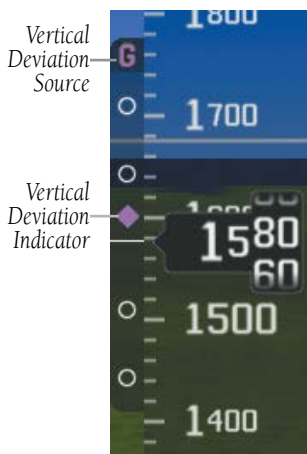

**Vertical Deviation Indicator
(Glidepath-GPS Source)**

VNAV INDICATOR

An external navigation source is not required to receive VNAV indications (although if an external navigator is used, VNAV settings are hidden on the PFD with the exception of vertical deviation which is received from the external navigator). When the VNAV profile is defined, the pilot may be informed of the progress by message alerts, if configured. A magenta chevron (VNAV Indicator) to the left of the altimeter on the Vertical Deviation Scale shows the VNAV profile, and a magenta chevron (Required Vertical Speed Indicator (RVSI)) on the Vertical Speed Indicator indicates the required vertical speed to reach the target altitude. The magenta 'V' indicates a VNAV profile is active. Refer to Section 2.3 for more information. The VNAV deviation indicator and the glideslope/glidepath deviation indicators may be shown simultaneously when applicable.

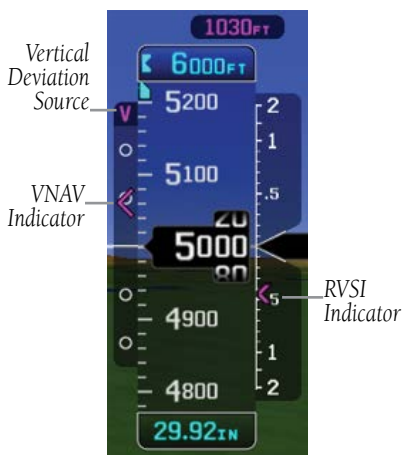

VNAV Indicator

System Overview

Flight Instruments

EIS

CNS Interface

GPS Navigation

Flight Planning

Hazard Avoidance

Additional Features

AFCs

Annun/Alerts

Appendix

Index

HORIZONTAL SITUATION INDICATOR (HSI)

The Horizontal Situation Indicator (HSI) displays a rotating compass card in a heading-up orientation at the bottom of the page. Letters indicate the cardinal points and numeric labels occur every 30°. Major tick marks are at 10° intervals and minor tick marks at 5° intervals. The current track is represented on the HSI by a magenta triangle and dashed line. The HSI also presents course deviation, bearing, and navigation source information.

The Selected Heading is shown to the left of the HSI. The cyan bug on the compass rose corresponds to the Selected Heading.

Adjusting the selected heading:

Turn the small left Knob associated with the PFD to adjust the selected heading.

Or:

- 1) Touch the selected heading on the PFD.
- 2) Enter the desired heading using the keypad and touch **Enter**.

Syncing to the current heading:

- 1) Touch the selected heading on the PFD.
- 2) Touch **Set To Current** and touch **Enter**.

Or:

- 1) If necessary, press the PFD Knob to toggle from Baro to Heading.
- 2) Press the PFD Knob to sync to current heading.

- System Overview
- Flight Instruments**
- EIS
- CNS Interface
- GPS Navigation
- Flight Planning
- Hazard Avoidance
- Additional Features
- AFCS
- Annun/Alerts
- Appendix
- Index



- | | |
|--|----------------------------|
| ① Course Deviation & To/From Indicator | ⑦ Rotating Compass Rose |
| ② Selected Heading | ⑧ Selected Heading Bug |
| ③ Current Heading | ⑨ Aircraft Symbol |
| ④ Turn Rate Indicator | ⑩ To/From Indicator |
| ⑤ Navigation Source | ⑪ Lateral Deviation Scales |
| ⑥ Course Deviation Indicator (CDI) | ⑫ Selected Course |

Horizontal Situation Indicator (HSI)

HSI ANNUNCIATIONS



NOTE: Some or all HSI annunciations may appear in the four quadrants of the G3X Touch HSI depending on the external navigator(s) configured.

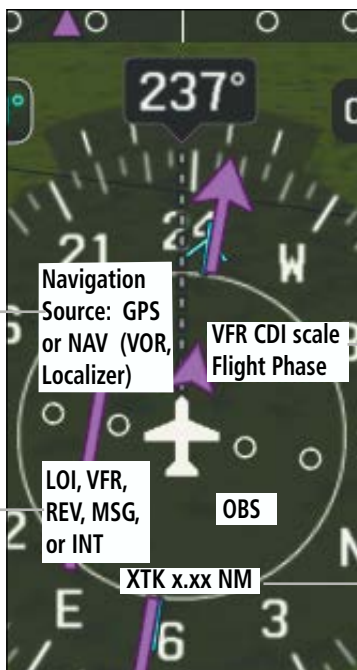

'1' or '2' will appear after the Navigation Source if more than one external navigation source is configured.

LOI: Loss of GPS integrity.

VFR: An external GPS source is configured but there is not enough guidance data for IFR use or the pilot has elected to use the internal VFR GPS for navigation. Refer to color explanations below.

REV: External Navigation Source failed. Reverted to internal VFR GPS for navigation.

MSG: External navigation source has a pending message

INT: The pilot has elected to use the internal GPS navigation source instead of the external GPS navigation source.

VFR CDI Scales:
0.25nm, 1.25nm,
5.00nm

Flight Phase
(IFR): APR, TERM,
ENR, OCN, LNAV,
L/VNAV, LNAV+V,
LPV, or LP+V

Cross Track Value:
'XTK x.xx NM' or
similar

HSI Annunciations

EXTERNAL GPS NAVIGATOR CONFIGURED

External GPS Navigator Failure

If the external GPS navigator fails and the system reverts to the internal GPS, the REV and VFR annunciations are displayed in yellow.



*REV (Yellow):
External Navigation Source failed. Reverted to internal VFR GPS for navigation*

VFR (Yellow)

External GPS Navigator Failure

Intentional Pilot Selection of Internal GPS Navigation

If the external GPS navigator is configured (and functioning), however the pilot has elected to use the internal GPS navigation source, the INT annunciation is displayed in cyan and the VFR annunciation is displayed in magenta.



*INT (Cyan):
The pilot has elected to use the internal GPS navigation source instead of the external GPS navigation.*

VFR (Magenta)

Intentional Pilot Selection of Internal GPS Navigation

BEARING POINTERS AND INFORMATION WINDOWS

Two bearing pointers and associated information can be displayed on the HSI for NAV (VOR, Localizer) and GPS sources as well as nearest or best airports. The bearing pointers are cyan and are single-line (Bearing Pointer 1) or double-line (Bearing Pointer 2). A pointer symbol is shown in the information windows to indicate the navigation source. The bearing pointers never override the CDI and are visually separated from the CDI by a white ring (shown when the bearing pointers are selected but not necessarily visible due to data unavailability).

When a bearing pointer is displayed, its associated information window is also displayed. The Bearing Information Windows are displayed at the lower sides of the HSI. The following information may be displayed in the Bearing Information Windows:

- Bearing source (NAV, GPS)
- Pointer icon (single lined or double lined)
- Frequency (NAV)
- Station/waypoint identifier (NAV, GPS)
- GPS-derived great circle distance to bearing source

If an external NAV radio is the bearing source and it is tuned to an ILS frequency, the bearing source and the bearing pointer are removed from the HSI and the frequency is replaced with "ILS". If VLOC1 or VLOC2 is the bearing source and it is tuned to a VOR frequency, the frequency is replaced with the station identifier. If GPS is the bearing source, the active waypoint identifier is displayed in lieu of a frequency.

The bearing pointer is removed from the HSI and "NO DATA" is displayed in the information window if:

- The NAV radio is not receiving the tuned VOR station
- GPS is the bearing source and an active waypoint is not selected

- System Overview
- Flight Instruments
- EIS
- CNS Interface
- GPS Navigation
- Flight Planning
- Hazard Avoidance
- Additional Features
- AFCs
- Annun/Alerts
- Appendix
- Index



Bearing 1 Information Window
-Identifier
-Bearing Source

Bearing 2 Information Window
-Identifier
-Distance

HSI with Bearing Pointers

Enabling/disabling the bearing pointer and changing sources:

- 1) With the full screen PFD displayed, press the **MENU** Key.
- 2) Touch next to a bearing pointer to display the bearing pointer options.
- 3) Touch one of the available options or touch **Off**.

COURSE DEVIATION INDICATOR (CDI)

The HSI contains a Course Deviation Indicator (CDI), with a Course Pointer, To/From Indicator, and a sliding deviation bar and scale. The course pointer is a single line arrow (GPS1, VOR1, and LOC1) or a double line arrow (GPS2, VOR2, and LOC2) which points in the direction of the set course. The To/From arrow rotates with the course pointer and is displayed when the active NAVAID is received.

The Course Deviation Indicator (CDI) moves left or right from the course pointer along a lateral deviation scale to display aircraft position relative to the course. If the course deviation data is not valid, the CDI is not displayed.

Another Lateral Deviation Scale and combination Course Deviation and To/From Indicator is optionally located below the slip/skid indicator.

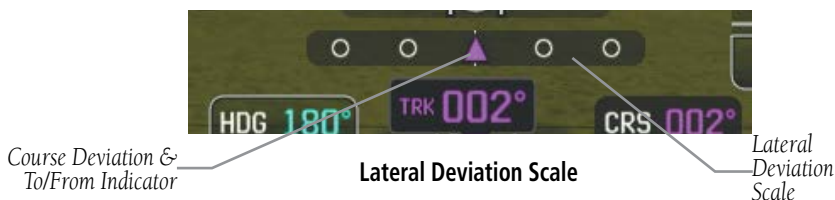

The CDI is capable of displaying two sources of navigation: GPS or NAV (VOR, localizer) depending on the external navigator(s) configured (refer to the G3X Touch Installation Manual for more information). Color indicates the current navigation source: magenta (for GPS) or green (for VOR and LOC). The full-scale limits for the CDI are defined by a GPS-derived distance when coupled to GPS. When coupled to a VOR or localizer (LOC), the CDI has the same angular limits as a mechanical CDI. If the CDI exceeds the maximum deviation on the scale (two dots) while coupled to GPS, the crosstrack error (XTK) is displayed below the white aircraft symbol.

CHANGING THE NAVIGATION SOURCE

Changing the navigation source (GPS, VOR, LOC, or VLOC):



NOTE: On a Standalone MFD, touch 'GPS' in the lower left corner of the touchscreen to switch between 'Internal' and 'External' navigation sources.

Use the associated external navigator to toggle between GPS and VOR/LOC source types. Refer to the appropriate external navigator Pilot's Guide (e.g., SL30 Nav/Comm Transceiver Pilot's Guide, or the GTN™ or GNS™ Series Pilot's Guides) for more information. When an external navigator is configured the internal GPS can still be used for VFR navigation.



NOTE: The G3X Touch internal GPS flight plan is only for VFR use.

- System Overview
- Flight Instruments
- EIS
- CNS Interface
- GPS Navigation
- Flight Planning
- Hazard Avoidance
- Additional Features
- AFCs
- Annun/Alerts
- Appendix
- Index

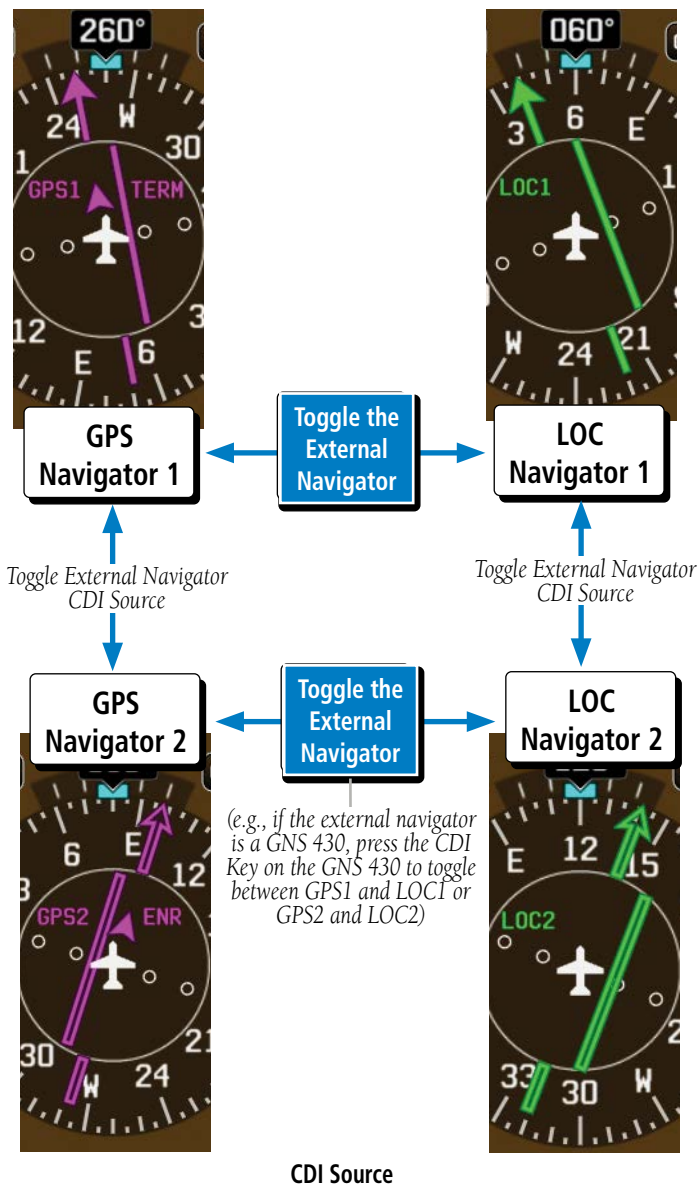

G-METER

Whenever the G load on the airplane goes above +2.1G or below -0.5G, the HSI is temporarily replaced with a large graphical G-meter. To remove the G-meter, touch the displayed **G-meter**. Regardless of the current G load, the HSI can be replaced with a G-meter by changing the 'G METER' setting on the PFD setup page. The G-meter will be displayed until the setting is changed to auto or the power is cycled. Small white triangles are used to indicate the minimum and maximum recorded G loads. When in the auto display mode, the G-meter will automatically be displayed when an unusual attitude is sensed (i.e., greater than +/- 65° roll or +30°/-20° pitch). Refer to the G3X Touch installation manual for more information on configuring the G-meter.

Manually displaying the G-meter:

- 1) With the full screen PFD displayed, press the **MENU** Key.
- 2) Touch **More Options....**
- 3) Touch  in the **G Meter** group to display the G-meter options.
- 4) Touch **On (Replace HSI)**.

Resetting the G-meter minimum and maximum markers:

- 1) With the full screen PFD displayed, or the split screen MFD on a base page, touch the HSI.
- 2) Touch **More Options....**
- 3) Touch **Reset G Meter**.



G-meter

MANUALLY SWITCHING BETWEEN INTERNAL AND EXTERNAL FLIGHT PLAN SOURCES



CAUTION: When switching from a 'external' to a 'internal' flight plan source a loss of information can occur. Information for full approaches, holds, altitude constraints, etc. will be lost. What was once a procedure in the flight plan is converted to a series of waypoints. Additionally, previously curved paths become straight, point-to-point lines.



NOTE: When no external navigator is configured, the system will always operate in 'Internal' flight plan mode.



NOTE: On a Standalone MFD, touch 'GPS' in the lower left corner of the touchscreen to switch between 'Internal' and 'External' navigation sources.

Touch **FPL Source** > **Internal** on the Active Flight Plan Page, to temporarily allow flight planning through the G3X Touch using the internal GPS flight plan when an external GPS Navigator is configured. Touch **FPL Source** > **External GPS** to return to the external GPS navigator's flight plan.

When manually selecting the internal GPS flight plan, 'INT' is displayed in cyan in the lower left quadrant of the HSI. Refer to Section 2.1 'HSI Annunciations' for more information.

FAILURE OF THE EXTERNAL GPS NAVIGATION SOURCE

If the system automatically reverts to using the internal GPS navigation source due to unavailability of the external GPS navigation data, 'REV' is displayed in the lower left quadrant of the HSI and 'VFR' is displayed in the lower right quadrant. In addition, a system status message 'Using internal GPS flight plan for navigation' is displayed.

CDI SCALE SELECTION (INTERNAL GPS ONLY)



NOTE: When an external GPS navigator is in use, the CDI scale is determined by the navigator.

Three factors determine the default distance from the center of the CDI to full left or right limits:

- CDI scale = 1.25 nm - within 30 nm of any airport in the active route.
- CDI scale = 0.25 nm - on an approach leg or within 2 nm of the FAF or MAP.
- CDI scale = 5.0 nm - if the previous two conditions do not exist.



NOTE: *If the CDI scale has been manually adjusted, it will not resume "auto" scale until the auto scale aligns with the manual scale.*

CDI AUTO-SWITCHING

Some external navigators have the ability to automatically switch CDI sources from GPS to VLOC when flying a ILS, LOC, LDA, or SDF approach. This is indicated on the HSI by a change in course pointer color from magenta to green. Additionally, the external navigator may have the ability to automatically switch the LOC course pointer when the CDI source change occurs. Reference the appropriate external navigator documentation for more information.

TURN RATE INDICATOR

The Turn Rate Indicator is located above the HSI. Tick marks to the left and right of the displayed heading denote 1/2 standard turn and standard turn rates (3 deg/sec). A magenta Turn Rate Indicator shows the current turn rate. The end of the trend vector gives the heading predicted in 6 seconds, based on the present turn rate. A standard-rate turn is shown on the indicator by the trend vector stopping at the standard turn rate tick mark, corresponding to a predicted heading of 18° from the current heading. At rates greater than 4 deg/sec, an arrowhead appears at the end of the magenta trend vector and the prediction is no longer valid.

- System Overview
- Flight Instruments
- EIS
- CNS Interface
- GPS Navigation
- Flight Planning
- Hazard Avoidance
- Additional Features
- AFCs
- Annun/Alerts
- Appendix
- Index

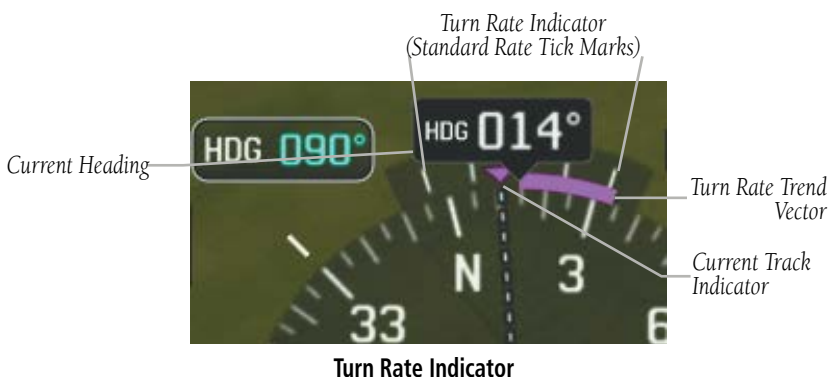

Turn Rate Indicator

OBS MODE



NOTE: If configured, the selected external GPS navigator (i.e., GTN or GNS Series Units) is used to set the OBS Mode.

Enabling Omni-bearing Selector (OBS) Mode suspends the automatic sequencing of waypoints in a GPS flight plan, but retains the current “active-to” waypoint as the navigation reference even after passing the waypoint. ‘OBS’ is annunciated to the left of the aircraft symbol when OBS Mode is selected.

While OBS Mode is enabled, a course line is drawn through the “active-to” waypoint on the moving map. If desired, the course to/from the waypoint can now be adjusted. When OBS Mode is disabled, the GPS flight plan returns to normal operation with automatic sequencing of waypoints, following the course set in OBS Mode. The flight path on the moving map retains the modified course line.

Enabling/disabling OBS Mode (without external GPS navigator):

- 1) While navigating a flight plan or Direct-to, touch **CRS** on the PFD.
- 2) Touch **Yes** on the 'Set OBS and hold?' window.
- 3) Touch **Sync Course** or enter the desired course to/from the waypoint using the keypad and touch **Enter**.
- 4) To cancel OBS Mode and return to automatic waypoint sequencing, touch **OBS** on the PFD.
- 5) Touch **Release OBS Hold**.

Or:

- 1) From the Active Flight Plan Page, press the **MENU** Key
- 2) Touch **Set OBS and Hold**.
- 3) Touch **Sync Course** or enter the desired course to/from the waypoint using the keypad and touch **Enter**.
- 4) To cancel OBS Mode and return to automatic waypoint sequencing, press the **MENU** Key.
- 5) Touch **OBS Course**.
- 6) Touch **Release OBS Hold**.

Adjusting the OBS course:

Press **OBS** on the PFD, enter the desired course using the keypad, and touch **Enter**.

Or:

- 1) If necessary, press the PFD Knob to toggle from Heading to Course.
- 2) Turn the PFD Knob associated with the Course.

VDI PREVIEW

A preview option provides advance indications of approach vertical deviations, allowing the pilot to anticipate changes and make smooth transitions during approach. By default, this function is active.

- VDI Glidepath/Glideslope
- VOR/LOC Course

For ILS and GPS approaches, the VDI provides a preview of glideslope or glidepath deviation.

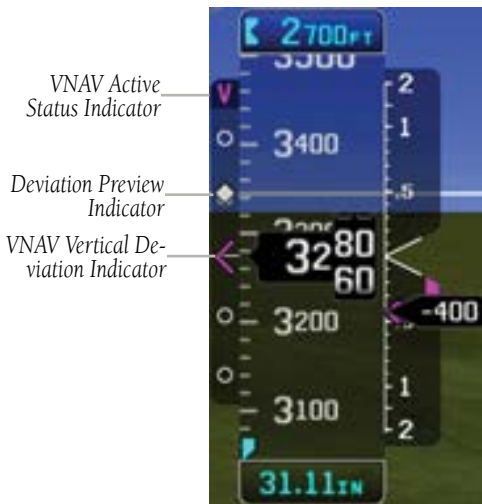

VDI Preview

2.2 SUPPLEMENTAL FLIGHT DATA

In addition to the flight instruments, the PFD also displays various supplemental information, including the Outside Air Temperature (OAT), wind data, and Vertical Navigation (VNAV) indications.

System Overview

Flight Instruments

EIS

CNS Interface

GPS Navigation

Flight Planning

Hazard Avoidance

Additional Features

AFCs

Annun/Alerts

Appendix

Index

OUTSIDE AIR TEMPERATURE

The Outside Air Temperature (OAT) is displayed in degrees Fahrenheit (°F) or degrees Celsius (°C) on the PFD (GDU 470) or on the PFD Status Bar (GDU 460).

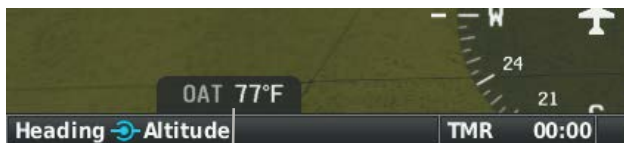

Outside Air Temperature

Outside Air Temperature on PFD (GDU™ 470)



Outside Air Temperature

Outside Air Temperature on PFD Status Bar (GDU 460)

Changing the outside air temperature setting:

- 1) Press the **MENU** Key twice to display the Main Menu.
- 2) Touch **Setup > Units**.
- 3) Touch  in the **Air Temperature** field to display the Air Temperature options.
- 4) Touch **Fahrenheit (°F)** or **Celsius (°C)**.

WIND DATA

Wind direction/speed or headwind/Crosswind information can be displayed in a window to the upper left of the HSI. When the window is selected for display, but wind information is invalid or unavailable, the window displays "No Wind Data".

Showing/hiding wind data:

- 1) From the full-screen PFD, press the **MENU** Key.
- 2) Touch **More Options**.
- 3) Touch  in the **Wind Vector** field to display the Air Temperature options.
- 4) Touch **Speed/Dir, Head/X-wind, or Off**.



Wind Data

USER TIMER

The G3X Touch provides a simple stopwatch for measuring periods of time separately from the Flight Timer. The User Timer can be accessed from the Main Menu or by touching the field labeled 'TMR' in the PFD Status Bar. Additionally, the User Timer can be optionally configured to appear in the Data Bar at the top of all screens.

Using the User Timer:

- 1) From any screen, press the **MENU** key twice.
- 2) Touch **User Timer**.

Or: Touch the **TMR** field, if present, in the Status Bar at the bottom of the display.

Or: Touch the **Timer** field, if present, in the Data Bar at the top of the display.

Touch **Start** to start the Timer. While the Timer is running, the Start button becomes a **Stop** button which pauses the Timer. **Reset** will set the Timer to zero and stop the Timer. Pressing the **Back** Key to close the User Timer box will not interrupt the Timer.



User Timer

User Timer on Status Bar

Adding User Timer to Data Bar:

- 1) From any screen, press the **MENU** key twice.
- 2) Touch **Setup**.
- 3) Touch **Data Bar**.
- 4) Find User Timer Button in the list. Touch  to set the User Timer to **Show On Left**, **Show On Right**, or **Hide**.
- 5) Touch the **Timer** button on the Data Bar to access the User Timer dialog box.

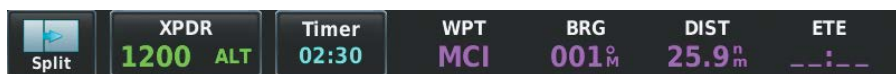

User Timer on Data Bar

ANGLE OF ATTACK (AOA)



CAUTION: The Angle of Attack display and stall warning is for reference only, the aircraft's original stall warning system is the primary means of alerting the pilot of an impending stall. Stall warning AOA may not provide the same alert margin at different flap settings. AOA indication and the stall warning function are only supported for positive G flight.

For G3X Touch installations that include a GAP 26 and a GSU 25, Angle of Attack information can be displayed on the PFD. The GSU 25 uses the pressure from the GAP 26 probe and pitot/static pressures it already receives from the existing aircraft pitot/static system to determine the aircraft's angle of attack (AOA).

Refer to the G3X Touch Installation Manual for the Angle of Attack Calibration procedure. 'During Angle of Attack', 'Stall Warning AOA', 'Caution Alert AOA', 'Minimum Visible AOA', and 'Approach Target AOA' (optional) calibration settings are defined.

When AOA exceeds the calibrated Caution Alert threshold (AOA gauge, an intermittent audible tone will be heard. The tone will increase in frequency until the Stall Warning AOA, when it will play continuously.

When AOA is below the calibrated Minimum Visible AOA threshold, the angle of attack gauge is not displayed.

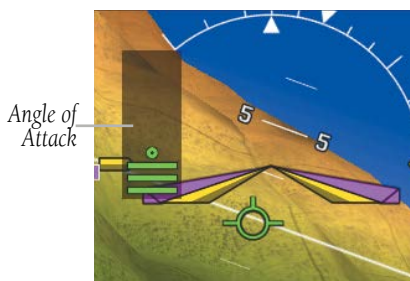

Angle of Attack (AOA)



Angle of Attack Display (AOA)

2.3 VERTICAL NAVIGATION (VNAV)



CAUTION: Internal VNAV is only a VFR navigation aid and is not intended for instrument approaches.



NOTE: The VNAV function may be inhibited when FPL Source is set to 'External' with some external navigators. Refer to the external navigators pilot's guide for more information.

- System Overview
- Flight Instruments
- EIS
- CNS Interface
- GPS Navigation
- Flight Planning
- Hazard Avoidance
- Additional Features
- AFCs
- Annun/Alerts
- Appendix
- Index

The Vertical Navigation Page provides settings for the vertical navigation feature. These settings create a three-dimensional profile from the present location and altitude to a final (target) altitude at a specified location.

When the VNAV profile is defined, the pilot is informed of the progress by message alerts. A magenta chevron (VNAV Indicator) to the left of the altimeter on the Vertical Deviation Scale shows the VNAV profile, and a magenta chevron (Required Vertical Speed Indicator (RVSI)) on the Vertical Speed Indicator indicates the required vertical speed to reach the target altitude.



NOTE: *The Vertical Navigation feature is only available when navigating a Direct-to or flight plan, and the ground speed is greater than 35 knots.*

One minute prior to the initial descent point the “Approaching VNAV Profile” message appears, an aural alert “Vertical Track” is played, and the ‘Estimated Time to VNAV’ (on Active Flight Plan Page) goes blank. The descent angle locks to prevent changes in speed from altering the profile. The VNAV feature does not take into account any changes in ground speed that occur during the transition from level flight to descent.

Approaching VNAV profile

At 200 ft above the target altitude, the “Approaching Target Altitude” message appears, and the VNAV indicator disappears from the PFD.

Approaching VNAV target altitude

System Overview

Flight Instruments

EIS

CNS Interface

GPS Navigation

Flight Planning

Hazard Avoidance

Additional Features

AFCs

Annun/Alerts

Appendix

Index

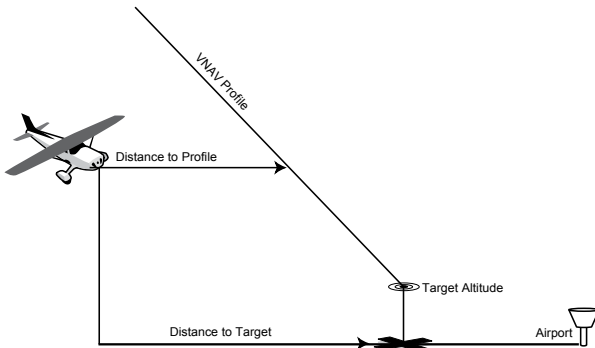

Visual Representation of VNAV

USING THE VNAV FEATURE

Use the VNAV (Vertical Navigation) feature to ensure the aircraft is at the proper altitude. The magenta VNAV Indicator appears on the PFD. A message appears when approaching the VNAV Profile. When the VNAV Indicator is in the vertical center of the Vertical Deviation Scale, the aircraft is at the proper altitude for the VNAV Profile.

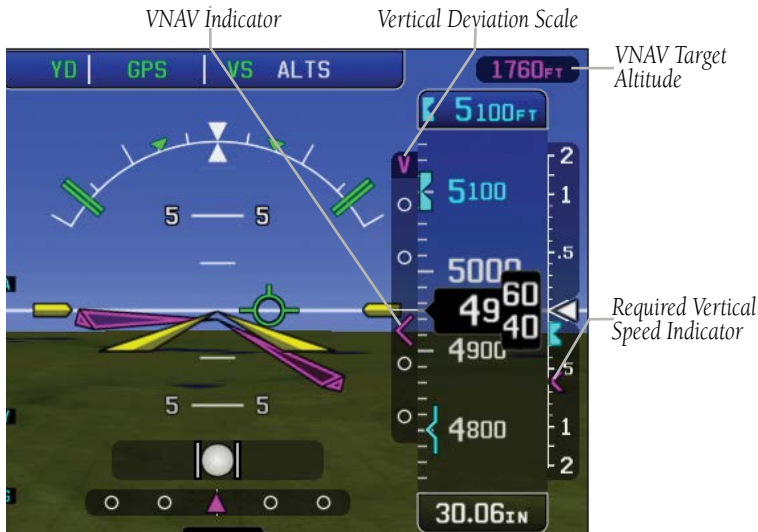

VNAV Indications

Configuring a VNAV profile:

- 1) Press the **MENU** Key twice.
- 2) Touch **VNAV**.
- 3) Touch the **Waypoint** field and choose the desired VNAV waypoint.
- 4) Touch the **Profile** value.
- 5) Enter the desired descent rate in fpm using the keypad and touch **Enter**.
- 6) Touch the **Altitude** value.
- 7) Enter the desired altitude using the keypad and touch **Enter**.
- 8) Touch **Above WPT** or **MSL**.
- 9) Touch the **By** value.
- 10) Enter the desired distance using the keypad and touch **Enter**.
- 11) Touch **Before** or **After**.
- 12) Touch **On** or **Off** to enable or disable VNAV Messages.
 - Waypoint—Enter any waypoint along the currently active route as the reference waypoint. The reference waypoint defines the target location.
 - Profile—Enter the descent rate.
 - Altitude—Enter the desired reference waypoint altitude. Select 'Above Waypoint' to use field elevation for airports in the navigation database or 'MSL' to specify an exact MSL altitude target.



NOTE: *Some waypoints such as intersections do not have an altitude in the database and thus only the VNAV altitude in MSL (not Above Waypoint) may be specified for these waypoints.*

- By—Enter the target location with settings of distance 'Before' or 'After' a reference waypoint. To set a target location at a reference waypoint, enter a distance of zero.
- VNAV Messages—Select 'On' or 'Off' to enable/disable VNAV alert messages.

Forcing capture of the VNAV profile:

- 1) While navigating a flight plan or Direct-to, press the **MENU** Key twice.
- 2) Touch **VNAV** and enter a valid VNAV profile and begin navigation.
- 3) From the Vertical Navigation Page, press the **MENU** Key.
- 4) Touch **Capture VNAV Profile**. Selecting **Capture VNAV Profile** centers the VNAV indicator.

Canceling the VNAV profile:

- 1) While navigating a flight plan or Direct-to with a valid VNAV profile, press the **MENU** Key twice.
- 2) Touch **VNAV**.
- 3) Press the **MENU** Key.
- 4) Touch **Cancel VNAV Profile**.

VNAV PAIRED WITH GTN



NOTE: VNAV mode will not capture a descending profile unless the selected altitude is valid and at least 75 feet below the current aircraft altitude.

Vertical Navigation may also be used on the G3X in concert with a GTN (when equipped). With the G3X Touch and GTN combination, the VNAV flight director mode is designed to be used with vertical guidance for a descent from cruise into an approach or on an arrival. The G3X Touch flight director will typically be in ALT mode prior to intercepting the glideslope or glidepath.

The GTN's VNAV guidance will end prior to the FAF waypoint. Typically, this will result in the flight director capturing the final VNAV target altitude, with the aircraft in a position to subsequently intercept the glidepath. GP mode should be armed prior to intercepting the glidepath. Flight director GPS mode must be active before VNAV mode can be activated. If another lateral mode such as HDG is active, VNAV mode will not be available. VNAV will descend away from the altitude preselector if you are in ALT mode and have VNAV armed.

Setting up GTN for use:

- 1) Boot the associated GTN in configuration mode.
- 2) Select **GTN Setup > Navigation Features > Vertical Navigation**.
- 3) Select **VNAV**.
- 4) Ensure **Transition to Approach** is deselected. When deselected, VNAV guidance will terminate at the waypoint preceding the FAF.



VNAV Configuration



NOTE: Only the GTN Xi displays VNAV TOD (Top of Descent) and BOD (Bottom of Descent) indications on the G3X Touch.

An altitude constraint in the GTN flight plan is necessary to utilize GTN VNAV. Altitude constraints are set and changed only on the GTN by pressing the altitude constraint field next to the waypoint on the flight plan page. This can be verified by looking at the map on the GTN and see the TOD (Top of Descent) indicated on the map (see first image below). As you approach this point, the magenta arrow on the vertical deviation indicator on the PFD will start to come down and the VNAV altitude constraint should be displayed. As you reach TOD, the magenta arrow will center up on the vertical deviation indicator.



Top of Descent Indication (GTN)

Changing VNAV default descent angle:

- 1) From Home screen, select **Utilities**.
- 2) Select **VNAV**.
- 3) Select **Menu** to change the default descent angle.

- System Overview
- Flight Instruments
- EIS
- CNS Interface
- GPS Navigation
- Flight Planning
- Hazard Avoidance
- Additional Features
- AFCS
- Annun/Alerts
- Appendix
- Index

SECTION 3 ENGINE INDICATION SYSTEM

3.1 EIS DISPLAY & ENG PAGE



NOTE: The display of the G3X Touch™ Engine Indication System depends upon the current configuration and may vary from the examples discussed in this section.

The G3X Touch EIS displays engine, electrical, and other system parameters. Additional EIS information can be viewed by selecting the **Eng** Page on the MFD.

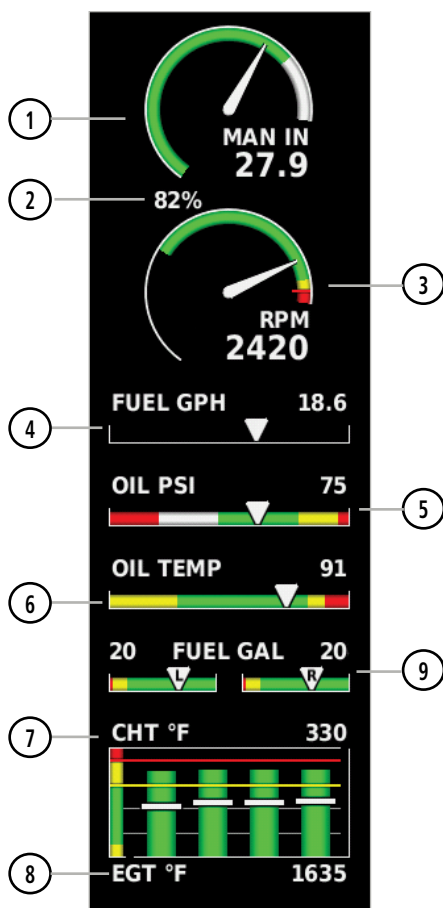

Example Engine Indication System



Example Main Tab on the Eng Page

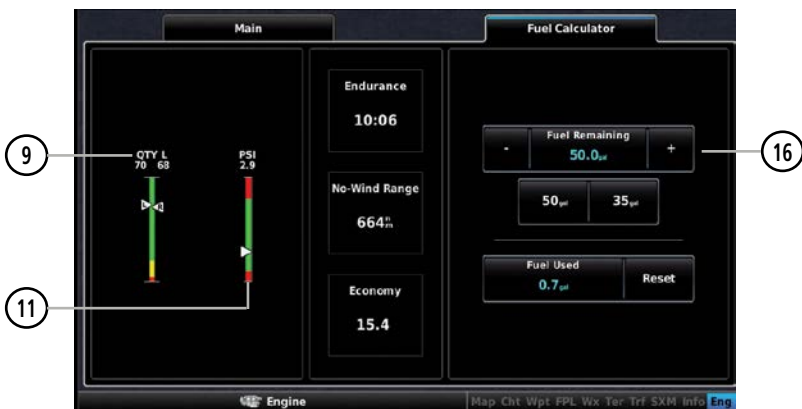

Example Fuel Calculator Tab on the Eng Page

Green bands on the instruments indicate normal ranges of operation; yellow and red bands indicate caution and warning, respectively. When unsafe operating conditions occur, the corresponding caution indication will display solid yellow and the warning indication will flash red. If sensor data to an instrument becomes invalid or unavailable, a red "X" is displayed across the instrument.

- | | | |
|---|----------------------------------|---|
| ① | Engine Manifold Pressure | Displays manifold pressure to indicate engine power |
| ② | Engine Power | Estimated engine power output expressed as a percentage |
| ③ | Tachometer (RPM) | Displays propeller speed in revolutions per minute (rpm) |
| ④ | Fuel Flow | Displays fuel flow |
| ⑤ | Oil Pressure | Displays oil pressure |
| ⑥ | Oil Temperature | Displays oil temperature |
| ⑦ | Cylinder Head Temperature | Displays the cylinder head temperature |
| ⑧ | Exhaust Gas Temperature | Displays the Exhaust Gas Temperature |
| ⑨ | Fuel Quantity | Displays the amount of fuel. Capable of displaying up to four fuel tank readings. |
| ⑩ | Voltmeter | Displays bus voltage |
| ⑪ | Fuel Pressure | Displays fuel pressure |
| ⑫ | Lean Assist | Activates/deactivates Lean Assist (optional) |
| ⑬ | Engine Hours (Tach) | Counted whenever a valid RPM is detected. |
| ⑭ | Ammeter | Displays bus amps |
| ⑮ | Total Hours | Displays aircraft total hours similar to a Hobbs meter |
| ⑯ | Fuel Calculator | Calculates fuel endurance, range, and economy |

3.2 LEAN ASSIST MODE (OPTIONAL)



NOTE: The pilot should follow the engine manufacturer's recommended leaning procedures as described in the Pilot's Operating Handbook (POH).

A **Lean Assist** Button is displayed on the Eng Page when Lean Assist Mode is enabled and at least one Exhaust Gas Temperature (EGT) or Turbine Inlet Temperature (TIT) input is configured (refer to the G3X Touch Installation Manual for more information).

Using Lean Assist Mode:

From the **Main** Tab of the Eng Page, touch **Lean Assist**. As the mixture is leaned, one of the cylinders' exhaust temperature will peak. Continuing to lean the mixture will cause each additional cylinder to peak (if applicable) until the last of the cylinders peaks. To cancel Lean Assist Mode, touch **Lean Assist** again.

When the **Lean Assist** is selected, the Lean Assist Mode waits for a cylinder's EGT to reach a peak temperature and decrease by at least 7°F. To prevent detection of false peaks, the system waits for a cylinder's EGT to increase by at least 15°F before detecting a peak. In addition, if the cylinder temperature rises above a previously detected peak by more than 100°F, the previous peak is considered false.

The following bar graph is displayed when four or more EGT cylinders are configured and the same number of EGT and CHT probes are configured. When each cylinder peaks, its bar changes from green to blue, and the white EGT number changes to a blue delta number. The blue delta number is the difference between current EGT and peak EGT for each cylinder. The first cylinder to peak is identified with a solid blue box around the delta number, and the last cylinder to peak is identified with a hollow blue box. The outline and grey number above each bar displays the actual peak EGT value.

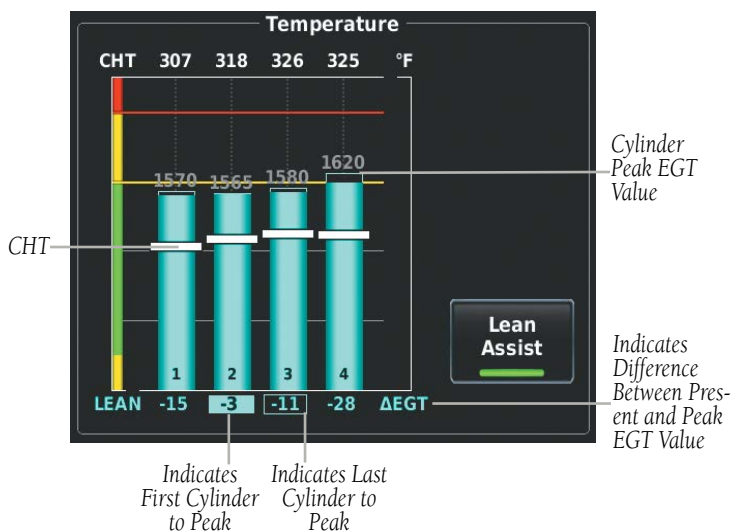

Lean Assist (Same Number Of EGT And CHT Probes Configured And Four Or More Cylinders Configured)

The following graph is displayed if EGT data is configured on less than four cylinders and a different number of EGT and CHT probes are configured. The temperature deviation between the current temperature and the peak temperature for the cylinder currently closest to its peak is displayed in cyan. A cyan hollow triangle appears on the EGT gauge at the temperature where the first cylinder peaked.

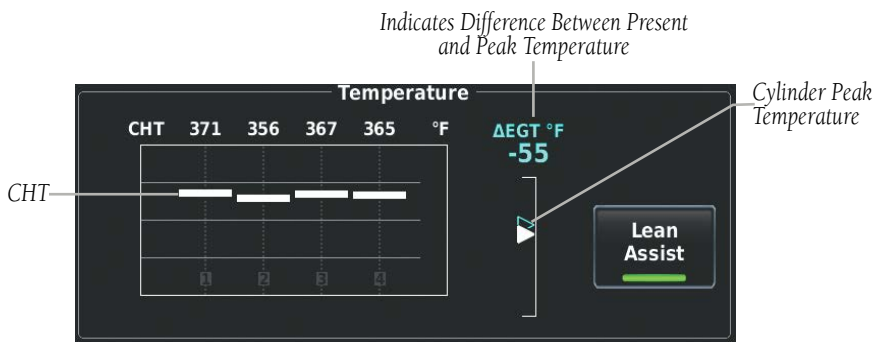

Lean Assist (Different Number Of EGT And CHT Probes Configured And Less Than Four Cylinders Configured)

The following dual-pointer gauge is displayed when exactly two cylinders of EGT are configured. Each cylinder has its own peak temperature triangle.

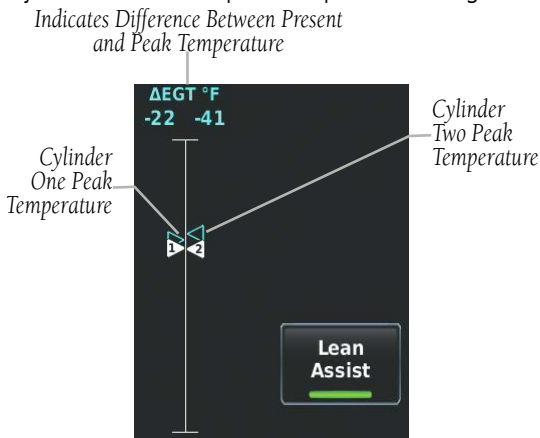

Lean Assist (Two EGT Cylinders Configured)

The following gauge is displayed when TIT is configured instead of EGT.

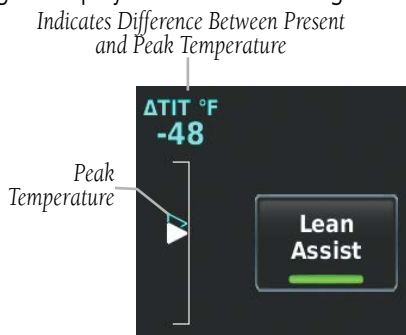

Lean Assist (TIT Configured)



NOTE: A '+' (Δ EGT) value indicates the current temperature is greater than the previously detected peak.

If a fuel flow sensor is configured, the fuel flow value detected as the first cylinder peaks is saved. The fuel flow corresponding to peak EGT is drawn on the fuel flow gauge as a hollow blue pointer. This can be used to determine if you are on the rich side of peak (ROP) or the lean side of peak (LOP). Rich of Peak (ROP) if the fuel flow pointer is above the blue triangle, or Lean of Peak (LOP) if the fuel flow pointer is below the blue triangle.

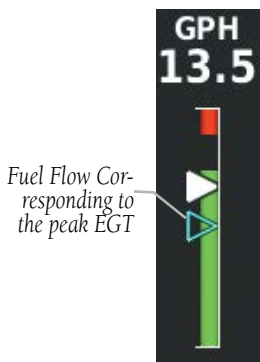

**Fuel Flow Gauge - Lean Assist
(Fuel Flow Sensor Configured)**

The EIS displays the cylinder whose temperature is currently closest to its own peak value (when Lean Assist Mode is active) as a white pointer with the cylinder number. The peak temperature is depicted by a hollow blue pointer, and the temperature deviation from peak (Δ EGT or Δ TIT) is displayed in place of the normal temperature number in cyan text.

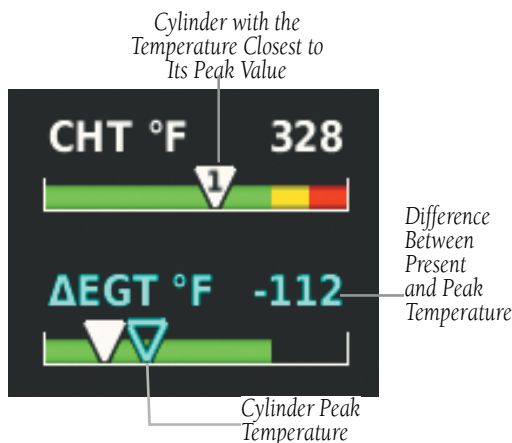

Lean Assist (EIS) (Example)

- System Overview
- Flight Instruments
- EIS**
- CNS Interface
- GPS Navigation
- Flight Planning
- Hazard Avoidance
- Additional Features
- AFCS
- Annun/Alerts
- Appendix
- Index

3.3 FUEL CALCULATOR (OPTIONAL)



WARNING: The G3X Touch Fuel Calculator and/or Fuel Range Rings are NOT intended to be relied upon as the primary fuel indicator(s), and does not relieve the pilot from the responsibility of proper flight planning. G3X Touch fuel calculations do not use the aircraft fuel quantity indicators and are calculated from the last time the fuel was reset.

Refer to the Section 5.2, Using Map Displays, for information on displaying fuel range rings on the Navigation Map.

Adjusting the Fuel Remaining or Fuel Used quantity:

- 1) From the ENG Page, touch the **Fuel Calculator** Tab.
- 2) Touch '+' or '-' to adjust the desired quantity.

Or:

Touch the value to enter the fuel quantity using the keypad and touch **Enter**.

Or:

Touch the pre-configured preset value and touch **Enter**.

Resetting the Fuel Used to zero:

- 1) From the ENG Page, touch the **Fuel Calculator** Tab.
- 2) Touch **Reset**.



Fuel Calculator

3.4 FUEL FLOW CALIBRATION

The K-Factor represents the number of electrical pulses output by the fuel flow sensor per gallon of fuel. Aspects unique to each installation will affect the accuracy of the initial K-Factor, and as a result, the K-Factor must generally be adjusted up or down to increase the accuracy of the fuel flow calibration.

If the fuel usage reported by the G3X Touch differs from the actual fuel usage (as measured at the fuel pump or other trusted method of measurement), the K-Factor can be adjusted either in Configuration Mode (as described in the G3X Touch Installation Manual) or by using the Fuel Flow Calibration Menu in Normal Mode.



NOTE: Do not adjust the Actual Fuel Used unless at least 10 gallons of fuel has been used. The more fuel used, the more accurate the fuel flow calibration adjustment will be.

Adjusting the K-Factor:

- 1) From the ENG Page, touch the **Fuel Calculator** Tab.
- 2) Press the **MENU** Key.
- 3) Touch **Calibrate Fuel Flow**.
- 4) Touch **Actual** to enter the 'Actual' amount of fuel used and touch **Enter**. The system automatically adjusts the K-Factor for the fuel flow sensor to match the observed fuel used.

Once an 'Actual -Fuel Used' value is entered, the corresponding 'Adjustment - Fuel Flow' percentage is displayed. It is also possible to adjust the fuel flow using the 'Adjustment - Fuel Flow' field directly. Entering an adjustment percentage will adjust the 'Actual - Fuel Used' value accordingly. However, this is not the method used to adjust the K-Factor to increase the accuracy of the fuel flow calibration.

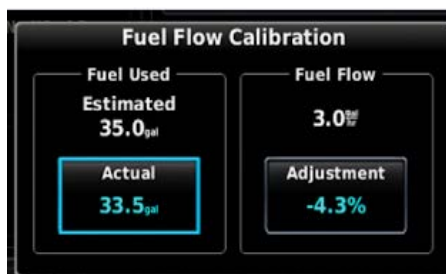

Fuel Flow Calibration

3.5 CAS MESSAGES



NOTE: A standalone MFD does not support CAS messages.

The Crew Alerting System (CAS) messages displayed depend upon the current configuration, and will vary from the examples listed below. Refer to the G3X Touch Installation Manual for more information on configuring CAS messages (if applicable).

CAS Messages are grouped by criticality (warning, caution, advisory). The color of the message is based on its urgency and on required action:

- **WARNING (red):** Requires immediate attention.
- **CAUTION (yellow):** Requires pilot awareness and possible future corrective action.
- **ADVISORY (white):** Provides general information.

Warning annunciation text is shown in red in the CAS Annunciation Window on the PFD. The CAS Annunciation Window location is dependent on screen size. Touch an active CAS message or press the **BACK** Key to acknowledge it.



CAS Warning Example

When more CAS messages are present than can be displayed in the available window space, an upside-down triangle will appear in the CAS Annunciation Window. Touch the CAS Annunciation Window to display the MFD CAS Messages Window.

SECTION 4 CNS INTERFACE (OPTIONAL)

4.1 CNS DATA BAR

The Communication/Navigation/Surveillance (CNS) system includes the audio interface, communication radios, navigation radios, and Mode S transponder. These functions can be accessed from the Main Menu and from the boxes that make up the CNS Data Bar located at the top of the PFD and/or MFD.



CNS Data Bar

- ① **COM1** - Transfers the standby and active COM1 frequencies. *
- ② **STBY** - Displays/removes the COM1 Standby Page. The COM1 Standby Page is used to enter and transfer COM1 frequencies.
- ③ **MIC / COM** - Displays/removes the Audio/Intercom Page.
- ④ **XPDR** - Displays/removes the Transponder Page. The Transponder Page is used to select transponder functions.
- ⑤ **IDENT** - Initiates the transponder Ident function.
- ⑥ **Configurable Data Fields** - See Appendix A for complete list of options.
- ⑦ **COM 2** - Transfers the standby and active COM2 frequencies.
- ⑧ **STBY** - Displays/removes the COM2 Standby Page. The COM2 Standby Page is used to enter and transfer COM2 frequencies.

* When a GMA 342, 345, or 245R is configured, an active COM frequency displayed in green indicates the COM transceiver is selected. If an audio panel is not configured in the system, all COM active frequencies are always displayed in white (since the GDU™ has no knowledge which radio(s) are selected).

4.2 COM ANNUNCIATIONS

When receiving a transmission, 'RX' is displayed on the COM button. 'TX' is also displayed on the COM button while transmitting.



COM Annunciations (TX/RX)

'SQ' is displayed on the COM button when automatic squelch is overridden.



COM Annunciations (SQ)

The frequency monitoring function allows the pilot to listen to the Standby frequency while monitoring the Active frequency for activity.



COM Annunciations (M)

4.3 COM WINDOW

Displaying the COM window:

Touch the **STBY** COM button on the CNS Data Bar.

Or:

From the Main Menu, touch **COM 1 Radio** or **COM 2 Radio** (if configured).



COM Window

Manually tuning a COM frequency:

- 1) Touch **STBY** on CNS Data Bar.
- 2) Enter the frequency using the keypad and touch **Enter**.

Adjusting COM Volume:

- 1) Touch **STBY** on CNS Data Bar.
- 2) Touch **Volume**.
- 3) Touch the slider to adjust the percentage.

Monitoring the Standby COM:

- 1) Touch **STBY** on CNS Data Bar.
- 2) Touch **Monitor**. A green 'M' is displayed in the Standby Field. Repeating steps 1 and 2 will stop monitoring the frequency.

Transferring Standby to Active:

From the CNS Data Bar, touch the COM 1 or COM 2 frequency field.

Or:

- 1) Press the **STBY** on the CNS Data Bar.
- 2) Touch **XFER**.

COM RADIO VOLUME SHORTCUT (GDU™ 460 ONLY)

The Data Bar Setup page can enable a COM Radio Volume Shortcut panel that appears while a COM panel is active. This shortcut panel displays touchscreen controls for volume and toggle on/off squelch for the currently displayed COM radio. The shortcut panel appears at the bottom of the PFD.



COM Radio Volume Level and Squelch Button

COM Radio Volume Shortcut

COM FREQUENCY FINDING

The frequency finding feature allows the pilot to quickly select any displayed database COM frequency as the standby frequency.

Using COM frequency finding:

- 1) Touch COM **STBY** on CNS Data Bar.
- 2) Touch **Find**.
- 3) Touch the **Recent, Nearest Airports**, or **Flight Plan** Tab.
- 4) Touch the frequency or touch **Select Frequency...** for a list of available frequencies.

Or:

- a) Touch **Select an Airport**.
- b) Enter the four letter ICAO identifier for the desired airport.
- c) Touch the frequency.

Or:

- 1) Touch COM **STBY** on CNS Data Bar.

- 2) Touch **Find**.
- 3) Touch the **User** Tab.
- 4) Touch the frequency or touch **Select Frequency...** for a list of available frequencies.

AUTOMATIC SQUELCH

Automatic Squelch quiets unwanted static noise when no audio signal is received, while still providing good sensitivity to weak COM signals. To disable Automatic Squelch, touch **STBY > Squelch**. When Automatic Squelch is disabled, COM audio reception is always on. Continuous static noise may be heard over the headsets and speaker, if selected. Touching **STBY > Squelch** again enables Automatic Squelch.

When Automatic Squelch is disabled, the COM frequency and the Squelch on the COM tuning page is highlighted green.

4.4 COM ERROR MESSAGES

Copilot Push-to-Talk Stuck



COM Error Messages on CNS Bar

The following COM error messages may appear in the COM Radio Field on the CNS Bar:

Message	Description	Action
PILOT PTT STUCK	The Pilot Push To Talk key has been in the pressed position for at least 35 seconds. This key will now be ignored.	Verify Push To Talk key is not stuck. Refer to the installation manual for installation wiring tests. Contact Garmin for service if this message persists.
COPILOT PTT STUCK	The Copilot Push To Talk key has been in the pressed position for at least 35 seconds. This key will now be ignored.	Verify Push To Talk key is not stuck. Refer to the installation manual for installation wiring tests. Contact Garmin for service if this message persists.

BOTH PTT STUCK	Both Push To Talk keys have been in the pressed position for at least 35 seconds. This key will now be ignored.	Verify Push To Talk keys are not stuck. Refer to the installation manual for installation wiring tests. Contact Garmin for service if this message persists.
TX HARDWARE FAULT	An internal hardware problem is preventing COM transmission.	Contact Garmin for service if this message persists.
TEMP TOO HIGH	Internal temperature is too high.	Wait for unit to cool. Add supplemental cooling if problem persists.
SUPPLY VOLTAGE LOW	Supply voltage is too low.	Verify supply voltage meets minimum requirement identified in installation manual. Contact Garmin for service if message persists.

4.5 NAV ANNUNCIATIONS

When NAV ident is enabled, 'ID' is displayed on the NAV button and Morse code tone is played.



NAV Ident Annunciation

4.6 NAV WINDOW

Displaying the NAV window:

Touch the **STBY** NAV button on the CNS Data Bar.

Or:

From the Main Menu, touch **NAV1 Radio** or **NAV 2 Radio** (if configured).

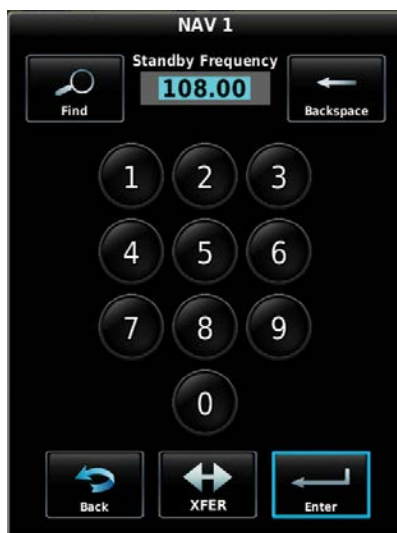

NAV Window

Manually tuning a NAV frequency:

- 1) Touch **STBY** on CNS Data Bar.
- 2) Enter the frequency using the keypad and touch **Enter**.

Transferring Standby to Active:

From the CNS Data Bar, touch the NAV 1 or NAV 2 frequency field.

Or:

- 1) Touch **STBY** on the CNS Data Bar.
- 2) Touch **XFER**.

NAV FREQUENCY FINDING

The frequency finding feature allows the pilot to quickly select any displayed NAV frequency as the standby frequency.

Using NAV frequency finding:

- 1) Touch **STBY** on CNS Data Bar.
- 2) Touch **Find**.
- 3) Touch **Recent, Nearest Navaids, Flight Plan, or User** Tab.
- 4) Touch the frequency or touch **Select Frequency...** for a list of available frequencies.

4.7 NAV ERROR MESSAGES

The following NAV error messages may appear in the NAV Radio Field on the CNS Bar:

Message	Description	Action
VLOC NEEDS SERVICE	The nav radio is reporting that it needs service. The nav radio may continue to function.	Use GPS based navigation. Contact Garmin for service.
VLOC FAIL	The nav radio is not communicating properly with the system.	Use GPS based navigation. Contact Garmin for service.
GS NEEDS SERVICE	The glideslope receiver is indicating that it needs service. The glideslope receiver may continue to function.	Verify glideslope deviation indications with another source and crosscheck final approach fix crossing altitude. If another glideslope source is not available for verification, fly a GPS based approach. Contact Garmin for service.
GS FAIL	The glideslope receiver is not communicating properly with the system.	Fly an approach that does not use the glideslope receiver (VOR, LOC, GPS). Contact Garmin for service.
RMT TRANSFER STUCK	Nav remote transfer key is stuck.	Verify the NAV RMT XFR key/switch is not stuck. Contact Garmin for service if this message persists.

4.8 AUTO-TUNING FREQUENCIES



NOTE: Refer to the G3X Touch™ Installation Manual for more information on the G3X Touch optional communication interfaces.

Frequencies can be automatically tuned from the following:

- Map Page
- Weather Page
- Waypoint Page
- Nearest Airports Page
- Nearest Airport Weather Page
- Nearest Air Traffic Control Page
- Nearest Flight Service Station Page
- Airway Review Page
- Select Approach Page (no external navigator configured)

Auto-tuning a frequency:

- 1) Touch the page navigation bar on the MFD.
- 2) Touch **Waypoint**.
- 3) Touch the waypoint identifier field at the top of the page.
- 4) Enter the desired waypoint and touch **Enter**.
- 5) Touch the **Freq** tab.
- 6) Touch the desired frequency to tune.
- 7) OPTIONAL: Touch the desired COM radio if configured with more than one.



Select COM Radio

Or:

- 1) Touch the page navigation bar on the MFD
- 2) Touch **Map** or **SXM Weather**.
- 3) Touch the desired waypoint or airport on the map.
- 4) Touch the selected waypoint identifier name below the map.
- 5) Touch the **Freq** tab.
- 6) Touch the desired frequency to tune.
- 7) OPTIONAL: Touch the desired COM radio if configured with more than one.

Or:

- 1) Press the **NRST** Key.
- 2) Touch the page navigation bar.
- 3) Touch **Airports**, **Airport Weather**, **VORs**, **ARTCC**, or **FSS**.
- 4) Touch the desired frequency to tune.
- 5) OPTIONAL: Touch the desired COM radio if configured with more than one.

Or:

- 1) Press the **NRST** Key.
- 2) Touch the page navigation bar.
- 3) Touch **Airspace**.
- 4) Touch the desired airspace.
- 5) Touch **Frequencies**.
- 6) Touch the desired frequency to tune.
- 7) OPTIONAL: Touch the desired COM radio if configured with more than one.

4.9 USER FREQUENCIES

Adding a User Frequency:

- 1) Touch **STBY** on CNS Data Bar.
- 2) Touch **Find**.
- 3) Touch the **User** Tab.
- 4) Touch **Edit User Frequencies**.
- 5) Touch **Add User Frequency**.

- 6) Touch **Name** or **Frequency**.
- 7) Enter the name/frequency using the keypad and touch **Enter**.

Editing a User Frequency:

- 1) Touch **STBY** on CNS Data Bar.
- 2) Touch **Find**.
- 3) Touch the **User** Tab.
- 4) Touch **Edit User Frequencies**.
- 5) Touch the Name or Frequency to edit.
- 6) Enter the name/frequency using the keypad and touch **Enter**.

Deleting a User Frequency:

- 1) Touch **STBY** on CNS Data Bar.
- 2) Touch **Find**.
- 3) Touch the **User** Tab.
- 4) Touch **Edit User Frequencies**.
- 5) Touch **Delete**.
- 6) Touch **Yes**.

4.10 AUDIO PANEL



NOTE: *The audio panel information in this section pertains only to G3X systems configured with a GMA 245R. Screenshots and descriptions may differ from actual display function depending upon configuration.*

When configured with a compatible audio panel, touching the Audio Box on the CNS Data Bar will display the Audio/Intercom Page. The Audio/Intercom Page allows selection of four separate tabs, these are the Radios, Intercom, Phone & Media, and Music Input tabs. The Audio Box can be configured for Normal or Minimized display format, (Audio Only format may be displayed as determined by available space on the CNS Data Bar).

- System Overview
- Flight Instruments
- EIS
- CNS Interface**
- GPS Navigation
- Flight Planning
- Hazard Avoidance
- Additional Features
- AFCs
- Annun/Alerts
- Appendix
- Index

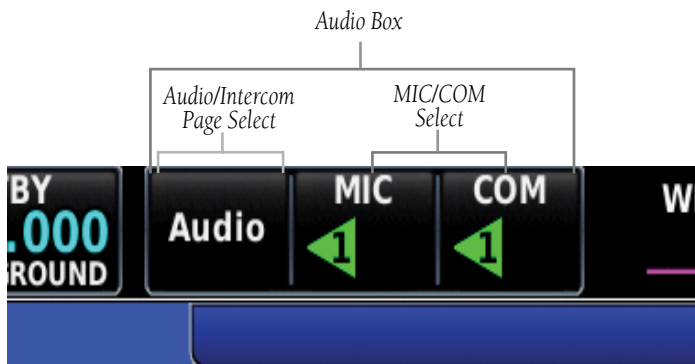

Audio Box on CNS Data Bar

There are three different formats of the Audio Box that may be displayed:





Audio Box Format	Description
	Normal - Provides access to the Audio/Intercom Page and MIC/COM settings.
	Minimized - Provides access to the Audio/Intercom Page and displays the current MIC/COM settings (cannot change the MIC/COM settings in this format)
	Audio Only - Provides access to the Audio/Intercom Page. Displayed only when COM 2 is disabled via the audio panel configuration, or there's not enough room for the Minimized control to be displayed.

The preceding examples all indicate that no Bluetooth phone call is in progress. When a phone call is incoming or in progress, a "TEL" indicator is displayed (flashing to indicate incoming call, non-flashing to indicate call is active), see Phone & Media Tab section for more information.

Note the Audio Box can be configured to display square or triangle indicators.



Several status indications can be selected/shown in the Audio Box per the following table.

Audio Box (Normal)	Description
	MIC 1 selected, monitoring COM 1
	MIC 2 selected, monitoring COM 2
	MIC 1 selected, monitoring COM 1 and COM 2
	MIC 2 selected, monitoring COM 1 and COM 2
	Split COM selected. Isolates the COM 1 radio to the pilot and the COM 2 radio to the copilot.

AUDIO/INTERCOM PAGE

Selecting Audio/Intercom Page

Touch **Audio** on the CNS Data Bar.

Or:

- 1) Press the **MENU** Key twice.
- 2) Touch the **Audio Panel** button to display the Audio/Intercom Page.

RADIOS TAB

The following paragraphs describe the functions accessible from the Radios Tab.

Selecting the Radios tab:

- 1) Touch **Audio** on the CNS Data Bar.
- 2) Touch the **Radios** tab (if needed.)

Or:

- 1) Press the **MENU** Key twice.
- 2) Touch the **Audio Panel** button to display the Audio/Intercom Page.
- 3) Touch the **Radios** tab (if needed.)



Audio/Intercom Page, Radios Tab

Selecting the Monitored Radio:

Touch the 'Audio' **COM** button on the CNS Data Bar to select/deselect a monitored radio.

Or:

From the Main Menu, touch **Audio Panel** > **Radios** Tab and touch the desired COM radios.

Selecting the Radio to transmit from:

Touch the **MIC** box on the CNS Data Bar to change the radio used to transmit (talk) from.

Or:

From the Main Menu, touch **Audio Panel** > **Radios** Tab and touch the desired COM MIC radios.

Selecting/Deselecting Split COM mode:

- 1) Touch **Audio** on the CNS Data Bar.

Or:

From the Main Menu, touch **Audio Panel**.

- 2) Touch the **Radios** tab if needed.
- 3) Touch the **Split COM** button to select (green) or deselect Split COM mode.

COM RADIOS

The COM 1/COM 2 buttons select the monitored radio. The COM 1 MIC/COM 2 MIC buttons selects the radio used to transmit from.

Selecting "Split COM" overrides the current MIC/COM selections and enables MIC1/COM1 for the pilot, and MIC2/COM2 for the copilot (i.e., "Split COM" isolates the COM 1 radio to the pilot and the COM 2 radio to the copilot).

MARKER BEACON

The marker beacon receiver is used as part of the ILS. The marker beacon receiver is always on and detects any marker beacon signals within the reception range of the aircraft. The receiver detects the three tones - outer, middle, and inner - and illuminates the marker beacon annunciations located to the left of the altimeter on the PFD.

Touch **Marker Beacon** on the Audio/Intercom Page (Radios Tab) to select/deselect the marker beacon audio. The **Marker Beacon** Button annunciator indicates when marker beacon audio is selected.



NOTE: *The Speaker Button is moved under 'More Options...' when both Marker Beacon and Speaker are enabled.*



Marker Beacon Audio

Touch **Marker Sensitivity** on the Audio/Intercom Page (Radios Tab) > **More Options...** to switch between **High** and **Low** marker beacon receiver sensitivity. **High** is used to provide an earlier indication when nearing a marker during an approach. **Low** results in a narrower marker dwell while over a station.

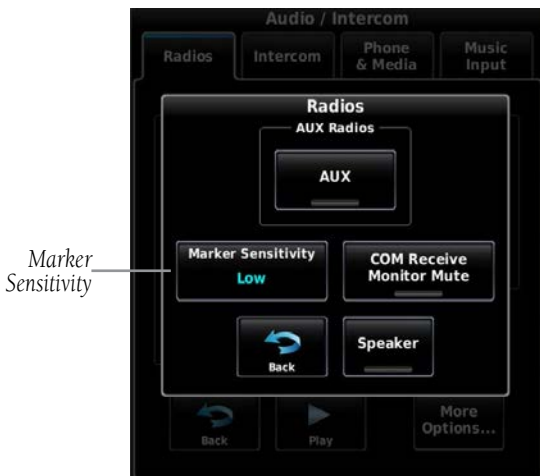

Marker Sensitivity (Radios Tab > More Options)

SPEAKER

The Speaker function enables audio to be played through a connected speaker. Alert audio is always played over the speaker, regardless of the speaker button state.

PLAY BUTTON

This button is used to play back the last received radio transmission(s), and is not associated with audio/video.

- The playback recording is only for the mic selected radio.
- Pressing the play button again while a recording is playing skips that recording and starts playing the previous recording. After repeatedly pressing this button until all recordings have been played, a double-beep will sound and the playback will reset to the start. The playback function also resets to the start after listening to a selected recording.
- The playback function retains approximately the last 60 seconds of received audio from the MIC selected COM radio.

- System Overview
- Flight Instruments
- EIS
- CNS Interface
- GPS Navigation
- Flight Planning
- Hazard Avoidance
- Additional Features
- AFCS
- Annun/Alerts
- Appendix
- Index

VOLUME SHORTCUT (GDU 460 ONLY)

The Data Bar Setup page can enable a Volume Shortcut panel that appears while the Audio/Intercom panel is active. This shortcut panel displays touchscreen volume controls for pilot and copilot intercom, music, and Bluetooth audio. When a tab in the Audio/Intercom panel is selected, the Volume Shortcut panel changes to the volume controls for that source - i.e., when the Phone & Media tab is selected, the Volume Shortcut panel adjusts the volume for the Bluetooth audio. The shortcut panel's source can also be changed by pressing either of the knobs. The shortcut panel appears on the opposite side of the screen as the Audio/Intercom panel.



Pilot and Copilot Intercom Volume Levels

Audio Intercom Volume Shortcut (GDU™ 460 only)

MORE OPTIONS



NOTE: The Speaker Button is moved under 'More Options...' when both Marker Beacon and Speaker are enabled.

The **More Options...** Button allows access to the AUX Radios, Marker Sensitivity, and Active COM Receive Monitor Mute functions. Selecting Monitor Mute, mutes the monitored COM radio when audio from the MIC selected COM radio is heard.



Radios Tab, More Options Button Selected

INTERCOM TAB

The following paragraphs describe the functions accessible from the Intercom Tab.

Selecting the Intercom tab:

- 1) Touch **Audio** on the CNS Data Bar.

Or:

From the Main Menu, touch **Audio Panel**.

- 2) Touch the **Intercom** tab.

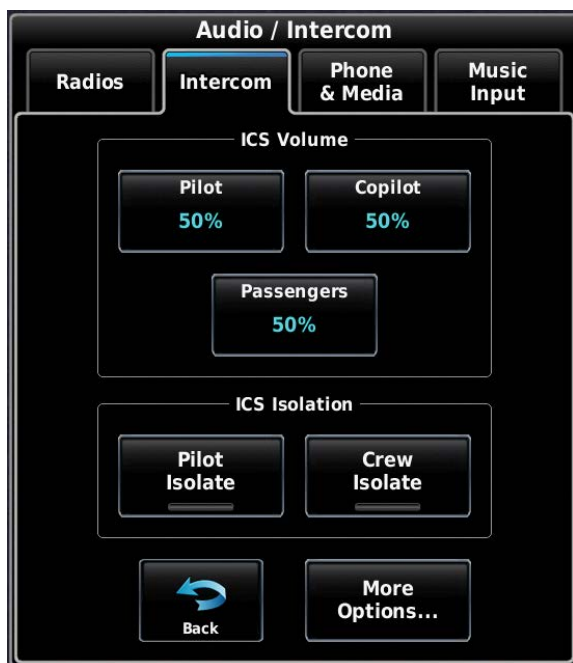

Audio/Intercom Page, Intercom Tab

ICS VOLUME

The ICS Volume section allows selection of Pilot, Copilot, and Passenger intercom volume. A volume adjust slider is used to set the selected volume on G3X Touch systems with a GMA 245R.

Adjusting Volume:

- 1) Touch **Pilot, Copilot, or Passengers** on Intercom Tab.
- 2) Touch the slider to adjust the percentage.

ICS ISOLATION

The ICS Isolation section allows selection of Pilot and Crew Isolate functions. These functions are annunciated in the Audio Box on the CNS Data Bar when active.

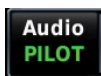

Pilot Isolation mode isolates the Pilot from other ICS positions (Copilot and Passengers). The Copilot and Passengers share communication between themselves but cannot communicate with the Pilot or hear the pilot's selected radios.

Crew Isolation mode places the Pilot and Copilot on a common ICS communication channel. The Passengers are on their own intercom channel and can communicate with each other, but cannot communicate with the Pilot and Copilot or hear the pilot's selected radios.

MORE OPTIONS...

The More Options button allows access to the 3D Audio and Muting functions.

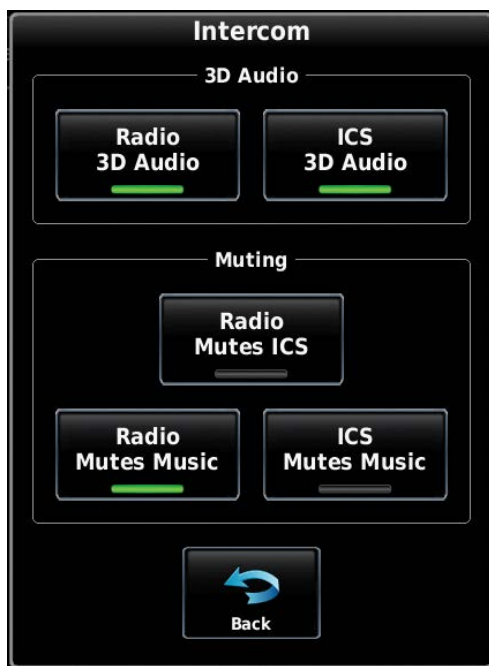

Intercom Tab, More Options Button Selected

- System Overview
- Flight Instruments
- EIS
- CNS Interface
- GPS Navigation
- Flight Planning
- Hazard Avoidance
- Additional Features
- AFCS
- Annun/Alerts
- Appendix
- Index

3D AUDIO

3D Audio is useful when multiple audio sources are present. 3D audio processing creates the illusion that each audio source is coming from a unique location or seat position by using different responses in each ear. Because this feature uses different signals for left and right channels, it requires wiring for stereo intercom and stereo headsets. If 3D audio is activated when mono headsets are in use, the listener will still hear all audio sources; however, there is no benefit from location separation. With a single COM selected and Radio 3D Audio enabled, the listener hears the audio source at the 12 o'clock position. If both COMs are selected, the listener hears COM1 at 11 o'clock and COM2 at the 1 o'clock position. When ICS 3D Audio is selected, all intercom positions are processed to sound like their relative seat location. By default, the GMA 245R assumes the pilot sits in the left seat.

Selecting Radio/ICS 3D Audio:

- 1) Touch **More Options** button on the Intercom tab.
- 2) Touch the **Radio 3D Audio** or **ICS 3D Audio** button to select/deselect the desired 3D Audio function.

MUTING

- Radio Mutes ICS – When Radio Mutes ICS is enabled, intercom audio from passengers to crew is muted when audio from the COM selected for transmission is heard.
- Radio Mutes Music – When Radio Mutes Music is enabled, music audio is muted when radio audio is heard.
- ICS Mutes Music – When ICS Mutes Music is enabled, music audio is muted when intercom audio is heard.

PHONE & MEDIA TAB

Selecting the Phone & Media tab:

- 1) Touch **Audio** on the CNS Data Bar.
Or:
From the Main Menu, touch **Audio Panel**.
- 2) Touch the **Phone & Media** tab.

The Phone & Media Tab on the Audio-Intercom Page, provides access to the telephone controls, enables media playback, and connects to a Bluetooth device.

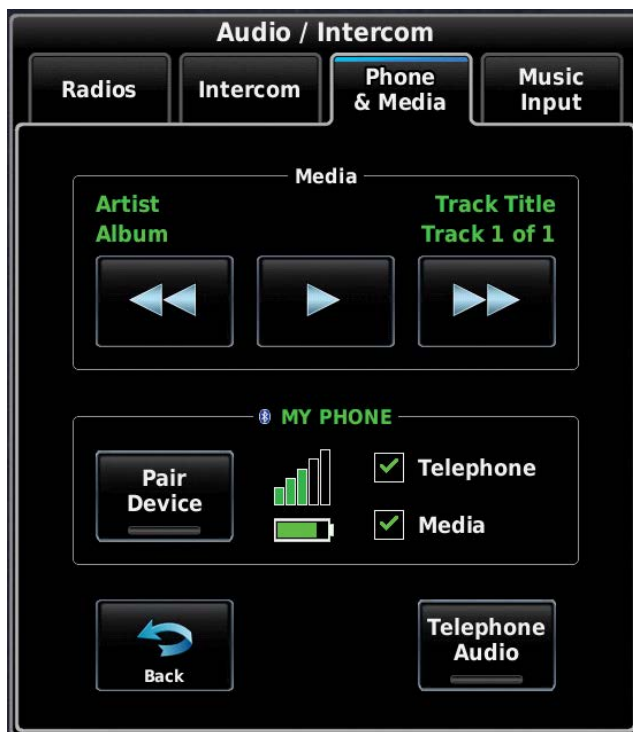

Audio/Intercom Page, Phone & Media Tab

MEDIA

The Media Controls enable playback of the current media (i.e., music, movie, etc.). The buttons are subdued when media is unavailable.



Media Controls

BLUETOOTH

The Bluetooth “Pair Device” button with a toggle indicates when the “pairing mode” is currently active. Pressing this button initiates the pairing operation and indicates when pairing is in progress. The toggle is displayed as green until the GMA reports that pairing mode is no longer active. When pairing is not allowed, pressing this button performs no action.

When pairing mode is enabled, the GMA 245R is able to be paired to other Bluetooth enabled devices. Refer to the device's user manual for instructions on how to pair to a Bluetooth device. The GMA 245R will remember the ten most recently paired devices, if the list is full and a new device is paired, the device with the oldest connection date/time is removed from the list.

The GMA 245R supports Bluetooth wireless delivery of pilot headphone audio to versions of the Garmin VIRB action camera that support Bluetooth mic audio input for recording.



Pairing a Garmin VIRB to the GMA 245R works like pairing other Bluetooth audio devices. Once connected, pilot headphone audio will be delivered to the VIRB via Bluetooth. In a connection to the Garmin VIRB, the GMA is the source. Therefore, selecting an entertainment key is not required.

BLUETOOTH CONNECTION STATUS

The Bluetooth connection status is either displayed with a single checkbox for “No Connection”, or with 1 or 2 checkboxes for each item connected (i.e., a single checkbox for media only, phone only, and output only, or 2 checkboxes for media and phone, or media and output).

Bluetooth/Media Indication	Description
	<p>No Bluetooth connection, pairing mode disabled.</p>
	<p>No Bluetooth connection, pairing mode enabled.</p>
	<p>Bluetooth is connected with a VIRB Action camera that supports Bluetooth audio.</p>
	<p>Bluetooth is connected with telephone and media functions. When connected to the telephone, the Bluetooth title is replaced with the phone's ID (if provided by phone).</p>

- System Overview
- Flight Instruments
- EIS
- CNS Interface
- GPS Navigation
- Flight Planning
- Hazard Avoidance
- Additional Features
- AFCs
- Annun/Alerts
- Appendix
- Index

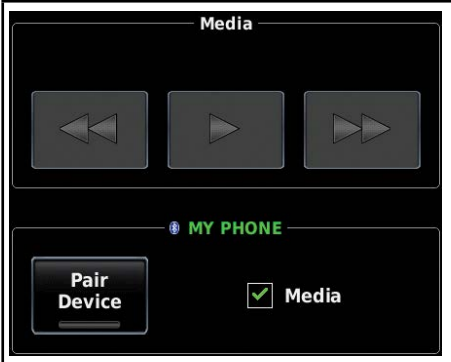
Bluetooth/Media Indication	Description
 <p>The screenshot shows a 'Media' screen with three playback buttons (previous, play/pause, next) at the top. Below them is a 'MY PHONE' status indicator with a signal strength bar and a battery icon. At the bottom, there is a 'Pair Device' button and a checked 'Telephone' checkbox.</p>	<p>Bluetooth is connected with telephone function only.</p>
 <p>The screenshot shows an 'Audio / Intercom' screen with four tabs: 'Radios', 'Intercom', 'Phone & Media', and 'Music Input'. The 'Phone & Media' tab is selected. Below the tabs, there is a 'Media' section displaying 'Artist Album' and 'Track Title Track 1 of 1'. Playback controls (previous, play/pause, next) are visible, with the play/pause button highlighted in blue.</p>	<p>Bluetooth is connected with media functions only.</p>
 <p>The screenshot shows a 'Media' screen with three playback buttons (previous, play/pause, next) at the top. Below them is a 'MY PHONE' status indicator with a signal strength bar and a battery icon. At the bottom, there is a 'Pair Device' button and a checked 'Media' checkbox.</p>	<p>Bluetooth is connected with media, but the connected device does not support media controls. In this instance, the media controls are disabled. The audio is audible via the intercom but may only be controlled via the external device.</p>

- System Overview
- Flight Instruments
- EIS
- CNS Interface
- GPS Navigation
- Flight Planning
- Hazard Avoidance
- Additional Features
- AFCs
- Annun/Alerts
- Appendix
- Index

Bluetooth/Media Indication	Description
	<p>When the audio is playing with the media controls enabled, the Play button is replaced with the Pause button. If provided by the external device, the album/artist/title/track number is displayed above the media controls. The external device may provide all, none, or only a part of this information.</p>
	<p>Bluetooth interface is disabled. The GMA's Bluetooth interface may be enabled/disabled as described below.</p>

DISABLING BLUETOOTH ON GMA 245R

To aid in troubleshooting, the G3X Touch can be used to disable the Bluetooth functionality on the GMA 245R devices. Bluetooth on the GMA 245R can be re-enabled with the same process as disabling it. The GMA 245R will also re-enable Bluetooth when the power is cycled.

Enabling/disabling GMA 245R Bluetooth:



- 1) Press the **MENU** Key twice.
- 2) Touch the **Audio Panel** button to display the Audio/Intercom Page.
- 3) Touch the **Phone & Media** tab.
- 4) Press the **MENU** Key.
- 5) Touch **Disable/Enable**.

TELEPHONE OPERATIONS

When the Bluetooth connection status indicates “Telephone” is connected, the Phone & Media Tab on the Audio/Intercom Page provides the ability to answer, ignore (do not answer), and end Bluetooth phone calls and the Data Bar’s audio panel controls provide indications of the status of a Bluetooth phone call.

TELEPHONE AUDIO

The Telephone Audio button allows enables/disables the telephone's audio to the intercom system for both the wired and Bluetooth telephone connections.

Button Status	Description	Connection Description
 Enabled (Green)	Telephone audio is active (i.e., connected to the intercom).	Wired Connection: The audio of the telephone is connected to the intercom and the pilot may participate in existing calls. Controlling the call (i.e., answer/hang up) is not supported, the ringing of an incoming call may be heard but the actual phone must be used to answer (and end) the call.
		Bluetooth Connection: The ringing of an incoming call may be heard via the intercom, and the pilot may ignore/answer/end the call via the provided GDU controls.
 Disabled (Gray)	Telephone audio is not active (i.e., connected to the intercom).	Wired Connection: Telephone operations are not supported via the intercom, and there are no indications of incoming or existing calls.
		Bluetooth Connection: The ringing of an incoming call and the audio of an existing call are not heard via the intercom. The GDU provides an indication of an incoming call via the Data Bar's audio panel button (flashing "TEL" indicator) and the Audio Panel page to allow the pilot to answer it - which automatically transitions "Telephone Audio" to enabled. Also, the Audio Panel page provides an indication of an existing call (via "Call Active") allowing the pilot to join in the call via the intercom by enabling "Telephone Audio".

TELEPHONE DATA BAR CONTROLS

To provide an immediate indication of the state of a Bluetooth phone call at all times (without having to access the Audio/Intercom page), the Audio Box on the Data Bar provides the status of a Bluetooth phone call to indicate:

- No call is active
- A call is incoming (i.e., phone is ringing)
- A call is active

These controls also display the intercom isolation states per the following table.

Audio Box Format			Description
Normal	Minimized	Audio Only	
			Call active, no intercom isolation
			Call active, with intercom isolation

Touch Audio on the Data Bar when a Bluetooth phone call is “incoming” or “active” to directly access the Phone/Media tab on the Audio/Intercom page and provide instant access to the phone controls.

- System Overview
- Flight Instruments
- EIS
- CNS Interface
- GPS Navigation
- Flight Planning
- Hazard Avoidance
- Additional Features
- AFCS
- Annun/Alerts
- Appendix
- Index

TELEPHONE CONTROLS

The Phone & Media Tab on the Audio/Intercom Page provides the ability to answer, ignore (i.e., do not answer), and end Bluetooth phone calls.

At the top of the tab, the Media title and controls are replaced with the phone call status and controls. The "Media" title is replaced with "Incoming Call" or "Call Active" and the media buttons are replaced with the phone's call volume control and the ability to set the external device's phone volume and ignore/answer/end the call.

Also, the caller's phone number is displayed above the phone controls if provided by the external device.

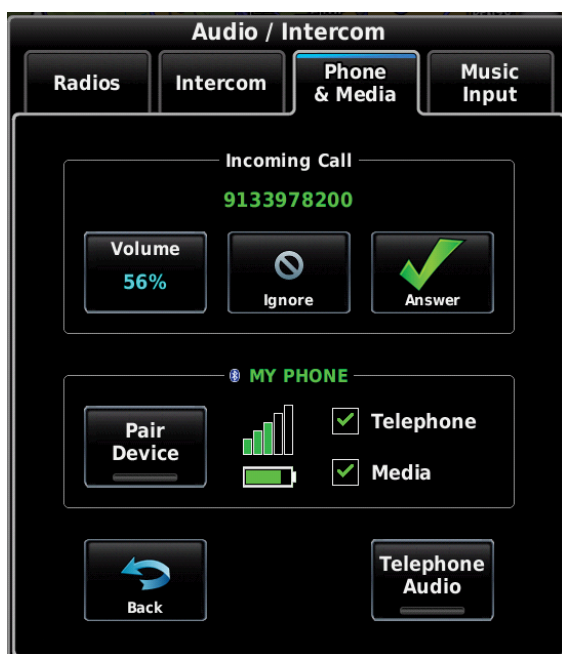

Incoming Call (Phone is Ringing)

- System Overview
- Flight Instruments
- EIS
- CNS Interface**
- GPS Navigation
- Flight Planning
- Hazard Avoidance
- Additional Features
- AFCs
- Annun/Alerts
- Appendix
- Index



Active Call (Call is in Progress)



Telephone Volume Slider

MUSIC INPUT TAB

The following paragraphs describe the functions accessible from the Music Input Tab.

Selecting the Music Input tab:

- 1) Touch **Audio** on the CNS Data Bar.
Or:
 From the Main Menu, touch **Audio Panel**.
- 2) Touch the **Music Input** tab.



Audio/Intercom Page, Music Input Tab

PILOT MUSIC/COPILOT MUSIC/PASSENGERS MUSIC

These buttons enable/disable the individual music source for the separate intercom stations. The supported music sources are two (wired) inputs and one (wireless) Bluetooth input. Note the Source names for the Music 1 and Music 2 (wired) inputs are defined in configuration mode (SXM, DVD, etc., as shown in preceding figure), the Bluetooth input Source name is Bluetooth and cannot be changed.

Selecting Source:

- 1) Touch **Source** for Pilot, Copilot, or Passengers on Music Input Tab.
- 2) Touch **Music 1, Music 2, or Bluetooth** to select the audio source.

Adjusting Volume:

A volume adjust slider is used to set the selected volume on G3X Touch systems with a GMA 245R.

- 1) Touch **Volume** for Pilot, Copilot, or Passengers on Music Input Tab (**Volume** is displayed for Pilot or Copilot for GMA 245R units only).
- 2) Touch the slider to adjust the percentage.

MUSIC DISTRIBUTION

Selecting Normal using the Distribution button overrides the individual music controls for the copilot and passengers intercom stations. Normal sets all music selections (enable/disable, source, and volume) for the specified intercom station to the same settings as the currently selected pilot settings. With Normal selected, the system behaves as if it has only a single music interface.

The Advanced selection allows the individual selection of separate music interfaces for pilot, copilot, and passengers.

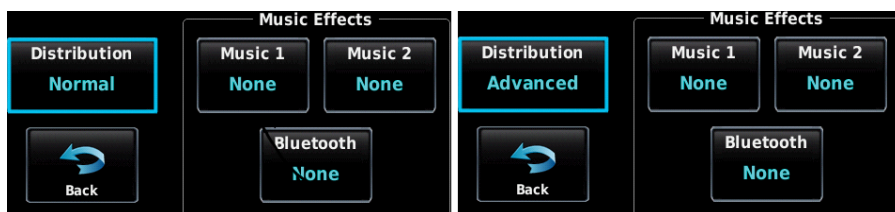

Distribution Button Selections

MUSIC EFFECTS

The Music 1, Music 2, and Bluetooth sections have music effect selections as follows:

- Bass Boost - Available settings are None, Medium, and High
- Equalizer - Available settings are None, Rock, Classical, and Pop

4.11 REMOTE TRANSPONDER INTERFACE (OPTIONAL)

The G3X Touch is capable of interfacing with several remote transponders providing Mode S interrogation and reply capabilities. Selective addressing or Mode Select (Mode S) capability includes the following features:

- Level-2 reply data link capability (used to exchange information between aircraft and ATC facilities)
- Surveillance identifier capability
- Flight ID (Flight Identification) reporting - The Mode S Transponder reports identification as either the aircraft registration or a unique Flight ID.
- Altitude Reporting
- Airborne status determination
- Transponder capability reporting
- Mode S Enhanced Surveillance (EHS) requirements
- Acquisition squitter - Acquisition squitter, or short squitter, is the transponder 24 bit identification address. The transmission is sent periodically, regardless of the presence of interrogations. The purpose of the acquisition squitter is to enable Mode S ground stations and aircraft equipped with a Traffic Avoidance System (TAS) to recognize the presence of Mode S-equipped aircraft for selective interrogation.

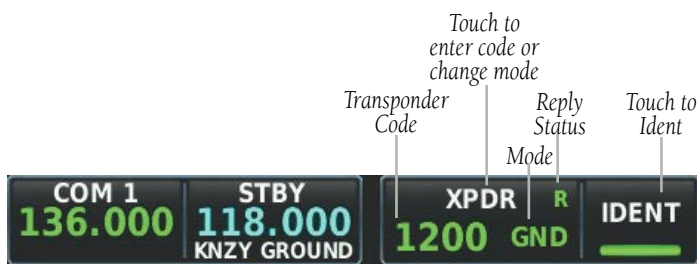

Transponder Data Box on CNS Bar

Transponder tuning for panel mount transponders like GTX 327 (Mode C) is also supported.



NOTE: A standalone MFD cannot support the remote transponder interface.

TRANSPONDER CODE AND MODE SELECTION

The transponder mode will automatically switch between GND Mode and ALT Mode.

Selecting a transponder code or mode:

- 1) Touch the transponder data box on the PFD.

Or:

From the Main Menu, touch **XPDR**.

- 2) Use the keypad to enter a code and touch **Enter**.

Or:

Touch **STBY**, **GND/ALT**, or **ON** to change the mode, and touch **Enter**.



Transponder Code, Mode, and Flight ID Entry

GROUND AND ALTITUDE MODES



NOTE: To facilitate formation flights, a transponder can be manually placed in STBY mode prior to takeoff and it will not automatically change to ALT mode upon transition to in-air state.

Most Garmin transponders automatically transition between on-ground and in-air and operate in the appropriate mode at all times. No pilot action is required to manage modes unless there is a need to manually select STBY or ON modes.

The G3X Touch displays a green GND indication and transponder code in the Transponder Data Box while on-ground, and a green ALT indication when in-air, when not set to STBY or ON.



NOTE: Some panel mount transponders may indicate ALT on their dedicated display at all time, even while on-ground. As a result, in some installations, the transponder display and the G3X Touch display will indicate different modes while on the ground, although they are functionally equivalent.

STANDBY MODE (MANUAL)

In Standby Mode, the transponder does not reply to interrogations, but new codes can be entered. When Standby Mode is selected, a white STBY indication and transponder code appear in the Transponder Data Box.

ON MODE (MANUAL)

On Mode can be selected at any time. ON Mode generates Mode A and Mode S replies, but Mode C altitude reporting is inhibited. In ON Mode, a green ON indication and transponder code appear in the Transponder Data Box.

REPLY STATUS

When the transponder sends replies to interrogations, a green R indication appears momentarily in the Transponder Data Box.

VFR CODE

The VFR code can be entered either manually or by touching **VFR** on the Transponder Page. The pre-programmed VFR code is automatically displayed in the code field of the Transponder Data Box.

IDENT FUNCTION

Touching **IDENT** sends a distinct identity indication to Air Traffic Control (ATC). The indication distinguishes the identifying transponder from all the others on the air traffic controller's screen. After touching **IDENT** the bar on the button turns green momentarily.

ADS-B OUT

When configured with an ADS-B Out capable transponder, '**NO ADSB**' is displayed in yellow, in the Transponder Data Box, if the ADS-B Out broadcast has been manually disabled or if the transponder does not have the required GPS data.

FLIGHT ID REPORTING



NOTE: The Flight ID must be configured to 'Set By Pilot' in Configuration Mode for the **Flight ID** option to appear on the Transponder Page. Refer to the G3X Touch Installation Manual for more information.

Entering a Flight ID:

- 1) Touch the transponder data box on the CNS Bar.
- Or:**
- From the Main Menu, touch **XPDR**.
- 2) Enter the Flight ID using the keypad and touch **Enter**.



Flight ID (Transponder Data Box)

ADDITIONAL TRANSPONDER MESSAGES

Annunciation	Description	Action
XPDR FAULT	Generic message for faults received from the transponder.	Contact Garmin if the message persists.
XPDR CONFIG ERROR	The transponder is configured incorrectly. Consult the installation manual or Garmin dealer (as appropriate).	Consult the installation manual to verify configuration.

SECTION 5 GPS NAVIGATION

5.1 INTRODUCTION

The Map Page displays aviation data (e.g., airports, VORs, airways, airspaces), geographic data (e.g., cities, lakes, highways, borders), and topographic data (map shading indicating elevation) to be used for situational awareness only.

An aircraft icon is placed on the Navigation Map at the location corresponding to the calculated present position. The aircraft's current location is depicted as the center of the aircraft icon. The aircraft position and the flight plan legs are accurately based on GPS calculations. The basemap upon which these are placed is from a source with less resolution, therefore the relative position of the aircraft to map features is not exact. The leg of the active flight plan currently being flown is shown as a magenta line on the navigation map. The other legs are shown in white.

The Direct-to Window and the Nearest Pages can be displayed by pressing the corresponding buttons.

COMPASS ARC



NOTE: The compass arc is not available in 'North Up' map orientation.

A compass arc representing the aircraft's ground track, appears by default on the Map Page. The route line represents the course.

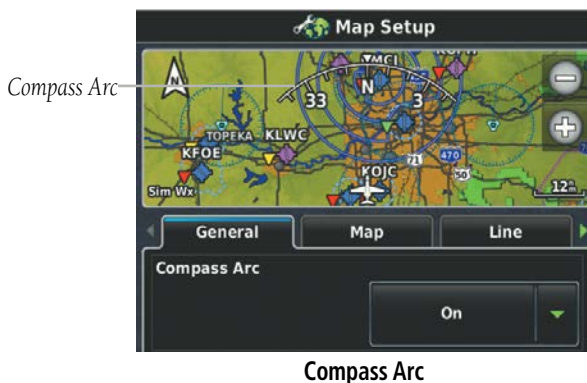

Enabling/disabling the Compass Arc:

- 1) With the Map Page displayed, press the **MENU** Key.
- 2) Touch **Set Up Map**.
- 3) Under the 'General' Tab, touch and drag to scroll down to the **Compass Arc** field.
- 4) Touch .
- 5) Touch **On** or **Off**.

When using the compass arc on the map display, the heading reference will be shown as a dashed line for several seconds. If a cross wind is present, the ownship symbol will rotate slightly to show the difference between the aircraft's heading (if available) and ground track.

5.2 USING MAP DISPLAYS



WARNING: *The G3X Touch™ map displays are to be used for situational awareness only.*

Map displays are used extensively in the G3X Touch to provide situational awareness in flight. Most G3X Touch maps can display the following information:

- Airports, NAVAIDs, airspaces, airways, land data (highways, cities, lakes, rivers, borders, etc.) with names
- Map Pointer information (distance and bearing to pointer, location of pointer, name, and other pertinent information)
- Map range
- Aircraft icon (representing present position)
- Flight plan legs
- User waypoints
- Track vector
- Topography data

The information in this section applies to the following maps unless otherwise noted:

- All Map Pages (MAP)
- Waypoint Page (WPT)
- All Nearest Pages (NRST)
- Active Flight Plan Page
- Direct-to Window

MAP PAGE SETUP

MAP ORIENTATION

Maps are shown in one of three different orientation options, allowing flexibility in determining aircraft position relative to other items on the map (North Up) or for determining where map items are relative to where the aircraft is going (Track Up), or desired track up (DTK Up).

- North Up aligns the top of the map display to north (default setting).
- Track Up aligns the top of the map display to the current ground track.
- Desired Track (DTK) Up aligns the top of the map display to the desired course.



NOTE: Map orientation can only be changed on the Map Page. Any other pages that show navigation data reflect the orientation selected for the Map Page.

Changing the Navigation Map orientation:

- 1) With the Map Page displayed, press the **MENU** Key.
- 2) Touch **Set Up Map**.
- 3) Under the 'General' Tab, touch and drag to scroll to the **Orientation** field.
- 4) Touch .
- 5) Touch **North Up**, **Track Up**, or **DTK Up**.

The pilot can also temporarily toggle orientation by touching the North Up arrow. The North Up toggle button behavior is dependant on the selected Map Orientation:

Map Orientation	Toggle Action
North Up	Track Up
Track Up	North Up
DTK Up	North Up

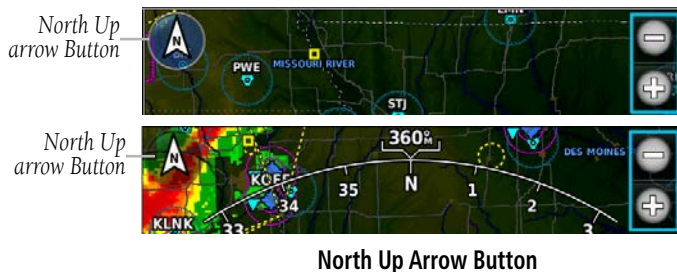

Setting the range above which to display North Up orientation:

- 1) With the Map Page displayed, press the **MENU** Key.
- 2) Touch **Set Up Map**.
- 3) Under the 'General' Tab, touch and drag to scroll to the **North Up Above** field.
- 4) Touch .
- 5) Touch the desired range.

Enabling/disabling North Up orientation on the ground:

- 1) With the Map Page displayed, press the **MENU** Key.
- 2) Touch **Set Up Map**.
- 3) Under the 'General' Tab, touch and drag to scroll to the **North Up On Ground** field.
- 4) Touch .
- 5) Touch **On** or **Off**.

DISPLAY FLIGHT PLAN INFORMATION ON MAP/CHARTS PAGE

With the flight plan information displayed on the Map/Charts Page (see procedure below), touch the flight plan to quickly access the Active Flight Plan Page.

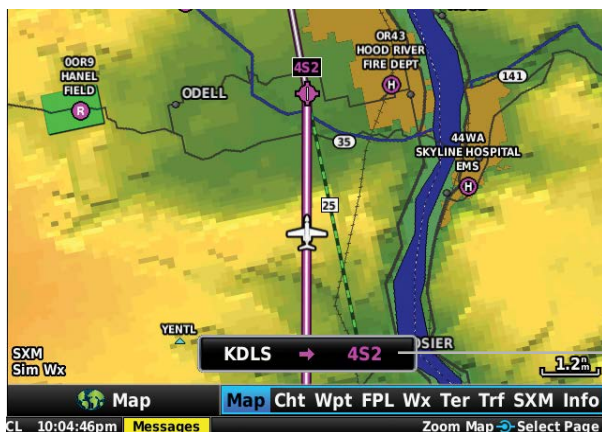

Touch to display the Flight Plan Page

Flight Plan Displayed on Map Page

Displaying/removing flight plan information on the map/charts page:

- 1) With the Map Page displayed, press the **MENU** Key.
- 2) Touch **Set Up Map**.
- 3) Under the 'General' Tab, touch and drag to scroll to the **Flight Plan Info** field.
- 4) Touch .
- 5) Touch **On** or **Off**.

AIRPORTS & NAVAIDS

Airport and NAVAID information can be customized to display a variety of information including: runway extension lines, runway numbers and visual reporting points (VRP). Runway extension lines show runway orientation relative to other landmarks and terrain features and are intended to aid in planning traffic pattern entry and/or departure routing.



Runway Extensions and Numbers (Map Page)

Setting up and customizing airports and NAVAIDs for the map page:

- 1) With the Map Page displayed, press the **MENU** Key.
- 2) Touch **Set Up Map**.
- 3) Touch and drag the tabs left or right to find the desired tab.
- 4) Touch the 'Airport' or 'Navaid' Tab.
- 5) Touch the  to display a list of options.
- 6) Touch the desired settings for each feature (on, off, auto, range, text size, etc.).

MAP TYPE

From the Map Setup Page the pilot can display either VFR or IFR maps. Refer to Section 5.4 for information on displaying/removing IFR airways.

Changing the Map Type (VFR/IFR):

- 1) With the Map Page displayed, press the **MENU** Key.
- 2) Touch **Set Up Map**.
- 3) Touch the 'Map' Tab.
- 4) Touch .
- 5) Touch **VFR** or **IFR**.

AIRSPACE

Setting up and customizing airspace for the map page:

- 1) With the Map Page displayed, press the **MENU** Key.
- 2) Touch **Set Up Map**.
- 3) Touch and drag the tabs left or right to find the desired tab.
- 4) Touch the 'Airspace' Tab.
- 5) Touch the  to display a list of options.
- 6) Touch the desired option for each airspace (on, off, auto, range, all (Atlantic), or below (Atlantic)).

MAP RANGE



NOTE: Refer to the *Additional Features* section for information on changing the FliteCharts® or ChartView range.

There are 23 different map ranges available (distances are dependant on configuration). The current range is indicated in the lower right corner of the map. The scale bar represents the map scale. To change the map range on any map, use the knob or touch the '+' (decrease visible range) or the '-' (increase visible range).



Map Range

Scale Bar Representing a Map Scale of 20 nm Per Scale Width.

AUTO ZOOM

Auto Zoom allows the G3X Touch to change the map display range to the smallest range clearly showing the active waypoint. Auto Zoom can be overridden by adjusting the range and remains that way until the active waypoint changes, a terrain or traffic alert occurs, or the aircraft takes off.

Safe Taxi also affects Auto Zoom. When the aircraft has landed at the destination airport, the navigation map automatically zooms in to display the Safe Taxi diagram.

Enabling/disabling Auto Zoom:

- 1) With the Map Page displayed, press the **MENU** Key.
- 2) Touch **Set Up Map**.
- 3) Under the 'General' Tab, find the **Autozoom** field.
- 4) Touch .
- 5) Touch **On** or **Off**.

MAP PANNING

Map panning allows the pilot to:

- View parts of the map outside the displayed range without adjusting the map range
- Highlight and select locations on the map

- Review information for a selected airport, NAVAID or user waypoint
- Designate locations for use in flight planning
- View airspace and airway information

To pan the map, touch and drag the map. Touch a map feature to get additional information. The map feature button shows not only the feature name (such as airport designation or waypoint name) but also shows the type (airport, waypoint, etc.). If multiple features are present at the map feature position, a green arrow will appear on the map feature button. Touch or to cycle through the list of map features present at that position.

The screenshot shows the GPS navigation interface with a map of the Wichita, Kansas area. A purple line indicates a flight path from the aircraft's current position (marked with a white airplane icon) to the selected map feature, KLWC. A white information box is overlaid on the map, displaying the following text: **KLWC 142152Z AUTO**, **16015G21KT 8SM FEW065**, and **34/17 A2987**. The map also shows various airports, airways, and terrain. The bottom of the screen displays a data panel with the following information: **Weather Info** (KLWC METAR), **293^{ft}**, **21.7^{kn}**, **N 39°00.667'**, **W 095°12.988'**, and **853^{ft} MSL**. The data panel also includes buttons for **Map**, **Map Cht Wpt FPL Wx Ter Trf Info Eng**, and **Zoom Map** and **Select Page**.

Information Box

Center on Aircraft's Current Location

Bearing and Distance to Selected Map Feature from the Aircraft's Present Position

Latitude/Longitude Position of Selected Map Feature

Elevation of the Selected Map Feature

Press button to create a User Waypoint at this location

Time to selected waypoint at the aircraft's current speed

Green Arrow Indicating Multiple Features are Present at the Location.

Map Feature (Type and Name)

Map Panning (Map Page)

Panning the map:

- 1) From any map, touch and drag.
- 2) Touch to re-center the map on the aircraft's current position.

Or:

Touch the **Back** button.

Reviewing information for a map feature:

- 1) From any map, touch a map feature.
- 2) If multiple map features are present, touch  to cycle through the list.
- 3) Touch the Map Feature button to display additional information.

FUEL RANGE RING



WARNING: The G3X Touch Fuel Calculator and/or Fuel Range Rings are NOT intended to be relied upon as the primary fuel indicator(s), and does not relieve the pilot from the responsibility of proper flight planning. G3X Touch fuel calculations do not use the aircraft fuel quantity indicators and are calculated from the last time the fuel was reset.

The Navigation Map can display fuel range rings which show the remaining flight distance. If current fuel endurance is greater than reserve, range-to-empty is shown as a solid green circle and range-to-reserve is a dashed green circle. If current endurance is less than reserve, range-to-empty is shown as a solid yellow circle. Fuel range rings are offset to show the effects of the wind at the current location (e.g., does not account for wind variations throughout the range).

Displaying/removing the fuel range rings and selecting a fuel reserve time:

- 1) With the Map Page displayed, press the **MENU** Key.
- 2) Touch **Set Up Map**.
- 3) Touch and drag the tabs left or right to find the desired tab.
- 4) Touch the 'Map' Tab.
- 5) Touch the  in the **Fuel Range (RSV)** field, and touch **On** or **Off**.
- 6) Touch '+' or '-' to adjust the fuel range reserve time (HH:MM).

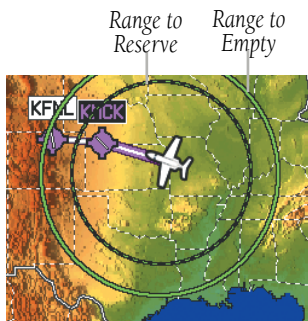

Navigation Map

GLIDE RANGE RING

The Glide Range Ring is displayed on the G3X Touch moving map when the pilot configures it 'ON' in the G3X Touch Map Settings. Under normal conditions the Glide Range Ring is displayed in cyan and is based on the configured glide ratio, terrain, obstacles, and winds. Upon Smart Glide activation, the G3X Touch begins to measure the actual real-time glide ratio and updates the range ring accordingly. This is indicated by a change in the range ring color from cyan to yellow. If any aircraft configuration changes are made (e.g., flaps, gear), it may take up to 30 seconds for the G3X Touch to determine the new glide ratio. Refer to the GTN Xi Pilot's Guide for more information about the Glide Range Ring operation with Smart Glide.

BEST AIRPORT BEARING POINTER



NOTE: In order to display the Best Airport Bearing Pointer, Best Glide Speed and Sink Rate (at VG) must be configured on the Aircraft Configuration Page in Configuration Mode. Refer to the G3X Touch Installation Manual for more information.

The Best Airport Bearing Pointer points to the airport within the Glide Range Ring that is considered the best option for a landing based on the following criteria:

- 1) The airport must be within glide range as determined by the following:
 - a) User entered glide performance (Sink Rate and Best Glide Speed).
 - b) Aircraft altitude and direction of flight.
 - c) Airport elevation.
 - d) Wind velocity.

- 2) The expected flyover altitude (i.e., airports with 1000' or greater margin take precedence).
- 3) Hard surface runways (i.e., paved runways take precedence over grass runways).
- 4) Runway lengths.
- 5) Runway alignment with the wind (if known).

Enabling/disabling the Best Airport Bearing Pointer:

- 1) With the full screen PFD displayed, press the **MENU** Key.
- 2) Touch  next to a bearing pointer to display the bearing pointer options.
- 3) Touch **Best Airport**.

Touch to Display the Best Airport Bearing Pointer



PFD Options



Bearing 1 Information Window
-Identifier
-Distance

Bearing 2 Information Window
-Identifier
-Distance

HSI with Bearing Pointers

BEST AIRPORT LINE

The Best Airport Line points to the same airport as the Best Airport Bearing Pointer but is available on the MFD and Split Screen Map displays instead of the HSI. The line appears as a series of cyan chevrons between the aircraft marker and the recommended glide-to airport.

Displaying/removing the Best Airport Line:

- 1) With the Map Page displayed, press the **MENU** Key.
- 2) Touch **Set Up Map**.
- 3) Touch and drag the tabs left or right to find the desired tab.
- 4) Touch the 'Line' Tab.
- 5) In the **Best Airport Line** field, touch **On** or **Off**.



Navigation Map



Navigation Map

SELECTED ALTITUDE INTERCEPT ARC

The map can display the location along the current track where the aircraft will intercept the selected altitude. The location will be shown as a cyan arc when the aircraft is climbing or descending.

Displaying/removing the selected altitude intercept arc:

- 1) With the Map Page displayed, press the **MENU** Key.
- 2) Touch **Set Up Map**.
- 3) Touch and drag the tabs left or right to find the desired tab.
- 4) Touch the 'Map' Tab.
- 5) In the **Selected Altitude Intercept Arc** field, touch **On** or **Off**.

MEASURING BEARING AND DISTANCE

The 'Measure Distance' option on Map Page menu is useful for measuring the distance between two points on the map. The distance tool displays a dashed Measurement Line and a Map Pointer to aid in graphically identifying points to measure. Lat/Long, bearing, distance, and elevation data is provided.

Measuring bearing and distance between any two points:

- 1) From the Map Page, press the **MENU** Key.
- 2) Touch **Measure Distance**.
- 3) Touch any point on the viewable navigation map to select the first reference point.
- 4) Touch **Set Ref** to select the second reference point to receive distance and bearing information from the first reference point to the second reference point.

System Overview

Flight Instruments

EIS

CNS Interface

GPS Navigation

Flight Planning

Hazard Avoidance

Additional Features

AFCs

Annun/Alerts

Appendix

Index



Reference Point
Measurement Line

Map Page (Measure Distance)

TOPOGRAPHY

Topographic data can be displayed or removed as described in the following procedures.

Displaying/removing topographic data:

- 1) From the Map Page, press the **MENU** Key.
- 2) Touch **Topo Shading**.



Topographic Shading (Map Page)

MAP PAGE TRAFFIC

Enabling/disabling traffic on the Map Page:

- 1) From the Map Page, press the **MENU** Key.
- 2) Touch **Traffic**.

Enabling/disabling TargetTrend Overlay:

- 1) From the Map Page, press the **MENU** Key.
- 2) Touch **Set Up Map**.

- 3) Under the 'Traffic' Tab, touch and drag to scroll to the **TargetTrend** field.
- 4) Touch .
- 5) Touch **On** or **Off**.

MAP SYMBOLS

Refer to Appendix G for a list of map symbols.

MAP DECLUTTER

The pilot can remove (declutter) unwanted items, such as highways from the map.

Decluttering the Map Page:

- 1) From the Map Page, press the **MENU** Key.
- 2) Touch **-1**, **-2**, or **-3** under **Map Detail**.

MAP DETAIL

The map detail can also be adjusted. Map detail changes the amount of detail with respect to the zoom scale.

- 1) From the Map Page, press the **MENU** Key.
- 2) Touch **Set Up Map**.
- 3) Touch and drag the tabs left or right to find the desired tab.
- 4) Touch the 'General' Tab.
- 5) Touch the  in the **Detail Level** field.
- 6) Touch **Least**, **Less**, **Normal**, **More**, or **Most**.

FEATURES DISPLAYED AT EACH MAP DETAIL LEVEL

Feature	0	1	2	3	Feature	0	1	2	3
River/Lake Names	•				Warning Areas	•	•		
Land/Country Text	•				Large Airports	•	•	•	
Large City	•				Medium Airports	•	•	•	
Medium City	•				Restricted Areas	•	•		

Features Displayed at Each Map Detail Level

	Feature	0	1	2	3	Feature	0	1	2	3
System Overview	Small City	•				Prohibited Areas	•	•	•	•
Flight Instruments	Small Town	•				MOAs	•	•		
EIS	Freeways	•				Runway Labels	•	•	•	
CNS Interface	Highways	•				Lightning Strike Data	•	•	•	
GPS Navigation	Roads	•				NEXRAD Data	•	•	•	•
Flight Planning	Railroads	•				Traffic Symbols	•	•	•	•
Hazard Avoidance	Political Boundaries	•	•	•	•	Traffic Labels	•	•	•	•
Additional Features	User Waypoints	•	•			Lakes/Major Rivers	•	•	•	•
AFCS	VORs	•	•	•		Minor Rivers	•			
Annun/Alerts	NDBs	•	•	•		Active FPL Legs	•	•	•	•
Appendix	Intersections	•	•	•		Airways	•	•	•	
Index	Class B Airspace	•	•			Proximity Circles	•	•	•	
	Class C Airspace	•	•			Storm Cells	•	•		
	Class D Airspace	•	•			Fronts	•	•	•	
	Tower	•	•	•	•	AIRMET	•	•		
	TRSA	•	•			SIGMET	•	•		
	ADIZ	•	•			AIRMET	•	•		
	Alert Areas	•	•			SIGMET	•	•		
	Caution Areas	•	•			TFR	•	•	•	•
	Danger Areas	•	•							

Features Displayed at Each Map Detail Level

5.3 AIRWAYS

Low Altitude Airways (or Victor Airways) primarily serve smaller piston-engine, propeller-driven airplanes on shorter routes and at lower altitudes. Airways are eight nautical miles wide and start 1,200 feet above ground level (AGL) and extend up to but not including 18,000 feet mean sea level (MSL). Low Altitude Airways are designated with a "V" before the airway number (hence the name "Victor Airways") since they run primarily between VORs.

High Altitude Airways (or Jet Routes) primarily serve airliners, jets, turboprops, and turbocharged piston aircraft operating above 18,000 feet MSL. Jet Routes start at 18,000 feet MSL and extend upward to 45,000 feet MSL (altitudes above 18,000 feet are called "flight levels" and are described as FL450 for 45,000 feet MSL). Jet Routes are designated with a "J" before the route number.

Low Altitude Airways are drawn in gray. High Altitude Airways are drawn in green. When both types of airways are displayed, high altitude airways are drawn on top of Low Altitude Airways.

When airways are selected for display on the map, the airway waypoints (VORs, NDBs, and Intersections) are also displayed.

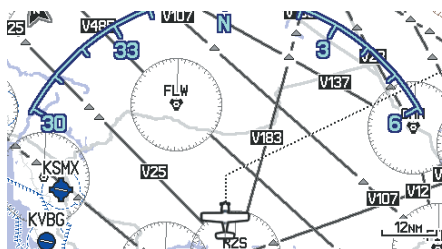

IFR Map



Airways may be displayed on the map at the pilot's discretion.

Displaying/removing airways:

- 1) Press the **MENU** Key twice.
- 2) Touch **Setup**.
- 3) Touch **Map**.
- 4) Touch and drag the tabs left or right to find the desired tab or turn the large Knob associated with the MFD.
- 5) Touch the 'Navaid' Tab.
- 6) Touch the  in the **Airways** field.
- 7) Touch **Off**, **Low**, **High**, or **Both**.

Reviewing information for an airway:

- 1) With the IFR map displayed on the Map Page (see procedure above), touch a map feature.

- 2) If multiple map features are present, touch  or  to cycle through the list.
- 3) With the airway selected, touch the Map Feature button to display additional information.



Low Altitude Airway Review Page

5.4 WAYPOINTS

The Waypoint (Wpt) Page provides airport and waypoint information.

Waypoints are predetermined geographical positions (internal database) or pilot-entered positions, and are used for all phases of flight planning and navigation.

Waypoints can be changed by entering the ICAO identifier, entering the name of the facility, or by entering the city name. As a waypoint identifier, facility name, or location is entered, the G3X Touch's Spell'N'Find™ feature scrolls through the database, displaying those waypoints matching the characters which have been entered up to that point. A direct-to navigation leg to the selected waypoint can be initiated by pressing the Direct-to Key from the Waypoint Page.

The following descriptions and abbreviations are used:

- Usage type: Public, Military, or Private
- Runway surface type: Hard, Turf, Sealed, Gravel, Dirt, Soft, Unknown, or Water

- Runway lighting type: No Lights, Part Time, Full Time, Unknown, or PCL Freq (for pilot-controlled lighting)
- COM Availability: TX (transmit only), RX (receive only), PT (part time), * (additional information available)

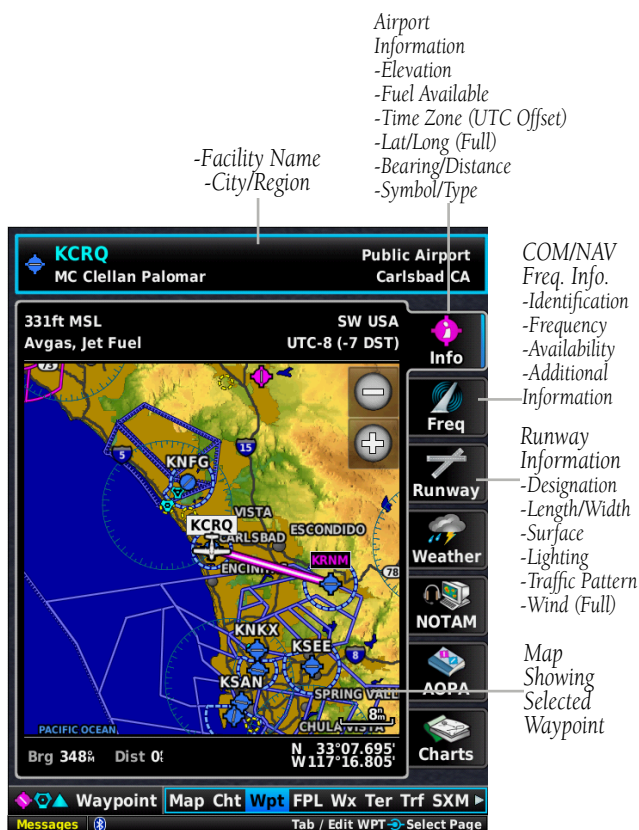

Waypoint Page - Info Tab

Selecting an airport for review by identifier, facility name, or location:

- 1) From the Waypoint (Wpt) Page, touch the waypoint identifier at the top of the page.
- 2) Enter the waypoint identifier using the keypad and touch **Enter**.

Or:

Touch **Find > Search Name > Search by Facility Name**. Enter the facility name using the keypad and touch **Enter**.

Or:

Touch **Find > Search City > Search by City**. Enter the city name using the keypad and touch **Enter**.

If duplicate entries exist for an identifier, a Duplicates Found Window is displayed. Touch the desired options from the Duplicates Found Window.

Selecting a runway:

- 1) From the Waypoint (Wpt) Page, touch the **Runway** Tab if necessary.
- 2) Touch the waypoint identifier at the top of the page.
- 3) Enter the waypoint identifier using the keypad and touch **Enter**.
- 4) If necessary, touch the  to display additional runways. Touch the desired runway.

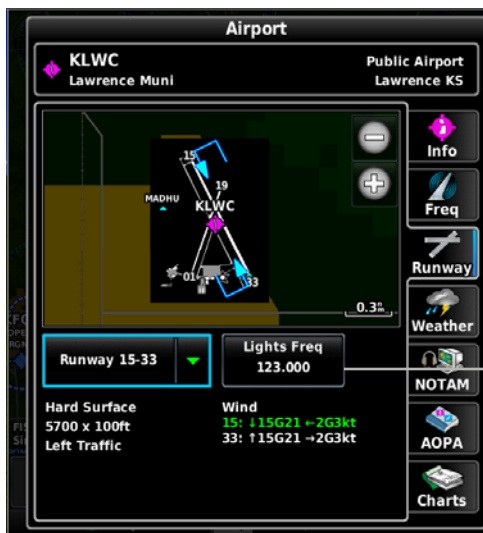

Runway Selection

Viewing additional information for a frequency:

The **Freq** Tab uses the descriptions and abbreviations listed in the following table:

- System Overview
- Flight Instruments
- EIS
- CNS Interface
- GPS Navigation
- Flight Planning
- Hazard Avoidance
- Additional Features
- AFCs
- Annun/Alerts
- Appendix
- Index

Communication Frequencies			Navigation Frequencies
Approach *	Control	Pre-Taxi	ILS
Arrival *	CTA *	Radar	LOC
ASOS	Departure *	Ramp	
ATIS	Gate	Terminal*	
AWOS	Ground	TMA *	
Center	Helicopter	Tower	
Class B *	Multicom	TRSA *	
Class C *	Other	Unicom	
Clearance			
* May include Additional Information			

Frequency Abbreviations

- 1) With the Waypoint (WPT) Page displayed, touch the **Freq** Tab.
- 2) Touch the desired frequency to tune.
- 3) Touch the **(i)** button to view additional information.

AUTOMATIC WAYPOINT SELECTION

Automatic waypoint selection is the system's attempt to deduce what Waypoint to display based on the aircraft's location in relation to the departure airport and/or the waypoints in the Flight Plan.

The pilot can override Automatic Waypoint Selection by manually entering a waypoint. The automatic selection will not resume until such time the manually entered waypoint and the automatically selected waypoint coincide.

NEAREST INFORMATION

The G3X Touch provides a **NRST** Key which gives the pilot quick access to nearest airport, weather, VOR, NDB, intersection, user waypoint, city, ARTCC, FSS, VRPs, and airspace information. If none are available, "None Within 200 NM" is displayed. "No Immediate Airspace" is displayed if airspace is not within 10 minutes based on current speed, track, and altitude.

Viewing nearest information:

- 1) Press the **NRST** Key.
- 2) Touch the Page Navigation Bar.
- 3) Touch **Airports, Airport Weather, VORs, NDBs, Intersections, User Waypoints, Cities, ARTCC, FSS, VRPs, or Airspace**.
- 4) Touch the desired option from the list.

NEAREST AIRPORT CRITERIA

From the Menu on the Nearest Airports Page the pilot can define the minimum runway length and surface type used when determining the 15 nearest airports to display on the Nearest Airports Page. A minimum runway length and/or surface type can be entered to prevent airports with small runways or runways that are not appropriately surfaced from being displayed. Default settings are 0 feet (or meters) for runway length and "Any" for runway surface type. Private airports and Heliports can also be included.

The Page Menu also allows the pilot to choose between displaying the facility names and city names.

- **Runway Surface:** Allows the pilot to set criteria for the type of surface on the runway.
 - Any: Shows any runway, regardless of surface type, including water landing facilities.
 - Hard only: Shows only runways with a concrete, asphalt, or similar sealed surface.
 - Hard or Soft: Shows all runways except water landing facilities.
 - Water only: Shows only water landing facilities.
- **Minimum Runway Length:** Allows the pilot to enter a specific length for the shortest runway allowed.
- **Include Private Airports:** Allows the pilot to include Private Airports in the search criteria.

Entering airport/heliport criteria:

- 1) Press the **NRST** Key.
- 2) Press the **MENU** Key.
- 3) Touch the Runway Surface field and touch **Hard only**, **Hard/Soft**, **Water only**, or **Any**.

Or:

Touch the Min Runway Length value and enter the value using the keypad.

Or:

Touch **Private Airports**.

Or:

Touch **Heliports**.

Or:

Touch **City Names**: Displays city names below the airport identifier on the Nearest APT Page.

Or:

Touch **Facility Names**: Displays facility names below the airport identifier on the Nearest APT Page.

WEATHER INFORMATION

Textual weather information can be viewed from the Waypoint Page.

Selecting airport weather information:

From the Waypoint Page, touch the **Weather** Tab.

Or:

From the Nearest Airport Weather Page, touch the desired airport and touch the **Weather** Tab.

INTERSECTIONS

Intersections can be viewed from the Waypoint Page or the Nearest Intersections Page. In addition to displaying a map of the currently selected intersection and surrounding area, the Intersection Information Page displays the region, bearing, distance, latitude, and longitude.

Selecting an intersection:

- 1) From the Waypoint (Wpt) Page.
- 2) Touch the waypoint identifier at the top of the page.
- 3) Enter the intersection using the keypad and touch **Enter**.

Or:

- 1) Press the **NRST** Key.
- 2) Touch the Page Navigation Bar.
- 3) Touch **Intersections**.
- 4) Touch the desired intersection from the list.

NDBs

NDBs can be viewed from the Waypoint Page or the Nearest NDBs Page. In addition to displaying a map of the currently selected NDB and surrounding area, the page displays the region, bearing, distance, latitude, longitude, frequency, identifier, name, city, state, NDB type, and More Code identification.

The Nearest NDB Page can be used to quickly find a NDB close to the flight path. The list only includes NDBs that are within 200nm. If there are no NDBs in the list, text indicating that there are no nearest NDBs is displayed. If there are no nearest NDBs in the list, the information and frequency fields are dashed.

Selecting a NDB:

- 1) From the Waypoint (Wpt) Page.
- 2) Touch the waypoint identifier at the top of the page.
- 3) Enter the NDB identifier using the keypad and touch **Enter**.

Or:

- 1) Press the **NRST** Key.
- 2) Touch the Page Navigation Bar.
- 3) Touch **NDBs**.
- 4) Touch the desired NDB from the list.

VORs

VORs can be viewed from the Waypoint Page or the Nearest VORs Page. In addition to displaying a map of the currently selected VOR and surrounding area, the page displays the region, city, state, bearing, distance, latitude, longitude, frequency, class (High, Low, or Terminal VOR), facility name, and aircraft's current radial from the VOR.

The Nearest VOR Page can be used to quickly find a VOR close to the flight path. The list only includes VORs that are within 200nm. If there are no VORs in the list, "None Within 200nm" is displayed.

Selecting a VOR:

- 1) From the Waypoint (Wpt) Page.
- 2) Touch the waypoint identifier at the top of the page.
- 3) Enter the VOR identifier using the keypad and touch **Enter**.

Or:

- 1) Press the **NRST** Key.
- 2) Touch the Page Navigation Bar.
- 3) Touch **VORs**.
- 4) Touch the desired VOR from the list.

USER WAYPOINTS

The G3X Touch can create and store up to 3,000 user-defined waypoints. Once a waypoint has been created, it can be renamed, deleted, or moved.



NOTE: *Most terrain and obstacle warnings will be suppressed when the aircraft is determined to be taking off or landing at an airport - including an airport that's defined by a user waypoint (that has been saved as an airport symbol) instead of the navigation database.*

Creating user waypoints:

- 1) Touch anywhere on the map.

Or:

- 1) Touch aircraft symbol on the map.
- 2) Touch the **Latitude/Longitude Location** Button.

- 3) Optionally, touch the **Name** field to enter the new waypoint name and touch **Enter**.
- 4) Touch the default symbol.
- 5) Touch the desired symbol.
- 6) If desired touch the **Altitude** value.
- 7) Enter the desired altitude and touch **Enter**.
- 8) If desired touch the Location value.
- 9) Touch the arrows to change the location and touch **Enter**.

Marking Current Location as a Waypoint:

- 1) From the **Info** Page, touch the latitude and longitude.

Or:

- 1) From the **Info** Page, press the **MENU** Key, and touch **Mark Waypoint**.
- 2) Touch **Yes** on the confirmation dialog box.
- 3) Optionally touch the **Name** field to rename the waypoint.
- 4) Touch **Back**.

Creating a proximity waypoint:

- 1) Press the **MENU** Key twice.
- 2) Touch **User Waypoints**.
- 3) Touch the **Proximity** Tab.
- 4) Press the **Menu** Key.
- 5) Touch **New Proximity Waypoint**.

- a) Touch **Use Identifier**.
- b) Enter the desired identifier using the keypad.

Or:

- a) Touch **Use Map**.
- b) Touch anywhere on the map. If the location does not correspond to a waypoint, a user waypoint will be created at that location.

- 6) Touch **Enter**.

Selecting and viewing nearest user waypoints:

- 1) Press the **NRST** Key.

- 2) Touch **User Waypoints**.
- 3) Touch the desired user waypoint.

Editing or renaming a user waypoint:

- 1) Press the **NRST** Key.
- 2) Touch **User Waypoints**.
- 3) Touch the desired user waypoint.
- 4) Press the **MENU** Key.
- 5) Touch **Edit Waypoint**.
- 6) Touch the desired field to edit.
- 7) Make the necessary changes and touch **Back**.

Deleting user waypoints:

- 1) Press the **NRST** Key.
- 2) Touch **User WPTs**.
- 3) Touch the desired user waypoint.
- 4) Press the **MENU** Key.
- 5) Touch **Delete Waypoint**.
- 6) Touch **Yes**.

IMPORTING/EXPORTING USER WAYPOINTS

G3X Touch supports importing/exporting user waypoints to/from a GPX file on the SD Card via the User Waypoints Page. However FPL files may also contain user waypoints. Through the process of importing these files via the Flight Plan List Page, any user waypoints in the imported flight plan are saved to the internal database and are displayed on the User Waypoints Page.

Importing user waypoints:

- 1) Press the **MENU** Key twice.
- 2) Touch **User Waypoints**.
- 3) Press the **Menu** Key.
- 4) Touch **Import**.
- 5) Touch **Yes**.

Exporting user waypoints:

- 1) Press the **MENU** Key twice.
- 2) Touch **User Waypoints**.
- 3) Press the **Menu** Key.
- 4) Touch **Export**.
- 5) Touch **Yes**.

5.5 AIRSPACE

The Nearest Airspace Page and Airspace Alerts provide information about airspaces and the location of the aircraft in relationship to them. The Nearest Airspace Page can be used to quickly find airspaces close to the flight path.

The Nearest Airspace Page displays the class of airspace, controlling agency, vertical boundaries, and status.

Selecting and viewing nearest airspaces:

- 1) Press the **NRST** Key.
- 2) Touch the Page Navigation Bar.
- 3) Touch **Airspace**.
- 4) Touch the desired airspace.

AIRSPACE ALERT MESSAGES

When an airspace alert appears, press the **NRST** Key to automatically show nearby airspace information on the Nearest Airspace Page. This information includes name, time to entry (if applicable), and status.

There are four types of status information:

- Ahead—Projected to enter the airspace within the next 10 minutes or less
- Near—Within two nautical miles of an airspace but not projected to enter it
- Near & Ahead—Projected to enter the airspace within two nautical miles
- Inside Airspace—Within the boundaries of the airspace

SMART AIRSPACE™ AND ALTITUDE OVERLAYS

Smart Airspace™ integration makes it easier for pilots to identify what airspace lies ahead. This feature conveniently highlights the airspace nearest to the aircraft's current altitude and de-emphasizes non-pertinent airspace so pilots can quickly distinguish their location to the relevant airspace around them.

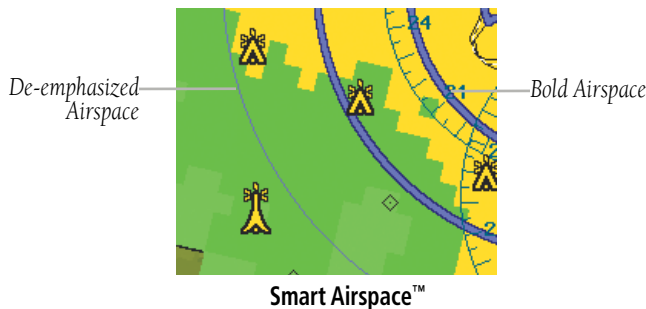

Enabling/disabling Smart Airspace:



NOTE: Smart Airspace selection is not available if the Map Type is set to IFR instead of VFR since IFR flights do not have the same operational concerns with airspace.

- 1) Press the **MENU** Key twice.
- 2) Touch **Setup**.
- 3) Touch **Map**.
- 4) Touch and drag the tabs left or right to find the desired tab.
- 5) Touch the 'Airspace' Tab.
- 6) Touch and drag to display the 'Smart Airspace' field.
- 7) Touch the  to display a list of options.
- 8) Touch **On** or **Off**.

Additionally, airspace altitude overlays can be depicted on the moving map and reduce pilot workload, particularly in congested airspace. With airspace altitude overlays, pilots can easily view airspace maximum and minimum altitudes, so it's easier to identify airspace altitude limitations at a glance.



Smart Airspace™ with Altitude Overlays

Enabling/disabling Altitude Overlays:

- 1) Press the **MENU** Key twice.
- 2) Touch **Setup**.
- 3) Touch **Map**.
- 4) Touch and drag the tabs left or right to find the desired tab.
- 5) Touch the 'Airspace' Tab.
- 6) Touch and drag to display the 'Altitude Labels' field.
- 7) Touch the  to display a list of options.
- 8) Touch **Off**, **Auto**, **2nm**, **3nm**, **5nm**, **8nm**, **12nm**, **20nm**, **30nm**, **50nm**, **80nm**, or **120nm**.

5.6 DIRECT-TO NAVIGATION USING THE G3X TOUCH

The Direct-to method of navigation, initiated by pressing the **Direct-to** Key is quicker to use than a flight plan when the desire is to navigate to a single point such as a nearby airport.

Once a direct-to is activated, the G3X Touch establishes a point-to-point course line from the present position to the selected direct-to destination. Course guidance is provided until the direct-to is replaced with a new direct-to or flight plan, or canceled.

Entering a waypoint identifier, facility name, or city as a direct-to destination:

- 1) Press the **Direct-to** Key. The Direct-to Window is displayed (with the active flight plan waypoint as the default selection or a blank waypoint field if no flight plan is active).
- 2) If an external navigator is configured, touch **FPL Source** > **Internal** from the FPL Page.
- 3) Touch the waypoint identifier.
- 4) Enter the waypoint identifier using the keypad and touch **Enter**.

Or:

Touch **Find** > **Search Name** > **Search by Facility Name**. Enter the facility name using the keypad and touch **Enter**.

Or:

Touch **Find** > **Search City** > **Search by City**. Enter the city name using the keypad and touch **Enter**.

- 5) Touch **Activate**.

Entering latitude and longitude coordinates as a direct-to destination:

- 1) Press the **Direct-to** Key. The Direct-to Window is displayed
- 2) Press the **MENU** Key.
- 3) Touch **Enter Coordinates**.
- 4) Specify coordinates, and touch **Enter**.
- 5) Touch **Activate**.

Selecting Recent Waypoints, Nearest Airports, Flight Plan Waypoints, or User Waypoints as a direct-to destination:

- 1) Press the **Direct-to** Key. The Direct-to Window is displayed (with the active flight plan waypoint as the default selection or a blank waypoint field if no flight plan is active).
- 2) If an external navigator is configured, touch **FPL Source** > **Internal** from the FPL Page.
- 3) Touch the waypoint identifier.
- 4) Touch **Find**

5) Touch the **Recent** Tab.

Or:

Touch the **Nearest Airports** Tab. When properly configured, the Best Glide Airport is displayed above the Nearest Airport List.

Or:

Touch the **Flight Plan** Tab.

Or:

Touch the **User** Tab.

6) Touch the desired waypoint.

7) Touch **Activate**.

Selecting a waypoint as a direct-to destination using the pointer:

1) Touch anywhere on the map.

2) Press the **Direct-to** Key.

3) If an external navigator is configured, touch **FPL Source** > **Internal** from the FPL Page.

4) Touch **Activate**.

Canceling or resuming a direct-to:

1) Press the **Direct-to** Key.

2) If an external navigator is configured, touch **FPL Source** > **Internal** from the FPL Page.

3) Touch **Stop Navigation** or **Resume Flight**.

SECTION 6 FLIGHT PLANNING

6.1 INTRODUCTION



CAUTION: Only the final course segment (usually from the final approach fix to the missed approach point) of the published approach is available if an external navigator is NOT configured.



NOTE: In order to add, delete, or change flight plan waypoints from the G3X Touch™ when an external GPS navigator is configured, touch **FPL Source** > **Internal** from the Active Flight Plan Page or Direct-to Page. Press the **FPL Source** > **External** to return to the external GPS navigator's flight plan.



NOTE: While navigating using an external GPS navigation source, the ability to edit/invert/delete the Active Flight Plan or activate a Saved Flight Plan is disabled.



NOTE: Refer to section 8.9 (Connex Cockpit Connectivity) for information on wirelessly transferring flight plans from a mobile device (using Garmin Pilot or Garmin Portables) to the G3X Touch or external navigator (if configured).

Flight planning on the G3X Touch consists of building a flight plan by entering waypoints one at a time and inserting approaches as needed. The flight plan is displayed on maps using different line widths, colors, and types, based on the type of leg and the segment of the flight plan currently being flown.

Up to 50 flight plans with up to 300 waypoints each can be created and stored in memory. One flight plan can be activated at a time and becomes the active flight plan. The active flight plan is erased when the destination is reached and the system is turned off. When storing flight plans with an approach, the G3X Touch uses the waypoint information from the current database to define the waypoints. If the database is changed or updated, the G3X Touch automatically updates the information. If an approach is no longer available, the procedure is deleted from the affected stored flight plan(s), and an alert is displayed.

Whenever an approach is loaded into the active flight plan it replaces the destination airport with a sequence of waypoints for the selected approach. The airport must have a published instrument approach and only the final course segment (usually from final approach fix to missed approach point) of the published approach is available if an external navigator is not configured.

FLIGHT PLAN DATA FIELDS

Changing the information shown in the flight plan data fields:

- 1) With a flight plan displayed, touch **FPL Source** > **Internal** if an external navigator is configured (Active Flight Plan only).
- 2) Touch one of the data fields to change.
- 3) Touch the desired data field.

MANUALLY SWITCHING BETWEEN INTERNAL AND EXTERNAL FLIGHT PLAN SOURCES



NOTE: The selection of the GPS navigation source to persist through power cycles or reset to the external GPS navigation source is dependent on the configuration. Refer to the G3X Touch Installation Manual for more information.



NOTE: On a standalone MFD, touch 'GPS' in the lower left corner of the touchscreen to switch between 'Internal' and 'External' navigation sources.

Touch **FPL Source** > **Internal** on the Active Flight Plan Page or the Direct-to Page, to temporarily allow flight planning through the G3X Touch using the internal GPS flight plan when an external GPS Navigator is configured. Press the **FPL Source** > **External** to return to the external GPS navigator's flight plan.

When manually selecting the internal GPS flight plan, 'INT' is displayed in cyan in the lower left quadrant of the HSI.

FAILURE OF THE EXTERNAL GPS NAVIGATION SOURCE

If the external GPS navigation source fails, the system reverts to the internal GPS navigation source and 'REV' is shown in yellow in the lower left quadrant of the HSI.

6.2 FLIGHT PLAN CREATION USING THE G3X TOUCH

The active flight plan is listed on the Active Flight Plan Page. It is the flight plan to which the G3X Touch is currently providing guidance, and is shown on the navigation maps. Stored flight plans are listed on the Flight Plan List Page, and are available for activation (becomes the active flight plan).



Active Flight Plan Page

Creating an active flight plan using the G3X Touch:

- 1) Touch the Page Navigation Bar.
- 2) Touch **Active FPL**.
- 3) If an external navigator is configured, touch **FPL Source** > **Internal**.
- 4) Touch **Add Waypoint**.

5) Enter the waypoint using the keypad.

Or:

Touch **Find** > **Recent** Tab.

Or:

Touch **Find** > **Nearest Airports** Tab.

Or:

Touch **Find** > **Flight Plan** Tab.

Or:

Touch **Find** > **User** Tab.

Or:

Touch **Find** > **Search Name** > **Search by Facility Name**. Enter the facility name using the keypad.

Or:

Touch **Find** > **Search City** > **Search by City**. Enter the city name using the keypad.

6) Touch **Enter**.

7) Repeat steps 4-6 for each additional waypoint.

Creating a stored flight plan using the G3X Touch:

1) Press the **MENU** Key twice.

2) Touch **Flight Plan List**.

3) Press **MENU**.

4) Touch **New Flight Plan**.

5) Touch **Add Waypoint**.

6) Enter the waypoint using the keypad.

Or:

Touch **Find** > **Recent** Tab.

Or:

Touch **Find** > **Nearest Airports** Tab.

Or:

Touch **Find** > **Flight Plan** Tab.

Or:

Touch **Find** > **User** Tab.

Or:

Touch **Find** > **Search Name** > **Search by Facility Name**. Enter the facility name using the keypad.

Or:

Touch **Find** > **Search City** > **Search by City**. Enter the city name using the keypad.

- 7) Touch **Enter**.
- 8) Repeat steps 4-6 for each additional waypoint.
- 9) The new flight plan is now in the list.

6.3 AUTOMATIC SHARING OF G3X TOUCH FLIGHT PLANS WITH EXTERNAL IFR NAVIGATORS

The G3X Touch system has the ability to share (crossfill) flight plans created/edited on the G3X Touch (using internal flight planning) with compatible external IFR navigators. The IFR navigator must be correctly configured and wired to perform this function. To access the internal flight plan on the G3X Touch, touch **FPL Source** > **Internal** from the Active Flight Plan Page.

Once configured/wired correctly, when an internal flight plan is created using the G3X Touch, that flight plan is automatically shared (crossfilled) to the external IFR navigator.

If the G3X Touch is using internal flight planning during a VFR flight, the IFR navigator stays synchronized with any changes in the G3X Touch flight plan (this is useful if there is a need to switch to the IFR navigator during flight).

SIDs, STARs, and approaches cannot be loaded/activated from the G3X Touch display. Alternatively, a multi-point flight plan may be created/edited by switching to the external navigator. Touch **FPL Source** > **External** from the Active Flight Plan Page, to switch to the external IFR navigator, which does allow loading/activating an approach if needed.

- System Overview
- Flight Instruments
- EIS
- CNS Interface
- GPS Navigation
- Flight Planning
- Hazard Avoidance
- Additional Features
- AFCs
- Annun/Alerts
- Appendix
- Index



NOTE: The G3X Touch system only crossfills multi-point flight plans with the external IFR navigator when using internal flight planning on the G3X Touch. Direct-To operations and single point flight plans are not crossfilled between the systems.



NOTE: Any Direct-To operation must be commanded on the external IFR navigator (G3X Touch or IFR navigator) being used.



NOTE: Switch the G3X Touch system to external flight planning to use the IFR navigator for normal flight planning (including enroute, SIDs, STARs, and approaches).

EXTERNAL IFR NAVIGATOR CROSSFILL CONFIGURATION (GPS 175, GNC® 355, GNX 375™, AND GTN™ 6XX/7XX (VERSION 6.62 AND NEWER ONLY))

Two configuration changes are required to enable the crossfill function:

In normal mode, **External FPL Crossfill** must be enabled on the System Setup page.



External Flight Plan Crossfill Enabled (Normal Mode)

In configuration mode, **External FPL** must be enabled on the Main System configuration page.



External Flight Plan Enabled (Configuration Mode)

Refer to the appropriate installation manual for instructions on entering configuration mode.

6.4 FLIGHT PLAN STORAGE USING THE G3X TOUCH

The G3X Touch can store up to 50 flight plans. The active flight plan is erased when another flight plan is activated. Details about each stored flight plan can be viewed on the Flight Plan List Page

Viewing information about a stored flight plan:

- 1) Press the **MENU** Key twice.
- 2) Touch **Flight Plan List**.
- 3) Touch the desired flight plan.
- 4) Touch **Edit**.

Storing an active flight plan from the Active Flight Plan Page:

- 1) From the Active Flight Plan, touch **FPL Source** > **Internal** if an external navigator is configured.
- 2) Press the **MENU** Key.
- 3) Touch **Save Copy**.

6.5 FLIGHT PLAN ACTIVATION USING THE G3X TOUCH

Activating a stored flight plan erases the active flight plan and replaces it with a copy of the flight plan being activated. A saved approach will be moved to 'loaded' when activating a flight plan.

Inverting a stored flight plan reverses the waypoint order. Touching 'Invert' on a saved flight plan will invert the flight plan in place without activating it. The original flight plan is overwritten by the inverted flight plan. A flight plan cannot be inverted if it has an associated approach.

Activating a stored flight plan:

- 1) Press the **MENU** Key twice.
- 2) Touch **Flight Plan List**.
- 3) Touch the desired flight plan.
- 4) Touch **Activate**.
- 5) Touch **Yes**.

Or:

- 1) When editing a saved flight plan, press the **MENU** Key.
- 2) Touch **Activate**.
- 3) Touch **Yes**.

Activating a Flight Plan Leg:

- 1) From the Active Flight Plan, touch **FPL Source** > **Internal** if an external navigator is configured.
- 2) Touch the waypoint leg to be activated.
- 3) Touch **Activate Leg**.
- 4) Touch **Yes**.

Canceling an On Route Direct-To or Active Leg:

- 1) Press the **MENU** Key.
- 2) Touch **Resume Flight Plan**.

Or:

- 1) Press the **Direct-To** Key.
- 2) Touch **Resume Flight Plan**.

6.6 FLIGHT PLAN EDITING

ADDING WAYPOINTS TO AN EXISTING FLIGHT PLAN

Waypoints can be added to the active internal flight plan or any stored flight plan. Choose the flight plan, select the desired point of insertion, enter the waypoint, and it is added before or after the selected waypoint. Flight plans are limited to 300 waypoints (including approach waypoints).

Adding a waypoint to a flight plan:

- 1) With a flight plan displayed, touch **FPL Source** > **Internal** if an external navigator is configured (Active Flight Plan only).
- 2) Touch the point in the flight plan to add the new waypoint.
- 3) Touch **Insert Before** or **Insert After**.
- 4) Enter the waypoint using the keypad.

Or:

Touch **Find** > **Recent** Tab.

Or:

Touch **Find** > **Nearest Airports** Tab.

Or:

Touch **Find** > **Flight Plan** Tab.

Or:

Touch **Find** > **User** Tab.

Or:

Touch **Find** > **Search Name** > **Search by Facility Name**. Enter the facility name using the keypad.

Or:

Touch **Find** > **Search City** > **Search by City**. Enter the city name using the keypad.

- 5) Touch **Enter**.

Adding a waypoint to a flight plan using the map:

- 1) With a flight plan displayed, touch **FPL Source** > **Internal** if an external navigator is configured (Active Flight Plan only).
- 2) Press **Menu**.
- 3) Touch **Edit on Map**.
- 4) Touch the desired leg on the map. Leg will transition from cyan to white to indicate that it is the selected leg.
- 5) With the flight plan leg selected, touch the waypoint to insert. If multiple waypoints are available at the selected location, they are displayed in boxes next to the selected location.
Note: If no waypoints exist at the location, the pilot will be prompted to create a User Waypoint.
Note: A leg can also be dragged and dropped onto the new location.
Note: Without selecting a desired leg, touching a waypoint (empty location, etc.) will add that waypoint to the end of the flight plan.
- 6) Touch **Save**.

Removing a waypoint from a flight plan:

- 1) With a flight plan displayed, touch **FPL Source** > **Internal** if an external navigator is configured (Active Flight Plan only).
- 2) Touch waypoint to remove.
- 3) Touch **Remove**.

EDITING FLIGHT PLAN SPEED, FUEL, AND/OR NAME



NOTE: If a fuel flow sensor is configured, the user-entered 'Plan Fuel' value is used while on the ground. In the air, the 'Plan Fuel' field is hidden and the fuel calculations are based on the actual measured fuel flow.

On the ground, regardless of fuel input, Plan Fuel and Plan Speed data fields are used to source information for data fields (such as 'Leg ETE' or 'Fuel Req'd') to help the pilot in flight planning. Without fuel input, the 'specified' fuel burn value and 'actual' speed are used for the Plan Fuel and Plan Speed data fields. With fuel input, the 'actual' fuel burn and speed are used to populate these data fields.

Adjusting the Active Flight Plan fuel:

- 1) From the Active Flight Plan, touch **FPL Source** > **Internal** if an external navigator is configured.
- 2) Touch **Plan Fuel**.
- 3) Enter the desired value using the keypad and touch **Enter**.



Adjusting the Saved Flight Plan speed and fuel:

- 1) Press the **MENU** Key twice.
- 2) Touch **Flight Plan List**.
- 3) Touch the desired saved flight plan.
- 4) Touch **Edit**.
- 5) Touch **Plan Fuel**.
- 6) Enter the desired value using the keypad and touch **Enter**.
- 7) Touch **Plan Spd**.
- 8) Enter the desired value using the keypad and touch **Enter**.

Editing the Saved Flight Plan Name:

- 1) Press the **MENU** Key twice.
- 2) Touch **Flight Plan List**
- 3) Touch the desired saved flight plan.

- 4) Touch **Edit**.
- 5) Press the **MENU** Key.
- 6) Touch the **Name** field.
- 7) Enter the desired name using the keypad and touch **Enter**.

Or:

Touch the name field at the top of the window.

Enter the desired name using the keypad and touch **Enter**.

COPYING FLIGHT PLANS

The G3X Touch allows copying a flight plan into a new flight plan memory slot, allowing editing, etc., without affecting the original flight plan. This can be used to duplicate an existing stored flight plan for use in creating a modified version of the original stored flight plan.

Copying a stored flight plan:

- 1) Press the **MENU** Key twice.
- 2) Touch **Flight Plan List**.
- 3) Touch the desired saved flight plan to copy.
- 4) Touch **Copy**.

DELETING FLIGHT PLANS

Individual or all stored flight plans can be deleted from the G3X Touch memory.

Deleting a stored flight plan:

- 1) Press the **MENU** Key twice.
- 2) Touch **Flight Plan List**.
- 3) Touch the desired saved flight plan to delete.
- 4) Touch **Delete**.
- 5) Touch **Yes**.

Deleting all stored flight plans:

- 1) Press the **MENU** Key twice.
- 2) Touch **Flight Plan List**.
- 3) Press the **MENU** Key.

- 4) Touch **Delete All**.
- 5) Touch **Yes**.



NOTE: The changes made to the active flight plan affect navigation as soon as they are entered. Editing the active flight plan does not affect any saved flight plans. Waypoints in the final approach segment (such as the FAF or MAP) can not be deleted individually.

Deleting the Active Flight Plan:

- 1) From the Active Flight Plan, touch **FPL Source** > **Internal** if an external navigator is configured.
- 2) Press the **MENU** Key.
- 3) Touch **Stop Navigation**.

Deleting an individual waypoint from the active flight plan:

- 1) From the Active Flight Plan, touch **FPL Source** > **Internal** if an external navigator is configured.
- 2) Touch the desired waypoint to delete.
- 3) Touch **Remove**.
- 4) Touch **Yes**.

Deleting an individual waypoint from a saved flight plan:

- 1) Press the **MENU** Key twice.
- 2) Touch **Flight Plan List**.
- 3) Touch the desired saved flight plan.
- 4) Touch **Edit**.
- 5) Touch the desired waypoint to delete.
- 6) Touch **Remove**.
- 7) Touch **Yes**.

INVERTING A FLIGHT PLAN

Any flight plan may be inverted (reversed) for navigation back to the original departure point.

Inverting the active flight plan:

- 1) From the Active Flight Plan, touch **FPL Source** > **Internal** if an external navigator is configured.
- 2) Press the **MENU** Key.
- 3) Touch **Invert**.
- 4) Touch **Yes**.

Inverting a saved flight plan:

- 1) Press the **MENU** Key twice.
- 2) Touch **Flight Plan List**.
- 3) Touch the desired saved flight plan.
- 4) Press the **Menu** Key.
- 5) Touch **Invert**.
- 6) Touch **Yes**.

IMPORTING/EXPORTING FLIGHT PLANS

Importing/exporting flight plans requires an SD card to be inserted in the unit.

Importing flight plans:

- 1) Press the **MENU** Key twice.
- 2) Touch **Flight Plan List**.
- 3) Press the **Menu** Key.
- 4) Touch **Import**.
- 5) Touch the desired flight plan.
- 6) Acknowledge flight plan import success or failure by touching **OK**.

Exporting flight plans:

- 1) Press the **MENU** Key twice.
- 2) Touch **Flight Plan List**.
- 3) Touch the desired saved flight plan.
- 4) Touch **Export**.
- 5) Acknowledge flight plan export success/failure by touching **OK**.

SENDING FLIGHT PLANS TO A GNS/GTN

Any flight plan may be sent to a properly connected GNS/GTN device so that it can track the same flight plan.

Sending flight plans:

- 1) From the Active Flight Plan, touch **FPL Source** > **Internal** if an external navigator is configured.
- 2) Press the **MENU** Key.
- 3) Touch **Send to Navigator**.

6.7 APPROACHES (WITHOUT EXTERNAL NAVIGATOR CONFIGURED)



WARNING: Do not use the approach information provided by the VFR navigation database residing within the G3X Touch as a means of navigating any instrument approach. The G3X Touch VFR navigation database is limited to present only the waypoints for the final approach leg of a published procedure. These waypoints and associated course line are made available for monitoring purposes only.



NOTE: This section is not applicable if an external GPS navigator is configured. Approach selection is handled via the external GPS navigator's controls only. Refer to the external GPS navigator's Pilot's Guide for more information.

An approach can be loaded at any airport that has one available, and provides situational awareness for non-precision and precision approaches to airports with published instrument approach procedures. Only one approach can be loaded at a time in a flight plan. If an approach is loaded when another approach is already in the active flight plan, the new approach replaces the previous approach.

Whenever an approach is selected, the choice to either "Load Approach" or "Activate Approach" is given. "Load Approach" adds the approach to the end of the flight plan without immediately using it for navigation guidance. This allows continued navigation via the intermediate waypoints in the original flight plan, but keeps the procedure available on the Active Flight Plan Page for quick activation when needed. "Activate Approach" also adds the procedure to the end of the flight plan but immediately begins to navigate to the first waypoint in the approach.

SELECTING AN APPROACH

When selecting an approach, it replaces the destination airport with the sequence of waypoints for the selected approach. Keep in mind the airport must have a published approach (GPS, RNAV, VOR, NDB, localizer, or ILS) and only the final course segment (final approach fix to missed approach point) of the published approach is available (unless an external navigator is configured).

An approach can be selected from the Saved Flight Plan Page, Active Flight Plan Page, and Direct-to Window, Waypoint (WPT) Page.



NOTE: *The approach airport can be modified from the Select Approach Window (Active Flight Plan Page > MENU > Approach). When this is done, the approach is added but the destination airport is not. When removing an approach (any active or loaded approach to an airport other than the destination airport), the destination airport will be inserted at the end of the flight plan.*

Loading an approach from the saved flight plan page:

- 1) Press the **MENU** Key Twice.
- 2) Touch **Flight Plan List**.
- 3) Touch the desired saved flight plan.
- 4) Touch **Edit**.
- 5) Press the **MENU** Key.
- 6) Touch **Select Approach**.
- 7) Touch  to view a list of approaches.
- 8) Touch the desired approach.
- 9) Touch **Select Approach**.

Loading/Activating an approach from the active flight plan page:

- 1) Press the **MENU** Key.
- 2) Touch **Select Approach**.
- 3) Touch  to view a list of approaches.
- 4) Touch the desired approach.
- 5) Touch **Load Approach**.

Or:

Touch **Activate Approach**.

Viewing a chart for the selected approach:

From the Waypoint Page, touch the **Charts** Tab.

Activating an loaded approach on the Active Flight Plan Page:

- 1) Touch any leg of the loaded approach.
- 2) Touch **Activate Approach**.

Loading/Activating an approach from the Direct-to Window:

- 1) Press the **Direct-to** Key.
- 2) Press the **MENU** Key.
- 3) Touch **Select Approach**.
- 4) If necessary, touch the identifier name.
- 5) Enter the identifier and touch **Enter**.
- 6) Touch  to view a list of approaches.
- 7) Touch the desired approach.
- 8) Touch **Load Approach**.

Or:

Touch **Activate Approach**.

Removing an approach from the Active Flight Plan:

- 1) Press the **MENU** Key.
- 2) Touch **Remove Approach**.

ACTIVATING VECTORS-TO-FINAL

Activate Vectors-to-Final is used when being vectored to the final approach course by Air Traffic Control (ATC).

The G3X Touch creates an extension of the final course, beyond the final approach waypoint in the database (final approach fix [FAF]). On the Active Flight Plan Page, a Vector to Final symbol appears beside the first approach waypoint.



Vectors-to-Final



Vectors-to-Final

The G3X Touch does not provide guidance to the inbound course. The course deviation needle on the graphic HSI remains off-center until established on the final approach course. The map shows an extension of the final approach course using a bold magenta line.

If Activate Vectors-to-Final is not selected, the G3X Touch creates a straight-line course directly to the first waypoint in the approach.

Loading the approach cancels the Direct-to and initiates a route to the FAF.

Activating Vectors-to-Final (Active Approach):

- 1) With an approach 'active' in the Active Flight Plan, press the **MENU** key.
- 2) Touch **Vectors**.

Activating Vectors-to-Final (Loaded Approach):

- 1) With an approach 'loaded' in the Active Flight Plan, touch the **MENU** key.
- 2) Touch the desired approach button (Example: KMCI ILS 01L).
- 3) Touch **Activate Vectors-to-Final**.

Canceling Vectors-to-Final:

- 1) With Vectors-to-Final activated, press the **MENU** Key.
- 2) Touch **Cancel Vectors-to-Final**. Verify the green indicator clears.

SECTION 7 HAZARD AVOIDANCE

7.1 WEATHER INFORMATION

The G3X Touch™ is capable of increasing in-flight situational awareness when considering weather by displaying pertinent information in a variety of locations throughout the system (e.g., Weather Page, Waypoint Information Page, Data Fields, etc.). The G3X Touch system is capable of receiving weather information from a variety of sources and seamlessly switching the displayed information for comparison.

WEATHER SOURCES

On installations that include the capability to receive both SiriusXM and FIS-B weather information, there are three options available for selection through the Main Menu or Weather Page; AUTO, SXM (SiriusXM), and FIS-B. The default selection is 'AUTO.' With AUTO selected, and a SiriusXM subscription, SiriusXM weather information is displayed. If SiriusXM service is unavailable with AUTO selected, FIS-B weather information is displayed, if available. If either SiriusXM or FIS-B source is selected, only the selected source is used to display weather information and no automatic source-switching will occur. Data from the selected weather source will apply to all weather shown on the Map Page, Waypoint Page, Weather Page, Nearest Page, and configurable data fields.

Switching Weather Sources:

- 1) Press the **MENU** Key twice.
- 2) Touch **Setup > Weather**.
- 3) Touch the Weather Data Source.
- 4) Touch **Auto, SiriusXM, or FIS-B**.

Or

- 1) From the Weather Page, press the **MENU** Key.
- 2) Touch **Data Source**.
- 3) Touch **Auto, SiriusXM, or FIS-B**.

DATA LINK WEATHER (OPTIONAL)

System Overview

Flight Instruments



NOTE: See the G3X Touch Installation Manual for Data Link Weather activation instructions.

EIS

DATA LINK WEATHER ADVISORY

Each time the system powers-up, the pilot is prompted to acknowledge a Data link weather advisory.

CNS Interface

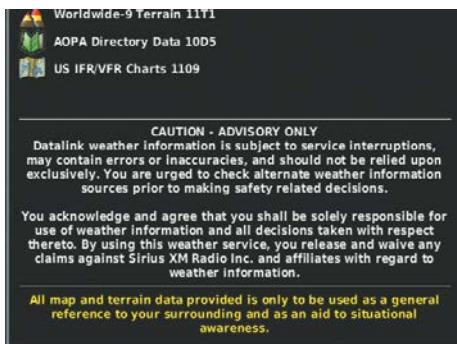

GPS Navigation

Data link Weather Advisory

Flight Planning

Touch **Continue**.

Hazard Avoidance

USING DATA LINK WEATHER PRODUCTS

Additional Features



WARNING: Do not use data link weather information for maneuvering in, near, or around areas of hazardous weather. Information contained within data link weather products may not accurately depict current weather conditions.

AFCs



WARNING: Do not use the indicated data link weather product age to determine the age of the weather information shown by the data link weather product. Due to time delays inherent in gathering and processing weather data for data link transmission, the weather information shown by the data link weather product may be significantly older than the indicated weather product age.

Annun/Alerts

Appendix

Index

Data Link Weather Products can be displayed on the Map Page and individually on the Weather (Wx) Page.

FIS-B

The supported FIS-B radios are designed to receive, process, and output traffic (ADS-B air-to-air, and TIS-B traffic information), and weather (Flight Information Service-Broadcast (FIS-B)) information to the G3X Touch system through an RS-232 serial connection or Bluetooth connection. As a UAT receiver, the FIS-B radios can receive and, when connected to the G3X Touch, display Flight Information Service-Broadcast (FIS-B) weather products as well as traffic.

FIS-B is a subscription-free weather service that is broadcast by Ground Based Transceivers (GBTs) over the 978 MHz UAT frequency band as part of the FAA's Next Generation Air Transportation System (NextGen). To receive FIS-B weather information, the radio must be within range and line-of-sight of an operating GBT. Reception may be affected by altitude, terrain, and other factors.

FIS-B Expiration Time

FIS-B weather broadcasts are updated regularly and may take approximately ten minutes to transmit all available weather data. Therefore, weather data is not immediately available. No pilot action is required to receive FIS-B weather information. Weather product status can be viewed on the dedicated Weather Page, or the Data Link Page from the Tools menu.

When a FIS-B weather product is active on a map, the age of the data is displayed on the screen in the lower left corner. The age of the product is based on the time difference between when the data was assembled on the ground and the current GPS time. Weather products are broadcast at specific intervals (see broadcast interval in the table below).

If, for any reason, a weather product is not refreshed within the Expiration Time intervals (see table), the data is considered expired and is removed from the display. This ensures that only data that is consistent with FIS-B broadcast data is displayed. If more than half of the expiration time has elapsed, the color of the product age displayed changes to yellow. The system displays dashes instead of a product age when a product has expired.

The table below shows the FIS-B weather expiration time and the broadcast interval. The broadcast interval represents the interval at which FIS-B GBTs broadcast new signals that may or may not contain new weather data. It does not represent the rate at which weather data is updated or new content is received.

- System Overview
- Flight Instruments
- EIS
- CNS Interface
- GPS Navigation
- Flight Planning
- Hazard Avoidance
- Additional Features
- AFCS
- Annun/Alerts
- Appendix
- Index

	FIS-B Products	Expiration Time	Update Interval	Broadcast Interval (Minutes)
System Overview				
Flight Instruments	NEXRAD Composite Reflectivity (CONUS)	75 minutes	~5 minutes precipitation mode 10 minutes for clear air	15
EIS	NEXRAD Composite Reflectivity (Regional)	75 minutes	As Available	2.5
CNS Interface	Cloud Tops Forecast	105 minutes	1 hour	15
GPS Navigation	Winds and Temperatures Aloft	12 hours	12 hours	10
Flight Planning	Lightning	75 minutes	5 minutes	5
Hazard Avoidance	METAR	8 hours	1 minute (where available), As Available otherwise	5
Additional Features	TAF	12 hours	8 hours	10
AFCs	CWA (Center Weather Advisory)	2 hours	As Necessary	10
Annun/Alerts	G-AIRMET (Graphical AIRMET)	12 hours	6 hours	5
Appendix	SIGMET	12 hours	As Available, then at 15 minute intervals for 1 hour	5
Index	PIREP	4 hours	As Available	10
	NOTAM (D)/FDC (Including TFRs)	12 hours	As Available	10
	Turbulence Forecast	105 minutes	1 hour	15
	Icing Forecast	105 minutes	1 hour	15

Weather Product Timing

Viewing Ground Station Status:

- 1) Press the **MENU** Key twice to display the Main Menu.
- 2) Touch Data Link.
- 3) Press the **MENU** Key.
- 4) Touch **Ground Stations**.

SIRIUSXM

Before SiriusXM Weather can be used, the service must be activated. Service is activated by providing SiriusXM Satellite Radio with a Radio ID.

SiriusXM Satellite Radio uses the Radio ID to send an activation signal that allows the G3X Touch to display weather data and/or entertainment programming.

SXM Weather Information

- Radio ID—Eight-digit ID number used for activation.
- Service Level—SiriusXM Weather subscription plan purchased.
- Weather Products—List of weather features and age of weather data in minutes.

Accessing Data Link Weather information:

From the Weather (Wx) Page, press the **MENU** Key and touch **More Info...**

DATA LINK WEATHER SETUP

The setup menu for the Map Page controls the map range settings above which weather products are decluttered from the display. If a map range larger than the weather product map range setting is selected, the weather product data is removed from the map. For weather products such as Lightning, and Storm Cells, the weather product is displayed when a map range "smaller" than the weather product map range setting is selected (Cloud Tops works inversely). The menu also provides a means for enabling/disabling display of weather products on the Map Page.

Additional information about many of the weather products can be displayed by touching the weather product on the Weather Page or the Map Page:

Viewing Data Link Weather products on the Map Page:

- 1) From the Map Page, press the **MENU** Key.
- 2) Touch Weather.
- 3) Touch the desired weather product on the map.
- 4) With the weather product selected, touch the Map Feature Button to display additional information.

Viewing Data Link Weather products on the Weather (Wx) Page:

- 1) From the Wx Page, touch the desired weather product on the map.
- 2) With the weather product selected, touch the Map Feature Button to display additional information.

Setting up and customizing weather data for the Map Page:

- 1) From the Map Page, press the **MENU** Key.
- 2) Touch **Set Up Map**.
- 3) Scroll the tabs left/right or up/down if necessary.
- 4) Touch the **Weather Tab**.
- 5) Touch  to view a list of options (**On, Off, Auto, range settings**, etc.).
- 6) Touch the desired option for each weather product.

Restoring default weather data for the Map Page:

- 1) From the Map Page, press the **MENU** Key.
- 2) Touch **Set Up Map**.
- 3) Touch the **Weather Tab**.
- 4) Press the **MENU** Key.
- 5) Touch **Restore Category Defaults**.

Viewing legends for displayed weather products:

- 1) From the Wx Page, press the **MENU** Key.
- 2) Touch **Weather Legend**.
- 3) Touch  to cycle through the weather products.

Or

- 1) From the Map Page, press the **MENU** Key.
- 2) Touch **More**.

- 3) Touch **Weather Legend**.
- 4) Touch  to cycle through the weather products.

Animating weather:

- 1) From the Map Page or the Wx Page, press the **MENU** Key.
- 2) Touch **Animate Weather**.

WEATHER PRODUCTS

Weather Product	SiriusXM Weather (products vary by subscription)	FIS-B Weather (Subscription-free)
NEXRAD Radar (CONUS) Base and Composite Reflectivity	+	
NEXRAD Radar (CONUS low resolution)		+
NEXRAD Radar (Regional high resolution)		+
NEXRAD Radar (Canada)	+	
Cloud Tops	+	
Cloud Tops Forecast		+
Surface Precipitation	+	
Surface Analysis	+	
Sea Surface Temperatures	+	
Echo Tops	+	
Surface Pressure	+	
Lightning	+	+
Storm Cells	+	
METAR (US)	+	+
METAR (Canada)	+	
TAF (US) *	+	+
TAF (Canada)	+	
CWA (Center Weather Advisories)		+

Weather Product	SiriusXM Weather (products vary by subscription)	FIS-B Weather (Subscription-free)
AIRMET	+	
G-AIRMETs (Graphical AIRMETs)		+
SIGMET	+	+
PIREP	+	+
Winds Aloft	+	+
Temperatures Aloft	+	+
NOTAMs *		+
Temporary Flight Restrictions	+	+
Freezing Level	+	
Turbulence Forecast	+	+
Icing Forecast	+	+
* Only available from the Waypoint Page		

Supported Weather Products by Source

NEXRAD RADAR

NEXRAD (NEXt-generation RADar), is a network of multiple high-resolution Doppler radar sites that are operated by the National Weather Service (NWS). NEXRAD data provides centralized meteorological information for the continental United States and selected overseas locations. The maximum range of a single NEXRAD radar site is 250 nm. In addition to a wide array of services, the NEXRAD network provides important information about severe weather and air traffic safety.

NEXRAD data is not real-time. The lapsed time between collection, processing, and dissemination of NEXRAD images can be significant and may not reflect the current radar synopsis. Due to the inherent delays and the relative age of the data, it should be used for long-range planning purposes only. Never use NEXRAD data or any radar data to penetrate hazardous weather. Rather, use it in an early-warning capacity of pre-departure and enroute evaluation.

Composite data from all the NEXRAD radar sites in the United States is shown. This data is composed of the maximum reflectivity from the individual radar sweeps. The display of the information is color-coded to indicate the weather severity level.

The display of radar coverage is always active when NEXRAD is selected. Areas where NEXRAD radar coverage is not currently available or is not being collected are indicated in grayish-purple.

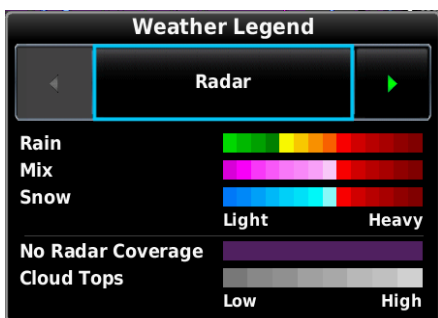

NEXRAD Weather Legend (SiriusXM)

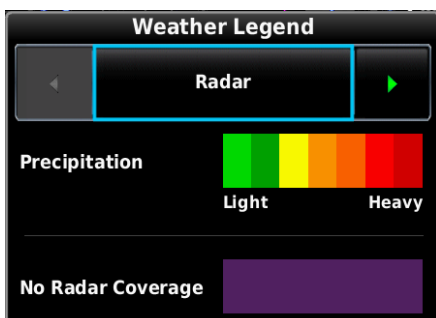

NEXRAD Weather Legend (FIS-B)

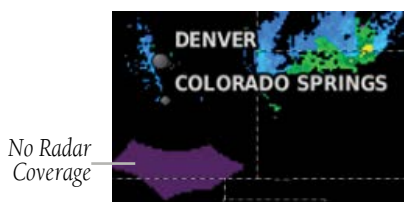

NEXRAD No Radar Coverage

NEXRAD Abnormalities

There are possible abnormalities regarding displayed NEXRAD images. Some, but not all, of those include:

- Ground clutter
- Strokes and spurious radar data
- Sun strokes, when the radar antenna points directly at the sun
- Military aircraft deploy metallic dust (chaff) which can cause alterations in radar scans

- Interference from buildings or mountains, which may cause shadows

NEXRAD Limitations

Certain limitations exist regarding the NEXRAD radar displays. Some, but not all, are listed for the user's awareness:

- NEXRAD base reflectivity does not provide sufficient information to determine cloud layers or precipitation characteristics (hail vs. rain). For example, it is not possible to distinguish between wet snow, wet hail, and rain.
- NEXRAD base reflectivity is sampled at the minimum antenna elevation angle. An individual NEXRAD site cannot depict high altitude storms at close ranges, and has no information about storms directly over the site.
- Radar coverage only extends to 55°N.
- Any precipitation displayed between 52°N and 55°N is unknown.

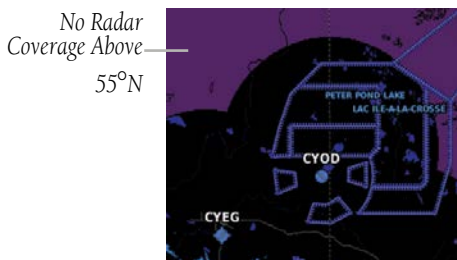

NEXRAD Radar Coverage Limitations

Reflectivity

Reflectivity is the amount of transmitted power returned to the radar receiver. Colors on the NEXRAD display directly correlate to the level of detected reflectivity. Reflectivity as it relates to hazardous weather can be very complex. The role of radar is essentially to detect moisture in the atmosphere. Simply put, certain types of weather reflect radar better than others. The intensity of a radar reflection is not necessarily an indication of the weather hazard level. For instance, wet hail returns a strong radar reflection, while dry hail does not. Both wet and dry hail can be extremely hazardous.

System Overview

Flight Instruments

EIS

CNS Interface

GPS Navigation

Flight Planning

Hazard Avoidance

Additional Features

AFCs

Annun/Alerts

Appendix

Index

NEXRAD Intensity

Colors are used to identify the different NEXRAD echo intensities (reflectivity) measured in dBZ (decibels of Z). "Reflectivity" (designated by the letter Z) is the amount of transmitted power returned to the radar receiver. The dBZ values increase as returned signal strength increases. Precipitation intensity is displayed using colors corresponding to the dBZ values.



NEXRAD Data (SiriusXM)



NEXRAD Data (FIS-B)

FIS-B Radar Products

FIS-B weather provides two different Radar products, CONUS and Regional. The system can display each individually or a composite (COMBINED). When Regional Radar is displayed, only precipitation for your current region is displayed. The subdued (grayish-purple colored) area represents the area not covered by the regional radar product. When Combined radar data is viewed, Regional Radar data is displayed on top of CONUS data and the time shown in the lower left corner is associated with Regional Radar data only.

CLOUD TOPS

Satellite observation of clouds is represented as temperature data, where colder tops are typically found at higher altitudes. This temperature data is transformed into cloud top height contours, indicating the height of the cloud top in 5,000 foot increments.



Cloud Tops Data

CLOUD TOPS FORECAST

Cloud Tops Forecast data displays forecasted cloud top heights. Heights are indicated in 1,500 foot increments from 1,500 feet up to 15,000 feet and in 3,000 foot increments from 15,000 feet up to 24,000 feet.

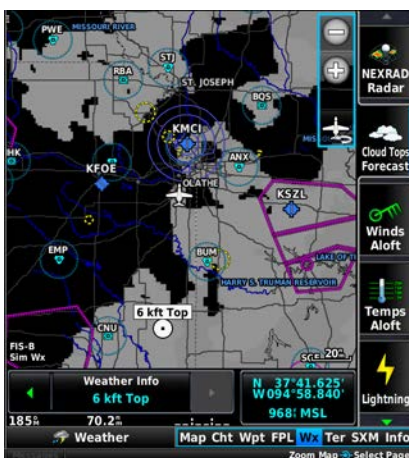

Cloud Tops Forecast Data

ECHO TOPS

Echo Tops are derived from NEXRAD radar and indicate the highest altitude at which precipitation is falling. Echo Tops at or above the altitude you select are displayed, in 5,000 foot increments up to 70,000 ft. Echo Tops can be helpful in determining the severity of thunderstorms.



Echo Tops Data

WINDS ALOFT

Winds Aloft data shows the forecasted wind speed and direction at the surface and at selected altitudes. Altitudes can be displayed in 3,000-foot increments up to 42,000 feet MSL.

Winds Aloft are displayed using wind barbs or a wind streamline depending on the selected range. The wind barbs indicate wind speed and direction. The wind streamline indicates wind direction with arrows.

The wind barbs always point in the direction the wind is coming from. The wind speed is depicted using flags at the end of the wind barb. A short wind flag is 5 knots, a long wind flag is 10 knots, and a triangle flag is 50 knots.



Winds Aloft Data

SURFACE PRESSURE

This feature displays pressure isobars and pressure centers. The isobars connect points of equal pressure. Pressure readings can help determine weather and wind conditions. High pressure areas are generally associated with fair weather. Low pressure areas are generally associated with clouds and the chance of precipitation. Isobars that are packed closely together show a strong pressure gradient. Strong gradients are associated with areas of stronger winds. Pressure units can be displayed in Millibars (mb) or Inches of Mercury (in).



Surface Pressure Data

LIGHTNING

Lightning data shows the approximate location of cloud-to-ground lightning strikes. A strike icon represents a strike that has occurred within a two-kilometer region and within the last seven minutes. The exact location of the lightning strike is not displayed.



Lightning Data

METARs AND TAFs







NOTE: METAR information is only displayed within the installed aviation database service area.

METAR (METeoroological Aerodrome Report) is an international code used for reporting weather observations. METARs are updated hourly or as needed. METARs typically contain information about the temperature, dewpoint, wind, precipitation, cloud cover, cloud heights, visibility, and barometric pressure. They can also contain information on precipitation amounts, lightning, and other critical data. If METAR data is available for an airport, a color-coded flag is shown next to the airport.

TAF (Terminal Area Forecast) is the standard format for 24-hour weather forecasts. TAFs may contain some of the same code as METAR data. It typically forecasts significant weather changes, temporary changes, probable changes, and expected changes in weather conditions. TAF information is only available from the Waypoint Page.

METAR data is displayed on the Map Page and the Weather (WX) Page. An abbreviated version can be viewed by touching the METAR flag. Touching the identifier name displays additional information.

The METAR flag color is determined by the information in the METAR text.

-  VFR (ceiling greater than 3000 feet AGL and visibility greater than 5 miles)
-  Marginal VFR (ceiling 1000-3000 feet AGL and/or visibility 3-5 miles)
-  IFR (ceiling 500 to below 1000 feet AGL and/or visibility 1 mile to less than 3 miles)
-  Low IFR (ceiling below 500 feet AGL or visibility less than 1 mile)
-  METAR text does not contain adequate information to determine flight conditions



METAR Data

CENTER WEATHER ADVISORIES (CWAs)

Center Weather Advisories are unscheduled bulletins to warn pilots of conditions that meet or are approaching not previously forecast AIRMET, SIGMET, or Convective SIGMET criteria. CWAs are valid for up to two hours and if a forecaster determines it's warranted, they may be issued hourly for convective activity.



Center Weather Advisory Data

AIRMETS

An AIRMET (AIRmen's METeorological Information) can be especially helpful for pilots of light aircraft that have limited flight capability or instrumentation. An AIRMET must affect or be forecast to affect an area of at least 3,000 square miles at any one time. AIRMETS are routinely issued for six-hour periods and are amended as necessary due to changing weather conditions. AIRMETS are displayed as colored, dashed lines.



AIRMET Data

GRAPHICAL AIRMETS



NOTE: Graphical AIRMETS are only available when using the FIS-B weather source.

A Graphical AIRMET (AIRmen's METeorological Information) can be especially helpful for pilots of light aircraft that have limited flight capability or instrumentation. A Graphical AIRMET must affect or be forecast to affect an area of at least 3,000 square miles at any one time. Graphical AIRMETS are routinely issued for six-hour periods and are amended as necessary due to changing weather conditions. Graphical AIRMETS are displayed as colored, dashed lines.



Graphical AIRMET Data

SIGMETs

A SIGMET (SIGNificant METeorological Information) advises of weather that is potentially hazardous to all aircraft. In the contiguous United States, the following items are covered: severe icing, severe or extreme turbulence, volcanic ash, dust storms, and sandstorms that lower visibility to less than three statute miles.

A Convective SIGMET is issued for the following conditions: thunderstorms, isolated severe thunderstorms, embedded thunderstorms, hail at the surface, and tornadoes.

A SIGMET is widespread and must affect or be forecast to affect an area of at least 3,000 square miles. SIGMETs are displayed as a yellow-dashed line.

TEMPORARY FLIGHT RESTRICTIONS (TFR)



NOTE: Do not rely solely upon data link services to provide Temporary Flight Restriction (TFR) information. Always confirm TFR information through official sources such as Flight Service Stations or Air Traffic Control.

Temporary Flight Restrictions, or TFRs, temporarily restrict all aircraft from entering the selected airspace unless a waiver has been issued. TFRs are routinely issued for activities such as sporting events, dignitary visits, military depots, and forest fires. TFRs are represented as an area highlighted by red (active) or yellow (not yet active).

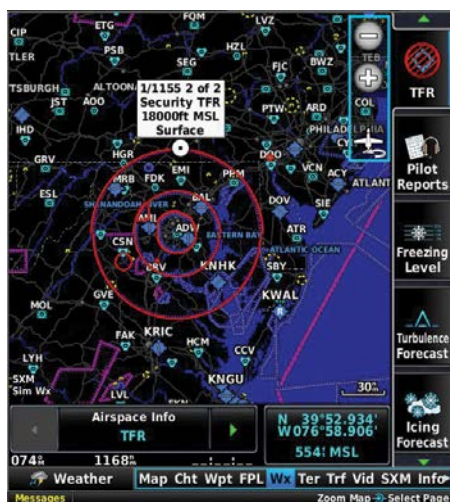

TFR Data

- System Overview
- Flight Instruments
- EIS
- CNS Interface
- GPS Navigation
- Flight Planning
- Hazard Avoidance
- Additional Features
- AFCs
- Annun/Alerts
- Appendix
- Index

PIREPs

Pilot Weather Reports (PIREPs) provide timely weather information for a particular route of flight. When significant weather conditions are reported or forecast, Air Traffic Control (ATC) facilities are required to solicit PIREPs. A PIREP may contain unforecast adverse weather conditions, such as low in-flight visibility, icing conditions, wind shear, and turbulence. PIREPs are issued as either Routine (UA) or Urgent (UUA).



PIREP Data

PIREP TYPE	Icons	Description
Icing		Negligible Icing
		Trace Icing
		Trace to Light Icing
		Light Icing
		Light to Moderate Icing
		Moderate Icing
		Moderate to Severe Icing
		Severe Icing

- System Overview
- Flight Instruments
- EIS
- CNS Interface
- GPS Navigation
- Flight Planning
- Hazard Avoidance**
- Additional Features
- AFCS
- Annun/Alerts
- Appendix
- Index

PIREP TYPE	Icons	Description
Sky Conditions		Unknown Sky Condition
		Sky Clear
		Few Clouds
		Scattered Clouds
		Broken Clouds
		Overcast
		IMC
Turbulence		Turbulence Negligible or Smooth
		Light Turbulence
		Light to Moderate Turbulence
		Moderate Turbulence
		Moderate to Severe Turbulence
		Severe Turbulence
		Extreme Turbulence

PIREP Icons

FREEZING LEVELS

Freezing Level shows contours for the lowest forecast altitude where icing conditions are likely to occur.



Freezing Level Data

TURBULENCE FORECAST

Turbulence data identifies the potential for erratic movement of high-altitude air mass associated winds. Turbulence is classified as light, moderate, severe, or extreme. Turbulence data is intended to supplement AIRMETs and SIGMETs.



Turbulence Data

ICING FORECAST (CIP & SLD)

Current Icing Product (CIP) data shows a graphical view of the current icing environment. SiriusXM icing severity is displayed in three categories: light, moderate, and heavy (not specific to aircraft type). FIS-B icing severity is displayed in four categories: trace, light, moderate, and heavy (not specific to aircraft type). The CIP product is not a forecast, but a representation of the current conditions at the time of the analysis.

Supercooled Large Droplet (SLD) icing conditions are characterized by the presence of relatively large, super cooled water droplets indicative of freezing drizzle and freezing rain aloft. SLD threat areas are depicted as magenta dots over the CIP colors.

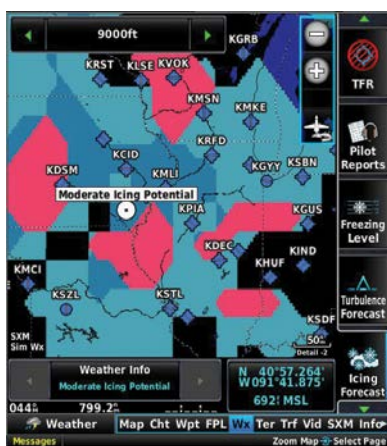

Icing Data

LIGHTNING DETECTOR



WARNING: Do not rely on information from the lightning detection system display as the sole basis for hazardous weather avoidance. Range limitations and interference may cause the system to display inaccurate or incomplete information. Refer to documentation from the lightning detection system manufacturer for detailed information about the system.



NOTE: Lightning detector data cannot be displayed simultaneously with data link lightning weather products on the same map.

Lightning Detector data provides lightning cell and strike information on the PFD inset map (GDU™ 460 only) and navigation map using the lightning symbology. Lightning strike symbols appear the same size for the first minute and gradually fade away over the following two minutes.

The Lightning Detector operates in either Cell Mode or Strike Mode. When operating in Cell Mode, the system displays clusters or cells of electrical activity. When operating in Strike Mode, the system displays the approximate location of individual lightning strikes.



NOTE: Lightning Detection settings made on the Map Page are similarly reflected for the PFD inset map (GDU 460 only) if enabled.

Enabling/disabling Lightning Detection:

- 1) From the Map Page press the **MENU** Key.
- 2) Touch **Set Up Map**.
- 3) Scroll the tabs left or right if necessary.
- 4) Touch the **Lightning Tab**.
- 5) Touch  under Lightning Detector Data **On** or **Off** as desired.

Or

- 1) From the Map Page, press the **MENU** Key.
- 2) Touch **Lightning Detector** to toggle on or off as desired.

Selecting a Lightning Detection mode:

- 1) From the Map Page press the **MENU** Key.
- 2) Touch **Set Up Map**.
- 3) Scroll the tabs left or right if necessary.
- 4) Touch the **Lightning Tab**.
- 5) Touch  under Lightning Detector Mode and select **Strike** or **Cell** as desired.

Selecting a Lightning Detection map range:

- 1) From the Map Page press the **MENU** Key.
- 2) Touch **Set Up Map**.
- 3) Scroll the tabs left or right if necessary.
- 4) Touch the **Lightning Tab**.
- 5) Touch  under Lightning Detector Symbol and select a desired map range setting from the list.

Clearing the Navigation Map removes any previously displayed cell or lightning strike information from the navigation maps.

Clearing Lightning Detection information from Navigation Map:

- 1) From the Map Page press the **MENU** Key.
- 2) Touch **Set Up Map**.
- 3) Scroll the tabs left or right if necessary.
- 4) Touch the **Lightning Tab**.
- 5) Touch **Clear Strikes**.

SURFACE ANALYSIS

Surface Analysis data is available for current and forecast weather conditions. Forecasts are available for intervals of 12, 24, 36, 48, 72, and 96 hours.



Surface Analysis Data Selected

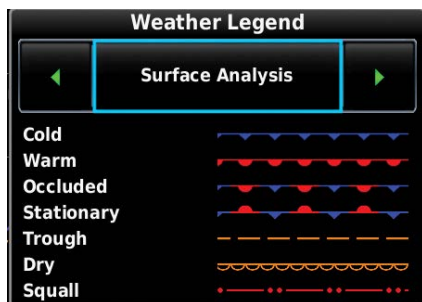

Surface Analysis Legend

- System Overview
- Flight Instruments
- EIS
- CNS Interface
- GPS Navigation
- Flight Planning
- Hazard Avoidance
- Additional Features
- AFCs
- Annun/Alerts
- Appendix
- Index

7.2 TERRAIN



WARNING: Do not use Terrain information for primary terrain avoidance. Terrain information is intended only to enhance situational awareness.



NOTE: Terrain data is not displayed when the aircraft is outside the installed terrain database coverage area.



NOTE: Terrain depicted in the Profile View is always “ahead” of the aircraft, and will change as ground track changes.

The Terrain Page displays altitudes of terrain and obstructions relative to the aircraft position and altitude with reference to a database that may contain inaccuracies. Terrain and obstructions are shown only if they are in the database. Terrain and obstacle information should be used as an aid to situational awareness. They should never be used to navigate or maneuver around terrain.

Note that all obstructions may not be available in the terrain and obstacle database. No terrain and obstacle information is shown without a valid 3-D GPS position.

The G3X Touch GPS receiver provides the horizontal position and altitude of the aircraft. Aircraft GPS altitude is derived from satellite position. GPS altitude is then converted to a mean sea level (MSL)-based altitude (GPS-MSL altitude) and is used to determine terrain and obstacle proximity. GPS-MSL altitude accuracy is affected by satellite geometry, but is not subject to variations in pressure and temperature that normally affect pressure altitude sensors. GPS-MSL altitude does not require local altimeter settings to determine MSL altitude. It is a widely-used MSL altitude source.

Terrain and obstacle databases are referenced to MSL. Using the GPS position and altitude, the Terrain feature portrays a 2-D picture of the surrounding terrain and obstacles relative to the position and altitude of the aircraft. GPS position and GPS-MSL altitude are used to calculate and predict the aircraft’s flight path in relation to the surrounding terrain and obstacles. In this way, the pilot can view predicted dangerous terrain and obstacle conditions.

Alert windows appear on all pages (except the Terrain (Ter) Page) to inform the pilot of proximity to the terrain and obstacles, as well as an unsafe descent rate. These alerts depend on user-defined parameters in the Terrain Page setup.

SYNTHETIC VISION

Terrain is integrated within Synthetic Vision (when active) to provide land contours (colors are consistent with those of the topographical map display), large water features, towers, obstacles over 200' AGL, as well as visual and auditory alerts to indicate the presence of terrain and obstacle threats relevant to the projected flight path. Synthetic Vision terrain information is displayed in red and yellow shading on the PFD. Refer to Section 8.1 (Synthetic Vision) for more information.

TERRAIN INFORMATION

The areas of the terrain shaded red are predicted to be within 100 feet below or above the aircraft. The yellow terrain areas are between the user-defined Caution Elevation and 100 feet below the aircraft. By default, the Caution Elevation is 1,000 feet; therefore, the areas in yellow are between 1,000 feet and 100 feet below the aircraft. The black areas are further than the Caution Elevation. A projected point of impact is marked with an "X" symbol.

Enabling/disabling Terrain Shading on the Map Page:

From the Map Page, press **MENU**, then touch **Terrain**.

TERRAIN VIEWS

Two views are displayed on the Terrain (Ter) Page: the Map View, and the Profile View.

Yellow Terrain is Between the User-defined Caution Elevation and 100 ft Below the Aircraft

Map View

Obstacle

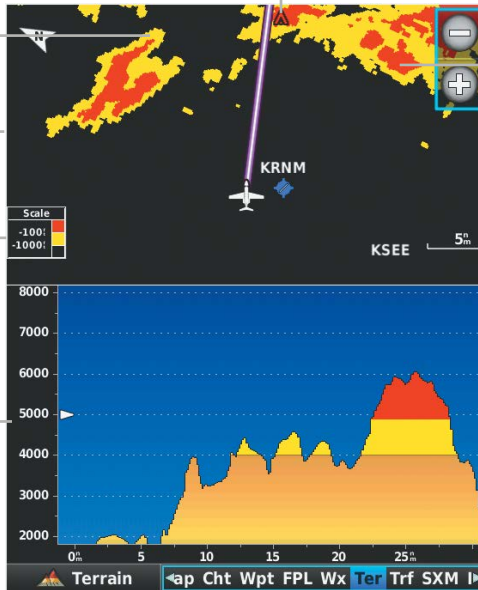

Red Terrain is above the aircraft, or within 100 ft below the aircraft.

Terrain Legend

Profile View

Terrain (Ter) Page



NOTE: When on the ground, the terrain color scale changes so no yellow is shown, and the red band starts at 400 feet above the aircraft. This allows the pilot to quickly identify threatening terrain while on the ground. After the aircraft is airborne, the terrain display reverts to normal.











- System Overview
- Flight Instruments
- EIS
- CNS Interface
- GPS Navigation
- Flight Planning
- Hazard Avoidance
- Additional Features
- AFCs
- Annun/Alerts
- Appendix
- Index

OBSTACLE INFORMATION

Obstacles are shown on the Terrain Page at or below the map range of 12 nm. Obstacles are also shown on the Map Page when the map range is set to 3 nm or below.

Standard aeronautical chart symbols are used for lighted or unlighted obstacles taller than 200 feet Above Ground Level (AGL). Refer to the Obstacle Icons legend below.

Each obstacle is labeled with the altitude of the top of the obstacle, or Mean Sea Level (MSL). Each obstacle also lists, in parentheses, the actual height of the obstacle, or Above Ground Level (AGL).

Unlighted Obstacle		Lighted Obstacle		Potential Impact Points	Obstacle Location
< 1000' AGL	> 1000' AGL	< 1000' AGL	> 1000' AGL		
					WARNING: Red obstacle is above or within 100' below current aircraft altitude
					CAUTION: Yellow obstacle is between 100' and 1000' (default) below current aircraft altitude

Terrain Obstacle Colors and Symbology

TERRAIN SETTINGS

Use the terrain settings to set levels for terrain alerts as well as obstacles in or near your flight path.

- Caution Elevation—The G3X Touch will provide an alert if the terrain or obstacle is within the default Caution Elevation or user-defined Caution Elevation.

- **Look Ahead Time**—Determines the maximum time when an alert annunciation occurs. For example, if 120 seconds is selected, the G3X Touch provides an alert up to 120 seconds before you reach the terrain or obstacle.
- **Alert Sensitivity**—The three Alert Sensitivity settings (Terrain, Obstacles, and Descent Rate) determine what level of alerts are annunciated. The G3X Touch defaults to 'High' sensitivity, which annunciates all red and yellow alerts at the time set in Look Ahead Time. 'Medium' sensitivity annunciates all of the red and the highest priority of yellow alerts. 'Low' only annunciates red alerts. 'Off' disables the alert.

Accessing the terrain settings:

- 1) From the Terrain Page, press the **MENU** Key.
- 2) Touch **Caution Elevation** and touch **500ft Below**, **750ft Below**, or **1000ft Below**.

Or:

Touch **Look Ahead Time** and touch **60 Seconds**, **90 Seconds**, or **120 Seconds**.

Or:

Touch **Alert Sensitivity...** > **Terrain**, **Obstacles**, or **Descent Rate** > **Off**, **Low**, **Medium**, or **High**.

Or:

Touch **Alerts** to toggle between **Enabled** and **Inhibited**.

Or:

Touch **Profile View** to toggle on and off.

TERRAIN ALERTS

Terrain, Obstacle, and Descent Rate Alerts are issued when flight conditions meet parameters that are set within the software algorithms. Terrain alerts typically employ a CAUTION or a WARNING alert severity level, or both. When an alert is issued, visual annunciations are displayed and aural alerts are simultaneously issued. When the aircraft descends through 500 feet above the destination airport or user waypoint (saved as an airport symbol) an audible "Five Hundred" altitude reminder occurs.

If the Terrain Page is not displayed, a pop-up alert appears in the lower left corner of the page. The Range Rings on the pop-up alert are spaced every whole mile/kilometer/nautical mile. Touch the alert to acknowledge the pop-up and/or aural alert.

Terrain and obstacle annunciations appear on the PFD in the upper left corner of the Attitude Indicator. Arrows are depicted on the terrain and obstacle annunciations if terrain is outside the Synthetic Vision field of view.

Arrows indicate the terrain is outside the Synthetic Vision field of view.



Terrain Annunciation on PFD

Enabling/disabling terrain alerts:

- 1) From the Terrain Page, press the **MENU** Key.
- 2) Touch **Alerts** to toggle between **Enabled** and **Inhibited**.

AURAL ALERTS

- “Five Hundred”—when the aircraft descends through 500 feet above the destination airport or user waypoint (saved as an airport symbol).

The following aural terrain alerts are issued when flight conditions meet parameters that are set within the software algorithms, and are dependent on the sensitivity level set in the Terrain Setup Menu.

Alert Severity	Terrain	Obstacle	Descent Rate
Caution	“caution, terrain” “caution, terrain ahead”	“caution, obstacle” “caution, obstacle ahead”	“caution, sink rate”
Warning	“terrain ahead! pull up!” “terrain! terrain! pull up! pull up!”	“obstacle ahead! pull up!” “obstacle! obstacle! pull up! pull up!”	“sink rate, pull up!” “pull up!”

Aural Alerts Summary

- System Overview
- Flight Instruments
- EIS
- CNS Interface
- GPS Navigation
- Flight Planning
- Hazard Avoidance**
- Additional Features
- AFCs
- Annun/Alerts
- Appendix
- Index



PFD Terrain Alert



MFD Terrain Alerts

Pop-up Alert

7.3 TRAFFIC SYSTEMS

TRAFFIC SOURCE

The G3X Touch is compatible with three different traffic sources; TIS-A traffic via a Garmin Mode S Transponder, TAS/TCAS I via a GTS 8XX, or ADS-B/TIS-B traffic via a compatible ADS-B device. When the G3X Touch system is configured with both a Mode S transponder capable of receiving TIS-A traffic and a compatible device capable of receiving ADS-B/TIS-B traffic the G3X Touch will automatically switch between traffic sources. The following conditions describe the traffic display logic.

- If the GTX is not receiving TIS-A traffic data, GDL® ADS-B traffic will be displayed.
- If the GDL is receiving both air-to-air ADS-B traffic data and ground uplink TIS-B traffic, then the GDL ADS-B traffic will be displayed.

- If the GTX is receiving TIS-A traffic, and the GDL is not receiving ground uplink TIS-B traffic, then GTX TIS-A traffic will be displayed.

The current traffic source and altitude filter is annunciated in the upper left hand corner of the Traffic Page (TRF).

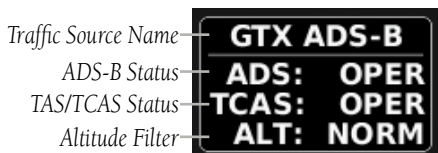

Traffic Source Annunciations

Traffic Source*	States	Description
ADS: TAS/TCAS**:	FAIL	Failed
	STBY	Standby
	UNAVL	Unavailable
	TEST	Self-Test
	OPER	Operating

*ADS and TAS/TCAS are dynamically displayed depending on whether the active traffic device is capable of reporting a state for it.

**The TCAS prefix will always be displayed, except in the case where the traffic device can be specifically identified as a TAS model.

Traffic Source (ADS, TAS/TCAS) States

Altitude Filtering Mode	Description
UNR	Unrestricted
NORM	Normal
ABV	Above
BLW	Below

Altitude Filtering Modes

TRAFFIC PRIORITIZATION

The G3X Touch supports multiple traffic receivers and automatically prioritizes these devices.

The following are the traffic receivers in order of priority:

- TAS/TCAS I (e.g., GTS or non-Garmin) configured with a GTX 345/345R/45R device.
- GTS 8XX device
- GTX 345/345R, GNX™ 375 devices
- GDL device receiving both air-to-air and TIS-B
- GTX 330ES device receiving TIS-A
- GDL device receiving only air-to-air

The G3X Touch is capable of device switching in the event that a device becomes unavailable.

TRAFFIC INFORMATION SERVICE (TIS-A) (OPTIONAL)



NOTE: Refer to Appendix E for general information regarding Traffic Information Service (TIS-A).

SYSTEM STATUS

The traffic system status is annunciated in the upper right corner of the Map Page.

System Status	Traffic Icon
Operating	
No Traffic Data Available	

If a Traffic Icon is not displayed, check the Map Page range and/or the Traffic Display Range on the Map Set Up menu.



Traffic Modes

TRAFFIC SYMBOLOGY

Traffic is shown on the G3X Touch according to TCAS symbology, graphically shown on the Traffic Page (Optional), Map Page, in the Traffic Warning Window, and Synthetic Vision.

A Proximity Advisory (PA) indicates the intruding aircraft is within ± 1200 feet and is within a 5 nm range, but is still not considered a threat.

A Traffic Advisory (TA) symbol appears as a solid yellow circle. All other traffic within range is shown as a hollow white diamond. Altitude deviation from own aircraft altitude is shown above the target symbol if traffic is above own aircraft altitude, and below the symbol if they are below own aircraft altitude. Altitude trend is shown as an up arrow ($>+500$ ft/min), down arrow (<-500 ft/min), or no symbol if less than 500 ft/min rate in either direction.

TIS-A Symbol	Description
	Non-Threat Traffic
	Proximity Advisory (PA)
	Traffic Advisory (TA)

Traffic Symbols

TRAFFIC ANNUNCIATIONS

The G3X Touch displays traffic symbolically on the Map Page, and the Traffic Warning Window (Inset Map) in the lower left corner of the GDU 460 MFD display.

When a traffic advisory (TA) is detected, the following automatically occur:

- The Traffic Warning Window (Inset Map) is enabled and displays traffic (GDU 460 Only).
- A flashing black-on-yellow 'TRAFFIC' annunciation will appear in the upper right corner of the Attitude Indicator for five seconds and remains displayed until no TAs are detected in the area.
- A single "Traffic" voice alert is generated

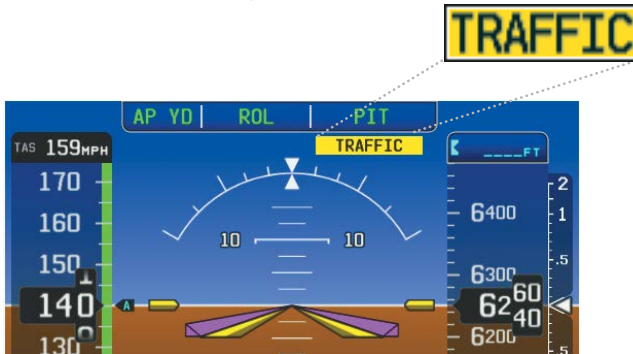

Traffic Alerts

Arrows are depicted on the traffic message if traffic is outside the Synthetic Vision field of view. The arrow points in the direction of the traffic.



Traffic Outside the Synthetic Vision Field of View (PFD)

TRAFFIC VOICE ALERTS

A traffic voice alert is generated whenever the number of Traffic Advisories on the G3X Touch screen increases from one scan to the next. Limiting Traffic Advisories only reduces the “nuisance” alerting due to proximate aircraft. For example, when the first Traffic Advisories appear on the TIS-A display, the user is alerted audibly. So long as a single aircraft remains on the traffic display, no further voice alert is generated. If a second (or more) aircraft appears on the screen, a new voice alert is sounded.

If the number of Traffic Advisories on the traffic display decreases and then increases, a new voice alert is sounded. The traffic voice alert is also generated whenever traffic becomes available. The following traffic voice alerts are available:

- “Traffic”—Traffic alert received.
- “Traffic Not Available”—Traffic service is not available or out of range.

Enabling/disabling traffic alerts:

- 1) Touch the Page Navigation Bar.
- 2) Touch **Traffic**.
- 3) Press the **MENU** Key.
- 4) Touch **Alerts** to toggle between **Enabled** and **Inhibited**.

TRAFFIC WARNING WINDOW

When a traffic threat is imminent, the Traffic Warning Window is shown. The Traffic Warning Window shows a small pop-up map in the lower left corner. The Range Rings on the pop-up alert are spaced every whole mile/kilometer/nautical mile.

- System Overview
- Flight Instruments
- EIS
- CNS Interface
- GPS Navigation
- Flight Planning
- Hazard Avoidance
- Additional Features
- AFCs
- Annun/Alerts
- Appendix
- Index



Traffic Warning Window



NOTE: The Traffic Warning Window is disabled when the aircraft ground speed is less than 30 knots or when on the approach leg of a route.

TRAFFIC GROUND TRACK

Traffic ground track is indicated on the G3X Touch screen by a “target track vector,” a short line shown in 45-degree increments, extending in the direction of target movement.

DISPLAYING TRAFFIC DATA

Traffic is displayed by default on the Map Page and the Traffic Warning Window.

Traffic information is also displayed on the PFD when Synthetic Vision is enabled. See the ‘Additional Features’ Section for more information.

Displaying Traffic information:

Touch the traffic on the map to display range and altitude separation information.



Traffic (Map Page)

Enabling/disabling traffic data on the Map Page:

- 1) From the Map Page, press the **MENU** Key.
- 2) Touch **Traffic**.

Enabling/disabling traffic on the Synthetic Vision display:

- 1) Touch the HSI or Attitude Indicator.
- 2) Touch **More Options**.
- 3) Touch and drag to scroll down.
- 4) Touch **Traffic** to deselect it.

DEDICATED TRAFFIC PAGE (TRF)

Enabling/disabling the traffic alerts:



NOTE: Traffic alerts are reset to 'enabled' on the next power cycle.

- 1) From the Traffic (Trf) Page, press the **MENU** Key.
- 2) Touch **Alerts** to toggle between **Inhibit** and **Enable**.

- System Overview
- Flight Instruments
- EIS
- CNS Interface
- GPS Navigation
- Flight Planning
- Hazard Avoidance
- Additional Features
- AFCs
- Annun/Alerts
- Appendix
- Index

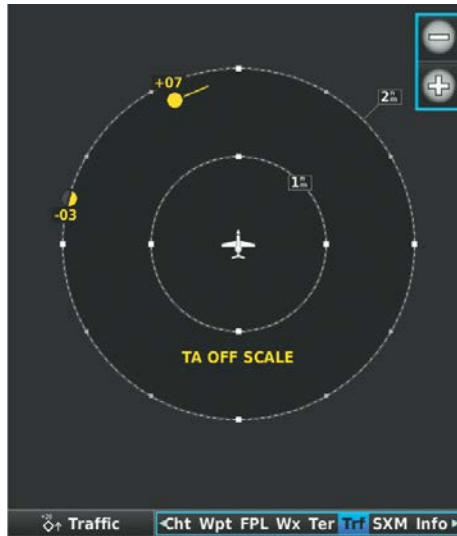

Traffic Page

GARMIN GTS 8XX TRAFFIC (OPTIONAL)



WARNING: Do not rely solely upon the display of traffic information for traffic avoidance maneuvering. The GTS 8XX Traffic Advisory System (TAS) and Traffic Collision Avoidance System (TCAS I) is intended for advisory use only to aid the pilot in visually acquiring traffic. No avoidance maneuvers should be based solely upon TAS/TCAS I traffic information. It is the responsibility of the pilot in command to see and maneuver to avoid traffic.



NOTE: Pilots should be aware of TAS/TCAS I system limitations. TAS/TCAS I systems require transponders of other aircraft to respond to system interrogations. If the transponders do not respond to interrogations due to phenomena such as antenna shading or marginal transponder performance, traffic may be displayed intermittently, or not at all. Aircraft without altitude reporting capability are shown without altitude separation data or climb descent indication. Pilots should remain vigilant for traffic at all times.



NOTE: TIS-A is disabled when TAS/TCAS I installed.

The optional Garmin GTS 8XX is a Traffic Advisory System (TAS) and Traffic Collision Avoidance System (TCAS I). It enhances flight crew situational awareness by displaying traffic information for transponder-equipped aircraft. The system also provides visual and aural traffic alerts including voice announcements to assist in visually acquiring traffic.

The GTS 8XX is capable of tracking up to 45 intruding aircraft equipped with Mode A or C transponders, and up to 30 intruding aircraft equipped with Mode S transponders. A maximum of 30 aircraft with the highest threat potential can be displayed simultaneously. No TAS/TCAS I surveillance is provided for aircraft without operating transponders.

THEORY OF OPERATION





When the GTS 8XX is in Operating Mode, the unit interrogates the transponders of intruding aircraft while monitoring transponder replies. The system uses this information to derive the distance, relative bearing, and if reported, the altitude and vertical trend for each aircraft within its surveillance range. The GTS 8XX then calculates a closure rate to each intruder based on the projected Closest Point of Approach (CPA). If the closure rate meets the threat criteria for a Traffic Advisory (TA), visual and aural alerting is provided.

TAS/TCAS I SURVEILLANCE VOLUME

The GTS 8XX surveillance system monitors the airspace within $\pm 10,000$ feet of own altitude. Under ideal conditions, the GTS 8XX unit scans transponder traffic up to 12 nm in the forward direction. The range is somewhat reduced to the sides and aft of own aircraft due to the directional interrogation signal patterns. In areas of greater transponder traffic density or when TCAS II (Traffic Alert and Collision Avoidance System II) systems are detected, the GTS 8XX automatically reduces its interrogation transmitter power (and therefore range) in order to limit potential interference from other signals.

TAS/TCAS I SYMBOLOGY

The GTS 8XX uses symbology to depict intruding traffic using the symbols shown below.

Symbol	Description
	Traffic Advisory.
	Traffic Advisory out of the selected display range. Displayed at outer range ring at proper bearing.
	Proximity Advisory.
	Non-Threat Traffic.

GTS 8XX Traffic Symbols

A Traffic Advisory (TA), displayed as a yellow circle or triangle, alerts the crew to a potentially hazardous intruding aircraft, if the closing rate, distance, and vertical separation meet TA criteria. A Traffic Advisory that is beyond the selected display range (off scale) is indicated by a half TA symbol at the edge of the screen at the relative bearing of the intruder.

A Proximity Advisory (PA), displayed as a solid white diamond or triangle, indicates the intruding aircraft is within ± 1200 feet and is within a 6 nm range, but is still not considered a TA threat.

A Non-threat Advisory, shown as an open white diamond or triangle, is displayed for traffic beyond 6 nm that is neither a TA or PA.

Relative altitude, when available, is displayed above or below the corresponding intruder symbol in hundreds of feet. When this altitude is above own aircraft, it is preceded by a '+' symbol; a minus sign '-' indicates traffic is below own aircraft.

A vertical trend arrow to the right of the intruder symbol indicates climbing or descending traffic with an upward or downward-pointing arrow respectively.

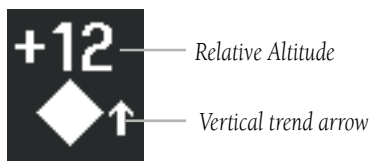

Intruder Altitude and Vertical Trend Arrow

Flight IDs may also be displayed with traffic symbols; see the Flight IDs discussion in this section for more information.

TAS/TCAS I ALERTS

When the GTS 8XX detects a new TA, the following occur:

- A single "Traffic!" voice alert is generated, followed by additional voice information about the bearing, relative altitude, and approximate distance from the intruder that triggered the TA. The announcement "Traffic! 12 o'clock, high, four miles," would indicate the traffic is in front of own aircraft, above own altitude, and approximately four nautical miles away.
- A TRAFFIC Annunciation appears at the top right of the airspeed on the PFD, flashing for five seconds and remains displayed until no TAs are detected in the area.

If the bearing of TA traffic cannot be determined, a yellow text banner will be displayed in the center of the Traffic Page and in the lower-left of the PFD inset map (GDU 460 only) instead of a TA symbol. The text will indicate "TA" followed by the distance, relative altitude, and vertical trend arrow for the TA traffic, if known.

Bearing	Relative Altitude	Distance (nm)
"One o'clock" through "Twelve o'clock" or "No Bearing"	"High", "Low", "Same Altitude" (if within 200 feet of own altitude), or "Altitude not available"	"Less than one mile", "One Mile" through "Ten Miles", or "More than ten miles"

TA Descriptive Voice Announcements

TA ALERTING CONDITIONS

The GTS 8XX automatically adjusts its TA sensitivity level to reduce the likelihood of nuisance TA alerting during flight phases likely to be near airports. The system uses Level A TA sensitivity when the groundspeed is less than 120 knots; Level B TA sensitivity applies in all other conditions.

Sensitivity Level	Intruder Altitude Available	TA Alerting Conditions
A	Yes	Intruder closing rate provides less than 20 seconds of vertical and horizontal separation. Or: Intruder closing rate provides less than 20 seconds of horizontal separation and vertical separation is within 600 feet. Or: Intruder range is within 0.2 nm and vertical separation is within 600 feet.
A	No	Intruder closing rate provides less than 15 seconds of separation or intruder range is within 0.2 NM.
B	No	Intruder closing rate provides less than 20 seconds of separation or intruder range is within 0.55 NM.
B	Yes	Intruder closing rate provides less than 30 seconds of vertical and horizontal separation. Or: Intruder closing rate provides less than 30 seconds of horizontal separation and vertical separation is within 800 feet. Or: Intruder range is within 0.55 nm and vertical separation is within 800 feet.

TA Sensitivity Level and TA Alerting Criteria

- System Overview
- Flight Instruments
- EIS
- CNS Interface
- GPS Navigation
- Flight Planning
- Hazard Avoidance
- Additional Features
- AFCs
- Annun/Alerts
- Appendix
- Index

SYSTEM TEST



NOTE: *Traffic surveillance is not available during the system test. Use caution when performing a system test during flight.*

The GTS 8XX provides a system test mode to verify the TAS/TCAS I system is operating normally. The test takes ten seconds to complete. When the system test is initiated, a test pattern of traffic symbols is displayed on the Traffic Page. If the system test passes, the aural announcement "TAS/TCAS 1 System Test Passed" is heard, otherwise the system announces "TAS/TCAS 1 System Test Failed." When the system test is complete, the traffic system enters Standby Mode.

- 1) From the Traffic Page, touch **+** or **-** to set the range to 2/6 nm to allow the full test pattern to be displayed during test.
- 2) Press the **MENU** Key.
- 3) Touch **Self-test**.

OPERATION



NOTE: *The GTS 8XX automatically transitions from **Standby** to **Operate** mode eight seconds after takeoff. The unit also automatically transitions from **Operate** to **Standby** mode 24 seconds after landing.*

After starting the system, the GTS 8XX is in Standby Mode. The GTS 8XX must be in Operating Mode for traffic to be displayed and for TAs to be issued.

Touching **Operate** on the Traffic Page Options Menu, allows the traffic unit to switch from Standby Mode to Operating Mode as necessary. Touching **Standby**, forces the unit into Standby Mode.

Switching from operating mode to standby mode:

- 1) From the Traffic Page, press the **MENU** Key.
- 2) Touch **Standby**.

Switching from standby mode to operating mode:

- 1) From the Traffic Page, press the **MENU** Key.
- 2) Touch **Operate**.

Changing the altitude range:

- 1) From the Traffic Page, press the **MENU** Key.
- 2) Touch **Alt Mode**.
- 3) Touch one of the following:
 - **Above:** Displays non-threat and proximity traffic from 9000 feet above the aircraft to 2700 feet below the aircraft. Typically used during climb phase of flight.
 - **Normal:** Displays non-threat and proximity traffic from 2700 feet above the aircraft to 2700 feet below the aircraft. Typically used during enroute phase of flight.
 - **Below:** Displays non-threat and proximity traffic from 2700 feet above the aircraft to 9000 feet below the aircraft. Typically used during descent phase of flight.
 - **Unrestricted:** All traffic is displayed from 9900 feet above and 9900 feet below the aircraft.

FLIGHT ID DISPLAY

The Flight IDs of other aircraft (when available) can be enabled for display on the Traffic Page. When a flight ID is received, it will appear above or below the corresponding traffic symbol on the Traffic Page when this option is enabled.

Enabling/disabling Flight ID Display:

- 1) From the Traffic (Trf) Page, press the **MENU** Key.
- 2) Touch **Flight ID** to toggle the Flight ID on and off.

TRAFFIC PAGE

The Traffic Page shows surrounding TAS/TCAS I traffic data in relation to the aircraft's current position and altitude, without basemap clutter. It is the primary page for viewing traffic information. Aircraft orientation is always heading up unless there is no valid heading. Map range is adjustable by touching **+** and **-**, as indicated by the map range rings.

The traffic mode and altitude display mode are annunciated in the upper left corner of the page.

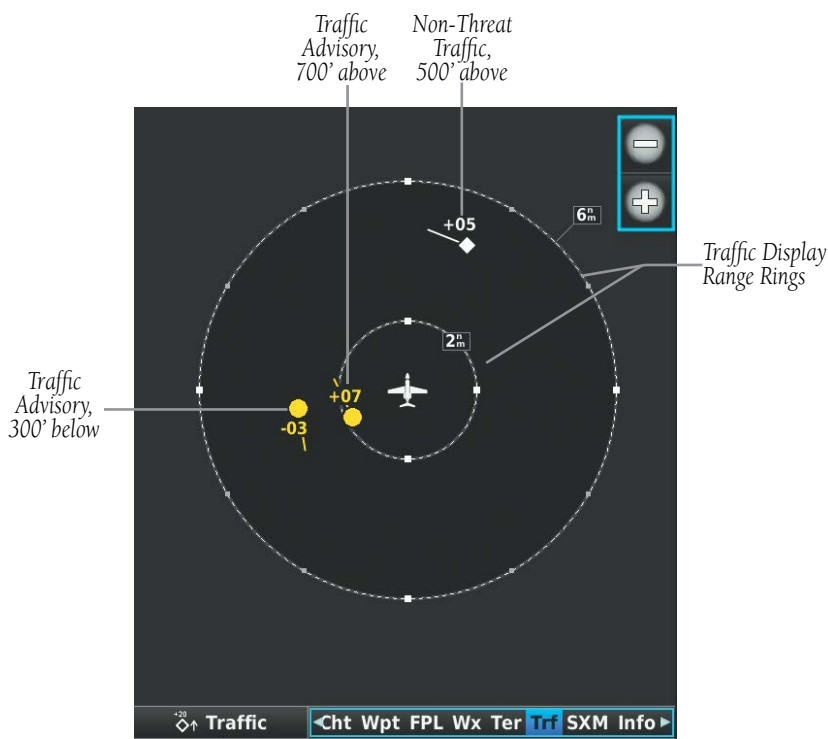

Traffic Page (GTS 8XX)

DATA LINK TRAFFIC (OPTIONAL)

The ADS-B receiver is a receive-only data link radio with on-board GPS, 978 MHz (Universal Access Transceiver frequency band), and 1090 MHz Extended Squitter (1090 ES) receivers. It is designed to receive, process, and output traffic (ADS-B air-to-air, and TIS-B traffic information), and weather (Flight Information Service-Broadcast (FIS-B)) information to the G3X Touch system through an RS-232 serial connection or Bluetooth connection.

ADS-B (Automatic Dependent Surveillance-Broadcast) is a surveillance technology deployed across the United States as the cornerstone of the FAA's Next Generation Air Transportation System (NextGen). ADS-B enables improved surveillance services, both air-to-air and air-to-ground, especially in areas where radar is ineffective due to terrain or where it is impractical or cost prohibitive. Initial applications of air-to-air ADS-B are for "advisory" use only, enhancing a pilot's visual acquisition of other nearby ADS-B equipped aircraft either when airborne or on the airport surface.

System Overview

Flight Instruments

EIS

CNS Interface

GPS Navigation

Flight Planning

Hazard Avoidance

Additional Features

AFCs

Annun/Alerts

Appendix

Index

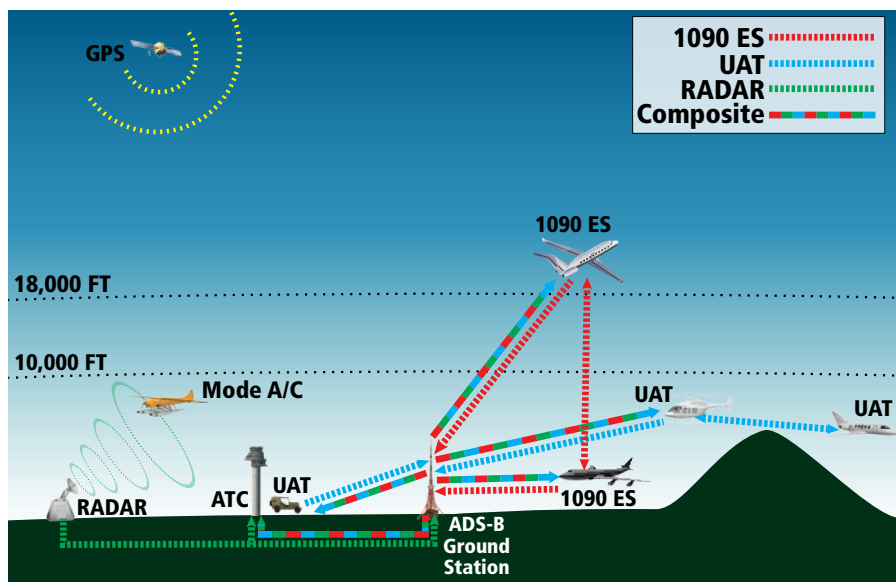

ADS-B System

For the purpose of distinguishing between levels of ADS-B service, there are three classifications of aircraft or system capability; ADS-B In, ADS-B Out, and ADS-B participating. ADS-B In refers to the capability to receive ADS-B information. ADS-B Out refers to the capability to transmit ADS-B information. ADS-B participating refers to the capability to both send and receive ADS-B information. Aircraft lacking either ADS-In, ADS-B Out, or both ADS-B capabilities may also be referred to as ADS-B non-participating aircraft.

Currently, rule-compliant ADS-B Out capability in the United States requires a TSO'ed SBAS-enabled GPS, such as a Garmin GPS 400W or similar, and one of two possible data links: 1090 ES transponder or a 978 MHz UAT. Either data link system is capable of transmitting the aircraft's position, velocity, identification, and other information every second to compatible aircraft and ground stations called Ground Based Transceivers (GBTs).

Because 1090 ES transponders and UATs operate on different frequencies, aircraft not similarly equipped cannot transmit/receive data link information directly to/from each other. Instead, operation within range of a GBT is required to receive data link information on both frequencies. The ADS-B receiver is unique in its ADS-B In capability since it can receive data link information from both 1090 ES transponders and UATs.

Thus, the ADS-B receiver receives traffic information directly from any ADS-B Out aircraft within range as well as the rebroadcast of ADS-B information from any nearby GBT. This rebroadcast is called Automatic Dependent Surveillance-Rebroadcast (ADS-R) and is automatically triggered by the detection of an ADS-B participating aircraft within the service volume of the GBT. As a 978 MHz (UAT frequency) receiver, the ADS-B receiver can receive both the Traffic Information Service-Broadcast (TIS-B) and Flight Information Service-Broadcast (FIS-B) provided in conjunction with ADS-R services when in range of a GBT.

FIS-B service is provided continuously, but ADS-R including TIS-B will only be broadcast by a GBT when an ADS-B participating aircraft is within the GBT's defined service volume. In this case, a GBT will only rebroadcast TIS-B information relative to the ADS-B participating aircraft. **Only traffic that is within 15 nm lateral and 3,500' vertical of the ADS-B participating aircraft is provided in the broadcast.** Non-participating traffic aircraft located farther than 15 nm laterally and 3,500' vertically from the participating aircraft is excluded from the information transmitted by the GBT.

TIS-B traffic information includes non-participating aircraft detected by ATC surveillance radar. As TIS-B data is derived from ATC surveillance radar data, TIS-B traffic position updates typically occur every three to thirteen seconds. **Therefore, TIS-B traffic may be displayed with degraded positional accuracy. Aircraft without operating transponders are invisible to TIS-B. Aircraft operating outside of the ATC radar coverage area are also not displayed.**

Since the ADS-B receiver is a receive-only device, even when used onboard an aircraft equipped with a qualifying GPS and 1090 ES transponder, a GBT may not identify it as an ADS-B participating aircraft. The squitter of some 1090 ES transponders must be configured to communicate the aircraft has 978 MHz receive capability in order to be identified as an ADS-B participating aircraft.



WARNING: Do not rely solely upon the display of traffic information for collision avoidance maneuvering. The traffic display does not provide collision avoidance resolution advisories and does not, under any circumstances or conditions, relieve the pilot's responsibility to see and avoid other aircraft.



WARNING: Do not rely solely upon the display of traffic information to accurately depict all of the traffic within range of the aircraft. Due to lack of equipment, poor signal reception, and/or inaccurate information from aircraft or ground stations, traffic may be present that is not represented on the display.

Viewing the ADS-B Receiver Traffic and Weather Status:

- 1) Press the **MENU** Key twice.
- 2) Touch **Data Link**.

SYSTEM STATUS













The traffic system status is annunciated in the upper right corner of the Map Page as well as the lower left corner of the dedicated Traffic Page.

Traffic Icon	System Status
	Full traffic services available for an ADS-B participating aircraft (ground linked TIS-B, FIS-B and ADS-R, and Air-to-Air ADS-B). If you are using the ADS-B receiver on a non-participating aircraft you may still see this when you are within the service area of any participating aircraft. As a non-participating aircraft you are only receiving TIS-B traffic information for traffic within 15 nm and 3,500' of a participating aircraft.
	Limited traffic services available (may be limited to Air-to-Air ADS-B)
	No Traffic Data Available

Traffic Modes

TRAFFIC DESCRIPTION

ADS-B traffic operation is similar to the TAS/TCAS I systems discussed previously, but ADS-B adds additional symbology. The symbols used to display ADS-B traffic are shown in the table below. The traffic identifier and altitude are displayed below the traffic symbol. A small up or down arrow next to the traffic symbol indicates the traffic is climbing or descending at a rate of at least 500 feet per minute. The vector line that extends from the traffic symbol is an indication of the intruder aircraft track. For directional traffic symbols, the arrow head points in the direction of aircraft's ground track.



Symbol	Description
	Non-threat, non-directional airborne traffic
	Non-threat directional airborne Traffic with absolute vector. Points in the direction of the aircraft track.
	Non-directional airborne Proximity Advisory (PA). Proximity Advisories are issued for any traffic within 6 nautical miles and +/- 1,200'.
	Directional airborne Proximity Advisory (PA) with absolute vector. Points in the direction of the aircraft track. Proximity Advisories are issued for any traffic within 6 nautical miles and +/- 1,200'.
	Non-directional airborne Traffic Advisory (TA)
	Non-directional off-scale airborne Traffic Advisory (TA). Displayed at outer range ring at proper bearing.
	Directional airborne Traffic Advisory (TA) with absolute vector. Points in the direction of the aircraft track.
	Directional off-scale airborne Traffic Advisory (TA). Points in the direction of the aircraft track.
	*Ground traffic without directional information. Ground traffic is only displayed when own aircraft is below 1,500 feet AGL or on the ground.
	*Directional surface traffic. Ground traffic is only displayed when own aircraft is below 1,500 feet AGL or on the ground.
	*Non-directional non-aircraft ground traffic. Ground traffic is only displayed when own aircraft is below 1,500 feet AGL or on the ground.
	*Directional non-aircraft ground traffic. Ground traffic is only displayed when own aircraft is below 1,500 feet AGL or on the ground.
*Ground traffic is only displayed on the Map Page when the aircraft is on the ground or below 1,500 feet AGL. Ground traffic is always displayed on the dedicated traffic page.	

ADS-B Traffic Symbology

TRAFFIC ADVISORIES (TA)

ADS-B traffic devices automatically adjust the Traffic Advisory (TA) sensitivity level to reduce the likelihood of nuisance TA alerts during various phases of flight. TAs are issued for traffic when they are predicted to be within a specified volume of airspace around your aircraft in a specified amount of time. The protected volume and time interval varies based on the current geodetic altitude and groundspeed. Thus, the protected volume of airspace increases with altitude and ground speed. Refer to the following table for details.

The following Traffic symbols are displayed on the display when Synthetic Vision is installed and enabled. See the Additional Features Section for more information about Synthetic Vision.

ADS-B Symbol on the PFD (Synthetic Vision Only)	Description
	Proximity Advisory (PA)
	Traffic Advisory (TA)
	Non-threat traffic

PFD ADS-B Symbology (Synthetic Vision Only)

TRAFFIC ALERTS (ADS-B TIS-B)

A traffic voice alert is generated whenever the number of Traffic Advisories on the G3X Touch display increases. Limiting Traffic Advisories only reduces the “nuisance” alerting due to proximate aircraft. For example, when the first Traffic Advisories appear on the display, the user is alerted audibly. So long as a single aircraft remains on the display, no further voice alert is generated. If a second (or more) aircraft appears on the screen, a new voice alert is sounded. Traffic Advisories can only be issued when the GDL knows its own altitude and the altitude of the intruder aircraft.

If the number of Traffic Advisories on the traffic display decreases and then increases, a new voice alert is sounded. The traffic voice alert is also generated whenever TIS-B service becomes available. The traffic voice alerts are as follows:

- “Traffic”—TIS-B/ADS-B traffic alert received.
- “Traffic Not Available”—TIS-B/ADS-B service is not available or out of range.

Enabling/disabling the traffic alerts:



NOTE: Traffic alerts are reset to ‘enabled’ on the next power cycle.

- 1) From the Traffic Page, press the **MENU** Key.
- 2) Touch **Alerts** to toggle between **Enabled** and **Inhibited**.

TRAFFIC WARNING WINDOW

The Traffic Warning Window is shown, when the ADS-B receiver issues a traffic advisory (TA). The Traffic Warning Window shows a small pop-up map in the lower left corner. The Range Rings on the pop-up alert are spaced every whole mile/kilometer/nautical mile.

DISPLAYING TRAFFIC DATA

Traffic is displayed by default on the Map Page and in the Traffic Warning Window. Traffic Symbol and Traffic Label (i.e., relative altitude, altitude trend and absolute motion vectors) settings selects the maximum range at which traffic labels or symbols are shown. Traffic Labels can also be turned off.

Traffic information is also displayed on the PFD when Synthetic Vision is enabled. See the ‘Additional Features’ Section for more information.

Enabling/disabling traffic data on the Map Page:

- 1) From the Map Page, press the **MENU** Key.
- 2) Touch **Traffic**.

Customizing traffic data on the Map Page:

- 1) From the Map Page, press the **MENU** Key.
- 2) Touch **Set Up Map**.

- 3) Touch and swipe the tabs to find the **Traffic** Tab.
- 4) Touch the **Traffic** Tab.
- 5) Touch the **Traffic Data** to view a list of options.
- 6) Touch **On** or **Off**.
- 7) Touch the **Traffic Symbol** to view a list of options.
- 8) Touch **Auto** or a range option.
- 9) Touch the **Traffic Label** to view a list of options.
- 10) Touch **Off**, **Auto**, or a range.
- 11) Touch the **Traffic Identifier** to view a list of options.
- 12) Touch **Off**, **Auto**, or a range.

Enabling/disabling traffic on the Synthetic Vision display:

- 1) Touch the HSI or Attitude Indicator on the PFD.
- 2) Touch **More Options**.
- 3) Touch **Traffic** to toggle traffic on and off.

Displaying Traffic information:

Touch the traffic on the map to display range and altitude separation information.



Traffic (Map Page)

- System Overview
- Flight Instruments
- EIS
- CNS Interface
- GPS Navigation
- Flight Planning
- Hazard Avoidance
- Additional Features
- AFCs
- Annun/Alerts
- Appendix
- Index

DEDICATED TRAFFIC PAGE (TRF)



NOTE: Traffic alerts and altitude filters can only be changed on the dedicated Traffic Page (Trf). If the Traffic Page (Trf) is configured off, voice alerts are enabled and the altitude filter is automatically set to 'Normal'

Displaying/removing the Traffic Page:

- 1) From the Traffic Page, press the **MENU** Key.
- 2) Touch the **Traffic Page** .
- 3) Touch **Show** or **Hide**.

Changing the altitude range:

- 1) From the Traffic Page, press the **MENU** Key.
- 2) Touch **Alt Mode**.
- 3) Touch one of the following:
 - **Above:** Displays non-threat and proximity traffic from 9,000 feet above the aircraft to 2,700 feet below the aircraft. Typically used during climb phase of flight.
 - **Normal:** Displays non-threat and proximity traffic from 2,700 feet above the aircraft to 2,700 feet below the aircraft. Typically used during enroute phase of flight.
 - **Below:** Displays non-threat and proximity traffic from 2,700 feet above the aircraft to 9,000 feet below the aircraft. Typically used during descent phase of flight.
 - **Unrestricted:** All traffic is displayed.

- System Overview
- Flight Instruments
- EIS
- CNS Interface
- GPS Navigation
- Flight Planning
- Hazard Avoidance
- Additional Features
- AFCS
- Annun/Alerts
- Appendix
- Index

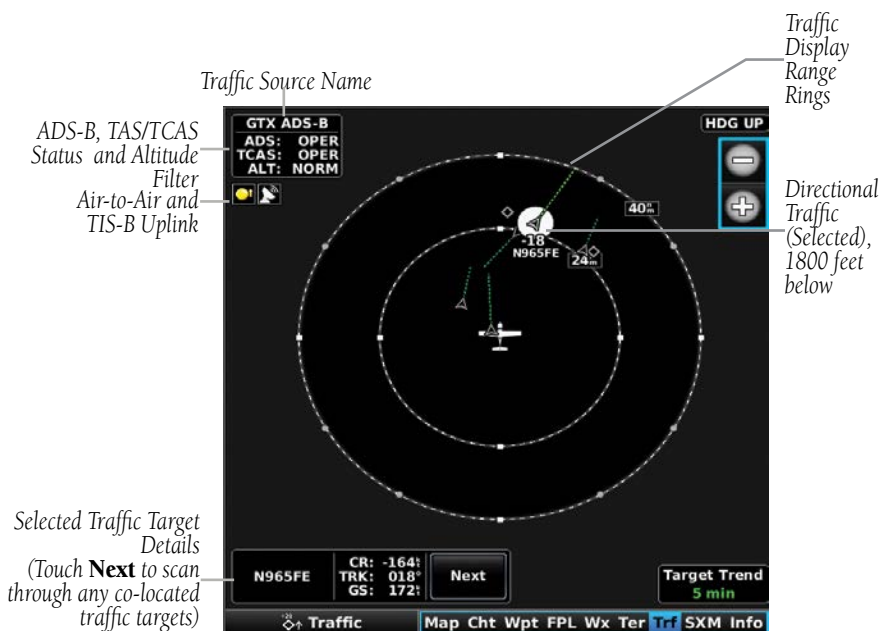

Traffic Page (Traffic Target Selected)

When a traffic target is selected, a decluttering scheme is applied to direct the pilot's attention to the selected target. Traffic targets not selected (except active TAs) temporarily display decluttered symbology.

FLIGHT ID DISPLAY

The Flight IDs of other aircraft (when available) can be displayed on the Traffic Page. When a Flight ID or call sign is received, it will appear below the corresponding traffic symbol when enabled.



Example ADS-B Traffic Symbol

Enabling/disabling Flight ID Display:

- 1) From the Traffic Page, press the **MENU** Key.
- 2) Touch the **Flight ID**.

MOTION VECTORS

There are two pilot-selectable and mutually exclusive types of motion vectors, Absolute and TargetTrend, which are differentiated by color and function. Absolute vectors are white and indicate ground track as reported by the traffic. TargetTrend vectors are green and indicate the flight path and position, relative to your aircraft, at which the traffic will be after the passing of one of four predetermined look-ahead intervals. The end of the TargetTrend vector indicates the traffic's predicted location relative to your predicted location at the end of the look-ahead time. For example, if traffic is ahead of you and traveling along the same track but at a slower rate, the motion vector would point opposite of its indicated direction of flight showing that you are overtaking the traffic.

The TargetTrend look-ahead time interval is automatically adjusted from 30 seconds to five minutes and corresponds to the traffic display range setting. The greater the range setting, the longer the time interval and vice versa. Refer to the table below for more details.

Traffic Page Range Ring Settings	TargetTrend Look-ahead
.5nm to 2nm	30 seconds
2nm to 6nm	60 seconds
6nm to 12nm	2 minutes
12nm to 40nm	5 minutes

TargetTrend Look-ahead

Motion vector selection is made from the Traffic Page Menu by enabling/disabling TargetTrend. Absolute vectors are selected by default and are replaced when TargetTrend is enabled.

Enabling/disabling TargetTrend:

- 1) From the Traffic Page, press the **MENU** Key.
- 2) Touch the **TargetTrend**.

TARGETTREND ON MAP

In addition to the Traffic Page, the Map Page can show TargetTrend vectors of nearby traffic. These indications are overlaid on top of regular topographic maps and VFR/IFR charts, showing how nearby traffic relates to surrounding waypoints, airspaces and ground features.



TargetTrend Overlaid on Moving Map

Enabling/disabling TargetTrend Overlay:

- 1) With the Map Page displayed, press the **MENU** Key.
- 2) Touch **Set Up Map**.
- 3) Under the 'Traffic' Tab, touch and drag to scroll to the **TargetTrend** field.
- 4) Touch **On** or **Off**.

- System Overview
- Flight Instruments
- EIS
- CNS Interface
- GPS Navigation
- Flight Planning
- Hazard Avoidance
- Additional Features
- AFCs
- Annun/Alerts
- Appendix
- Index

SECTION 8 ADDITIONAL FEATURES



NOTE: With the availability of SafeTaxi, FliteCharts, and ChartView in electronic form, it is still advisable to carry another source of charts on board the aircraft.

Additional features of the system include the following:

- Synthetic Vision (SVX)
- SafeTaxi®
- ChartView and FliteCharts® electronic charts
- Airport Directory Data (AOPA , AC-U-KWIK, etc.)
- SiriusXM Radio entertainment (Optional)
- Electronic Checklists (Optional)
- Flight Data Logging

Synthetic Vision provides a three-dimensional forward view of terrain features on the PFD. Synthetic Vision imagery shows the pilot's view of relevant features in relation to the aircraft attitude, as well as the flight path pertaining to the active flight plan.

SafeTaxi diagrams provide detailed taxiway, runway, and ramp information.

ChartView and FlightCharts provide on-board electronic terminal procedure charts. Electronic charts offer the convenience of rapid access to essential information. Either ChartView or FliteCharts may be used at one time, but not both.

The Airport Directory contains airport statistics such as pattern altitudes, noise abatement information, FBO phone numbers, hours of operation, local attractions, ground transportation, lodging, and services.

The optional SiriusXM Radio entertainment audio feature offers more than 170 channels of music, news, and sports.

Optional checklists help to quickly find the proper procedure on the ground or during flight.

The Flight Data Logging feature automatically stores critical flight and engine data on an SD data card. A 2 GB SD card can store over 1,000 hours of flight data or up to 1,000 files (whichever comes first).

8.1 SYNTHETIC VISION (SVX)



WARNING: Use appropriate primary systems for navigation, and for terrain, obstacle, and traffic avoidance. Synthetic Vision is intended as an aid to situational awareness only and may not provide either the accuracy or reliability upon which to solely base decisions and/or plan maneuvers to avoid terrain, obstacles, or traffic.

Synthetic Vision is a visual enhancement to the G3X Touch™. Synthetic Vision depicts a forward-looking attitude display of the topography immediately in front of the aircraft. Synthetic Vision information is shown on the Primary Flight Display (PFD). The depicted imagery is derived from the aircraft attitude, heading, GPS three-dimensional position, and databases of terrain, obstacles, and other relevant features. Loss of any of the required data, including temporary loss of the GPS signal, will cause Synthetic Vision to be disabled until the required data is restored.

The Synthetic Vision terrain display shows land contours (colors are consistent with those of the topographical map display), large water features, towers, and other obstacles over 200' AGL that are included in the obstacle database. Cultural features on the ground such as roads, highways, railroad tracks, cities, and state boundaries are not displayed even if those features are found on the Navigation Map. The terrain display also includes a north-south east-west grid with lines oriented with true north.

Terrain is integrated within Synthetic Vision to provide visual and auditory alerts to indicate the presence of terrain and obstacle threats relevant to the projected flight path. Terrain alerts are displayed in red and yellow shading on the PFD.

The terrain display is intended for situational awareness only. It may not provide the accuracy or fidelity on which to base decisions and plan maneuvers to avoid terrain or obstacles. Navigation must not be predicated solely upon the use of the terrain or obstacle data displayed by Synthetic Vision.

The following Synthetic Vision enhancements appear on the PFD:

- Pathways
- Flight Path Marker
- Traffic Display
- Airport Signs
- Runway Display
- Terrain Alerting
- Obstacle Alerting
- Zero-Pitch Line

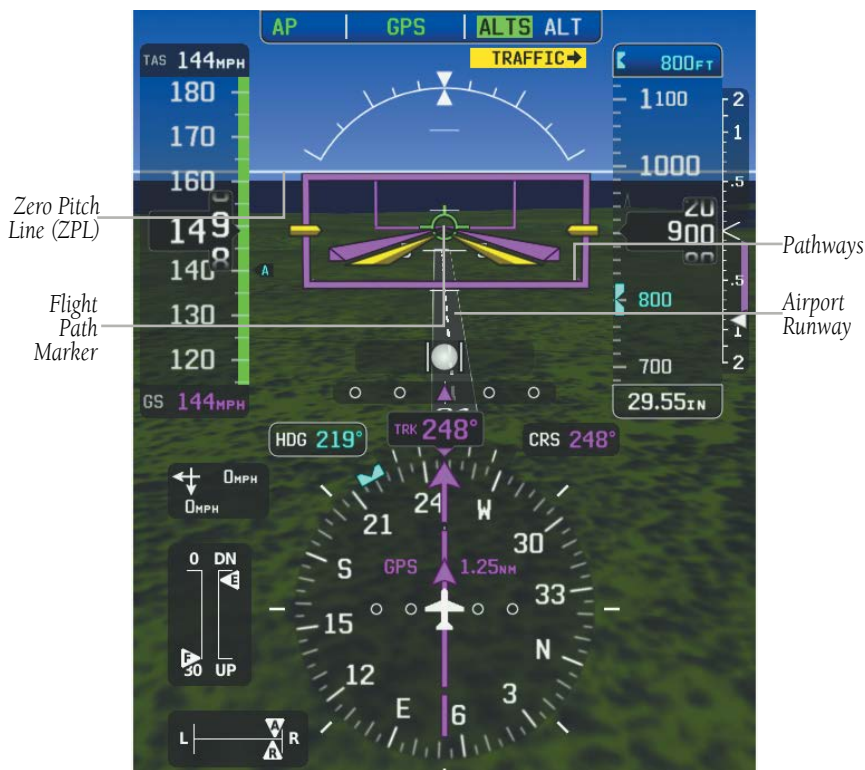

Synthetic Vision

SYNTHETIC VISION OPERATION

Synthetic Vision is activated from the PFD Setup Page.

Activating and deactivating synthetic vision:

- 1) Touch the Attitude Indicator or HSI to display the PFD Options.
- 2) Touch **More Options**.
- 3) Touch and drag to scroll down.
- 4) Touch **Synthetic Vision** to toggle on and off.

PATHWAYS



NOTE: Pathways and terrain features are not a substitute for standard course and altitude deviation information provided by the CDI, VSI, and VDI.



NOTE: Pathways boxes may not be displayed for holding patterns, procedure turns and certain portions of the flight plan being received from an external GPS navigator.

Pathways provide a three-dimensional perspective view of the selected route of flight shown as colored rectangular boxes representing the horizontal and vertical flight path of the active flight plan. The box size represents 700 feet wide by 200 feet tall during enroute, oceanic, and terminal flight phases. During an approach, the box width is 700 feet or one half full scale deviation on the HSI, whichever is less. Other than the descending portion of an ILS or WAAS GPS approach (starting from the leg leading into the FAF), pathways boxes are shown at the level of the altitude bug.

The color of the rectangular boxes may be magenta, green, or white depending on the route of flight and navigation source selected. The active GPS or GPS overlay flight plan leg is represented by magenta boxes that correspond to the Magenta CDI. A localizer course is represented by green boxes that correspond to a green CDI. An inactive leg of an active flight plan is represented by white boxes corresponding to a white line drawn on the Navigation Map indicating an inactive leg.

Pathways provide supplemental glidepath information on an active ILS, LPV, LNAV/VNAV, and some LNAV approaches. Pathways are intended as an aid to situational awareness and should not be used independent of the CDI, VDI, glide path indicator, and glide slope indicator. They are removed from the display when the selected navigation information is not available. Pathways are not displayed beyond the active leg when leg sequencing is suspended and are not displayed on any portion of the flight plan leg that would lead to intercepting a leg in the wrong direction.

Activating and deactivating pathways:

- 1) Touch the Attitude Indicator or HSI to display the PFD Options.
- 2) Touch **More Options...**
- 3) Touch and drag to scroll down.
- 4) Touch **Pathways** to toggle on and off.

DEPARTURE AND ENROUTE

Prior to intercepting an active flight plan leg, pathways are displayed as a series of boxes with pointers at each corner that point in the direction of the active waypoint. Pathways are not displayed for the first leg of the flight plan if that segment is a Heading-to-Altitude leg. The first segment displaying pathways is the first active GPS leg or active leg with a GPS overlay. If this leg of the flight plan route is outside the SVX field of view, pathways will not be visible until the aircraft has turned toward this leg. While approaching the center of the active leg and prescribed altitude, the number of pathway boxes decreases to a minimum of four.

Pathways are displayed along the flight plan route at the selected altitude for the leg. Climb profiles cannot be displayed due to the variables associated with aircraft performance. Flight plan legs requiring a climb are indicated by pathways displayed at a level above the aircraft at the altitude selected.

DESCENT AND APPROACH



NOTE: During the final segment of an ILS or WAAS GPS approach, the pathways boxes automatically adjust to correspond with the localizer/glideslope (ILS) or horizontal/vertical (GPS) deviation signals received from the external navigator.

When an approach providing vertical guidance is activated, Pathways are shown level at the selected altitude. Pathways are shown level at the selected altitude up to the point along the final approach course where the altitude intercepts the extended vertical descent path or glideslope. From the vertical path descent or glideslope intercept point, the pathways are shown inbound to the Missed Approach Point (MAP) along the published lateral and vertical descent path.

During an ILS approach, the initial approach segment is displayed in magenta at the segment altitudes if GPS is selected as the navigation source on the CDI. When switching to the localizer inbound with LOC selected as the navigation source on the CDI, pathways are displayed in green along the localizer and glideslope.

If GPS is the selected navigation source on the HSI, the pathways boxes are magenta. If LOC is the selected navigation source on the HSI, the pathways boxes are green for the ILS. Pathways boxes are not displayed for segments such as heading legs or VOR radials.

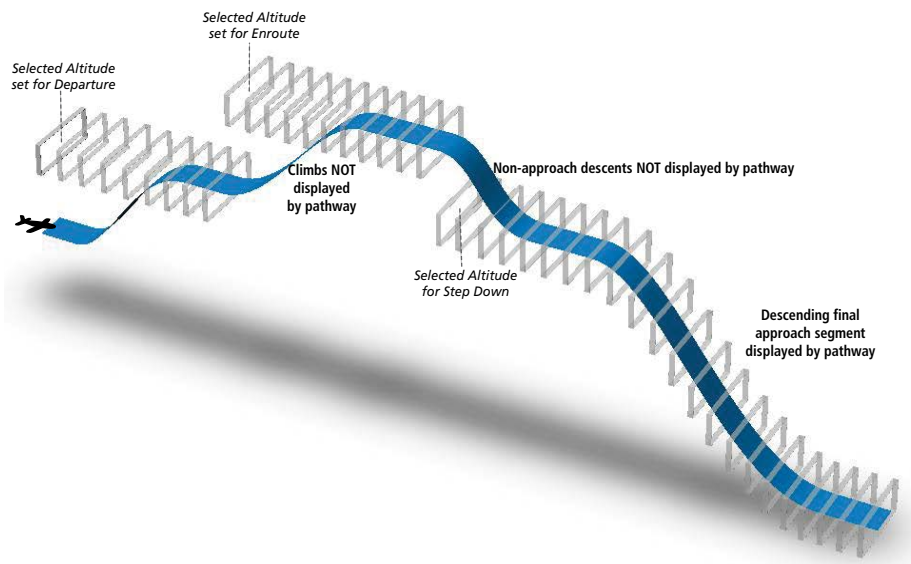

Pathways - Enroute, Descent, and Approach

MISSED APPROACH

Pathways are displayed at the selected altitude upon activating the missed approach on the external GPS navigator.

FLIGHT PATH MARKER

The Flight Path Marker (FPM), also known as a Velocity Vector, is displayed on the PFD at groundspeeds above 30 knots. The FPM depicts the approximate projected path of the aircraft accounting for wind speed and direction relative to the three-dimensional terrain display.

The FPM is always available when the Synthetic Vision feature is in operation. The FPM represents the direction of the flight path as it relates to the terrain and obstacles on the display, while the airplane symbol represents the aircraft heading and attitude.

The FPM may be used to identify a possible conflict with the aircraft flight path and distant terrain or obstacles. Displayed terrain or obstacles in the aircraft's flight path extending above the FPM could indicate a potential conflict, even before a terrain alert is issued. However, decisions regarding terrain and/or obstacle avoidance should not be made using only the FPM.

Activating and deactivating the flight path marker:

- 1) Touch the Attitude Indicator or HSI to display the PFD Options.
- 2) Touch **More Options**.
- 3) Touch and drag to scroll down.
- 4) Touch **Flt. Path Marker** to toggle the flight path marker on and off.

ZERO PITCH LINE

The Zero Pitch Line is drawn completely across the display and represents the aircraft attitude with respect to the horizon. It may not align with the terrain horizon, particularly when the terrain is mountainous or when the aircraft is flown at high altitudes.

TRAFFIC



WARNING: Intruder aircraft at or below 500 ft. AGL may not appear on the Synthetic Vision display or may appear as a partial symbol.

Traffic symbols are displayed in their approximate locations. Traffic symbols are displayed in three dimensions, appearing larger as they are getting closer, and smaller when they are further away. Traffic within 250 feet laterally of the aircraft will not be displayed on the Synthetic Vision display. Traffic symbols and coloring are consistent with that used for traffic displayed on the Inset Map or Map Page. If the traffic altitude is unknown, the traffic will not be displayed on the Synthetic Vision display. For more details refer to the Traffic Information Service (TIS-A) discussion in the Hazard Avoidance section. Arrows are depicted on the traffic message if traffic is outside the Synthetic Vision field of view.

Enabling/disabling traffic on the Synthetic Vision display:

- 1) Touch the Attitude Indicator or HSI to display the PFD Options.
- 2) Touch **More Options**.
- 3) Touch and drag to scroll down.
- 4) Touch **Traffic** to toggle synthetic vision traffic on and off.

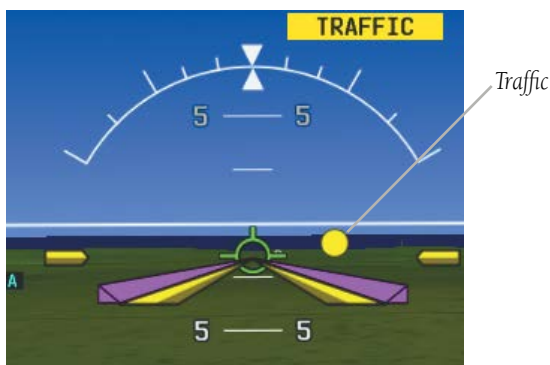

Synthetic Vision Traffic

AIRPORT SIGNS

Airport Signs provide a visual representation of airport location and identification on the synthetic vision display. Airport Signs appear on the display when the aircraft is approximately 15 nm from an airport and disappear at approximately 4.5 nm. Airport signs are shown without the identifier until the aircraft is approximately eight nautical miles from the airport.

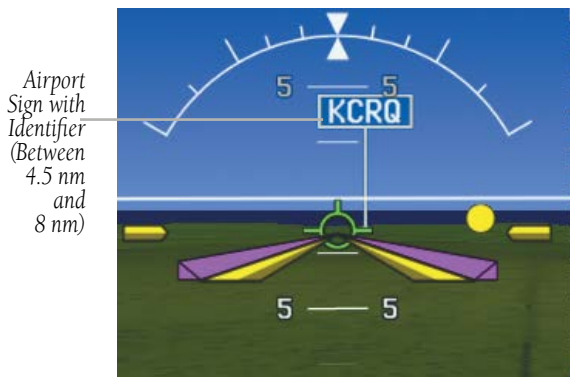

Airport Signs

System Overview

Flight Instruments

EIS

CNS Interface

GPS Navigation

Flight Planning

Hazard Avoidance

Additional Features

AFCS

Annun/Alerts

Appendix

Index

RUNWAYS



WARNING: Do not use Synthetic Vision runway depictions as the sole means for determining the proximity of the aircraft to the runway or for maintaining the proper approach path angle during landing.



NOTE: Not all airports have runways with endpoint data in the database, therefore, these runways are not displayed.

Runway data provides improved awareness of runway location with respect to the surrounding terrain. All runway thresholds are depicted at their respective elevations as defined in the database. In some situations, where threshold elevations differ significantly, crossing runways may appear to be layered. As runways are displayed, those within 45 degrees of the aircraft heading are outlined in white. Other runways (those NOT aligned with the aircraft heading) are outlined in gray. When an approach for a specific runway is active, that runway appears brighter and is outlined with a white box, regardless of the runway orientation as related to aircraft heading. As the aircraft gets closer to the runway, more detail such as runway numbers and centerlines are displayed.

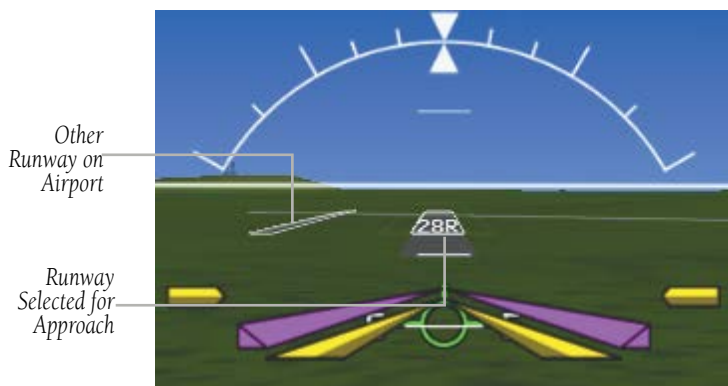

Airport Runways

SYNTHETIC VISION TERRAIN AND OBSTACLE DATA

Terrain alerting on the synthetic vision display corresponds to the red and yellow X symbols on the Inset Map (GDU™ 460 only) and Navigation Map. For more detailed information regarding Synthetic Vision Terrain and Obstacle Data, refer to the Hazard Avoidance Section.

In some instances, a terrain or obstacle alert may be issued with no conflict shading displayed on the synthetic vision. In these cases, the conflict is outside the Synthetic Vision field of view and the alert will have arrows indicating the direction of the alert.



PFD Terrain Alert



MFD Terrain Alerts

Obstacles are represented on the synthetic vision display by standard two-dimensional tower symbols found on the Inset Map (GDU 460 Only) and Navigation Map. Obstacle symbols appear in the perspective view with relative height above terrain and distance from the aircraft. Unlike the Inset Map and Navigation Map display, obstacles on the synthetic vision display do not change colors to warn of potential conflict with the aircraft's flight path until the obstacle is associated with an actual terrain alert. Obstacles greater than 1000 feet below the aircraft altitude are not shown. Obstacles are shown behind the airspeed and altitude displays.

Arrows indicate the obstacle is outside the Synthetic Vision field of view.



Obstacle Outside the Synthetic Vision Field of View



Synthetic Vision Obstacle Alerts

During unusual attitude conditions or when the terrain gradient is great enough to completely fill the display, a brown (earth) or blue (sky) colored bar at the top or bottom of the screen is displayed to prevent the pilot from losing sight of the horizon.



Blue Sky Bar with Full Display Terrain

SYNTHETIC VISION FIELD OF VIEW

The PFD field of view can be represented on the MFD Navigation Map Page. Two dashed lines forming a V-shape in front of the aircraft symbol on the map, represent the forward viewing area shown on the PFD.

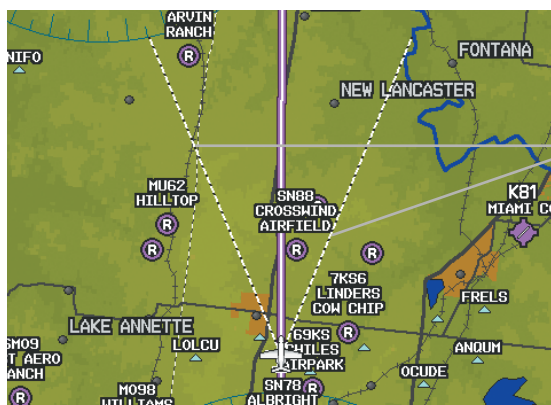

Synthetic Vision Field of View

Configuring field of view:

- 1) With Synthetic Vision enabled, from the Map Page press the **MENU** Key.
- 2) Touch **Set Up Map**.
- 3) Touch and drag the tabs to scroll.
- 4) Touch the **Miscellaneous** Tab.
- 5) Touch the **Field of View** .
- 6) Touch **On** or **Off**.

8.2 SAFETAXI®

SafeTaxi is an enhanced feature that gives greater map detail when viewing airports at close range. When viewing at ranges close enough to show the airport detail, the map reveals taxiways with identifying letters/numbers, runway incursion “Hot Spots”, and airport landmarks including ramps, buildings, control towers, and other prominent features. Resolution is greater at lower map ranges. The SafeTaxi feature can be seen on the Map Page and the Waypoint Page

Designated Hot Spots are recognized at airports with many intersecting taxiways and runways, and/or complex ramp areas. Airport Hot Spots are outlined to caution pilots of areas on an airport surface where positional awareness confusion or runway incursions happen most often. Hot Spots are defined by magenta outlines.

During ground operations the aircraft’s position is displayed in reference to taxiways, runways, and airport features. When panning over the airport, features such as runway holding lines and taxiways are shown at the cursor.

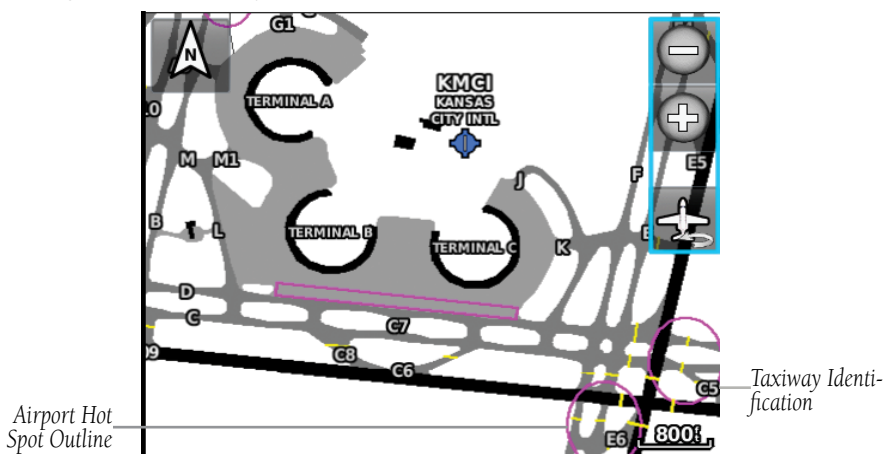

SafeTaxi Depiction on the Map Page

Enabling/disabling SafeTaxi:

- 1) From the Map Page press the **MENU** Key.
- 2) Touch **Set Up Map**.
- 3) Touch and drag the tabs to scroll.
- 4) Touch the **Airport** Tab.
- 5) Touch and drag to scroll down

6) Touch the **SafeTaxi** .

7) Touch **On** or **Off**.

SAFETAXI CYCLE NUMBER AND REVISION

The SafeTaxi database is provided by Garmin. Refer to Appendix C for instructions on updating the SafeTaxi database.

8.3 CHARTVIEW



WARNING: Do not use the approach information provided by the VFR navigation database residing within the G3X Touch as a means of navigating any instrument approach. The G3X Touch VFR navigation database is limited to present only the waypoints for the final approach leg of a published procedure. These waypoints and associated course line are made available for monitoring purposes only.

ChartView resembles the paper version of Jeppesen terminal procedure charts. The MFD depiction displays the aircraft position on the moving map in the plan view of the approach charts and on airport diagrams.

ChartView database is revised every 14 days. Charts are still viewable during a period that extends from the cycle expiration date to the disabled date. ChartView is disabled 70 days after the expiration date and is no longer available for viewing. When turning on the system, the initial page displays the current status of the ChartView database.

The ChartView database subscription is available from Jeppesen, Inc. Available data includes:

- Arrivals (STAR)
- Departure Procedures (DP)
- Approaches
- Airport Diagrams
- NOTAMs

The geo-referenced aircraft position is indicated by an aircraft symbol displayed on the chart when the current position is within the boundaries of the chart. Inset boxes are not considered within the chart boundaries. Therefore, when the aircraft symbol reaches a chart boundary line, or inset box, the aircraft symbol is removed from the display.

The figure below, shows examples of off-scale areas, indicated by the grey shading. Note, the grey shading is for illustrative purposes only and will not appear on the published chart or display. These off-scale areas appear on the chart to convey supplemental information. However, the depicted geographical position of this information, as it relates to the chart planview, is not the actual geographic position. Therefore, when the aircraft symbol appears within one of these areas, the aircraft position indicated is relative to the chart planview, not to the off-scale area.

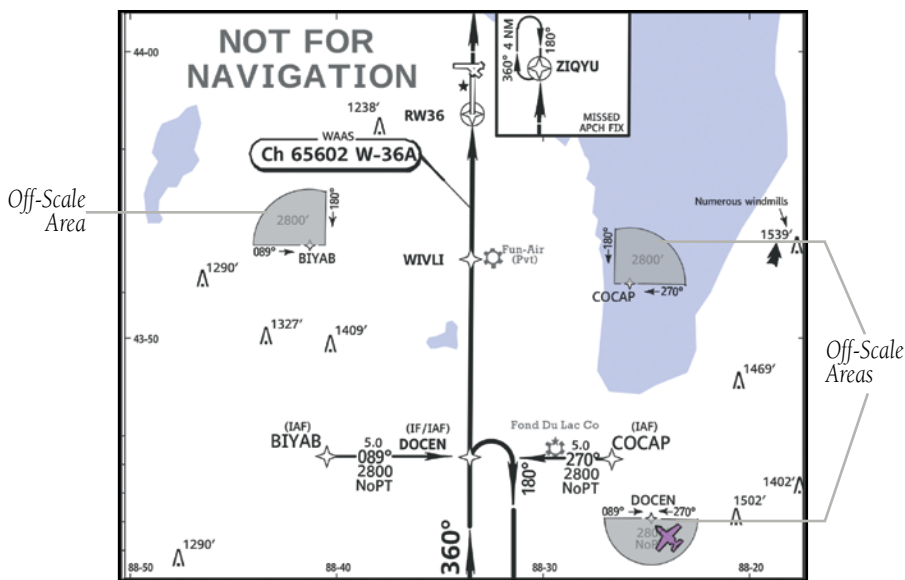

Sample Chart Indicating Off-Scale Areas

Displaying ChartView:

- 1) From the Waypoint Page, touch the **Charts** Tab.
- 2) If necessary, touch the Waypoint Identifier Field at the top of the page.
- 3) Enter the desired airport using the keypad or the **Find** option.
- 4) Touch  to display a list of charts.
- 5) Touch the desired chart from the list.

When a terminal procedure chart is not available for the requested airport or there is an error rendering the data, the banner “Chart Not Available” appears on the screen. The “Chart Not Available” banner does not refer to the ChartView subscription, but rather the availability of a particular airport chart selection or procedure for a selected airport.



Chart Not Available Banner

AIRCRAFT SYMBOL

The aircraft symbol is shown in magenta on the chart when the chart is to scale and the aircraft position is within the boundaries of the chart.

CHART RANGE

Changing the chart range:

From the Waypoint Page with the **Charts** Tab selected, touch - or + to change the range.

CHART EXPAND BUTTON

The Chart Expand Button in the lower left hand corner of the chart (Waypoint Page > Charts Tab) quickly expands the chart.

Expanding the chart:

From the Waypoint Page with the **Charts** Tab selected, touch the Chart Expand Button. Touch the Chart Expand Button again to resume normal viewing.

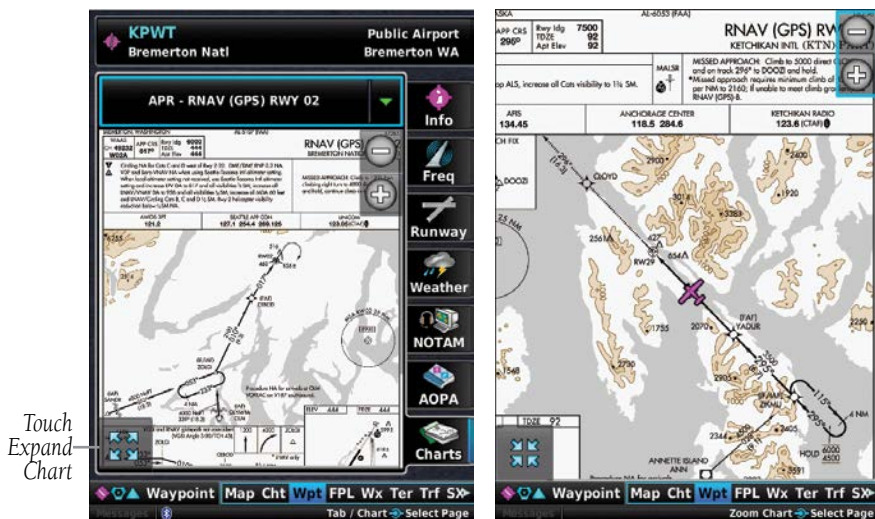

Chart Expand Button

NAVIGATION DATABASE-PUBLISHED NOTAMS



NOTE: Only NOTAMs for the selected airport is shown (when available). There may be other NOTAMs available pertaining to the flight that may not be displayed. Contact Jeppesen for more information regarding Jeppesen database-published NOTAMs.

Recent NOTAMs applicable to the current ChartView cycle are included in the ChartView database. If NOTAMs are available for the selected airport, a 'Chart NOTAMs' option will be displayed at the bottom of the drop-down menu of available charts. Select the 'Chart NOTAMs' option from the chart menu to display the applicable NOTAM information.

8.4 FLITECHARTS[®]



WARNING: Do not use the approach information provided by the VFR navigation database residing within the G3X Touch as a means of navigating any instrument approach. The G3X Touch VFR navigation database is limited to present only the waypoints for the final approach leg of a published procedure. These waypoints and associated course line are made available for monitoring purposes only.

FliteCharts resemble the paper version of National Aeronautical Charting Office (NACO) terminal procedures charts. The charts are displayed with high-resolution and in color for applicable charts. FliteCharts database subscription is available from Garmin. Available data includes:

- Arrivals (STAR)
- Departure Procedures (DP)
- Approaches
- Airport Diagrams
- Takeoff Minimums
- Alternate Minimums

The geo-referenced aircraft position is indicated by an aircraft symbol displayed on the chart when the current position is within the boundaries of the chart. An aircraft symbol may be displayed within an off-scale area depicted on some charts.

The figure below shows examples of off-scale areas, indicated by the grey shading. Note, these areas are not shaded on the published chart. These off-scale areas appear on the chart to convey supplemental information. However, the depicted geographical position of this information, as it relates to the chart planview, is not the actual geographic position. Therefore, when the aircraft symbol appears within one of these areas, the aircraft position indicated is relative to the chart planview, not to the off-scale area.

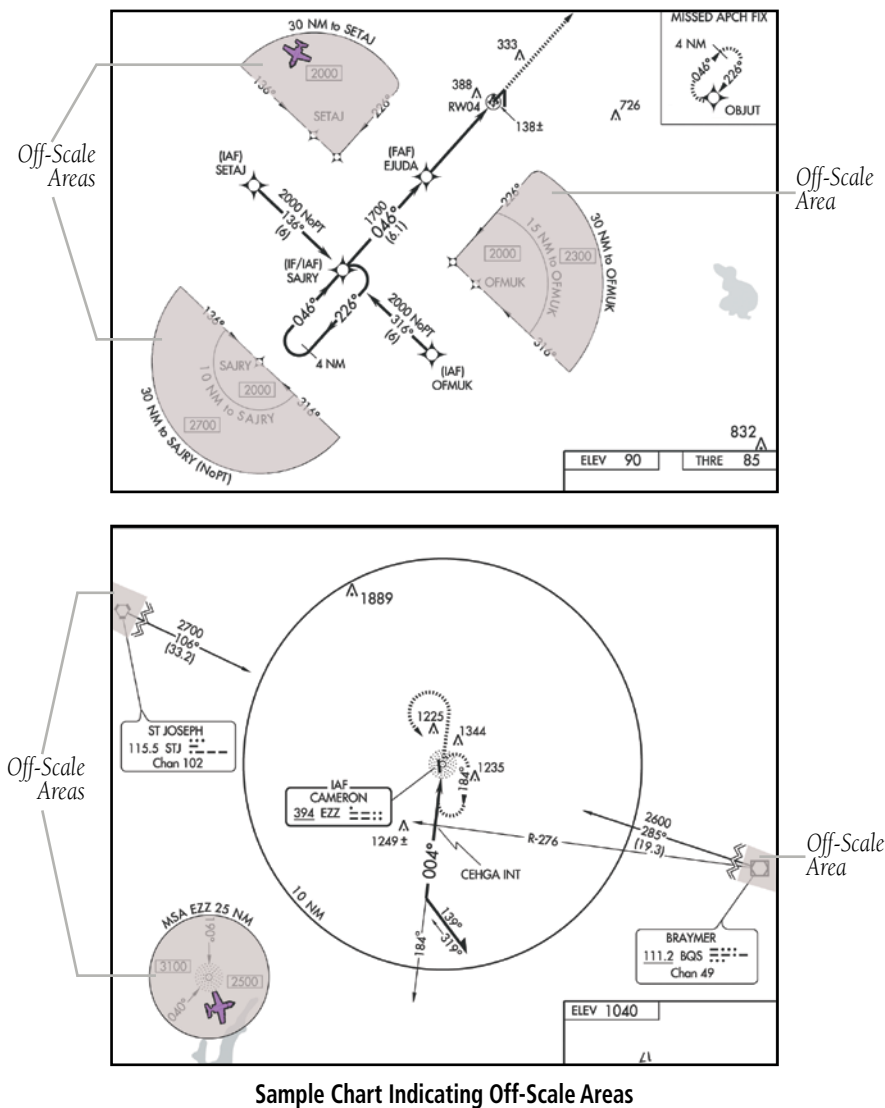

Sample Chart Indicating Off-Scale Areas



NOTE: Do not maneuver the aircraft based solely upon the geo-referenced aircraft symbol.

- System Overview
- Flight Instruments
- EIS
- CNS Interface
- GPS Navigation
- Flight Planning
- Hazard Avoidance
- Additional Features
- AFCS
- Annun/Alerts
- Appendix
- Index

Displaying FliteCharts:

- 1) From the Waypoint Page, touch the **Charts** Tab.
- 2) If necessary, touch the Waypoint Identifier Field at the top of the page.
- 3) Enter the desired airport using the keypad or the **Find** option.
- 4) Touch  to display a list of charts.
- 5) Touch the desired chart from the list.

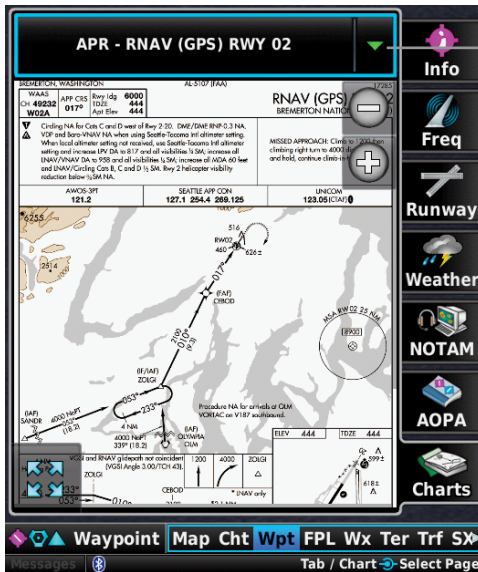

Touch to view Available Approaches

FliteCharts

When a terminal procedure chart is not available for the requested airport or there is an error rendering the data, the banner “Chart Not Available” appears on the screen. The “Chart Not Available” banner does not refer to the FliteCharts subscription, but rather the availability of a particular airport chart selection or procedure for a selected airport.



Chart Not Available Banner

AIRCRAFT SYMBOL

The aircraft symbol is shown in magenta on the chart only if the chart is to scale and the aircraft position is within the boundaries of the chart. The aircraft symbol is not displayed when the Aircraft Not Shown Icon appears. The Aircraft Not Shown Icon may appear at certain times, even if the chart is displayed to scale.

CHART RANGE

Changing the chart range:

From the Waypoint Page with the TERPs Tab selected, touch - or + to change the range.

FLITECHARTS CYCLE NUMBER AND EXPIRATION DATE

FliteCharts data is revised every 28 days. FliteCharts do not expire and will remain viewable after the expiration date. There are four different possible criteria for chart availability. These indications are whether the databases are not configured, not available, current or out of date.

8.5 AIRPORT DIRECTORY DATA

The Airport Directory contains airport statistics such as pattern altitudes, noise abatement information, FBO phone numbers, hours of operation, local attractions, ground transportation, lodging, and services.

The AOPA Airport Directory provides data on airports and heliports throughout the U.S. and it is updated on a 56-day cycle. Detailed information for over 5,300 U.S. airports, along with the names and phone numbers of thousands of FBOs can be viewed. This service allows the pilot to plan an overnight, choose fuel stops, find ground transportation, etc.

Optional airport directory databases such as AC-U-KWIK are also supported. AC-U-KWIK provides complete listings of FBOs, charter companies, fuel suppliers, ground transportation, maintenance and catering services at public airports across the world.



If the AOPA database is in use, the **AOPA** Tab is displayed on the Waypoint (Wpt) Page. If another airport directory database is in use, such as AC-U-KWIK, the **DIRECTORY** Tab is displayed on the Waypoint (Wpt) Page.

Viewing Airport Directory information:

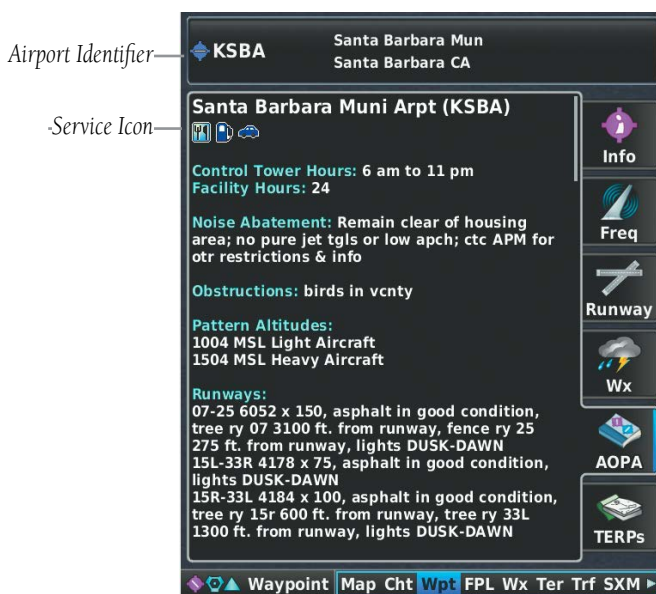
From the Waypoint (WPT) Page, touch the **AOPA** or **DIRECTORY** Tab.



Airport Directory Information

Icon	Description
	Restaurant on Field
	Self Serve Fuel
	Courtesy Car

Airport Directory Service Icons

8.6 SIRIUSXM RADIO ENTERTAINMENT (OPTIONAL)



NOTE: See the *G3X Touch Installation Manual* for SiriusXM activation instructions.



NOTE: SiriusXM Radio is only available with the an optional SiriusXM capable radio and a SiriusXM subscription.



NOTE: Refer to the Hazard Avoidance Section for information about Weather products.

SiriusXM Satellite Radio offers a variety of radio programming over long distances without having to constantly search for new stations. Based on signals from satellites, coverage far exceeds land-based transmissions. SiriusXM Satellite Radio services are subscription-based.

ACTIVATING SIRIUSXM SATELLITE RADIO SERVICES

The service is activated by providing SiriusXM Satellite Radio with a coded ID (Radio ID).

Accessing the Radio ID:

View on the Data Link Information Page from the tab of the appropriate device (GDU, GDL®).

USING SIRIUSXM RADIO

The SXM Page provides information and control of the audio entertainment features of the SiriusXM Satellite Radio.

Selecting the SXM Page:

- 1) Touch the Page Navigation Bar.
- 2) Touch **SiriusXM Audio**.

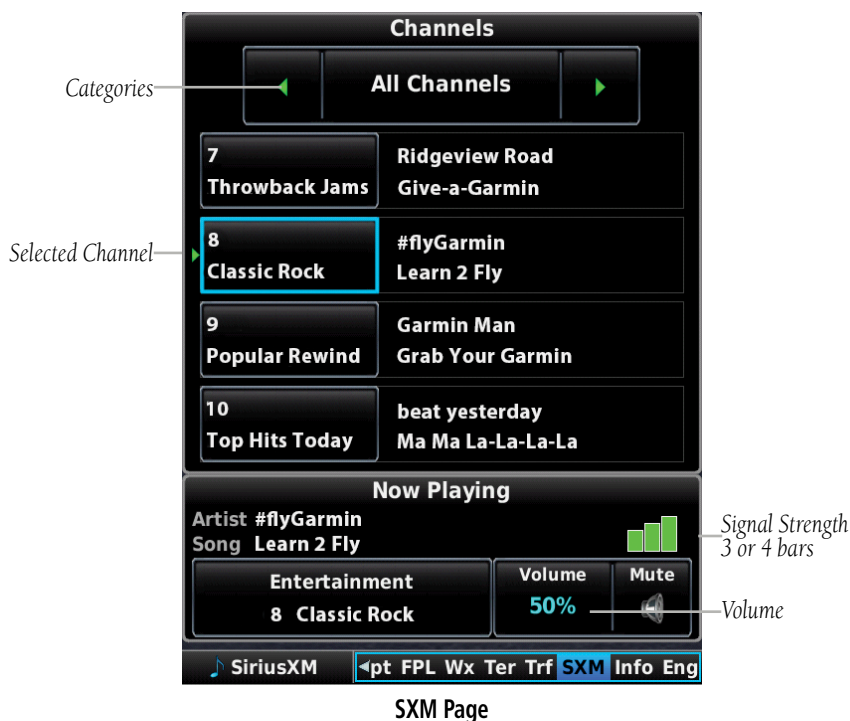

Selecting a category:

From the SXM Page, touch  to cycle through the categories or select from the drop down list.

Selecting a channel:

From the SXM Page, touch a Channel to select it.

Or:

Touch the Now Playing Channel Button and enter the desired channel number.

Adding a channel to Favorites:

- 1) From the SXM Page, touch a Channel to select it.
- 2) Press the **MENU** Key.
- 3) Touch **Add to Favorites**.

Selecting Favorites:

From the SXM Page, touch  to cycle through the categories until you see the Favorites Category.

Deleting a channel from Favorites:

- 1) With a Favorite Channel selected, press the **MENU** Key.
- 2) Touch **Remove Favorite**.
- 3) Touch **Yes**.

VOLUME

Adjusting the volume:

From the SXM Page, touch the volume, and touch the volume slider to adjust the volume.

Or:

Use the Knobs.

8.7 ELECTRONIC CHECKLISTS (OPTIONAL)



NOTE: The information described in this section is not intended to replace the checklist information described in the AFM.



NOTE: Garmin does not create, modify, or update G3X Touch checklists and thus cannot be responsible for the availability and/or content.



NOTE: Checklists cannot be edited from within the system.

The G3X Touch is capable of displaying checklists (if available from the aircraft manufacturer) which allow a pilot to quickly find the proper procedure on the ground and during each phase of flight. The G3X Touch accesses the checklist file (*.ace) from the root directory (/*.ace) of the SD card. If a checklist file is available on the SD card, the Checklists option is available from the Main Menu. The Checklist Editor may be downloaded from the Updates & Downloads page which can be accessed via the G3X or G3X Touch webpage.

8.8 FLIGHT DATA LOGGING USING THE SD CARD

The flight data logging feature automatically stores flight and engine data to an SD card. Data is recorded to the SD card every second. A data file is created each time the system is powered on with an SD card inserted, or each time an SD card is inserted after starting the system. A 2 GB SD card can store over 1,000 hours of flight data or up to 1,000 files (whichever comes first). The data files stored on the SD card have an extension of .csv. This file format can be opened using a spread sheet application. Garmin recommends using a 8 GB SanDisk[®] or Toshiba[®] SD card.

Data Logging must be enabled in Configuration Mode.

8.9 CONNEXT COCKPIT CONNECTIVITY

Connex allows the sharing of data between devices via Bluetooth[®] or serial connection. For example:

- Flight plans are wirelessly transferred from a mobile device to the G3X Touch or external navigator (if configured).
- An iOS or Android device (with Garmin Pilot™) paired with both a G3X Touch and another compatible device, shares GPS, attitude, traffic and weather data.

Visit www.flygarmin.com for a list of platforms that support Connex.

Connex Bluetooth pairing recommendations:

- Do not attempt to pair the displays to each other in a multiple display installation.
- Turn off the Bluetooth transceiver for any display which is not using it.



NOTE: In general one or two iOS or Android devices running Garmin Pilot may be connected as shown below. Due to the wide variability of these devices, the best user experience may, in some cases, be limited to a single mobile device connected to the system components.

Connex Bluetooth Supported Configurations	
<p>One or two Android or iOS devices may be connected to the G3X Touch</p>	
<p>One Android or iOS device may be connected to both a GDL and a G3X Touch.</p> <p>A second Android or iOS device may be connected to either a GDL or the G3X Touch, but not both.</p>	

PAIRING THE G3X TOUCH WITH A BLUETOOTH DEVICE

Pairing the G3X Touch with a Bluetooth device:



NOTE: For iOS and Android devices, the Bluetooth pairing to the G3X Touch may be established from the iOS or Android Bluetooth settings page with the G3X touch Bluetooth Setup Page selected and visible.

- 1) Power on the Bluetooth device and ensure Bluetooth is turned on in Settings.
- 2) Refer to the iOS or Android device's documentation for instructions on making the device discoverable.
- 3) Refer to the iOS or Android device's documentation for instructions on finding the device name. Take note of the device name as it is the name you will want to select in step 8.
- 4) Press the **MENU** Key twice.
- 5) Touch **Setup > Bluetooth**.
- 6) Touch **On**. The G3X Touch will begin searching for devices.
- 7) When the G3X Touch has completed the search for available devices, touch **Not Paired** next to the iOS or Android device to be paired.

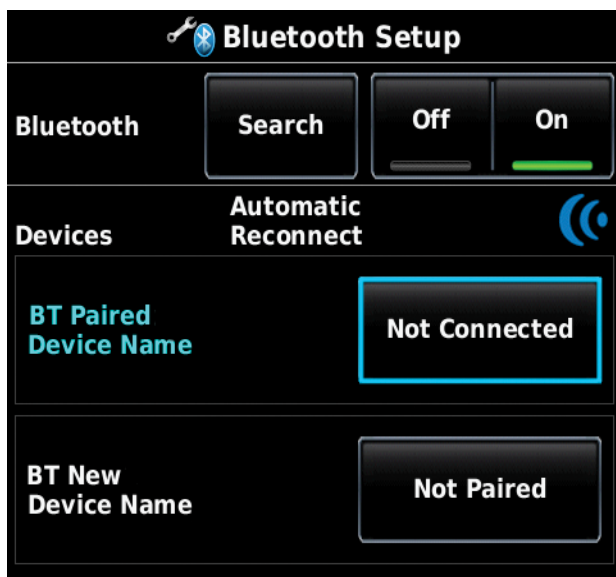

Bluetooth Setup

- 8) The first time a device is paired, a Bluetooth Passkey Window may be displayed to confirm what device you are attempting to pair with. Touch **OK** to confirm the passkey. When the device is paired, **Connected** is displayed next to the device.

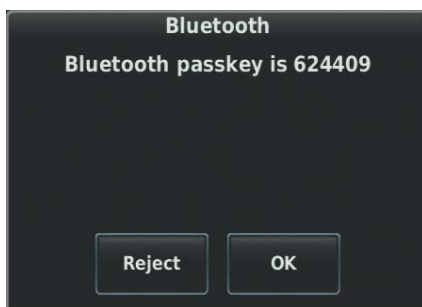

Bluetooth Passkey Window

TRANSFERRING A FLIGHT PLAN

Transferring a flight plan from a Bluetooth device to the G3X Touch:

- 1) If not already paired, pair the iOS or Android device to the G3X Touch. Refer to the previous procedure. NOTE: Previously paired devices can be set to make future connections automatic.
- 2) Install (if not already installed) and open the Garmin Pilot App on the iOS/Android device.
- 3) If an external navigator is configured, touch **FPL Source > Internal** or **FPL Source > External** on the Flight Plan Page of the G3X Touch.
- 4) Send a flight plan to the G3X Touch from the Garmin Pilot App on the device. Refer to the Garmin Pilot Help File for more information on sending a flight plan to a navigator.
- 5) Tell the G3X Touch or external navigator what to do with the transferred flight plan:

If **FPL Source > Internal** is selected on the Flight Plan Page, a **Flight Plan Received** notification is displayed on the G3X Touch. Touch one of the following:

Ignore: Discard the flight plan.

Store: Save the flight plan to the Flight Plan List.

Activate: Activate the flight plan without saving it to the Flight Plan List.



Flight Plan Received Notification

Or:

If **FPL Source > External** is selected on the Flight Plan Page, the flight plan is automatically pushed to the external navigator. A message flashes on the external navigator to prompt the pilot to review and accept the flight plan. The pilot can then choose to save or activate the transferred flight plan on the external navigator.

FLIGHT DATA LOGGING IN GARMIN PILOT



NOTE: Previous flights' data logs will NOT be synced to Garmin Pilot or flygarmin.

Flight Data Logging sends the CSV file to Garmin Pilot on an iOS device. When transferred to the iOS device the Flight Data Log is attached to an appropriate logbook entry, or a new one is created. The logbook entry with the Flight Data Log is also synced to flyGarmin.

Transferring the flight data log (CSV file) to Garmin Pilot via Context:

- 1) If not already paired, pair the iOS device to the G3X Touch. Refer to the "Pairing the G3X Touch with a Bluetooth device" procedure above. NOTE: Previously paired devices can be set to make future connections automatic.

- 2) Install (if not already installed) and open the Garmin Pilot App on the iOS device.
- 3) If this is the first time using Flight Data Logging with Garmin Pilot, an alert to consent to collection of flight data will appear. Tap **Enable Data Log Transfer** on Garmin Pilot.

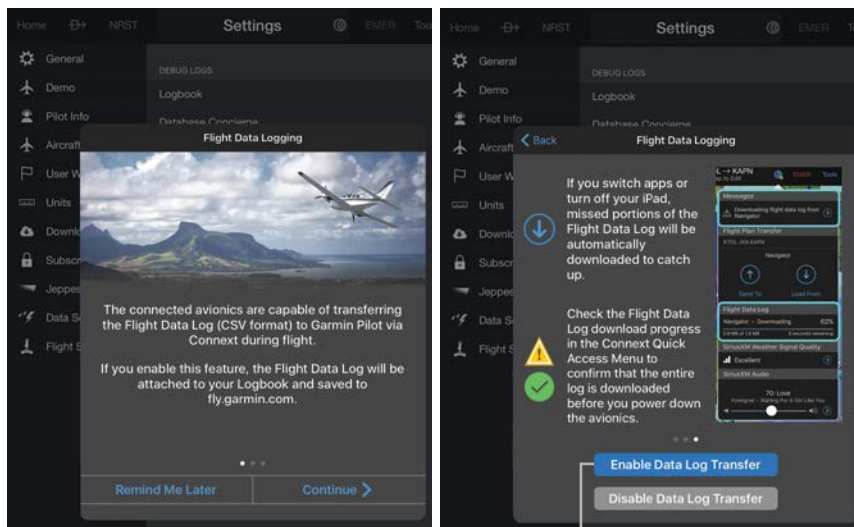

Tap to enable data log transfer

Flight Data Logging on Garmin Pilot

- 4) Tap the blue Connex icon  in the app's bezel to display the status of the flight data collection.

Tap to display flight data collection status

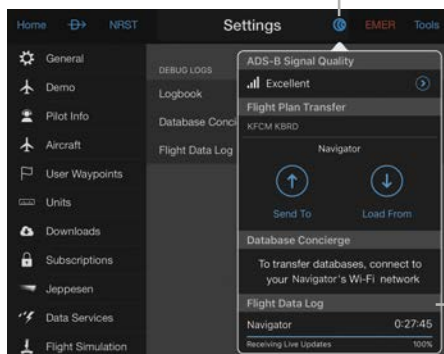

Flight Data Log status

Flight Data Log Status on Garmin Pilot

- After the flight, disconnect from the avionics (power off the G3X Touch or disable Bluetooth on the iOS device). The app will attach the flight log to an existing logbook entry that matches the flight, or create a new one.



NOTE: Tap to confirm the entire flight log is downloaded before turning off the avionics.

- From Garmin Pilot, tap **Home** > **Logbook** > **Entries** > **Auto-Generated Flight Logs** to view the Flight Log.
- Tap the Auto-Generated Flight Log and tap **Accept** to add the entry to the logbook.

Auto-Generated Flight Logs

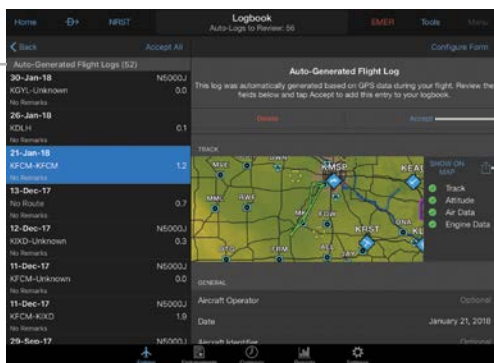

Tap to add the Flight Log to the logbook
Tap to share Flight Log

Flight Data Log on Garmin Pilot

- Optional: From the logbook entry in Garmin Pilot, tap to share the Flight Data Log.

Pairing the G3X Touch to a GDL:



NOTE: Lightning, Cloud Tops Forecast, Turbulence Forecast, and Icing Forecast FIS-B weather products are only available over a Bluetooth connection. Even if the G3X Touch is connected via RS-232 to the ADS-B receiver, it is recommended to add a Bluetooth connection to receive these weather products.

- Power on the GDL. The GDL will automatically enter Bluetooth pairing mode.
- Press the **MENU** Key twice.
- Touch **Setup** > **Bluetooth**.
- If Bluetooth is set to **Off**, touch the **Bluetooth**

- 5) Touch **On**. The G3X Touch will begin searching for devices.
- 6) When the G3X Touch has completed the search for available devices, touch **Not Paired** next to the GDL.
- 7) The first time a device is paired, a Bluetooth Passkey Screen will be displayed to confirm what device you are attempting to pair with. Touch **OK** to confirm the passkey. When the device is paired, **Connected** is displayed next to the device.

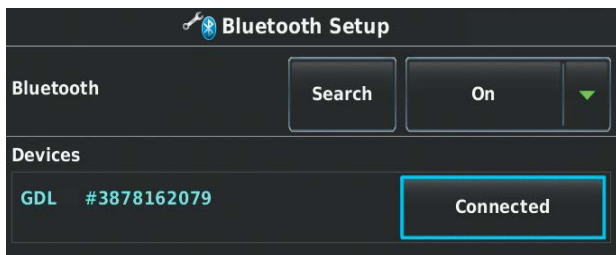

Bluetooth Setup

- 8) Press the **BACK** Key twice and touch **Data Link** to display the device information.

Data Link Information	
Device	GDL 3.10 3878162079
Status	Connected
GPS Position	Valid (External)
Pressure Altitude	1390'
Ground Uplink Signal	<input type="checkbox"/> <input type="checkbox"/> <input type="checkbox"/> <input type="checkbox"/>
TIS-B Traffic Data	Disabled
Air-To-Air Traffic	Disabled
AIRMETs	--:--
METARs	-00:02
NEXRAD Radar (CONUS)	--:--
NEXRAD Radar (Regional)	--:--
NOTAMs	-00:02
PIREPs	-00:02
SIGMETs	--:--
TAFs	-00:02
Temperatures Aloft	--:--
TFRs	-00:02
Winds Aloft	--:--

Data Link Information

The Bluetooth Setup Menu provides several options for connecting to Bluetooth devices. **Manage Paired Devices** can enable Automatic Reconnect and remove connections on a per-device basis. **Forget all devices** will remove all Bluetooth connections. **Edit GDU Name** is used to change the name the G3X Touch shows other devices while pairing. **Restore Default** will disable Bluetooth and remove all Bluetooth connections.

Managing Connected Bluetooth Devices:

From the **Main Menu**, touch **Setup** > **Bluetooth** > **Menu**.

8.10 ELECTRONIC STABILITY & PROTECTION (ESP-X)



WARNING: Do not assume ESP-X will provide stability protection in all circumstances. There are in-flight situations that can exceed the capabilities of ESP-X technology.



NOTE: Non-Garmin autopilot installations are not supported for ESP-X. ESP-X requires the optional GFC 500 autopilot.

Electronic Stability and Protection (ESP) is an optional feature that is intended to monitor the aircraft and provide control input feedback when necessary to discourage operating the aircraft at potentially unsafe attitudes and/or airspeeds. If enabled, this feature will automatically arm when the aircraft is above 500 feet AGL and the autopilot is not engaged, and disarm when below 200 feet AGL.

When selected, ESP engages automatically when the aircraft approaches or exceeds one or more predetermined airspeed or attitude limitations. Stability protection for each flight axis is provided by the autopilot servos, which apply force to the appropriate control surface(s) to discourage pilot control inputs that would cause the aircraft to exceed the normal or "protected" flight envelope. This is perceived by the pilot as resistance to control movement in the undesired direction when the aircraft approaches a steep attitude, and/or the airspeed is below the minimum or above the maximum configured airspeed.

As the aircraft deviates further from the normal attitude and/or airspeed, the force increases proportionally (up to an established maximum) to encourage control movement in the direction necessary to return to the normal attitude and/or airspeed range.

When ESP has been engaged for more than ten seconds (cumulative; not necessarily consecutive seconds) of a 20-second interval, the autopilot can be configured to engage with the flight director in Level Mode, bringing the aircraft into level flight. An aural “Engaging Autopilot” alert is played and the flight director mode annunciation will indicate ‘LVL’ for vertical and lateral modes.

Level mode as activated by ESP is limited by altitude. ESP will not be able to activate Level mode until the aircraft climbs above 2000 feet AGL. ESP will be locked out of automatically activating Level mode after the aircraft descends below 1500 feet AGL as well. Also note that Level mode as activated by ESP is different than manually selected Level mode. Manually selected Level mode is not limited by altitude at all.



NOTE: *If AGL height data is unavailable (i.e., GPS altitude or terrain data is unavailable), automatic engagement of Level mode is not supported.*

The pilot can interrupt ESP by pressing and holding the Autopilot Disconnect/Control Wheel Steering (AP DISC) switch. If the AP DISC switch is held less than five seconds, upon releasing the AP DISC switch, ESP force will again be applied. If the AP DISC switch is held for five seconds or more while in air, ESP will be disabled and an 'ESP OFF' CAS message is displayed.

When ESP is active it can also be overridden by overpowering the servo's torque limit.

ESP can be enabled or disabled from the Automatic Flight Control System (AFCS) page as follows:

Enabling/disabling ESP using the G3X Touch Autopilot Interface:

- 1) From the PFD, touch the Autopilot Status Box. The Automatic Flight Control System page is displayed.

Or:

From the Main Menu, touch **Flight Controls**.

- 2) Touch the **ESP** button on the Automatic Flight Control System page to enable/disable ESP.

ESP is automatically enabled when starting the system.

- System Overview
- Flight Instruments
- EIS
- CNS Interface
- GPS Navigation
- Flight Planning
- Hazard Avoidance
- Additional Features
- AFCS
- Annun/Alerts
- Appendix
- Index



Autopilot Status Box - Touch To Display the G3X Touch Autopilot Interface

ESP Roll Engagement Indication (ESP NOT Engaged)

G3X Touch Autopilot Interface

Touch To Enable/Disable ESP

AFCS (ESP Enabled)

ROLL ENGAGEMENT

Roll Limit Indicators displayed on the roll scale indicate where ESP will engage. As roll attitude exceeds the configured limit, ESP will engage and the Roll Limit Indicators will move to 15° less than the configured ESP bank limit. The Roll Limit Indicator now indicates where ESP will disengage as roll attitude decreases.

Roll Limit Indicator
ESP Engage (45°)
(Configurable)



ESP Roll Engagement Indication (ESP Enabled but NOT Engaged)

ESP Engage (45°) (Configurable)
Aircraft Roll Attitude = 35°

ESP Disengage (30°)
(15° < Configured Bank Limit)

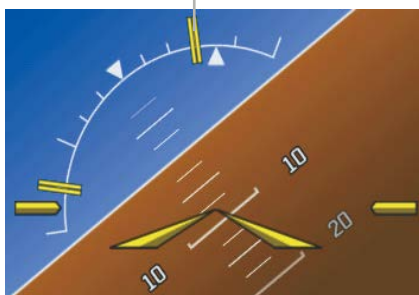
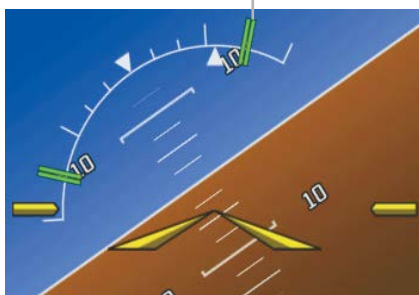

Roll Increasing to ESP Engagement

Once engaged, the torque applied by ESP is at its maximum when bank angle is 15° more than the configured bank limit, and tapers to the minimum applied torque when the bank angle is 15° less than the configured bank limit. The force increases as roll attitude increases and decreases as roll attitude decreases. The applied force is intended to encourage pilot input to return the airplane to a more normal roll attitude. When beyond 15° of the configured bank limit, the maximum torque is held until the aircraft returns inside the protected envelope.

- System Overview
- Flight Instruments
- EIS
- CNS Interface
- GPS Navigation
- Flight Planning
- Hazard Avoidance
- Additional Features
- AFCs
- Annun/Alerts
- Appendix
- Index

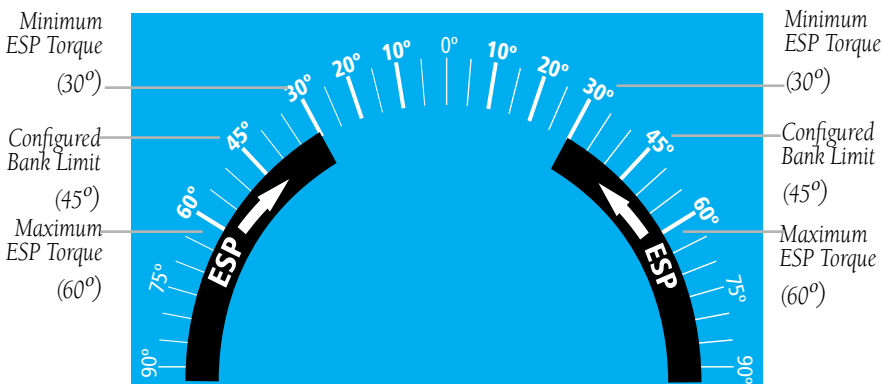

ESP Roll Operating Range When Engaged
 (Force Increases as Roll Increases & Decreases as Roll Decreases)

PITCH ENGAGEMENT

ESP pitch engagement is configurable between 10° and 25° nose-up and between 5° and 25° nose-down. Once engaged, the torque applied by ESP is at its maximum when pitch is 5° more than the configured nose-up and nose-down pitch limits, and tapers to the minimum applied torque when pitch is 5° less than the configured nose-up and nose-down pitch limits. When beyond 5° of the configured pitch limit, the maximum torque is held until the aircraft returns inside the protected envelope.

The opposing force increases or decreases depending on the pitch angle and the direction of pitch travel. This force is intended to encourage movement in the pitch axis in the direction of the normal pitch attitude range for the aircraft.

The presence of yellow chevrons indicate that ESP is engaged in these nose-up/nose-down conditions.

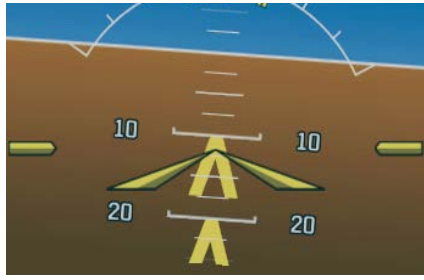

ESP Engaged (Nose-Low)

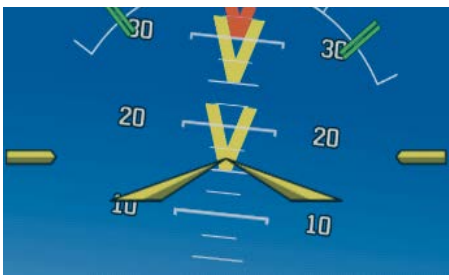

ESP Engaged (Nose-High)

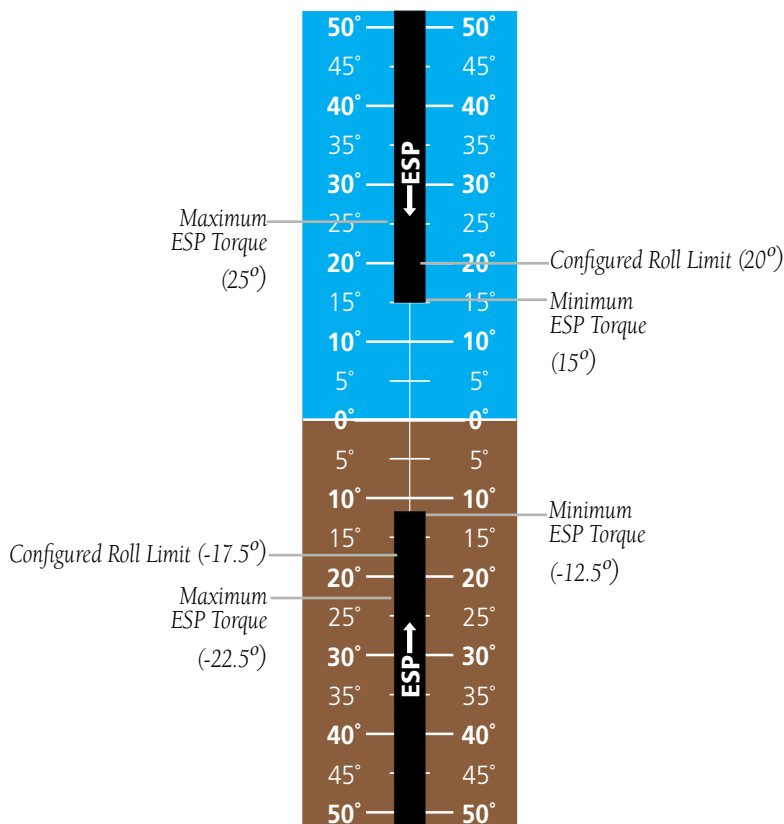

ESP Pitch Operating Range When Engaged
 (Force Increases as Pitch Increases & Decreases as Pitch Decreases)

AIRSPEED PROTECTION



NOTE: If AGL height data is unavailable (i.e., GPS altitude or terrain data is unavailable), low-airspeed protection is not supported.

An airspeed below the minimum configured airspeed or above maximum configured airspeed will result in ESP applying force to raise or lower the nose of the aircraft. When the high or low airspeed condition is remedied, ESP force is no longer applied.

8.11 CARBON MONOXIDE (CO) DETECTOR (OPTIONAL)



NOTE: Refer to the approved Pilot's Operating Handbook (POH) for emergency procedures.

If a carbon monoxide (CO) detector is installed, the current CO measurement in parts per million (ppm) can be displayed in the Data Bar.

Displaying the current CO measurement in the Data Bar field:

- 1) Press the **MENU** Key twice.
- 2) Touch **Setup > Data Fields > Change....**
- 3) Touch one of the Data Bar fields.
- 4) Touch **CO PPM** from the list of data fields.

Carbon monoxide levels are recorded in the G3X Touch data log file as well.

CO Measurement In PPM

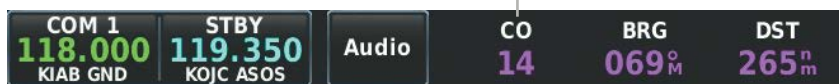

Data Bar

In the event high CO levels are detected, the **CO** data field will flash yellow (if displayed) and a **CO LEVEL** CAS Message is displayed.



CO Data Bar Field (High CO)



High CO CAS Message (PFD)

If the carbon monoxide (CO) detector is inoperative, a **CO FAIL** CAS Message is displayed.



CO Detector is Inoperative

SECTION 9 AUTOMATIC FLIGHT CONTROL SYSTEMS (OPTIONAL)



NOTE: This section describes capabilities and functions of the optional Garmin GFC 500 autopilot system unless otherwise noted.



NOTE: The approved Pilot's Operating Handbook (POH) always supersedes the information in this Pilot's Guide.



NOTE: Refer to the approved Pilot's Operating Handbook (POH) for emergency procedures.



NOTE: VOR, LOC, and GS modes are all GPS-aided. You must have a GPS position to use VOR, LOC, or GS modes.

AFCS SYSTEM ARCHITECTURE

An Automatic Flight Control System (AFCS) is typically comprised of two major components: A Flight Director (FD) and Autopilot servos. The Flight Director provides pitch and roll commands to the autopilot servos. These pitch and rolls commands are displayed on the PFD as Command Bars. When the Flight Director is active the pitch and roll commands can be hand-flown by the pilot or when coupled with the flight director, the autopilot servos drive the flight controls to follow the commands issued by the Flight Director. The Flight Director operates independently of the autopilot servos, but in most cases the autopilot servos can not operate independent of the Flight Director. On G3X Touch™ installations that do not have a separate and independent Flight Director, the Flight Director is always coupled to the autopilot. The autopilot and optional yaw damper operate the flight control surface servos to provide automatic flight control.

AFCS AND YAW DAMPER OPERATION

The optional yaw damper reduces Dutch roll tendencies, coordinates turns, and provides a steady force to maintain directional trim. It can operate independently of the autopilot and may be used during normal hand-flight maneuvers. Yaw rate commands are limited to 6 deg/sec by the yaw damper.

FLIGHT CONTROL

Pitch and roll commands are provided to the servos based on the active flight director modes. Yaw commands are provided by the yaw servo. Servo motor control limits the maximum servo speed and torque. Torque values are set at installation. This allows the servos to be overridden in case of an emergency. Non-Garmin autopilot systems may not allow servos to be overridden, consult the non-Garmin autopilot documents for limitations.

PITCH AXIS AND TRIM

The autopilot pitch axis uses pitch rate to stabilize the aircraft pitch attitude during flight director maneuvers. Flight director pitch commands are rate and attitude-limited, combined with pitch damper control, and sent to the pitch servo motor. The pitch servo measures the output effort (torque) and optionally provides this signal to the pitch trim motor. The pitch servo commands the pitch trim motor to reduce the average pitch servo effort.

ROLL AXIS

The autopilot roll axis uses roll rate to stabilize aircraft roll attitude during flight director maneuvers. The flight director roll commands are rate- and attitude-limited, combined with roll damper control, and sent to the roll servo motor.

YAW AXIS

The optional yaw damper uses yaw rate and roll attitude to dampen the aircraft's natural Dutch roll response. It also uses lateral acceleration to coordinate turns and reduce or eliminate the need for the pilot to use rudder pedal force to maintain coordinated flight during climbs and descents.

G3X TOUCH AFCS STATUS BOX

The AFCS status box displays Autopilot (AP), Optional Yaw Damper (YD), Flight Director (FD) mode annunciations on the PFD, and Autopilot Preflight Test (PFT).

Autopilot (AP) status is displayed on the far left of the G3X Touch Autopilot Status Box. Lateral modes are displayed in the center, and vertical modes are displayed on the right. Armed modes are displayed in white and active in green.

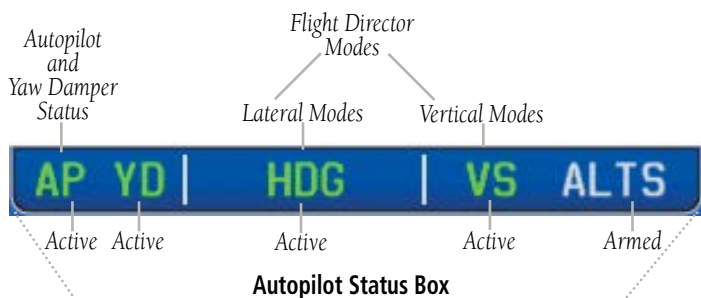

Autopilot Display

Autopilot
Preflight Test

Autopilot Preflight Test

9.1 AFCS OPERATION

When a GMC AFCS Mode Control Unit is installed AFCS functionality is distributed across the following Line Replaceable Units (LRUs):

- GDU™ 4X0 Display Units
- GSA 28 AFCS Pitch/Roll/Yaw Damper/Pitch Trim servos
- GSU 25D ADAHRS Unit
- GMC AFCS Mode Control Unit

The AFCS system can be divided into these main operating functions:

- **Flight Director (FD)** — Flight director operation takes place within the GDU™ 460. Flight director commands are displayed on the PFD. The flight director provides:
 - Command Bars showing pitch/roll guidance
 - Vertical/lateral mode selection and processing
 - Autopilot communication
- **Autopilot (AP)** — Autopilot operation occurs within the pitch, roll, and yaw servos. It also provides servo monitoring and automatic flight control in response to flight director steering commands, Air Data and Attitude and Heading Reference System (ADAHRS) attitude, rate information, and airspeed.
 - **Yaw Damper (YD)** — The yaw servo (optional), is self-monitoring and provides Dutch roll damping and turn coordination in response to yaw rate, roll angle, lateral acceleration, and airspeed. If installed the YD comes on when the autopilot is engaged and stays on after disengaging the autopilot. The YD can be turned on/off independent of the autopilot using the **YD Key**.
 - **Manual Electric Trim (MET)** — Manual electric trim provides trim capability for the pitch axis when the autopilot is not engaged.

The G3X Touch can also communicate with various non-Garmin autopilot units. With an appropriate non-Garmin autopilot installed and the G3X Touch Analog Autopilot Interface is configured (refer to the G3X Touch Installation Manual), the G3X Touch issues course and heading information to the autopilot unit. The autopilot unit is then responsible for moving the flight controls. The G3X Touch system will not display flight director, modes, or annunciations for a non-Garmin autopilot system.



NOTE: Refer to the *G3X Touch Installation Manual* and the non-Garmin autopilot vendor documentation for information on installing and configuring the G3X Touch Analog Autopilot Interface.



NOTE: Refer to the non-Garmin autopilot vendor documentation for stand-alone autopilot functionality and control features.



NOTE: When the autopilot is engaged with auto trim enabled, moving the MET Switch will disengage the autopilot.

AFCS PRE-FLIGHT ACTIONS

To ensure the Automatic Flight Control System (AFCS) is operating properly prior to flight, perform the following Garmin recommended preflight checks.

Before takeoff checklist - Garmin GFC 500:

- 1) Autopilot - ENGAGE (using AP button, or **AP** button on mode controller)
- 2) **AP** DISC button - PRESS (verify autopilot disengages and audio alert is heard)
- 3) Verify yaw damper - OFF (if installed) (verify yaw damper disengages and audio alert is heard)
- 4) Flight director - SET FOR TAKEOFF (select TO or VS mode or push FD Button to turn off the Flight Director)
- 5) Flight controls - CHECK (verify autopilot servos are disengaged from pitch, roll, and yaw controls, and all controls move freely)
- 6) Elevator trim control - SET FOR TAKEOFF

AFCS CONTROLS

GMC 507 AFCS CONTROLS

The GMC 507 AFCS Control Units have the following controls:

- | | | |
|---------------------|--------------------------------|---|
| System Overview | ① HDG Key | Selects/deselects Heading Select Mode |
| Flight Instruments | ② NAV Key | Selects/deselects Navigation Mode. Cancels GS Mode if LOC Mode is either active or armed. Cancels GP Mode if GPS Mode is either active or armed. Cancels LOC Mode if GPS Mode is active and LOC Mode is armed. |
| EIS | ③ AP Key | Engages/disengages the autopilot |
| CNS Interface | ④ LVL Key | Engages the autopilot (if the autopilot is disengaged) in level vertical and lateral modes |
| GPS Navigation | ⑤ NOSE UP/DN Wheel | Adjusts the vertical mode reference in Pitch Hold, Vertical Speed, Indicated Airspeed, and Altitude Hold modes |
| Flight Planning | ⑥ IAS Key | Selects/deselects Indicated Airspeed Mode |
| Hazard Avoidance | ⑦ ALT Key | Selects/deselects Altitude Hold Mode |
| Additional Features | ⑧ VNV Key | Selects/deselects Vertical Path Tracking Mode for Vertical Navigation flight control |
| AFCS | ⑨ VS Key | Selects/deselects Vertical Speed Mode |
| Annun/Alerts | ⑩ YD Key (if installed) | Engages/disengages the yaw damper |
| Appendix | ⑪ FD Key | Activates/deactivates the flight director only
Pressing once turns on the director in the default vertical and lateral modes. Pressing again deactivates the flight director and removes the Command Bars. If the autopilot is engaged, the key is disabled. |
| Index | ⑫ APR Key | Selects/deselects Approach Mode |
| | ⑬ HDG/TRK Knob | Selects the desired Heading/Track |
| | ⑭ ALT SEL Knob | Selects the desired Altitude setting |
| | ⑮ TRK Key | Selects/deselects Track (TRK) Mode |

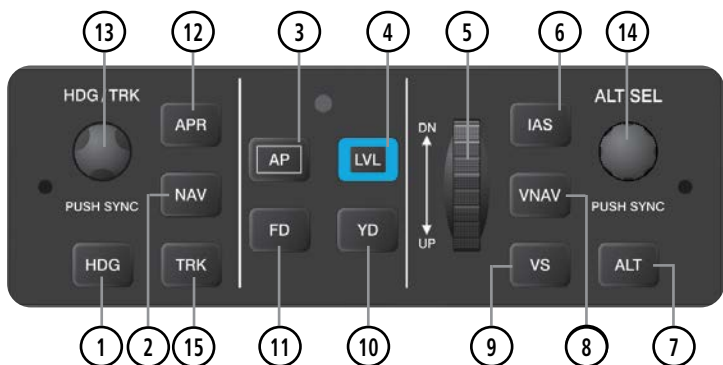

GMC 507 AFCS Control Unit

G3X TOUCH AUTOPILOT INTERFACE

Accessing the G3X Touch AFCS interface:

Touch the AFCS Status Box on the PFD.

Or:

- 1) Press the **MENU** Key twice.
- 2) Touch the **Flight Controls** button.

See figure on following page to view on screen controls.

HDG	Selects/deselects heading mode
NAV	Selects/deselects navigation mode. Cancels GS Mode if LOC Mode is either active or armed. Cancels GP Mode if GPS Mode is either active or armed. Cancels LOC Mode if GPS Mode is active and LOC Mode is armed.
TRK	Selects/deselects track mode
AP	Engages/disengages the autopilot.
LVL	Engages the autopilot (if the autopilot is disengaged) in level vertical and lateral modes
Nose Up / Nose Down	Adjusts the vertical mode reference in Pitch Hold, Vertical Speed, Indicated Airspeed, and Altitude Hold modes
IAS	Selects/deselects Indicated Airspeed Mode
ALT	Selects/deselects Altitude Hold Mode

VNAV	Selects/deselects vertical navigation
or	
APPR	Selects/deselects approach mode
VS	Selects/deselects Vertical Speed Mode
FD	Activates/deactivates the flight director only

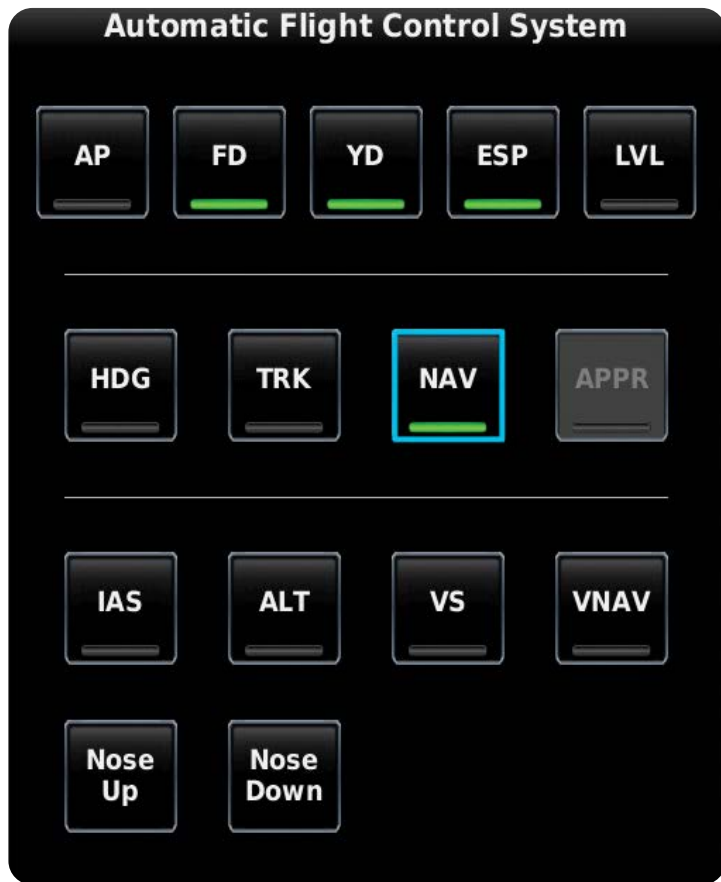

G3X Touch AFCS Controls

The following AFCS controls are located separately from the GDU and GMC 507 AFCS Control Unit:

AP DISC Button (Autopilot Disconnect)

Press and release the AP DISC Button to disengage the autopilot. Pressing and releasing the button again will acknowledge an autopilot disconnect alert and mute the associated aural tone.

Pressing and holding the AP DISC Button will also interrupt Manual Electric Trim.

TO/GA Button (Takeoff/Go Around)

Selects flight director Takeoff (on ground) or Go Around (in air) Mode

When properly configured with a GTN™, if an approach procedure is loaded, this switch also activates the missed approach when the selected navigation source is GPS or when the navigation source is VOR/LOC and a valid frequency has been tuned.

MET Switch (Manual Electric Trim)

Used to command manual electric trim for the pitch servo.

ENGAGING THE AUTOPILOT

An initial press of the **AP** Key on the GMC control unit will activate the Flight Director and engage the autopilot in the default PIT and ROL modes.

DISENGAGING THE AUTOPILOT



NOTE: When the autopilot is engaged with auto trim enabled, moving the MET Switch will disengage the AP.

The Autopilot is manually disengaged by pushing the autopilot disconnect button on the pilot's flight controls or by pressing the **AP** Key on the GMC control unit. Manual disengagement is indicated by a five-second flashing yellow 'AP' annunciation and an aural alert. Cancel the aural alert by pressing and releasing the **AP** Button again or by touching the 'AP' annunciation in the Autopilot Status Box at the top of the PFD.

Automatic disengagement is indicated by a flashing red 'AP' annunciation and an aural alert. Touch to acknowledge or touch **Back** to acknowledge. Automatic disengagement occurs due to:

- System failure
- Invalid sensor data
- Inability to compute default autopilot modes

DISENGAGING THE AUTOPILOT WHEN A MALFUNCTION IS SUSPECTED

If an autopilot failure or trim failure is suspected to have occurred, perform the following steps:

- 1) Firmly grasp the control wheel.
- 2) Press and hold the AP DISC Switch. The autopilot will disconnect and power is removed from the trim motor. Power is also removed from all primary servo motors and engaged solenoids. Note the visual and aural alerting indicating autopilot disconnect.
- 3) Retrim the aircraft as needed. Substantial trim adjustment may be needed.
- 4) Pull the appropriate Autopilot and Trim Switch (if installed) circuit breaker(s) to electrically isolate the servo and solenoid components.
- 5) Release the AP DISC Switch.

OVERPOWERING AUTOPILOT SERVOS

In the context of this discussion, "overpowering" refers to any pressure or force applied to the pitch controls when the autopilot is engaged. A small amount of pressure or force on the pitch controls can cause the autopilot automatic trim to run to an out-of-trim condition. Therefore, any application of pressure or force to the controls should be avoided when the autopilot is engaged.

Overpowering the autopilot during flight will cause the autopilot's automatic trim to run, resulting in an out-of-trim condition or cause the trim to hit the stop if the action is prolonged. In this case, larger than anticipated control forces are required after the autopilot is disengaged.

The following steps should be added to the preflight check:

- 1) Check for proper autopilot operation and ensure the autopilot can be overpowered.
- 2) Note the forces required to overpower the autopilot servo clutches.

FLIGHT DIRECTOR OPERATION

The flight director function provides pitch and roll commands to the pilot and autopilot, which are displayed on the PFD. With the flight director active, the aircraft can be hand-flown to follow the path shown by the Command Bars. The Flight Director has the following maximum commands: pitch (-15°, +20°) and roll (30°) angles.

FLIGHT DIRECTOR INDICATOR TYPE

The Flight Director Indicator Type controls whether the flight director command indicator on the PFD uses a single-cue or dual-cue presentation.

Setting the Flight Director Indicator Type:

- 1) From the PFD1, press the **MENU** Key twice to display the Main Menu.
- 2) Touch **Setup > Flight Director**.
- 3) In the Indicator Type field, touch **Single Cue** or **Dual Cue**.

ACTIVATING THE FLIGHT DIRECTOR USING THE GMC 507

An initial press of a key listed in the table below (when the flight director is not active) activates the flight director in the listed modes. The flight director may be turned off and the Command Bars removed from the display by pressing the **FD** Key again. The **FD** Key is disabled when the autopilot is engaged.

Control Pressed	Modes Selected			
	Lateral		Vertical	
FD Key	Roll Hold (default)	ROL	Pitch Hold (default)	PIT
AP Key	Roll Hold (default)	ROL	Pitch Hold (default)	PIT
TO/GA Button	Takeoff (on ground)Go Around (in air)	TO GA	Takeoff (on ground)Go Around (in air)	TO GA
ALT Key	Roll Hold (default)	ROL	Altitude Hold	ALT
VS Key	Roll Hold (default)	ROL	Vertical Speed	VS

Control Pressed	Modes Selected			
	Lateral		Vertical	
VNV Key	Roll Hold (default)	ROL	Vertical Navigation*	VNAV
IAS Key	Roll Hold (default)	ROL	Indicated Airspeed	IAS
APR Key	Approach**	GPS VOR LOC	Pitch Hold (default)	PIT
NAV Key	Navigation**	GPS VOR LOC BC	Pitch Hold (default)	PIT
HDG Key	Heading Select	HDG	Pitch Hold (default)	PIT
TRK Key	Track Select	TRK	Pitch Hold (default)	PIT
LVL Key	Level Hold	LVL	Level Hold	LVL

*Valid VNV flight plan must be entered before VNV Key press activates flight director.

**The selected navigation receiver must have a valid VOR or LOC signal or active GPS course before NAV or APR Key press activates flight director.

Flight Director Activation (GMC 507)

FLIGHT DIRECTOR MODES

Flight director modes are normally selected independently for the pitch and roll axes. Unless otherwise specified, all mode keys are alternate action (i.e., press on, press off). In the absence of specific mode selection, the flight director reverts to the default pitch and/or roll modes.

Armed modes are annunciated in white and active in green in the AFCS Status Box. Under normal operation, when the control for the active flight director mode is pressed, the flight director reverts to the default mode(s) for the axis(es). Automatic transition from armed to active mode is indicated by the white armed mode annunciation moving to the green active mode field and flashing for 10 seconds.

If the information required to compute a flight director mode becomes invalid or unavailable, the flight director automatically reverts to the default mode for that axis. A flashing yellow mode annunciation and annunciator light indicate loss of sensor (ADC) or navigation data (VOR, LOC, GPS, VNAV) required to compute commands. When such a loss occurs, the system automatically begins to roll the wings level (enters Roll Hold Mode) or maintain the pitch angle (enters Pitch Hold Mode), depending on the affected axis. The flashing annunciation stops when the affected mode key is pressed or another mode for the axis is selected. If after 10 seconds no action is taken, the flashing annunciation stops.

The flight director is automatically disabled if the attitude information required to compute the default flight director modes becomes invalid or unavailable.



Autopilot Manually Disengaged

COMMAND BARS

SINGLE CUE

Upon activation of the flight director, Command Bars are displayed in magenta on the PFD. If the aircraft is being flown by hand, the command bars are displayed hollow. The Command Bars do not override the Aircraft Symbol. The Command Bars move together vertically to indicate pitch commands and bank left or right to indicate roll commands.

- System Overview
- Flight Instruments
- EIS
- CNS Interface
- GPS Navigation
- Flight Planning
- Hazard Avoidance
- Additional Features
- AFCS
- Annun/Alerts
- Appendix
- Index

Hollow Single Cue Command Bars (Pilot Hand Flying Aircraft, FD Only)

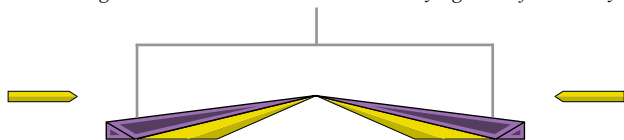

Solid Single Cue Command Bars (Autopilot Engaged)

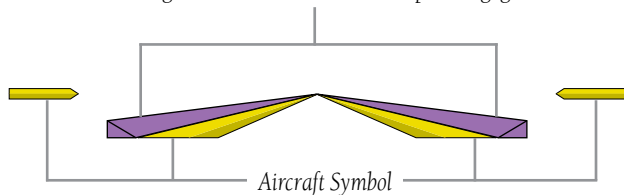

Command Bars (Single Cue)

DUAL CUE

The Dual Cue Command Bars are useful to visually separate pitch from roll when flying the aircraft by hand.

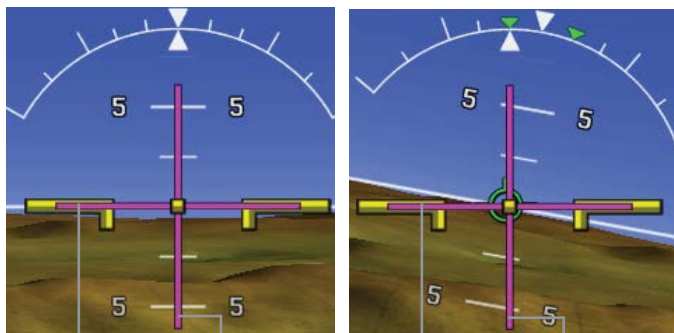

Dual Cue Command Bars

Dual Cue Command Bars

Command Bars (Dual Cue)

If the attitude information being sent to the flight director becomes invalid or unavailable, the Command Bars are removed from the display.

9.2 VERTICAL MODES

The table lists the vertical modes with their corresponding controls and annunciations. The mode reference is displayed next to the active mode annunciation for Altitude Hold, Vertical Speed, and Indicated Airspeed modes. The **NOSE UP/DN** Wheel (GMC control unit) or the on-screen **VS MODE** can be used to change the vertical mode reference while operating under Pitch Hold, Vertical Speed, Indicated Airspeed, or Altitude Hold modes. Increments of change of values for each of these references using the **NOSE UP/DN** Wheel, are also listed in the table.

Vertical Mode	Description	Control	Annunciation	Reference Change Increment
Pitch Hold	Holds the current aircraft pitch attitude; may be used to climb/descend to the Selected Altitude	(default)	PIT	0.5°
Selected Altitude Capture	Captures the Selected Altitude	*	ALTS	10 ft
Altitude Hold	Holds the current Altitude	ALT Key (GMC 507) or ALT G3X Touch	ALT nnnnn FT	
Vertical Speed	Maintains the current aircraft vertical speed; may be used to climb/descend to the Selected Altitude	VS Key (GMC 507) or VS G3X Touch	VS nnnn FPM	100 fpm
Indicated Airspeed (IAS)	Maintains the current aircraft airspeed in IAS while the aircraft is climbing/descending to the Selected Altitude	IAS Key	IAS nnn KT	1 kt

Vertical Mode	Description	Control	Annunciation	Reference Change Increment
Vertical Navigation	Captures and tracks descent legs of an active vertical profile	VNAV G3X Touch/ GMC 507	VNAV	
VNV Target Altitude Capture	Captures the Vertical Navigation (VNV) Target Altitude	**	ALTV	
Glidepath	Captures and tracks the SBAS glidepath on approach	APR Key (GMC 507) or APPR G3X Touch	GP	
Glideslope	Captures and tracks the ILS glideslope on approach		GS	
Takeoff	Commands a constant pitch angle and wings level on ground in preparation for takeoff	TO/GA Button	TO	
Go Around	Commands a constant pitch angle and wings level in the air		GA	

* *ALTS armed automatically when PIT, VS, IAS, or GA active, and under VNAV when Selected Altitude is to be captured instead of VNV Target Altitude*

** *ALTV armed automatically under VNAV when VNV Target Altitude is to be captured instead of Selected Altitude*

Flight Director Vertical Modes

PITCH HOLD MODE (PIT)

When the flight director is activated (**FD** touched) or when the Autopilot is activated, Pitch Hold Mode is selected by default. Pitch Hold Mode is indicated as the active vertical mode by the green 'PIT' annunciation. This mode may be used for climb or descent to the Selected Altitude (shown above the Altimeter), since Selected Altitude Capture Mode is automatically armed when Pitch Hold Mode is activated.

In Pitch Hold Mode, the flight director maintains a constant pitch attitude. The pitch reference is set to the aircraft pitch attitude at the moment of mode selection. If the aircraft pitch attitude exceeds the flight director pitch command limitations, the flight director commands a pitch angle equal to the nose-up/down limit.

CHANGING THE PITCH REFERENCE:

When operating in Pitch Hold Mode, the pitch reference can be adjusted by using the **NOSE UP/DN** Wheel (GMC control unit) or by touching **Nose Up** or **Nose Down** on the G3X Touch.



Pitch Hold & Selected Altitude Capture Modes

SELECTED ALTITUDE CAPTURE MODE (ALTS)

Selected Altitude Capture Mode is automatically armed with activation of the following modes:

- Pitch Hold
- Vertical Speed
- Indicated Airspeed
- TO/GA (GMC control unit)
- Vertical Path Tracking (if the Selected Altitude is to be captured instead of the VNV Target Altitude)

The white 'ALTS' annunciation indicates Selected Altitude Capture Mode is armed. Touch the autopilot on the PFD and touch **ALT**. Use the large knob associated with the PFD and adjust the Selected Altitude until the Selected Altitude Capture Mode becomes active.

AP | ROL | VS ALTS

As the aircraft nears the Selected Altitude, the flight director automatically transitions to Selected Altitude Capture Mode with Altitude Hold Mode armed. This automatic transition is indicated by the green 'ALTS' annunciation flashing for up to 10 seconds and the appearance of the white 'ALTS' annunciation. The Selected Altitude is shown as the Altitude Reference beside the 'ALTS' annunciation.

*Automatic transition to ALTS
Mode with ALT Mode armed*

AP | ROL | **ALTS** ALT

At 50 feet from the Selected Altitude, the flight director automatically transitions from Selected Altitude Capture to Altitude Hold Mode and holds the reference altitude. As Altitude Hold Mode becomes active, the white 'ALTS' annunciation moves to the active vertical mode field and flashes green for 10 seconds to indicate the automatic transition.

*Automatic transition to ALTS
Mode with ALT Mode armed*

AP | ROL | **ALTS** ALT

Setting the selected altitude (Integrated Autopilot Interface):

Touch the Autopilot Status Box, and use the **Altitude** knob on the **PFD** to select the desired Selected Altitude.

Or:

Touch the Selected Altitude on the PFD, and use the keypad to enter the desired Selected Altitude.

Setting the selected altitude (GMC 507):

Press the **AP** key, and use the **ALT SEL Knob**.

Or:

Touch the Selected Altitude on the PFD, and use the keypad to enter the desired Selected Altitude.

Changing the Selected Altitude while Selected Altitude Capture Mode is active causes the autopilot to revert to Pitch Hold Mode with Selected Altitude Capture Mode armed for the new Selected Altitude.

ALTITUDE HOLD MODE (ALT)

Altitude Hold Mode can be activated by touching **ALT** or **ALT** Key (GMC control unit); the AFCS maintains the current aircraft altitude (to the nearest 10 feet) as the Altitude Reference. The Altitude Reference, shown in the G3X Touch Autopilot Status Box, is independent of the Selected Altitude, displayed above the Altimeter. Altitude Hold Mode active is indicated by a green 'ALT' annunciation in the G3X Touch Autopilot Status Box.

Altitude Hold Mode is automatically armed when in Selected Altitude Capture Mode. Selected Altitude Capture Mode automatically transitions to Altitude Hold Mode when within 50 feet of the Selected Altitude. In this case, the Selected Altitude becomes the Altitude Reference.

CHANGING THE ALTITUDE REFERENCE

When operating in Altitude Hold Mode, the Altitude Reference can be adjusted in the following ways:

- The Altitude Reference can be adjusted up or down in 10-foot increments by **Higher Alt** or **Lower Alt** or rolling the **NOSE UP/DN** Wheel (GMC control unit). Using this method, up to 200 feet of altitude change can be commanded. To change the Altitude Reference by more the 200 feet, climb/descend using another vertical mode (PIT, VS) to capture the desired Selected Altitude.

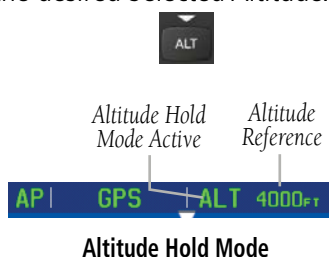

VERTICAL SPEED MODE (VS)

In Vertical Speed Mode, the flight director acquires and maintains a Vertical Speed Reference. Current aircraft vertical speed (to the nearest 100 fpm) becomes the Vertical Speed Reference at the moment of Vertical Speed Mode activation. This mode may be used for climb or descent to the Selected Altitude (shown above the Altimeter) since Selected Altitude Capture Mode is automatically armed when Vertical Speed Mode is selected.

When Vertical Speed Mode is activated by pressing the **VS** Key (GMC control unit) or touching **VS**, 'VS' is annunciated in green in the Autopilot Status Box along with the Vertical Speed Reference. The Vertical Speed Reference is also displayed above the Vertical Speed Indicator. A Vertical Speed Reference Bug corresponding to the Vertical Speed Reference is shown on the indicator.

CHANGING THE VERTICAL SPEED REFERENCE

The Vertical Speed Reference may be adjusted in the following ways:

- Use the **NOSE UP/DN** Wheel (GMC control unit) or touch the autopilot, touch **VS**, and touch **Nose Up** or **Nose Down** to adjust the Vertical Speed Reference in increments of 100 fpm. The current Vertical Speed Reference is displayed in the G3X Touch Autopilot Status Box for 10 seconds after a change is made and as a reference bug on the Vertical Speed Indicator.

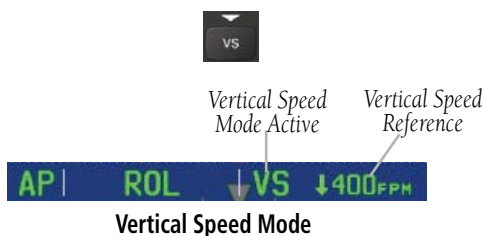

INDICATED AIRSPEED MODE (IAS)

Indicated Airspeed Mode is selected by touching **IAS** on the **PFD** and selecting either **Faster** or **Slower**, or by pressing the **IAS** button on the GMC control unit and adjusting the **Nose UP/DN** Wheel. This mode acquires and maintains the Airspeed Reference (IAS) while climbing or descending. When Indicated Airspeed Mode is active, the flight director continuously monitors Selected Altitude, airspeed and altitude.

The Airspeed Reference is set to the current airspeed upon mode activation. Indicated Airspeed Mode is indicated by a green 'IAS' annunciation beside the Airspeed Reference in the Autopilot Status Box. The Airspeed Reference is also displayed as a cyan bug corresponding to the Airspeed Reference along the airspeed tape.

Engine power must be adjusted to allow the autopilot to fly the aircraft at a pitch attitude corresponding to the desired flight profile (climb or descent) while maintaining the Airspeed Reference.



NOTE: If IAS Mode is selected while aircraft is stopped on ground, airspeed is set to V_y .

CHANGING THE AIRSPEED REFERENCE

The Airspeed Reference (shown in both the Autopilot Status Box and above the Airspeed Indicator) may be adjusted by using the **NOSE UP/DN** Wheel or by touching **Nose Up** or **Nose Down** in the AFCS Window.

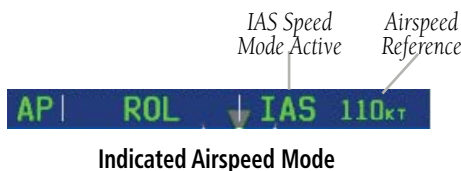

VERTICAL NAVIGATION MODE (VNAV)



NOTE: If another vertical mode is touched while VNAV Mode is selected, VNAV Mode reverts to armed.



NOTE: VNAV mode will not capture a descending profile unless the selected altitude is valid and at least 75 feet below the current aircraft altitude.

Vertical Navigation (VNAV) Mode is available for enroute/terminal cruise and descent operations any time that VNAV flight planning is available. Refer to Section 2.3 (Vertical Navigation) for more information.

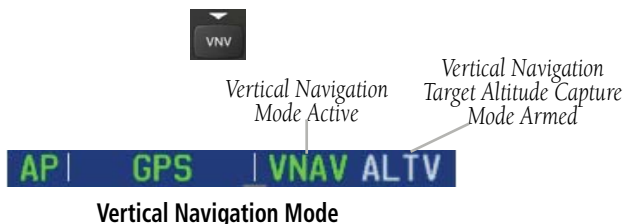

Activating Vertical Navigation Mode:

- 1 When a flight plan is active, VNAV data is valid, and the **VNAV** Key is selected on the GMC 507 or G3X Touch, VNAV mode is armed in preparation for descent path capture. 'VNAV' is annunciated in white in the G3X Touch Autopilot Status Box. If applicable, the appropriate altitude capture mode is armed for capture of the VNAV Target Altitude (ALTV) or the Selected Altitude (ALTS), whichever is greater.
- 2 When a descent leg is captured (i.e., vertical deviation becomes valid), VNAV Mode is activated and tracks the descent profile. An altitude capture mode (ALTS or ALTV) is armed as appropriate.
- 3 When approaching the VNAV Target Altitude (or Selected Altitude) the system automatically transitions to ALTS or ALTV Mode with ALT Mode armed.

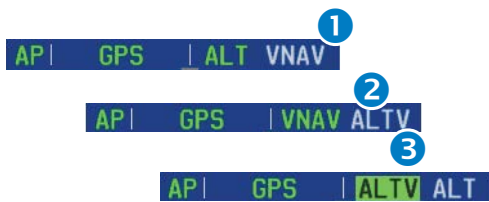

If the altimeter's barometric setting is adjusted while VNAV mode is active, the autopilot increases/decreases the descent rate by up to 500 fpm to re-establish the aircraft on the descent path (without commanding a climb). For large changes, it may take several minutes for the aircraft to reestablish on the descent path. If the change is made while nearing the VNAV waypoint, the aircraft may not reestablish on the descent path in time to level off at the VNAV Target Altitude. In this case, the autopilot will revert to Pitch Hold mode upon passing the VNAV waypoint, and Selected Altitude Capture (ALTV) mode will be automatically armed.

AUTOMATIC REVERSION TO PITCH HOLD MODE

Several situations can occur while VNAV Mode is active which cause the AFCS to revert to Pitch Hold Mode:

- Vertical deviation exceeds 200 feet during an overspeed condition.
- Vertical deviation becomes invalid (the Deviation Indicator is removed from the PFD).

Following a reversion to Pitch Hold Mode, VNAV Mode and the appropriate altitude capture mode become armed to allow for possible profile recapture.

VNAV TARGET ALTITUDE CAPTURE MODE (ALTV)

VNAV Target Altitude Capture is analogous to Selected Altitude Capture Mode and is armed automatically after the **VNV** Key (GMC 305) or **VNAV** (GMC 307/507) is selected if the VNAV Target Altitude is to be intercepted before the Selected Altitude. The annunciation 'ALTV' indicates the VNAV Target Altitude is to be captured. Refer to Section 2.3 (Vertical Navigation) for more information on setting up the VNAV target altitude.

As the aircraft nears the VNAV Target Altitude, AFCS automatically transitions to VNAV Target Altitude Capture Mode with Altitude Hold Mode armed. This automatic transition is indicated by the green 'ALTV' annunciation flashing for up to 10 seconds and the appearance of the white 'ALT' annunciation.

At 50 feet from the VNAV Target Altitude, the AFCS automatically transitions from VNAV Target Altitude Capture to Altitude Hold Mode and selects the VNAV target altitude as the new Autopilot Altitude Reference. As Altitude Hold Mode becomes active, the white 'ALT' annunciation moves to the active vertical mode field and flashes green for 10 seconds to indicate the automatic transition.

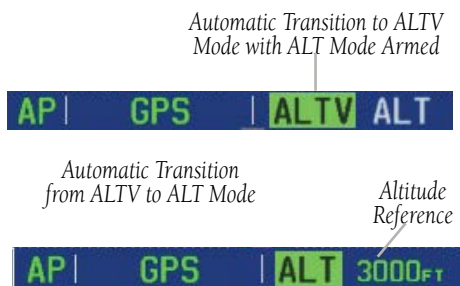

Automatic Mode Transitions During Altitude Capture

GLIDEPATH MODE (GP) (WITH EXTERNAL WAAS ENABLED IFR NAVIGATOR ONLY)

Glidepath Mode is used to track a WAAS or other satellite-based augmentation system SBAS generated glidepath. When Glidepath Mode is armed, 'GP' is annunciated in white in the Autopilot Status Box.

Selecting Glidepath Mode:

- 1) **EXTERNAL NAVIGATOR:** Ensure a GPS approach with vertical guidance (LPV, LP+V, LNAV/VNAV, LNAV +V) is loaded into the active flight plan. The active waypoint must be part of the flight plan (cannot be a direct-to a waypoint not in the flight plan).
- 2) Ensure that GPS is the selected navigation source.
- 3) Press the **APR** Key (GMC control unit) or touch the autopilot, then touch **APPR** (only available when an external GPS navigation source (i.e., GTN or GNS Series) is configured).



NOTE: Some RNAV (GPS) approaches provide a vertical descent angle as an aid in flying a stabilized approach. These approaches are NOT considered Approaches with Vertical Guidance (APV). Approaches that are annunciated on the HSI as LNAV or LNAV+V are considered Nonprecision Approaches (NPA) and are flown to an MDA even though vertical glidepath (GP) information may be provided.



WARNING: When flying an LNAV approach (with vertical descent angle) with the autopilot coupled, the aircraft will not level off at the MDA even if the MDA is set in the altitude preselect.

Upon reaching the glidepath, the flight director transitions to Glidepath Mode and begins to capture and track the glidepath.

Once the following conditions have been met, the glidepath can be captured:

- The active waypoint is at or after the final approach fix (FAF).
- Vertical deviation is valid.

- The CDI is at less than full-scale deviation.
- Automatic sequencing of waypoints has not been suspended (no 'SUSP' annunciation on the HSI).

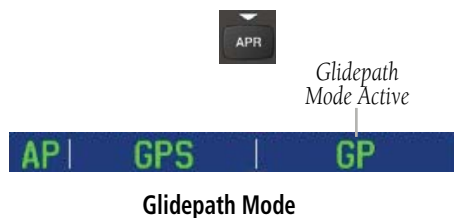

GLIDESLOPE MODE (GS)



NOTE: *Glideslope Mode requires a valid GPS position.*

Glideslope Mode is available for LOC/ILS approaches to capture and track the glideslope. When Glideslope Mode is armed (annunciated as 'GS' in white), LOC Approach Mode is armed as the lateral flight director mode.

Selecting Glideslope Mode:

- 1) EXTERNAL NAVIGATOR: Tune and activate the desired localizer frequency.
- 2) EXTERNAL NAVIGATOR: Ensure that LOC is the selected navigation source.
- 3) Press the **APR** Key (GMC control unit) or touch the autopilot and touch **APPR**. This simultaneously selects LOC and GS (Glideslope) Modes.

Or:

- 1) EXTERNAL NAVIGATOR: Tune and activate the desired localizer frequency.
- 2) EXTERNAL NAVIGATOR: Load the approach (LOC, ILS, LDA, SDF, etc.) into the flight plan.
- 3) Press the **APR** Key (GMC control unit) or touch the autopilot and touch **APPR**. This simultaneously selects LOC and GS (Glideslope) Modes.

Once LOC is the navigation source, the localizer and glideslope can be captured. Upon reaching the glideslope, the flight director transitions to Glideslope Mode and begins to capture and track the glideslope.



Glideslope Mode Armed

GO AROUND (GA) AND TAKEOFF (TO) MODES

Go Around and Takeoff modes are coupled pitch and roll modes and are annunciated as both the vertical and lateral modes when active. In these modes, the flight director commands a constant set pitch attitude and keeps the wings level. The GA Switch is used to activate both modes. The mode entered by the flight director depends on whether the aircraft is on the ground or in the air.

Takeoff Mode provides an attitude reference during rotation and takeoff. This mode can be selected only while on the ground by pushing the **TO/GA** Button. The flight director Command Bars assume a wings-level, pitch-up attitude.

Pressing the **TO/GA** Button while in the air activates the flight director in a wings-level, pitch-up attitude, allowing the execution of a missed approach or a go around.

9.3 LATERAL MODES

The following table lists the lateral modes and respective control(s) and annunciation. Refer to the vertical modes section for information regarding Takeoff and Go Around Modes.

Lateral Mode	Description	Control	Annunciation
Roll Hold	Holds the current aircraft roll attitude or rolls the wings level, depending on the commanded bank angle	(default)	ROL
Heading Select	Captures and tracks the Selected Heading	HDG Key (GMC 507) or HDG	HDG
Track	Captures and tracks the Selected Ground Track	TRK Key (GMC 507) or TRK	TRK

	Lateral Mode	Description	Control	Annunciation
System Overview	Navigation, GPS	Captures and tracks the selected navigation source (GPS, VOR, LOC)	NAV Key (GMC 507) or NAV	GPS
Flight Instruments	Navigation, VOR Enroute Capture/Track			VOR
EIS	Navigation, LOC Capture/Track (No Glideslope)			LOC
CNS Interface	Navigation, Backcourse Capture/Track			BC
GPS Navigation	Approach, GPS	Captures and tracks the selected navigation source (GPS and LOC)	APR Key (GMC 507) or APPR	GPS
Flight Planning	Approach, LOC Capture/Track (Glideslope Mode automatically armed)			LOC
Hazard Avoidance	Takeoff	Commands a constant pitch angle and wings level on ground in preparation for takeoff	TO/GA Button	TO
Additional Features	Go Around	Commands a constant pitch angle and wings level in the air		GA

The AFCS limits the turn rate to a standard rate turn (3 degs/sec) except in cases when the AFCS is following an external navigator providing GPS (bank angle) steering. In this case the turn rate is limited by the flight director maximum bank angle configuration setting.

Flight Director Lateral Modes

ROLL HOLD MODE (ROL)



NOTE: If Roll Hold Mode is activated as a result of a mode reversion, the flight director rolls the wings level.

When the flight director is activated or switched, Roll Hold Mode is selected by default. This mode is annunciated as 'ROL' in the Autopilot Status Box. The current aircraft bank angle is held, subject to the bank angle condition.



Roll Hold Mode Annunciation

Bank Angle	Flight Director Response
< 6°	Rolls wings level
6 to 20°	Maintains current aircraft roll attitude
>20°	Limits bank to 20°

Roll Hold Mode Responses

CHANGING THE ROLL REFERENCE

When operating in Roll Hold Mode, the roll reference can be adjusted in the following ways:

- To decrease the roll reference, turn the inner knob associated with the PFD right. The AFCS slowly decreases the bank angle. The current bank angle is held (if the bank angle exceeds 6°). If the bank angle is less than 6°, the AFCS will roll the aircraft wings level.

HEADING SELECT MODE (HDG)

Heading Select Mode is activated by touching the autopilot, then touching **HDG** or the **HDG** Key (GMC control unit). Heading Select Mode acquires and maintains the Selected Heading. The Selected Heading is shown by a cyan bug on the HSI and in the box to the upper left of the HSI.

CHANGING THE SELECTED HEADING

Changing the selected heading (Integrated Autopilot Interface):

- 1) Touch the Selected Heading on the PFD.
- 2) Enter the selected heading using the keypad and touch **Enter**.

Changing the selected heading (GMC 507):

- 1) Turn the **HDG Knob** to select the desired heading.
- 2) Press the **HDG** Key on the GMC control unit to activate HDG Mode.

Turns are commanded in the same direction as Selected Heading Bug movement, even if the Bug is turned more than 180° from the present heading (e.g., a 270° turn to the right). However, Selected Heading changes of more than 330° at a time result in turn reversals.



Heading Mode Annunciation

TRACK SELECT MODE (TRK)

The Track Select Mode is activated by touching the autopilot, then touching **TRK** on the **PFD** or pressing the **TRK** Key . Track Mode acquires and maintains the Selected Ground Track.

Changing the selected track:

- 1) Use the **HDG/TRK Knob** to select the desired ground track.

Or:

Touch the Selected Track on the PFD, Enter the selected track using the keypad and touch **Enter**.

- 2) Select **TRK** to activate TRK Mode.



Track Mode Annunciation

NAVIGATION MODES (GPS, VOR, LOC, BC)



NOTE: When making a VOR or LOC approach, a valid GPS position is required.



NOTE: The selected navigation receiver must have a valid VOR or LOC signal or active GPS course for the flight director to enter Navigation Mode.



NOTE: When intercepting a flight plan leg, the flight director gives commands to capture the active leg at approximately a 45° angle to the track between the waypoints defining the active leg. The flight director does not give commands fly to the starting waypoint of the active leg.



NOTE: When making a backcourse approach, set the Selected Course to the localizer front course.

Pressing the **NAV** Key or touching **NAV** on the G3X Touch selects Navigation Mode. Navigation Mode acquires and tracks the selected navigation source (GPS, VOR, LOC). The flight director follows GPS roll steering commands when GPS is the selected navigation source. When the navigation source is VOR or LOC, the flight director creates roll steering commands from the Selected Course and deviation. Navigation Mode can also be used to fly non-precision GPS and LOC approaches where vertical guidance is not required.

Backcourse Navigation Mode captures and tracks a localizer signal in the backcourse direction. The annunciation 'BC' in the Autopilot Status Box indicates Backcourse Navigation Mode.

If the Course Deviation Indicator (CDI) shows greater than one dot when the **NAV** Key is pressed or **NAV** is touched, the selected mode is armed. If the CDI is less than one dot, Navigation Mode is automatically captured when the **NAV** Key is pressed or **NAV** is touched. The armed annunciation appears in white to the left of the active roll mode.



Navigation Mode Annunciation

When the CDI has automatically switched from GPS to LOC during a LOC/ILS approach, GPS Navigation Mode remains active, providing GPS steering guidance until the localizer signal is captured. LOC Navigation Mode is armed when the automatic navigation source switch takes place. If the **APR** Key is pressed or **NAV** is touched prior to the automatic navigation source switch, LOC Navigation Mode is armed.

If Navigation Mode is active and either of the following occur, the flight director reverts to Roll Hold Mode (wings rolled level):

- Different VOR tuned while in VOR Navigation Mode (VOR Navigation Mode reverts to armed)
- Navigation source manually switched
- During a LOC/ILS approach, the FAF is crossed while in GPS Navigation Mode after the automatic navigation source switch from GPS to LOC

LOC Mode is activated when the automatic navigation source switch takes place. If the **APR** Key is pressed or **APPR** is touched prior to the automatic navigation source switch, LOC Mode is armed.

In the right circumstances, LOC and GS Modes can be armed while GPS Mode is still active and the external navigator (GTN X50, GTN X50 Xi, or GNS X30 WAAS only) is set to GPS (not VLOC).

Arming LOC & GS Modes while GPS Mode is still active:

- 1) EXTERNAL NAVIGATOR: Tune and activate the desired localizer frequency.
- 2) EXTERNAL NAVIGATOR: Load the approach (LOC, ILS, LDA, SDF, etc.) into the flight plan.
- 3) G3X Touch: While GPS is still the selected navigation source on the external navigator, press the **APR** Key (GMC control unit) or touch **APPR** to arm LOC and GS (Glideslope) Modes even with GPS Mode still active. The external navigator will switch from GPS to VLOC automatically and the G3X Touch will capture the localizer and then the glideslope.

If Navigation Mode is active and either of the following occur, the AFCS reverts to Roll Hold Mode (wings rolled level):

- Different VOR tuned while in VOR Navigation Mode (VOR Navigation Mode reverts to armed)
- Active navigation source manually switched
- Active flight plan is deleted (only GPS-based modes)
- GPS reception is lost

If VOR Navigation Mode is active and the VOR signal is lost, the autopilot reverts to Roll Hold Mode (wings rolled level) and reverts VOR Mode to armed in the event the VOR signal is reestablished.

OBS MODE

Enabling/disabling OBS Mode (without external GPS navigator):

- 1) While navigating a flight plan or Direct-to, touch **CRS** on the PFD.
- 2) Touch **Yes** on the 'Set OBS and hold?' window.
- 3) Enter the desired course to/from the waypoint using the keypad and touch **Enter**.
- 4) To cancel OBS Mode and return to automatic waypoint sequencing, touch **OBS** on the PFD.
- 5) Touch **Release OBS Hold**.

Or:

- 1) From the Active Flight Plan Page press the **MENU** Key while navigating a flight plan or Direct-to.
- 2) Touch **Set OBS and Hold**.
- 3) Touch **Sync Course** or enter the desired course to/from the waypoint using the keypad and touch **Enter**.
- 4) To cancel OBS Mode and return to automatic waypoint sequencing, press the **MENU** Key.
- 5) Touch **Release Hold**.

Enabling/disabling OBS Mode (with external GPS navigator configured):

- 1) Press the **OBS** Key on the external navigator. The 'Set OBS and Hold' Active Flight Plan Page menu option is now available.
- 2) From the Active Flight Plan Page press the **MENU** Key while navigating a flight plan or Direct-to.
- 3) Touch **Set OBS and Hold**.
- 4) Touch **Sync Course** or enter the desired course to/from the waypoint using the keypad and touch **Enter**.
- 5) To cancel OBS Mode and return to automatic waypoint sequencing, press the **MENU** Key.
- 6) Touch **Release Hold**.

VOR MODE FOR NAVIGATION

VOR Mode can be used for navigation when an external navigation receiver is configured.

Tracking Direct-to a VOR:

- 1) EXTERNAL NAVIGATOR: Tune and activate the desired VOR frequency. If a GTN or GNS series unit is not configured skip to Step 3.
- 2) EXTERNAL NAVIGATOR (GTN or GNS series units only): Ensure the 'VLOC' indication is showing in the lower-left corner. If not, press the CDI Key.
- 3) G3X Touch: Ensure that VOR1 or VOR2 is the selected navigation source. It should say 'VOR1' or 'VOR2' on the HSI and the needle should be green.
- 4) G3X Touch: From the PFD, touch the course on the PFD and touch **Sync Course**.
- 5) G3X Touch: Touch the autopilot on the PFD, then touch **NAV** to activate VOR Mode.

Or:

Press the **NAV** Key on the GMC control unit.

A green 'VOR' indication is displayed in the autopilot status bar and the flight director tracks the selected course to the VOR.

Intercepting and tracking a VOR radial:

- 1) EXTERNAL NAVIGATOR: Tune and activate the desired VOR frequency. If a GTN or GNS series unit is not configured skip to Step 3.
- 2) EXTERNAL NAVIGATOR (GTN or GNS series units only): Ensure the 'VLOC' indication is showing in the lower-left corner of the. If not, press the CDI Key.
- 3) G3X Touch: Ensure that VOR1 or VOR2 is the selected navigation source. It should say 'VOR1' or 'VOR2' on the HSI and the needle should be green.
- 4) G3X Touch: From the PFD, touch the course on the PFD and touch **Sync Course**.
- 5) G3X Touch: From the PFD, touch the autopilot and touch **NAV**.

Or:

Press the **NAV** Key on the GMC control unit.

If there is less than half-scale deviation when **NAV** is touched or the **NAV** Key is pressed, VOR Mode will activate (green text), intercept, and track the selected radial. If there is more than half-scale deviation when **NAV** is touched, VOR Mode will arm (white text) first, then activate when closer to the radial.

APPROACHES WITHOUT VERTICAL GUIDANCE



NOTE: The selected navigation receiver must have a valid VOR or LOC signal or active GPS course for the flight director to enter Approach Mode.



NOTE: For the autopilot to enter a VLOC mode, the G3X Touch must have GPS reception, a valid navigation database, and the external navigation receiver must have a valid signal (VOR or LOC).

Touch **NAV** or press the **NAV** Key (GMC control unit) to arm/activate VOR, LOC/BC, and GPS (LNAV only) lateral modes. Lateral modes acquire and track the selected navigation source (GPS, VOR, or LOC), depending on the loaded approach. These modes use the selected navigation receiver deviation and desired course inputs to fly the approach. Touch **NAV** when the CDI is greater than one dot to arm the selected modes (annunciated in white). Touch **NAV** when the CDI deviation is less than one dot to activate, capture and track the selected navigation source (GPS, VOR, or LOC).

Example	Control	Lateral Mode	Annunciation	Description
LNAV	NAV Key (GMC 507) or NAV	Approach, GPS	GPS	Captures and tracks the selected navigation source (GPS, VOR, LOC)
VOR		VOR Approach Capture/Track	VOR	
LOC		LOC Capture/Track (No Glideslope)	LOC	
BC		Backcourse Capture/Track	BC	Captures and tracks a localizer signal for backcourse approaches

Approaches without Vertical Guidance

GPS APPROACH WITHOUT VERTICAL GUIDANCE

A GPS approach without vertical guidance (LNAV) is flown using GPS NAV Mode.

Selecting a GPS Approach without vertical guidance:

- 1) EXTERNAL NAVIGATOR: Ensure a GPS approach without vertical guidance (LNAV) is loaded into the active flight plan.
 - 2) EXTERNAL NAVIGATOR: Ensure the 'GPS' indication is showing in the lower-left corner. If not, press the CDI Key.
 - 3) G3X Touch: Ensure that GPS1 is the selected navigation source on the PFD.
 - 4) EXTERNAL NAVIGATOR: Select and activate the GPS approach using the PROC Key.
 - 5) G3X Touch: From the PFD touch the autopilot and touch **NAV** to activate GPS Mode.
- Or:**
- Press the **NAV** Key on the GMC control unit.
- 6) Adjust the aircraft's pitch axis as required.

VOR APPROACH

A VOR approach is flown using VOR Mode.

Selecting a VOR Approach:

- 1) EXTERNAL NAVIGATOR: Tune and activate the desired VOR frequency. If a GTN or GNS series unit is not configured skip to Step 3.
- 2) EXTERNAL NAVIGATOR (GTN or GNS series units only): Ensure the 'VLOC' indication is showing in the lower-left corner of the. If not, press the CDI Key.
- 3) G3X Touch: Ensure that VOR1 or VOR2 is the selected navigation source. It should say 'VOR1' or 'VOR2' on the HSI and the needle should be green.
- 4) G3X Touch: From the PFD touch the autopilot and touch **CRS**. Select the inbound approach course (radial).
- 5) G3X Touch: From the PFD, touch the autopilot and touch **NAV**.

Or:

Press the **NAV** Key on the GMC control unit.

If there is less than half-scale deviation when touching **NAV** or when the **NAV** Key is pressed, VOR Mode will activate (green text), intercept, and track the selected radial. If there is more than half-scale deviation when **NAV** is touched or when the **NAV** Key is pressed, VOR Mode will arm (white text) first, then activate when closer to the radial.

- 6) Adjust the aircraft's pitch axis as required.

LOCALIZER APPROACH (NO GS)

LOC Mode is used to fly a localizer only approach (no glideslope).

Selecting LOC Mode for a localizer only approach:

- 1) EXTERNAL NAVIGATOR: Tune and activate the desired LOC frequency,
- 2) G3X Touch: Ensure that LOC1 is the selected navigation source. The HSI should automatically slew the needle to the correct course.
- 3) G3X Touch: From the PFD, touch the autopilot and touch **NAV** to activate LOC Mode.

Or: Press or the **NAV** Key on the GMC control unit.

If the localizer deviation is less than half-scale when **NAV** is touched or when the **NAV** Key is pressed, the autopilot will activate LOC Mode and track the localizer, otherwise LOC Mode is armed and the pilot is responsible for intercepting the localizer. In some cases it may be necessary to use HDG Mode with LOC Mode armed to follow a vector to the localizer.

BACKCOURSE APPROACH



NOTE: When making a backcourse approach, set the Selected Course to the localizer front course.



NOTE: 'BC' will not be displayed on the G3X Touch HSI.

Backcourse Mode captures and tracks a localizer signal in the backcourse direction. Backcourse is indicated by 'BC' in the autopilot status box.

If GS and LOC Mode are armed, the flight director can only capture the localizer front course, indicated by 'LOC' in the autopilot status box. If only LOC Mode is armed (not GS Mode), the flight director will capture either the front course or the backcourse based on the angle at which the aircraft intercepts the localizer.

Selecting BC Mode:

- 1) EXTERNAL NAVIGATOR: Tune and activate the desired LOC frequency.
- 2) G3X Touch: Ensure that LOC1 is the selected navigation source. The HSI should automatically slew the needle to the correct course.
- 3) G3X Touch: From the PFD touch the autopilot then touch **NAV**.

Or:

Press the **NAV** Key on the GMC control unit.

If the aircraft heading is within 75° of the localizer backcourse then BC Mode will be armed. If the aircraft heading is within 105° of the localizer front course, LOC Mode will be armed.

APPROACHES WITH LATERAL + VERTICAL GUIDANCE

Touch **APPR** or press the **APR** Key (GMC control unit) to arm/activate both lateral and vertical modes for approach. When Glidepath (GP) Mode is armed for a GPS approach with vertical guidance, GPS Mode is automatically armed. When Glideslope (GS) Mode is armed for an ILS approach, LOC Mode is automatically armed. Touch **APPR** or press the **APR** Key (GMC control unit) when the CDI is greater than one dot to arm the selected modes (annunciated in white). Touch **APPR** or press the **APR** Key (GMC control unit) when the CDI deviation is less than one dot to activate, capture and track the selected navigation source.

Example	Control	Modes	Annunciation	Description
LPV, LP+V, LNAV/VNAV, LNAV+V	APR Key (GMC 507) or APPR	Lateral: GPS	GPS	Captures and tracks the lateral portion of a GPS approach
		Vertical: Glidepath	GP	Captures and tracks a WAAS approach glidepath
LOC, ILS, LDA, SDF	APR Key (GMC 507) or APPR	Lateral: Localizer	LOC	Captures and tracks the localizer
		Vertical: Glideslope	GS	Captures and tracks the glideslope

Lateral + Vertical Approaches

GPS APPROACH WITH VERTICAL GUIDANCE



NOTE: To cancel Glidepath (GP) Mode without canceling GPS Mode, **NAV** once. Pressing it a second time cancels GPS Mode.

When Glidepath (GP) Mode is armed for a GPS approach with vertical guidance, GPS Mode is automatically armed.

Selecting a GPS approach with vertical guidance:

- EXTERNAL NAVIGATOR:** Ensure a GPS approach with vertical guidance (LPV, LP+V, LNAV/VNAV, LNAV+V) is loaded into the active flight plan.

- 2) EXTERNAL NAVIGATOR: Ensure the 'GPS' indication is showing in the lower-left corner. If not, press the CDI Key.
- 3) G3X Touch: Ensure that GPS1 is the selected navigation source on the PFD.
- 4) EXTERNAL NAVIGATOR: Select and activate the GPS approach using the PROC Key.
- 5) G3X Touch: From the PFD touch the autopilot then touch **APPR**.

Or:

Press the **APR** Key on the GMC control unit.

LOCALIZER WITH GLIDESLOPE

LOC Mode (lateral) and GS Mode (vertical) are both armed by touching **APPR** from the G3X Touch PFD or by pressing the **APR** Key on the GMC control unit. LOC/ILS approach captures are inhibited if the difference between aircraft heading and localizer course exceeds 105°.



NOTE: To cancel Glideslope (GS) Mode without canceling LOC Mode, touch **NAV** once. Pressing it a second time cancels LOC Mode.

Selecting LOC Mode with GS Mode:

- 1) EXTERNAL NAVIGATOR: Tune and activate the desired LOC frequency.
- 2) G3X Touch: Ensure that LOC1 is the selected navigation source. The HSI should automatically slew the needle to the correct course.
- 3) G3X Touch: From the PFD touch the autopilot then touch **APPR**.

Or:

Press the **APR** Key on the GMC control unit.

This simultaneously selects LOC Mode and GS (Glideslope) Mode. If the localizer deviation is less than half-scale when touching APPR or the APR Key is pressed, the autopilot will activate LOC Mode and track the localizer, otherwise LOC Mode is armed and the pilot is responsible for intercepting the localizer.

If the following occurs, the autopilot reverts to Roll Hold Mode (wings rolled level):

- Approach Mode is active and the Navigation source is manually switched

- The localizer signal is lost

If the Glideslope signal is lost, GS Mode will revert to Pitch Hold Mode and hold the last pitch attitude.

COUPLED ILS APPROACH WITH PROCEDURE TURN



NOTE: Configuration of a combination GPS/VLOC external navigator (GPS 175, GNX™ 375, GTN, or GNS) is required for a coupled ILS approach.

The combination GPS/VLOC external navigator (GPS 175, GNX 375, GTN, or GNS), G3X Touch, and autopilot can be used to fly a full ILS approach with procedure turn, from the enroute environment to the missed approach point.

Setting up a coupled ILS approach:

- 1) **EXTERNAL NAVIGATOR:** Ensure the 'GPS' indication is showing in the lower-left corner. If not, use the CDI Key.
- 2) **G3X Touch:** Ensure that GPS1 is the selected navigation source on the PFD.
- 3) **EXTERNAL NAVIGATOR:** Select and activate the ILS approach using the PROC Key.
- 4) **G3X Touch:** From the PFD touch the autopilot and touch **NAV** to activate GPS Mode. The flight director should start navigating to the IAF (Initial Approach Fix).

Or:

Press the **NAV** Key on the GMC control unit.

- 5) **EXTERNAL NAVIGATOR:** Tune and identify the localizer frequency by pressing the VLOC Flip-flop Key. (Note: The external navigator should have automatically loaded the localizer frequency into the standby VLOC slot.)
- 6) **G3X Touch:** From the PFD touch the autopilot and touch **APPR** to arm LOC and GS modes. Touch **ALT**.

Or:

Press the **APR** Key on the GMC control unit.

GPS Mode is now active and LOC Mode is armed in the roll axis. ALT Mode is active and GS is armed in the pitch axis. The flight director should now navigate the entire approach from the IAF (Initial Approach Fix) to the MAP (Missed Approach Point) with the only adjustment being the throttle.



NOTE: Check step #5 if the external navigator doesn't automatically switch from GPS to VLOC Mode shortly after turning inbound on the final approach course.

LEVEL MODE

Level Mode is coupled in pitch and roll modes and is annunciated as both the vertical and lateral modes when active. Pressing the **LVL** Key engages the autopilot in Level vertical and lateral modes. Level Mode does not track altitude or heading. When the **LVL** Key is pressed all armed and active modes are canceled and the autopilot and flight director revert to LVL mode for pitch and roll. While in level mode, all other modes are available by pressing the corresponding button.

9.4 NON-GARMIN AUTOPILOTS

When interfacing the G3X Touch with a non-Garmin autopilot, the following applies:

- The PFD can be used to select 'Course' and 'Heading' for non-Garmin autopilots.
- G3X Touch cannot support NAV source selection between two external navigators for a non-Garmin autopilot, therefore installations with a non-Garmin autopilot are limited to one external navigator interface.
- The PFD supports GPS Steering (GPSS) mode which converts GPS roll steering commands into heading commands for non-Garmin autopilots that lack a GPS Navigation interface. GPSS mode is selected/deselected directly on the PFD. Either the internal G3X Touch flight plan can be used or the external flight plan from a compatible Garmin navigator. While GPSS mode is active on the G3X Touch PFD, the pilot must select 'GPS' as the active NAV source and 'Heading' mode on the non-Garmin autopilot.

GPS STEERING (GPSS)



NOTE: GPS Steering is only applicable to non-Garmin autopilots.

GPS Steering (GPSS) provides roll command signals calculated by the GPS navigator to the non-Garmin autopilot in order to allow the aircraft to anticipate turns, make smooth transitions when passing waypoints, and fly leg types such as procedure turns and holding patterns.

GPS Steering is enabled by selecting 'GPS' as the active navigation source, HDG mode on the non-Garmin autopilot, and touching **GPSS** on the PFD Options menu.

Enabling GPSS Mode:

- 1) From the PFD, touch the HSI to display the PFD Options menu.
- 2) Touch **GPS** from the 'CDI Source' options.
- 3) Touch **GPSS**.

When GPSS is enabled, the heading bug will change to a hollow outline, and a crossed-out heading bug symbol is displayed indicating the autopilot is not coupled to the heading bug. The heading bug is still controllable and may still be used for reference.



GPSS Enabled (PFD)

GPSS Enabled (PFD Options Menu)

If the GPSS data is invalid (for example, if there is not an active GPS leg) or the selected HSI source on the G3X Touch is not GPS, the annunciated "GPSS" text will turn yellow and a zero turn command will be sent to the autopilot.



GPSS Invalid (PFD)

- System Overview
- Flight Instruments
- EIS
- CNS Interface
- GPS Navigation
- Flight Planning
- Hazard Avoidance
- Additional Features
- AFCS**
- Annun/Alerts
- Appendix
- Index

SECTION 10 ANNUNCIATIONS & ALERTS

10.1 MISCELLANEOUS MESSAGE ADVISORIES

Message	Comments
Approaching Target Altitude	Within 200 feet of final VNAV target altitude.
Approaching VNAV Profile	The aircraft is within one minute of reaching the initial VNAV descent point.
Arriving at XXX	The aircraft is nearing the destination.
Can't Unlock Maps	No applicable unlock code for one or more maps was found. All MapSource maps are not accessible.
Database Error	Internal problem with the system. Contact your dealer.
Switch Fuel Tanks	A reminder for switching fuel tanks. The reminder message repeats at the specified interval after the beginning of each trip.
Lost Satellite Reception	The system is unable to receive satellite signals.
Memory Full	System memory is full, no further data can be saved.
Proximity Alarm XXXXX	You have reached the distance set for a proximity waypoint.
Next DTK XXX	The aircraft is nearing a turn in a route.
No SXM Signal	The SXM antenna is not receiving a signal.
Proximity Alarm Memory Full	No additional proximity waypoints can be saved.
Proximity Waypoints Overlap	The radius of two proximity waypoints overlap.
Route Already Exists	A route name that already exists has been entered.
Route Memory Full	No additional routes can be saved.
Route Truncated	Uploaded route from another device has more than 300 waypoints.
Route Waypoint Memory Full	No additional route waypoints can be saved.
Saving SXM Program Information	An SXM Radio channel lineup change has occurred and the unit is saving the channel lineup to memory.

System Overview

Flight Instruments

EIS

CNS Interface

GPS Navigation

Flight Planning

Hazard Avoidance

Additional Features

AFCS

Annun/Alerts

Appendix

Index

Message	Comments
Steep Turn Ahead	Approaching a turn that requires a bank angle in excess of 25 degrees to stay on course.
Track Already Exists	A saved track with the same name already exists.
Track Log Full	The track log is full and track recording was turned off. To record more track points, you need to clear the track log and turn track recording on.
Track Memory Full	No more track data can be stored. Delete the old track data to store the new data.
Transfer Complete	Data transfer was completed.
VNAV Cancelled	VNAV function has been cancelled due to a change in the active route.
Waypoint Already Exists	A waypoint with the same name already exists.
Waypoint Memory Full	The unit has stored the maximum number of waypoints.

Miscellaneous Message Advisories

10.2 AIRSPACE MESSAGES

Message	Comments
Inside Airspace	Inside the boundaries of the airspace.
Airspace Near and Ahead	Within two nautical miles of an airspace and your current course takes you inside the airspace.
Airspace Ahead, Within 10 Minutes	The projected course takes you inside an airspace within the next 10 minutes or less.
Airspace Near, Within 2 nm	Within two nautical miles of an airspace but not projected to enter it.

10.3 SYSTEM STATUS MESSAGES

A yellow (Messages) alert will flash at the bottom of the display. Messages are removed when they no longer apply. Flashing stops when all messages have been viewed.



Message Alert

Accessing messages:

Touch **Messages** at the bottom of the screen to view.

Or:

Touch **Main Menu > Tools > Messages**.

SYSTEM STATUS MESSAGES

Message	Comments
[LRU name] hardware fault	The specified LRU has a hardware fault and requires service.
Config module error	The GDU™ has encountered a problem writing to/from the config module. The G3X Touch™ system should be serviced.
Config module missing	The PFD config module is not connected.
[LRU name] using backup RS-232 interface	The specified LRU was wired for both CAN and RS-232 communication paths, and the device is not communicating via CAN.
[LRU name] temperature out of spec	The specified LRU is either too hot or too cold. Check installation and/or hardware for cause.
[LRU name] power supply fault	The specified LRU's internal power supply has a problem or the input voltage is out of the required specifications.
AHRS not calibrated	The specified AHRS is either not calibrated or requires the post installation calibration procedure. See G3X Touch installation manual for calibration instructions.
AHRS magnetometer not calibrated	The specified AHRS is either not calibrated or requires the magnetometer post installation calibration procedure. See G3X Touch installation manual for calibration instructions.
AHRS not receiving magnetometer data	The specified AHRS is not receiving magnetometer data. Check installation and configuration.
AHRS not receiving air data	The specified AHRS is not receiving air data. Check installation and configuration.
AHRS not receiving GPS data	The specified AHRS is not receiving any or any useful GPS information. Check installation and configuration.

Message	Comments
AHRS magnetic anomaly - check mag installation	An anomaly has been detected in the magnetometer data. Heading may or may not be flagged invalid.
AHRS magnetic field model invalid	The data being communicated by the GMU to the specified AHRS is invalid. Heading is flagged invalid and the AHRS will use GPS for backup mode operation.
AHRS IGRF data out of date	The AHRS Earth magnetic field model is out of date. Update magnetic field model when practical by updating the GDU to software version 9.15 or later and updating to the latest navigation database.
Network communication error	Two or more LRUs may have the same network address. Check wiring and configuration.
[LRU name] Network address changed	One or more LRUs on the CAN bus have an indeterminate network address. This likely indicates a wiring issue or an intermittent connector pin. If the problem persists, the G3X Touch system should be serviced.
[GDU name] software version mismatch	The PFD and MFD do not have the same software version installed. Display crosstalk is disabled. Ensure all installed display software matches.
[GDU name] obstacle database mismatch	The PFD and MFD have different obstacle database versions installed. Install the correct obstacle database on all displays for proper terrain/obstacle alerting.
[GDU name] obstacle database missing	The obstacle database is missing. Install the correct obstacle database on all displays for proper terrain/obstacle alerting.

- System Overview
- Flight Instruments
- EIS
- CNS Interface
- GPS Navigation
- Flight Planning
- Hazard Avoidance
- Additional Features
- AFCs
- Annun Alerts
- Appendix
- Index

Message	Comments
[GDU name] terrain database mismatch	The PFD and MFD have different terrain database versions installed. Install the correct terrain database on all displays for proper terrain/obstacle alerting.
[GDU name] terrain database missing	The terrain database is missing. Install the correct terrain database on all displays for proper terrain/obstacle alerting.
[GDU name] navigation database mismatch	The PFD and MFD have different navigation database versions installed. Install the correct navigation database on all displays for proper navigation.
[GDU name] navigation database missing	The navigation database is missing. Install the correct navigation database on all displays for proper navigation.
[GDU name] audio database missing.	The audio database is missing. Return unit for service
[GDU name] audio database incompatible	The audio database is incompatible. Return unit for service
Using external GPS position data	The display that is configured for a GPS antenna connection is not available; the remaining displays are using 2D GPS position data from an external GPS navigator.
[GDU name] GPS antenna not connected	The display that is configured for a GPS antenna connection does not detect any antenna current draw from the GPS antenna RF connector.
[GDU name] GPS antenna shorted to ground	The display that is configured for a GPS antenna connection detects the GPS antenna RF connector is shorted to ground.
[GDU name] GPS receiver needs service	The internal GPS receiver in the specified GDU is not responding. The affected GDU should be serviced.

Message	Comments
SXM receiver needs service	The display should be serviced when possible.
Not receiving external GPS [number] RS-232 Aviation data	Not receiving RS-232 data from the specified external GPS navigator.
Not receiving GTX TIS-A RS-232 data	Not receiving RS-232 data from the GTX.
Not receiving nav/comm [number] RS-232 data	Not receiving RS-232 data from the nav/comm.
VHF nav/comm communication error	Incorrect OBS value received from nav/comm. Check nav/comm OBS resolver setup (see Installation Manual guidance).
Not receiving data on ARINC 429 channel [number]	Data is not being received on the specified ARINC 429 input (port number can be 1-4).
ARINC 429 receiver error	Data received on an ARINC 429 input does not match the expected configuration.
Using internal GPS flight plan for navigation	Communication with the external GPS navigation source has failed. The G3X Touch internal flight plan is being used for navigation.
Aviation waypoint was deleted	A waypoint that was part of a stored flight plan was deleted from the latest navigation database. Check stored flight plans
Aviation waypoint has moved	A waypoint that was part of a stored flight plan was moved. Check stored flight plans.
Demo Mode - Do not use for navigation	The system is in demo mode, do not use for navigation.
Point no longer in navigation database	Displayed when the user attempts to activate a flight plan with invalid waypoints.

10.4 AUDIO ALERTS

VOICE ALERTS

- “Five Hundred”—when the aircraft descends through 500 feet above the destination airport.
- “Vertical Track”—one minute prior to the initial descent point in a VNAV profile.

The following voice terrain alerts are issued when flight conditions meet parameters that are set within the software algorithms, and are dependent on the sensitivity level set in the Terrain Setup Menu.

Alert Severity	Terrain	Obstacle	Descent Rate
Caution	“caution, terrain” “caution, terrain ahead”	“caution, obstacle” “caution, obstacle ahead”	“caution, sink rate”
Warning	“terrain ahead! pull up!” “terrain! terrain! pull up! pull up!”	“obstacle ahead! pull up!” “obstacle! obstacle! pull up! pull up!”	“sink rate, pull up!” “pull up!”

Voice Alerts Summary

AOA AURAL ALERT

When a G3X Touch is configured with a GSU 25, a GAP 26, and AOA is configured, the G3X Touch will issue an aural alert when the aircraft’s pitch attitude approaches a stall. A persistent beeping will begin at the first red chevron and will become progressively faster as the AOA is increased. A constant tone will be heard at the second red chevron indicating a stall condition.



Angle of Attack Display (AOA)

10.5 PFD ANNUNCIATIONS AND ALERTING FUNCTIONS

The following annunciations and alerting functions are displayed on the PFD.

MARKER BEACON ANNUNCIATION

Marker Beacon annunciations are displayed on the PFD to the left of the Selected Altitude. Outer marker reception is indicated in blue, middle in amber, and inner in white. Refer to the CNS Interface Section for more information regarding Marker Beacons.

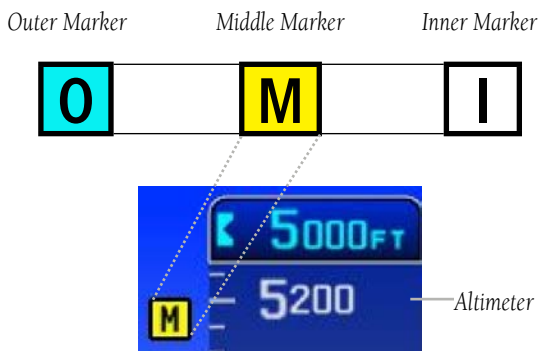

Marker Beacon Annunciations

CAS MESSAGES



NOTE: A standalone MFD does not display CAS messages.

The CAS messages displayed depend upon the current configuration, and will vary from the examples listed below. Refer to the G3X Touch Installation Manual for more information on configuring CAS messages (if applicable).

CAS Messages are grouped by criticality (warning, caution, advisory, and safe):

- **WARNING (red):** Requires immediate attention. Warning messages will flash until acknowledged by pressing the **BACK** Key or touching the on-screen message.
- **CAUTION (yellow):** Requires pilot awareness and possible future corrective action.
- **ADVISORY (white):** Provides general information.
- **SAFE (green):** Indicates a safe condition (i.e., GEAR DOWN).

Warning annunciation text is shown in red in the CAS Annunciation Window on the full-screen PFD and/or split-screen PFD Page.

Touch on an active CAS message to acknowledge it.

When in split-screen mode on the GDU 470, the CAS Window is hidden. A yellow or red warning symbol is depicted on the PFD indicating the presence of a CAS message. To view the CAS message(s) return to full screen PFD mode.



Caution CAS Message Symbol

Caution CAS Message Symbol
(Split-Screen GDU 470)

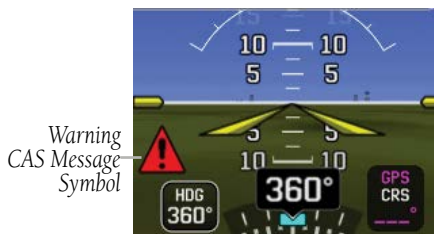

Warning CAS Message Symbol

Warning CAS Message Symbol
(Split-Screen GDU 470)

CAS Message	Pilot Action	Cause
AHRS FAIL	Use standby attitude source, or , if AHRS REVERT message is also displayed, continue to use the G3X Touch. Attitude will be from the G5.	The GSU 25 AHRS has failed.
ADC FAIL	Use standby airspeed and altimeter indicator, or, if ADC REVERT message is also displayed, continue to use the G3X Touch.	The GSU 25 air data computer has failed.
AHRS REVERT	Continue to use the G3X Touch	The GSU 25 AHRS has failed and attitude from the G5 or GI 275 is being displayed on the G3X Touch.
ADC REVERT	Continue to use the G3X Touch	The GSU 25 air data computer has failed and air data from the G5 or GI 275 is being displayed on the G3X Touch.
ECS FAIL	Landing and taxi lights may be inoperative if the aircraft is equipped with flashing (wig-wag) landing and taxi lights. At night, consider a well-lighted runway.	The GAD 27 has lost power or has failed.

- System Overview
- Flight Instruments
- EIS
- CNS Interface
- GPS Navigation
- Flight Planning
- Hazard Avoidance
- Additional Features
- AFCS
- Annun/Alerts
- Appendix
- Index

TERRAIN ANNUNCIATIONS

In addition to the Terrain Pop-up Alert in the lower left corner of the page, terrain and obstacle annunciations appear on the PFD in the upper left corner of the Attitude Indicator. Refer to the Hazard Avoidance Section for more details.

TRAFFIC ANNUNCIATIONS

The G3X Touch displays traffic symbolically on the Map Page, and the Traffic Warning Window (Inset Map). Refer to the Hazard Avoidance Section and the Annunciations and Alerts section for more details.

AHRS ALERTS (OPTIONAL)









REVERSION ALERTS

If a Garmin G5 or GI 275 standby flight display is present and the primary ADAHRS source is unavailable, the messages 'AHRS REVERT' and 'ADC REVERT' will appear. These messages indicate the PFD has reverted to using attitude and air data from the standby flight display instead of a dedicated ADAHRS unit.

COMPARISON ALERTS

Critical values generated by redundant sensors are monitored by comparators. If differences in the sensors exceed a specified amount, the Comparator Window appears in the lower right corner of the PFD and the discrepancy is annunciated in the Comparator Window as a 'MISCOMP' (miscompare).

If a Garmin G5 standby flight display is configured, the following comparison alerts may appear:

G5 Annunciation/Message	G3X Touch PFD Annunciation	Pilot Action	Description
 Attitude miscompare	ATT MISCOMP	Cross check the flagged information against other sources to identify erroneous information.	The attitude, heading, airspeed, or altitude information between the GSU 25 ADAHRS unit and the G5 is conflicting.
 Heading miscompare	HDG MISCOMP		
 Airspeed miscompare	IAS MISCOMP		
 Altitude miscompare	ALT MISCOMP		
 Attitude no compare	ATT NO COMP	Cross check information between the G5 and the PFD to determine which unit is in error.	The attitude, heading, airspeed, or altitude information between the GSU 25 ADAHRS unit and the G5 cannot be compared.
 Heading no compare	HDG NO COMP		
 Airspeed no compare	IAS NO COMP		
 Altitude no compare	ALT NO COMP		

Comparison Alerts

Each of the given MISCOMP/NO COMP messages relate to a parameter communicated to the G3X Touch PFD and G5 from the GSU 25 ADAHRS unit. The G3X Touch PFD and G5 both conduct checks to validate the ADAHRS data. If there is a disagreement between the GSU 25 ADAHRS unit and the PFD or G5, the yellow MISCOMP message for the specific parameter (e.g., heading) is displayed. If the PFD or G5 determines it is unable to perform miscompare monitoring for any of the given attitude, heading, airspeed, and altitude parameters communicated by the ADAHRS, the unit will display a white NO COMP message for that parameter.



NOTE: If a Garmin GI 275 Standby Flight Instrument is installed with the G3X Touch, comparison annunciations for attitude, airspeed, and altitude will only be displayed on the GI 275. Reference GI 275 Pilot's Guide p/n 190-02246-01 for more information. It is possible to get attitude comparison annunciations on the GI 275 when performing aggressive maneuvers including aerobatics. These annunciations can be disregarded in VFR conditions provided the annunciation disappears once the aircraft has returned to standard flight maneuvers.

AFCS ALERTS (OPTIONAL)



AFCS Alerts

STATUS ALERTS

If the commanded operation cannot be achieved due to the limitations configured, the following messages can be displayed over the pitch scale. The annunciation is removed once the condition is resolved.

Alert Condition	Annunciation	Description
Up-elevator Trim Required	↑ TRIM UP ↑	The autopilot does not have the required elevator authority to reach the desired flight condition.
Down-elevator Trim Required	↓ TRIM DOWN ↓	
Pitch Trim	PTRIM	Manual Electric Pitch Trim is inoperative.

Status Alerts

The following messages are displayed in the AFCS Status Field.

- System Overview
- Flight Instruments
- EIS
- CNS Interface
- GPS Navigation
- Flight Planning
- Hazard Avoidance
- Additional Features
- AFCS
- Annun Alerts
- Appendix
- Index

Alert Condition	Annunciation	Description
Autopilot Failure	AP	Autopilot inoperative
Manual Autopilot Disengagement	AP	Autopilot Disengaged
Yaw Damper Failure	YD	Yaw Damper inoperative
Yaw Damper Manual Disengagement	YD	Yaw Damper Disengaged
Flight Director and Autopilot Failure	AFCS	Flight Director and Autopilot inoperative
Autopilot Failure		Autopilot inoperative, Flight Director operative
Autopilot Preflight Test	PFT	Autopilot preflight test is in progress.

AFCS System Alerts

A flashing yellow mode annunciation (ROL, GPS, etc.) and annunciator light indicate loss of sensor (ADC, AHRS) or navigation data (VOR, LOC, GPS, VNAV) required to compute commands.

AFCS AURAL ALERT

Manual disengagement of the autopilot is indicated by a five-second flashing yellow 'AP' annunciation and an aural (bee-boop) alert. Cancel the aural alert by pressing and releasing the **AP** Button again.

The aural alert can also be canceled by touching the 'AP' annunciation in the Autopilot Status Box at the top of the PFD. Note that if the AP circuit breaker is pulled, touching the 'AP' annunciation is the only means of canceling the aural alert.

System
Overview

Flight
Instruments

EIS

CNS
Interface

GPS
Navigation

Flight
Planning

Hazard
Avoidance

Additional
Features

AFCS

Annun. Alerts

Appendix

Index

Blank Page

SECTION 11 APPENDICES

APPENDIX A: DATA FIELD OPTIONS

DATA BAR FIELD OPTIONS

Data Bar Field	Definition
AGL - Height Above Ground Level	Height Above Ground Level. This field will display dashes when below a specified AGL.
BRG - Bearing to Waypoint	The compass direction from the present position to the next waypoint.
CABIN - Cabin Altitude	Current pressure altitude of aircraft cabin (Requires a compatible CO detector)
CLG - Climb Gradient	Current climb gradient (climb rate divided by groundspeed) in percent.
CLM - Climb Gradient (ALT/NM)	Current climb gradient (climb rate divided by groundspeed) in altitude per nautical mile.
CO -Carbon Monoxide (PPM)	Displays current carbon monoxide level in parts per million. (Requires a compatible CO detector.)
DA - Density Altitude	Pressure Altitude adjusted for non-standard temperature.
DIST - Distance to Waypoint	The distance to the next waypoint in the Active Flight Plan.
DISTD - Distance to Destination Waypoint	The distance to the destination waypoint in the Active Flight Plan.
DTK - Desired Track	The desired course between the active "from" and "to" waypoints.
ECO - Fuel Economy	This value is calculated by dividing the current ground speed by the current fuel flow.
EDR - Fuel Endurance	This value is obtained by dividing the amount of fuel on board by the current fuel flow (endurance to empty - no reserve included).

DATA BAR FIELD OPTIONS

Data Bar Field	Definition
ESA - En Route Safe Altitude	The recommended minimum altitude within ten miles left or right of the desired course on an active flight plan or direct-to.
ETA - Estimated Time of Arrival	The estimated time at which the aircraft should reach the next waypoint, based upon current ground speed and track.
ETAD - Estimated Time of Arrival	The estimated time at which the aircraft should reach the destination waypoint, based upon current ground speed and track.
ETE - Estimated Time En Route	The estimated time it takes to reach the next waypoint from the present position, based upon current ground speed.
ETED - Estimated Time Enroute to Destination	The estimated time it takes to reach the destination waypoint from the present position, based upon current ground speed.
ETV - Estimated Time to VNAV	The estimated time it takes to reach the VNAV waypoint from the present position, based upon current ground speed.
FOD - Fuel Over Destination	The estimated amount of fuel remaining when the aircraft reaches the destination waypoint. Calculated by multiplying fuel flow times estimated time enroute (ETED) and subtracting from fuel remaining (REM).
FL - Flight Level	Altitude in hundreds of feet (regardless of system set altitude units).
FLT - Flight Time	The total time in flight.
FF - Fuel Flow	The current fuel flow.
G - G-Meter	The amount of positive or negative G's.
GPS ALT - GPS Altitude	The current altitude in geometric height above Mean Sea Level (MSL).

DATA BAR FIELD OPTIONS

Data Bar Field	Definition
GR - Glide Ratio	The ratio of horizontal distance (distance traveled over the ground) to vertical distance traveled (nn.n:1).
GS - Ground Speed	The velocity the aircraft is traveling relative to a ground position.
ISA - ISA Temperature Deviation	The difference between OAT and the standard atmospheric temperature at the current altitude.
LCL - Time of Day (Local)	The current time and date in 12-hour or 24-hour format.
MACH - Mach Number	A unit of speed that measures the ratio of the speed of an airplane to the speed of sound in the same atmospheric conditions.
MSA - Minimum Safe Altitude	Uses Grid MORAs to determine a safe altitude within ten miles of the aircraft's present position.
OAT - Outside Air Temperature	The static air temperature outside the aircraft. This is the temperature measured by the OAT probe, with correction for ram temperature rise.
RAT - Ram Air Temperature	The temperature measured by the OAT probe, without correction for ram temperature rise.
REM - Fuel Remaining	The current fuel remaining adjusted for fuel burn and based on fuel flow.
TRK - Ground Track	Direction of aircraft movement relative to a ground position.
USD - Fuel Used	The quantity of fuel used based on fuel flow.
UTC - Time	The current time in Universal (UTC) time.
VSR - Vertical Speed Required	The vertical speed necessary to descend/climb from the current position and altitude to the previously selected VNAV position and altitude, based upon current ground speed.

System Overview

Flight Instruments

EIS

CNS Interface

GPS Navigation

Flight Planning

Hazard Avoidance

Additional Features

AFCS

Annun/Alerts

Appendix

Index

DATA BAR FIELD OPTIONS

Data Bar Field	Definition
WPT - Next Waypoint	The next waypoint in the flight plan or direct-to route.
WX ALTIM	The altimeter setting at the nearest METAR reporting station.
WX WIND	The surface wind at the nearest METAR reporting station.
XTK - Crosstrack Error	The distance the aircraft is from a desired course in either direction, left or right.

INFO PAGE DATA FIELD OPTIONS

Info Page Data Field Option	Definition
Accuracy (ACCURACY)	The current accuracy of the GPS determined location.
Bearing (BRG)	The compass direction from the present position to a destination waypoint.
Cabin Altitude (CABIN ALT)	Current pressure altitude of aircraft cabin (Requires a compatible CO detector)
Climb Gradient (Percent) (CLIMB GRAD)	Current climb gradient in (climb rate divided by groundspeed) in percent.
Climb Gradient (ALT/NM) (CLIMB/NM)	Current climb gradient (climb rate divided by groundspeed) in altitude per nautical mile.
Course to Steer (CTS)	The recommended direction to steer in order to reduce cross-track error and return to the course line.
Crosstrack Error (XTK)	The distance the aircraft is off a desired course in either direction, left or right.
Density Altitude (DENSITY ALT)	Pressure Altitude adjusted for non-standard temperature.

INFO PAGE DATA FIELD OPTIONS

Info Page Data Field Option	Definition
Desired Track (DTK)	The desired course between the active "from" and "to" waypoints.
Distance (Destination) (DIST DEST)	The distance to the destination waypoint in the Active Flight Plan.
Distance (Next Waypoint) (DIST NEXT)	The distance to the next waypoint in the Active Flight Plan.
Enroute Safe Altitude (ESA)	The recommended minimum altitude within ten miles left or right of the desired course on a active flight plan or direct-to.
FL - Flight Level	Altitude in hundreds of feet (regardless of system set altitude units).
Flight Timer (FLT TIMER)	Total time in-flight (HH:MM).
Fuel Economy (ECONOMY)	Current Mile Per Gallon (MPG), based upon ground speed and fuel flow.
Fuel Endurance (ENDURANCE)	This value is obtained by dividing the amount of fuel on board by the current fuel flow (endurance to empty - no reserve included).
Fuel Flow (FUEL FLOW)	The current fuel flow.
Fuel Remaining (FUEL REM)	The current fuel remaining adjusted for fuel burn and based on fuel flow.
Fuel Timer (FUEL TIMER)	Elapsed time since the Fuel Tank Reminder Alarm was last issued (HH:MM).
Fuel Used (FUEL USED)	The quantity of fuel used based on fuel flow.
Fuel Over Destination (FOD)	The estimated amount of fuel remaining when the aircraft reaches the destination waypoint. This value is calculated by multiplying fuel flow times estimated time enroute (ETED) and subtracting from fuel remaining (REM).
Glide Ratio (G/R)	The ratio of horizontal distance (distance traveled over the ground) to vertical distance traveled (nn.n:1).

INFO PAGE DATA FIELD OPTIONS

Info Page Data Field Option	Definition
GPS ALT - GPS Altitude	The current altitude in geometric height above Mean Sea Level (MSL).
Ground Speed (GS)	The velocity the aircraft is traveling relative to a ground position.
Ground Track (TRK)	The direction of aircraft movement relative to a ground position.
Height Above Ground Level (AGL)	Height Above Ground Level. This field will display dashes when below a specified AGL.
ISA Temp Deviation (ISA)	The difference between OAT and the standard atmospheric temperature at the current altitude.
Mach Number (MACH)	A unit of speed that measures the ratio of the speed of an airplane to the speed of sound in the same atmospheric conditions.
Minimum Safe Altitude (MSA)	Uses Grid MORAs to determine a safe altitude within ten miles of the aircraft's present position.
Next Waypoint (Next Waypoint)	The next waypoint in the flight plan or direct-to route.
Outside Air Temperature (OAT)	The static air temperature outside the aircraft. This is the temperature measured by the OAT probe, with correction for ram temperature rise.
Ram Air Temperature (RAT)	The temperature measured by the OAT probe, without correction for ram temperature rise.
Sunrise (SUNRISE)	The time at which the sun rises on this day (current location).
Sunset (SUNSET)	The time at which the sun sets on this day (current location).
SXM (Now Playing) (SXM)	The selection now playing on SiriusXM Radio.

INFO PAGE DATA FIELD OPTIONS

Info Page Data Field Option	Definition
Time En Route (Destination) (ETE DEST)	The estimated time it takes to reach the destination waypoint from the present position, based upon current ground speed.
Time En Route (Next) (ETE NEXT)	The estimated time it takes to reach the next waypoint from the present position, based upon current ground speed.
Time of Arrival (Destination) (ETA DEST)	The estimated time at which the aircraft should reach the destination waypoint, based upon current speed and track.
Time of Arrival (Next Waypoint) (ETA NEXT)	The estimated time at which the aircraft should reach the next waypoint, based upon current speed and track.
Time to VNAV (VNAV TIME)	The estimated time it takes to reach the VNAV waypoint from the present position, based upon current ground speed.
Time (Local) (TIME)	The current time and date in 12-hour or 24-hour format.
Time (UTC) (TIME)	The current time and date in Universal (UTC) time.
Vertical Speed (VS)	The rate of climb or descent (GPS-derived).
Vertical Speed Required (VSR)	The vertical speed necessary to descend/climb from the current position and altitude to the previously selected VNAV position and altitude, based upon current ground speed.
Wx (Altimeter) (WX ALTIM)	The altimeter setting at the nearest METAR reporting station.
Wx (Dew Point) (WX DEW PT)	The dew point at the nearest weather reporting station.
Wx (Rel. Humidity) (WX HUMIDITY)	The relative humidity at the nearest weather reporting station.

INFO PAGE DATA FIELD OPTIONS

Info Page Data Field Option	Definition
Wx (Temperature) (WX TEMP)	The temperature at the nearest weather reporting station.
Wx (Wind) (WX WIND)	The surface wind at the nearest METAR reporting station.

System
OverviewFlight
Instruments

EIS

CNS
InterfaceGPS
NavigationFlight
PlanningHazard
AvoidanceAdditional
Features

AFCS

Annun/Alerts

Appendix

Index

APPENDIX B: UTILITIES

FLIGHT LOG

The Flight Log shows a list of any recorded flights, including date, route of flight, and flight time. The G3X Touch™ saves up to 50 recorded flights. Entries on this list are automatically created for each flight.

With EIS items configured, recording begins when the engine hours timer or airframe total hours is running. This allows recording of time spent on ground before takeoff and after landing while the engine is running.

With no EIS items configured, recording begins when the aircraft reaches 250 feet of altitude. When the aircraft's groundspeed drops below 30 knots, the flight entry is saved and a new entry is recorded when departing the airport. A touch-and-go or brief stop of less than 10 minutes appends to the current flight record, rather than starting a new entry.

VIEWING THE FLIGHT LOG

Select any listed entry in the log to view additional information, including a map displaying the actual path flown.

Viewing details for a flight:

- 1) From the split-screen or standalone MFD, press the **MENU** Key twice to display the Main Menu.
- 2) Touch the **Flight Log** Button. The Flight Log Page is displayed. (Hours and minutes can be displayed by pressing the **MENU** Key and touching the **Show Hours and Minutes** Button). Tenths of hours is the default.
- 3) Touch the desired flight log in the list. The Flight Log Map Window is displayed. Date, start/stop times, route, hours, distance, and actual flight path are displayed.
- 4) Press the **Back** Key, or touch the Flight Log Page beside the Flight Log Map Window, to return to the Flight Log Page.

- System Overview
- Flight Instruments
- EIS
- CNS Interface
- GPS Navigation
- Flight Planning
- Hazard Avoidance
- Additional Features
- AFCs
- Annun/Alerts
- Appendix
- Index

Flight Log		
26-MAR-14	KOJC-____	0.2 Hours
26-MAR-14	KOJC-KMCI	4.6 Hours

Flight Log List

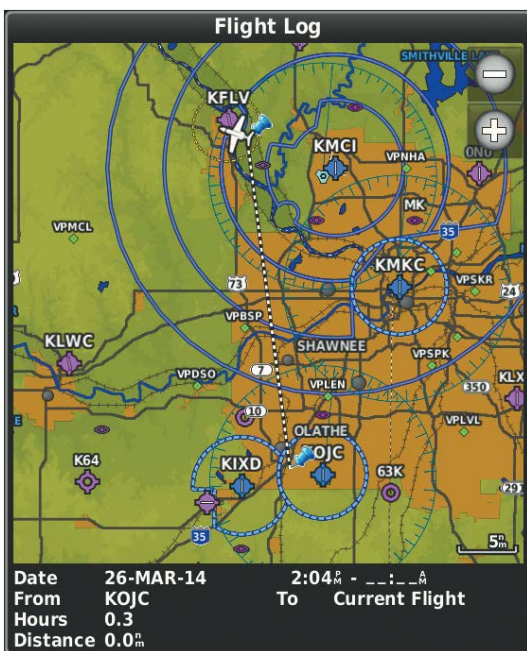

Flight Log Map

DELETING FLIGHT LOGS

You can delete a single flight log or delete all flight logs from the Flight Log.

Deleting a single flight log:

- 1) From the split-screen and/or full-screen MFD, press the **MENU** Key twice to display the Main Menu. (The 'Flight Log' option is not available from the full-screen PFD Main Menu).
- 2) Touch the **Flight Log** Button. The Flight Log Page is displayed.
- 3) Touch the desired flight log in the list. The Flight Log Map Window is displayed.
- 4) Press the **MENU** Key to display the flight log map menu.
- 5) Touch the **Delete Flight** Button.
- 6) Touch the **Yes** Button to delete the flight log.

Deleting all flight records:

- 1) From the split-screen and/or full-screen MFD, press the **MENU** Key twice to display the Main Menu. (The 'Flight Log' option is not available from the full-screen PFD Main Menu).
- 2) Touch the **Flight Log** Button. The Flight Log Page is displayed.
- 3) Press the **MENU** Key to display the flight log menu.
- 4) Touch the **Delete All** Button.
- 5) Touch the **Yes** Button to delete the flight log.

TRACK LOG

The G3X Touch draws an electronic bread crumb trail or “track log” on the Map Page. The track log contains points along its path, including time and location for each point.

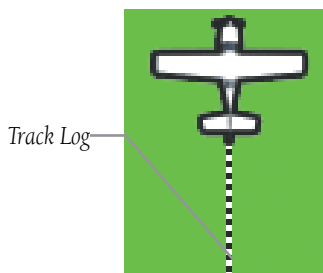

Track Log (Map Page)

The track log starts recording as soon as the G3X Touch gets a location fix. For the best results, clear the track log before each flight.

The percentage of memory used by the current track log appears at the top of the Track Log Window. After the track log is cleared, it shows zero percent. When the screen reaches 100%, the most recent track points start to overwrite the least recent track points (if ‘Wrap’ is selected in the Record Mode Field).

The Save feature allows storage of up to 15 track logs.

Displaying/removing the track log on the Map Page:

- 1) From the Map Page, press the **MENU** Key. The Map Options Window is displayed.
- 2) Touch the **Set Up Map...** Button to display the Map Setup Page.
- 3) Touch the **Line** Tab to display the track log setup options.
- 4) Touch the Track Log Show/Hide Button.
- 5) Touch the **Show** Button to display the track log. Touch the **Hide** Button to remove the track log.



Map Page Menu

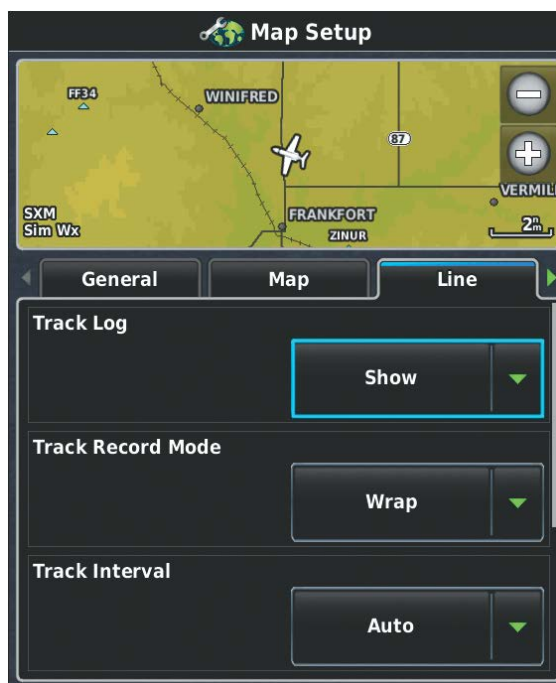

Map Setup Page - Line Tab

Changing track log settings:

- 1) From the Map Page, press the **MENU** Key. The Map Page Menu is displayed.
 - 2) Touch the **Set Up Map...** Button to display the Map Setup Page.
 - 3) Touch the **Line** Tab to display the track log setup options.
 - 4) Touch the button associated with the desired setting.
 - 5) Touch the button to select the desired option. Repeat step for each setting to be changed.
 - 6) Press the **BACK** Key to return to the Map Page.
- Track Record Mode - 'Wrap' records over the oldest tracks when the track log reaches 100%. 'Fill' records a track log until the track log is full (100%).
 - Track Interval - 'Distance' records track points after a specified distance has been traveled. 'Time' creates track points after a specified time has elapsed. 'Auto' records track points only when necessary to recreate the track (this has the benefit of saving memory on long straight flights).
 - Track Color - Select a color for the track when it appears on the map.

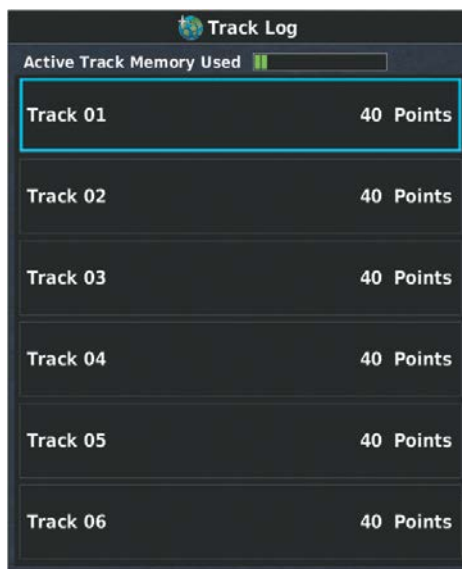

Track Log Window (Split-Screen)

Saving a track log:

- 1) From the split-screen or full-screen MFD, press the **MENU** Key twice. (The 'Track Log' option is not available from the full-screen PFD Main Menu).
- 2) Touch the **Track Log** Button. The Track Log Page is displayed.
- 3) Press the **MENU** Key to display the track log menu.
- 4) Touch the **Save Active Track** Button.
- 5) Touch the track selection button to choose what will be saved.

Entire Active Track, Past 24 Hours, Past 7 Days, Selected Flight, or Selected Dates

- 6) If Selected Flight or Selected Dates are chosen, select the flight or dates using the buttons.
- 7) Touch the **OK** Button to save the track, or touch the **Cancel** Button to cancel the save.

Editing a track log:

- 1) From the split-screen and/or full-screen MFD, press the **MENU** Key twice to display the Main Menu. (The 'Flight Log' option is not available from the full-screen PFD Main Menu).
- 2) Touch the **Track Log** Button. The Track Log Page is displayed.
- 3) Touch the desired track log in the list. The Saved Track Window is displayed.
- 4) Touch the Name Button to display the keypad. Use the keypad to select the name, then touch the **Enter** Button. Touch the **Cancel** Button to exit without changing the name.
- 5) Touch the Color Button to display a list of color choices. Touch the button for the desired color.
- 6) Touch the **Show on Map** Button to show the track on the map.

Deleting a single saved track log:

- 1) From the split-screen and/or full-screen MFD, press the **MENU** Key twice to display the Main Menu. (The 'Flight Log' option is not available from the full-screen PFD Main Menu).
- 2) Touch the **Track Log** Button. The Track Log Page is displayed.
- 3) Touch the desired track log in the list. The Saved Track Window is displayed.
- 4) Press the **MENU** Key to display the saved track menu.

- 5) Touch the **Delete Saved Track** Button.
- 6) Touch the **Yes** Button to delete the saved track, or touch the **No** Button to cancel the deletion.

Deleting all saved track logs:

- 1) From the split-screen and/or full-screen MFD, press the **MENU** Key twice to display the Main Menu. (The 'Flight Log' option is not available from the full-screen PFD Main Menu).
- 2) Touch the **Track Log** Button. The Track Log Page is displayed.
- 3) Press the **MENU** Key to display the track log menu.
- 4) Touch the **Delete All Saved Tracks** Button.
- 5) Touch the **Yes** Button to delete all saved tracks, or touch the **No** Button to cancel the deletion.

TRACK VECTOR

The G3X Touch draws an electronic "Track Vector" on the Map Page. The horizontal marks on the Track Vector can be set to 'time' or 'distance'. The entire length of the track is set to the specified time or distance and the lines are 'whole' values. When configured to 'time', the tick marks will always be on the whole minute, even if the total distance is set to XX:30 (mm:ss). When configured to 'distance' and the units are miles, the tick marks will always be on the whole mile, even if the total distance is a fraction (in this case, there would not be a tick mark at the end of the line).



Track Vector (Map Page)

Changing the Track Vector settings on the Map Page:

- 1) From the Map Page, press the **MENU** Key. The Map Page Menu is displayed.
- 2) Touch the **Set Up Map...** Button to display the Map Setup Page.
- 3) Touch the **Line** Tab to display the Track Vector setup options.
- 4) Touch the Track Vector Off/Distance/Time Button.
- 5) Touch the **Off** Button to turn the Track Vector On or Off.

Or:

Touch the **Distance** Button to define the length of the Track Vector by distance. Touch the distance value button to bring up the keypad to select the distance, and touch the **Enter** Button.

Or:

Touch the **Time** Button to define the length of the Track Vector by time. Touch the **+** Button or **-** Button to select the time. (Time is displayed in MM:SS)

- 6) Press the **BACK** Key to return to the Map Page.

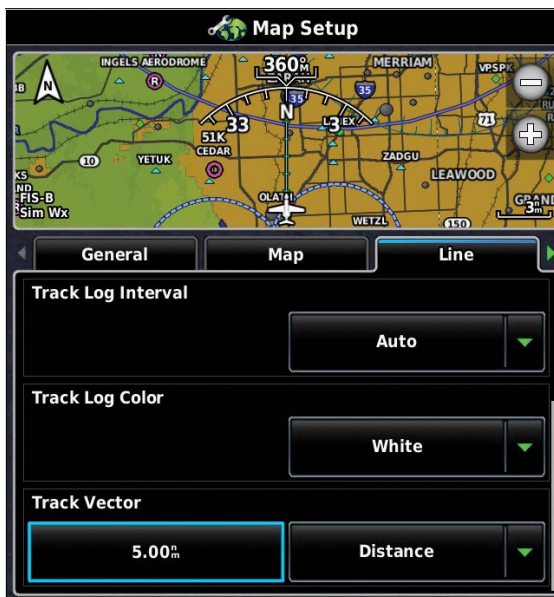

Track Vector Settings (Map Setup Page)

WEIGHT & BALANCE



NOTE: Refer to the G3X Touch Installation Manual for information on configuring the Weight & Balance Page.

Weight & Balance may be used during pre-flight preparations to verify the weight and balance conditions of the aircraft. By entering the weight values on this page, the G3X Touch can calculate the total weight, moment, and center of gravity (CG).



NOTE: This information is only for flight planning purposes. Consult the aircraft's pilot operating handbook for the official weight and balance data.

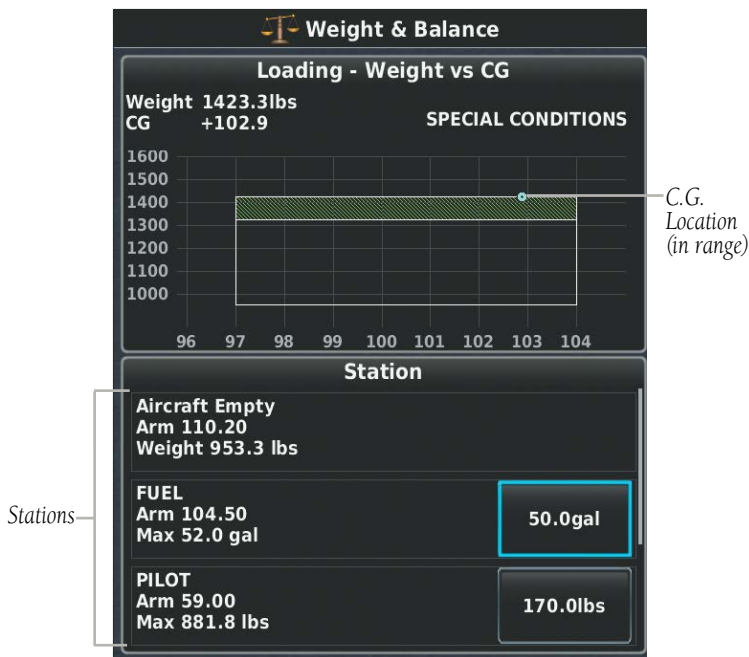

Weight and Balance Page - Weight vs C.G. (C.G. in Range)

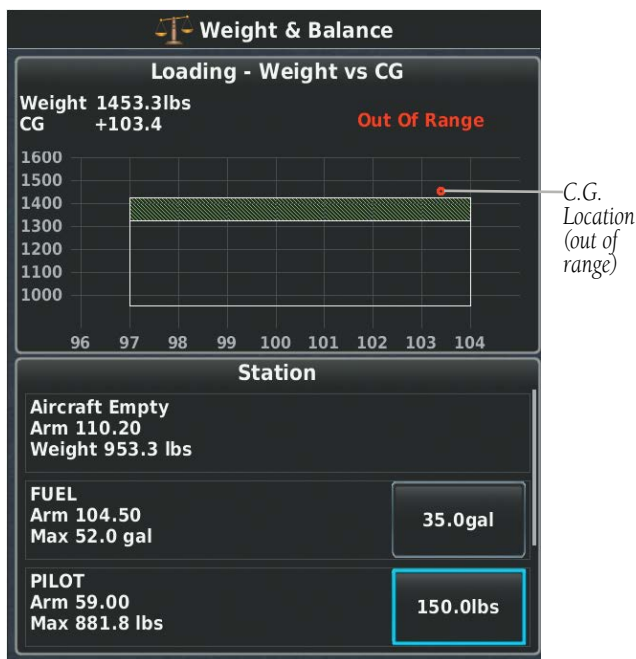

Weight and Balance Page - Weight vs C.G. (C.G. Out of Range)

Performing weight and balance calculations:

- 1) Press the **MENU** Key twice to display the Main Menu.
- 2) Touch the **Weight & Balance** Button. The Weight & Balance Page is displayed. (Kilograms can be displayed by pressing the **MENU** Key and touching the **Show Kilograms** Button)
- 3) Touch the desired station button. The FUEL keypad is displayed.
- 4) Use the keypad to select the desired weight, then touch the **Enter** Button. The calculated moment, weight, and CG figures are calculated and appear at the top of the page. Touch the **Cancel** Button to exit without changing the weight.
- 5) Repeat Steps 3 and 4 to enter the weights for each station.

Resetting weight & balance page:

- 1) From the Weight & Balance page, press the **MENU** Key.
- 2) Touch the **Empty Aircraft** Button.
- 3) Touch the **Yes** Button to empty the aircraft, or touch the **No** Button to cancel the action.



Weight & Balance Page Menu

If the Loading Limit for a particular station is exceeded, the station data will turn yellow.



Loading Limit Exceeded

DISPLAYING WEIGHT VS MOMENT

When configured, the Weight & Balance page can also display Weight vs Moment instead of Weight vs C.G.. Refer to the G3X Touch Installation Manual for more information on configuring the Weight & Balance page.

Displaying Weight vs Moment:

- 1) Press the **MENU** Key twice to display the Main Menu.
- 2) Touch the **Weight & Balance** Button. The Weight & Balance Page is displayed.
- 3) Press the **MENU** Key.
- 4) Touch **Show Weight vs Moment**.

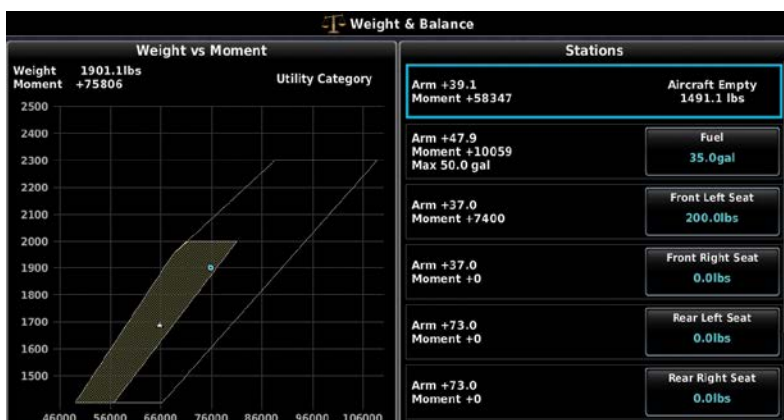

Weight and Balance Page - Weight vs Moment

PROXIMITY WAYPOINTS AND ALARMS

The Proximity Waypoints Page allows the pilot to define an alarm circle around a waypoint location. The Proximity Alarm will alert the pilot when the aircraft enters the boundary of the defined radius, however does not alert the pilot when leaving the radius.

Proximity Waypoint Alarms must be 'On' for alerting to occur, otherwise the Proximity Waypoint is simply a red circle on the navigation map.

Creating proximity waypoints:

- 1) Press the **MENU** Key twice to open the Main Menu.
- 2) Touch the **User Waypoints** Button. The User Waypoints Page is displayed.
- 3) Touch the **Proximity** Tab. The Proximity Waypoints List is displayed.
- 4) Press the **MENU** Key. The Proximity Waypoint Menu is displayed.
- 5) Touch the **New Proximity Waypoint** Button.
- 6) Touch the **Use Map** Button or the **Use Identifier** Button.
- 7) If using an identifier, select the desired waypoint using the Waypoint Identifier Window. Touch the **Enter** Key to create the proximity waypoint. Touch the **Cancel** Key to exit without creating a proximity waypoint.



Proximity Waypoint Alarm

Enabling/disabling proximity waypoint alarms:

- 1) Press the **MENU** Key twice to open the Main Menu.
- 2) Touch the **User Waypoints** Button. The User Waypoints Page is displayed.
- 3) Touch the **Proximity** Tab. The Proximity Waypoints List is displayed.
- 4) Press the **MENU** Key. The Proximity Waypoint Menu is displayed.
- 5) Touch the **Enable Proximity Alarms** Button, or the **Disable Proximity Alarms** Button, to enable/disable proximity alarms.

Or:

- 1) Press the **MENU** Key twice to open the Main Menu.
- 2) Touch the **Setup** Button. The Setup Page is displayed.
- 3) Touch the **Alarms** Button. The Alarms Setup Page is displayed.
- 4) Touch the Proximity Waypoint **On** Button or **Off** Button, to enable/disable proximity alarms.

Deleting a single proximity waypoint:

- 1) Press the **MENU** Key twice to open the Main Menu.
- 2) Touch the **User Waypoints** Button. The User Waypoints Page is displayed.
- 3) Touch the **PROXIMITY** Tab. The Proximity Waypoints List is displayed.
- 4) Touch the desired proximity waypoint in the list. The Proximity Waypoint Menu is displayed.
- 5) Touch the **Delete Proximity Waypoint** Button.
- 6) Touch the **Yes** Button to delete the proximity waypoint, or touch the **No** Button to cancel the deletion.

Deleting all proximity waypoints:

- 1) Press the **MENU** Key twice to open the Main Menu.
- 2) Touch the **User Waypoints** Button. The User Waypoints Page is displayed.
- 3) Touch the **PROXIMITY** Tab. The Proximity Waypoints List is displayed.
- 4) Press the **MENU** Key. The Proximity Waypoint Menu is displayed.
- 5) Touch the **Delete All** Button.
- 6) Touch the **Yes** Button to delete all proximity waypoints, or touch the **No** Button to cancel the deletion.

APPENDIX C: SD CARD USE AND DATABASES

 **NOTE:** It is recommended to maintain three SD cards for the G3X system. One SD card should be used exclusively for loading software, another SD card should be used exclusively for loading databases, and a third card should be used exclusively for flight purposes.

 **NOTE:** When flying the G3X system, any SD card(s) used in the GDU™(s) should contain only files which are necessary for the flight of the aircraft. Non-essential files may have a negative effect on display performance.

 **NOTE:** When database files are loaded to the SD card, any previously loaded database files of the same type residing on the SD card will be overwritten. This includes loading a database of a different coverage area or data cycle than that currently residing on the SD card.

 **NOTE:** In the event there is a file corruption problem with the SD card, it may be necessary to reformat the card. This can cause an issue when formatting the SD card using Mac OS, where the newly formatted card will not be recognized by the G3X Touch. When using a Macintosh computer to format the SD card, Garmin recommends using the SD Memory Card Formatter application available as a download from SDcard.org. When running the application, use the Quick Format option.

The G3X Touch uses an SD Card for software updates, database updates, MapSource® data, checklist files, Chartview, Flight Data Logging, exporting Track Logs/User Waypoints, importing/exporting Flight Plans and user-downloaded vehicles. Garmin recommends using a 8 GB SanDisk® or Toshiba® SD Card.

MapSource detailed maps are available from FlyGarmin.com. Refer to the Garmin website (www.garmin.com) for instructions on downloading software updates. Refer to the latest revision of the G3X Touch Installation Manual for software update instructions.

INSTALLING AND REMOVING SD CARDS



NOTE: SD Cards are not waterproof. They should not be exposed to moisture or excessive static charges, and should be stored in the case supplied with the card.

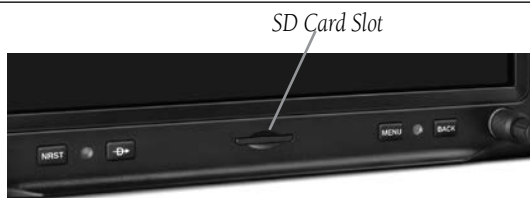

SD Card Slot - GDU™ 460 (10.6 inch)

Installing an SD Card:

- 1) Insert the card into the slot at the lower, center, front of the bezel. Be sure the SD Card contacts are facing downwards. (GDU 470: Insert card in the slot at the upper right, with the contacts facing right).
- 2) Firmly push the card into the unit. It is not necessary to force the card.

If you insert an SD Card and get a card format not recognized message, try removing the card and reinserting it. If the card is still not recognized, contact Garmin Product Support or your Garmin dealer.

Removing an SD Card:

- 1) Push the card into the unit until it stops.
- 2) Release the card. The card should eject for easy removal.
- 3) With the card ejected, pull the card out of the slot.

G3X TOUCH DATABASES

The following databases are available with the G3X Touch. See the Additional Feature section for information on Airport Directories, FliteCharts[®], and SafeTaxi[®]. See the Hazard Avoidance section for information on Obstacles and Terrain.

Refer to www.fly.garmin.com for available databases.

Database
Worldwide Basemap
Airport Directory (AOPA or AC-U-KWIK)
Navigation Database (Jeppesen® or by Garmin)
FliteCharts®
SafeTaxi®
Obstacle
Terrain
VFR Sectionals
IFR Charts

Available Databases

BASEMAP

The basemap database contains data for the topography and land features, such as river, lakes, and towns. It is updated only periodically, with no set schedule. There is no expiration date.

AIRPORT DIRECTORY DATABASES

The AOPA Airport Directory provides data on airports and heliports throughout the U.S. and it is updated on a 56-day cycle. Detailed information for over 5,300 U.S. airports, along with the names and phone numbers of thousands of FBOs can be viewed. This service allows the pilot to plan an overnight, choose fuel stops, find ground transportation, etc.

Optional airport directory databases such as AC-U-KWIK are also supported. AC-U-KWIK provides complete listings of FBOs, charter companies, fuel suppliers, ground transportation, maintenance and catering services at public airports across the world.

NAVIGATION DATABASE

The G3X Touch includes an internal navigation database that provides location and facility information for thousands of airports, VORs, NDBs, and more. Updates to the navigation database are available every 28 days online. There are two navigation database products available: the Jeppesen Navigation Database, which is sourced by Jeppesen, and Navigation Databases sourced by Garmin.



NOTE: *Although the Jeppesen Navigation Database and the US VFR Navigation Database contain much of the same information, pilots may notice differences in behavior, nearest list functionality, direct-to functionality, and map page display due to data content variations. The Navigation Databases do not contain any approach data.*

- *Airport—identifier, facility name, city/state/country, latitude/longitude, field elevation, available fuel types, runway designations and layout, runway surface, runway length, runway width, runway lighting, communication frequencies, and published approaches.
 - Weather—frequencies associated with an airport (ASOS, ATIS, and AWOS).
 - *VORs—identifier, facility name, city/state/country, location (latitude/longitude), frequency, service volume (high, low, terminal), and type (such as VOR-DME, TACAN, and VORTAC).
 - *NDBs—identifier, facility name, city/state/country, location (latitude/longitude), and frequency.
 - Intersections—identifier, nearest VOR, radial and distance from nearest VOR, location (latitude/longitude), and region/country.
 - ARTCC—Air Route Traffic Control Centers.
 - Airspace—boundaries (Class B, Class C, Control Zones, SUAs, and MOAs), controlling agency, and vertical boundaries.
 - FSS—Flight Service Stations.
- * Symbology used for NDBs, VORs, and airports is consistent with those used on a sectional chart.



NOTE: After performing a navigation database update, verify all flight plan(s) (routes) are current. If there is an obsolete aviation point in a saved route, the flight plan cannot be activated until the obsolete points are removed.

FLITECHARTS

The FliteCharts database contains procedure charts. This database is updated on a 28-day cycle. FliteCharts will not longer function 180 days after the expiration date.

CHARTVIEW

Chartview is Jeppesen's version of FliteCharts. The two versions of charts have the same basic information.

ChartView database is revised every 14 days. Charts are still viewable during a period that extends from the cycle expiration date to the disables date. ChartView is disabled 70 days after the expiration date and is no longer available for viewing. The ChartView database is always on the SD Card and is not copied to the GDU's internal memory.

A Chartview Key is available for purchase from FlyGarmin.com, but Chartview displays Jepp Charts available only from Jeppesen.

SAFETAXI

The SafeTaxi database contains detailed airport diagrams for selected airports. These diagrams aid in following ground control instructions by accurately displaying the aircraft position on the map in relation to taxiways, ramps, runways, terminals, and services. This database is updated on a 56-day cycle.

OBSTACLE

The obstacle database contains data for obstacles, such as towers, that pose a potential hazard to aircraft. Obstacles 200 feet and higher are included in the obstacle database. It is very important to note that not all obstacles are necessarily charted and therefore may not be contained in the obstacle database. This database is updated on a 56-day cycle.

TERRAIN

The terrain database is updated periodically and has no expiration date.



NOTE: The data contained in the terrain and obstacle databases comes from government agencies. Garmin accurately processes and cross-validates the data, but cannot guarantee the accuracy and completeness of the data.

UPDATING G3X TOUCH DATABASES

The G3X Touch database updates can be obtained by visiting the 'flyGarmin' website (www.fly.garmin.com). The 'flyGarmin' website requires the unit's System ID to update databases. This allows the databases to be encrypted with the unit's unique System ID when copied to the SD Card.

Obtaining the System ID:

- 1) Press the **MENU** Key twice to access the Main Menu.
- 2) Touch the **Tools** Button.
- 3) Touch the **Database Information** Button. The Database Information Page is displayed. Scroll down if necessary to see the System ID.



Database Information

US Obstacles Cycle 11B5 Effective 25-AUG-2011 to 20-OCT-2011 © 2011 Garmin Ltd. or its subsidiaries

Worldwide-9 Terrain Cycle 11T1 © 2011 Garmin Ltd. or its subsidiaries

AOPA Directory Data Cycle 10D5 Published 13-SEP-2010
© 2010 Aircraft Owners and Pilots Association

US IFR/VFR Charts Cycle 1109 Effective 25-AUG-2011 © 2011 Garmin Ltd. or its subsidiaries

Worldwide Aviation Basemap v2.00 © Garmin Ltd. or its subsidiaries Mda Federal, Inc 2008

Other System Information

System sbw WS Mar 25 2014 12:09:09 2.22b
© 2014 Garmin Ltd. or its subsidiaries

System ID: 6000200000001

Unit ID: 0000000001

Boot Block Software Version 0.00

X-Loader Software Version 0.00

Splash Screen Missing

System ID

Database Information Page

System Overview

Flight Instruments

EIS

CNS Interface

GPS Navigation

Flight Planning

Hazard Avoidance

Additional Features

AFCS

Annun/Alerts

Appendix

Index

Updating G3X Touch Databases:

Equipment required to perform the update:

- Windows-compatible PC computer
 - Verbatim 96504 SD Card Reader or equivalent
 - Updated database obtained from the flyGarmin website
 - SD Card, 8 GB recommended (Garmin recommends SanDisk[®] or Toshiba[®] SD cards)
- 1) After the data has been copied to the SD Card, insert the SD card in the SD card slot of the display.
 - 2) Power on the display. The Update Databases Page is displayed. A green checkbox indicates the database installed on the G3X Touch is up to date. An empty checkbox indicates the database on the SD card is more current and should be installed.

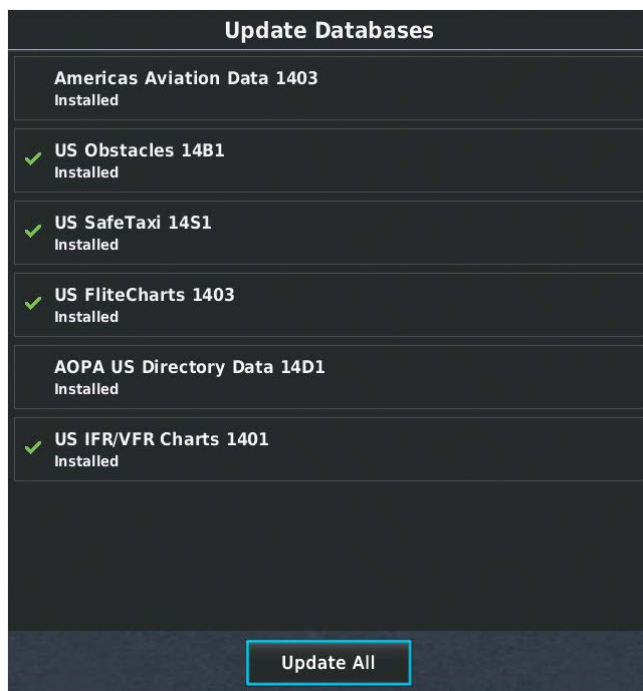

Update Databases Page

- 3) Touch the **Update All** Button. The database status is updated.

Or:

Touch a single database, and touch **NO/YES** on the 'Update selected database?' window. The selected database status is updated.



Update Databases Page (Database Status Updated)

- 4) Once the database(s) have been successfully updated, the SD Card can be removed from the unit.
- 5) Repeat steps 1-4 for the remaining GDUs if applicable.

Reloading G3X Touch Databases:

- 1) Insert the SD card containing the data to be reloaded into the SD card slot of the display.
- 2) Power on the display.
- 3) Press the **MENU** Key twice to open the Main Menu.
- 4) Touch **Tools**.
- 5) Touch Database Information.
- 6) Press the **MENU** Key.
- 7) Proceed with step 1-4 above.

IMPORTING/EXPORTING FLIGHT PLANS TO/FROM THE SD CARD

Refer to Section 6.1 for information on importing/exporting/renaming flight plans.

FLIGHT DATA LOGGING

The G3X Touch also has the ability to log flight data. Refer to the Additional Features section for more information.

APPENDIX D: MAP DATUM AND LOCATION FORMATS

MAP DATUMS

A datum is a mathematical model of the Earth that approximates the shape of the Earth and enables calculations to be carried out in a consistent and accurate manner. The datum is physically represented by a framework of ground monuments (such as trig. stations) whose locations have been accurately measured and calculated on this reference surface. Lines of latitude and longitude on a chart are referenced to a specific map datum. Every chart has a map datum reference and the G3X Touch can be set to match most of those commonly used.

LOCATION FORMATS

Your current location can be viewed on the GPS in the form of coordinates. Since different charts use different location formats, Garmin GPS units allow you to choose the correct coordinate system for the type of chart you are using. The most common format is latitude and longitude, which is used by all Garmin units. You can change the location format to use with other coordinate systems.

Map Datum and Location Format selection can be performed on the Position Setup Page.

Changing position settings:

- 1) Press the **MENU** Key twice to display the Main Menu.
- 2) Touch the **Setup** Button. The Setup Page is displayed.
- 3) Touch the **Position** Button. The Position Setup Page is displayed.
- 4) Touch the Location Format button. The Location Format choices are displayed. Touch the button with the desired format.
- 5) Touch the Map Datum button. The Map Datum choices are displayed. Touch the button with the desired format.
- 6) Press the **MENU** Key to display the Position Menu. Touch the **Restore Defaults** Button to restore the default settings for all the position items.



Position Setup Page

APPENDIX E: GENERAL TIS-A INFORMATION



NOTE: Aircraft without an operational transponder are invisible to TIS-A.



WARNING: Do not rely solely upon the display of traffic information for collision avoidance maneuvering. The traffic display does not provide collision avoidance resolution advisories and does not, under any circumstances or conditions, relieve the pilot's responsibility to see and avoid other aircraft.



WARNING: Do not rely solely upon the display of traffic information to accurately depict all of the traffic within range of the aircraft. Due to lack of equipment, poor signal reception, and/or inaccurate information from aircraft or ground stations, traffic may be present that is not represented on the display.

The Traffic Information Service (TIS-A) provides traffic advisory information to non-TAS/TCAS-equipped aircraft. TIS-A is a ground-based service providing the relative locations of all ATCRBS (Air Traffic Control Radar Beacon System) Mode-A and Mode-C transponder equipped aircraft within a specified service volume. The TIS-A ground sensor uses real-time track reports to generate traffic notification. The G3X Touch displays TIS-A traffic information on the Navigation Map. Surveillance data includes all transponder-equipped aircraft within the coverage volume. The G3X Touch displays up to eight traffic targets within a 7.5-nm radius, from 3,000 feet below, to 3,500 feet above the requesting aircraft.

TIS-A VS. TAS/TCAS

The main difference between the Traffic Information System (TIS-A) and Traffic Advisory (TAS) or Traffic Collision Avoidance Systems (TCAS) is the source of surveillance data. TAS/TCAS uses an airborne interrogator with a half-second update rate, while TIS-A utilizes the terminal Mode-S ground interrogator and accompanying data link to provide a five-second update rate. TIS-A and TAS/TCAS have similar ranges.

TIS-A LIMITATIONS

TIS-A relies on surveillance of the Mode-S radar system, which is a “secondary surveillance” radar system similar to that used by ATCRBS. Many limitations are inherent in secondary radar surveillance. Information provided by TIS-A is neither better nor more accurate than the information used by ATC. TIS-A is intended only to assist in visual acquisition of other aircraft in visual meteorological conditions (VMC). While TIS-A is a useful aid for visual traffic avoidance, system limitations must be considered to ensure proper use. No recommended avoidance maneuvers are given, nor authorized, as a direct result of a TIS-A intruder display or TIS-A advisory.

- TIS-A operation may be intermittent during turns or other maneuvering.
- TIS-A is dependent on two-way, line-of-sight communications between the aircraft and the Mode-S radar antenna. Whenever the structure of the aircraft comes between the transponder antenna and the ground-based radar antenna, the signal may be temporarily interrupted.



NOTE: Refer to the *TIS-A Limitations* section of the *Aeronautical Information Manual (AIM)* for a more comprehensive explanation of limitations and anomalies associated with TIS-A.



NOTE: TIS-A is unavailable at low altitudes in many areas of the United States. This is often the case in mountainous regions.



NOTE: Garmin is not responsible for Mode S geographical coverage. Operation of the ground stations is the responsibility of the FAA. Refer to the *AIM* for a Terminal Mode S radar site map.

TIS-A information is collected during a single radar sweep. Collected information is then sent through the Mode S uplink on the next radar sweep. Because of this, the surveillance information is approximately five seconds old. TIS-A ground station tracking software uses prediction algorithms to compensate for this delay. These algorithms use track history data to calculate expected intruder positions consistent with the time of display. Occasionally, aircraft maneuvering may cause variations in this calculation and create slight errors on the Map Page which affect relative bearing information and the target track vector and may delay display of the intruder information. However, intruder distance and altitude typically remain relatively accurate and may be used to assist in spotting traffic. The following errors are common examples:

- When the client or intruder aircraft maneuvers excessively or abruptly, the tracking algorithm may report incorrect horizontal position until the maneuvering aircraft stabilizes.
- When a rapidly closing intruder is on a course that intercepts the client aircraft course at a shallow angle (either overtaking or head-on) and either aircraft abruptly changes course within 0.25 nm, TIS-A may display the intruder aircraft on the incorrect side of the client aircraft.

These are rare occurrences and are typically resolved within a few radar sweeps once the client/intruder aircraft course stabilizes.

Pilots using TIS-A can provide valuable assistance in the correction of malfunctions by reporting observations of undesirable performance. Reports should identify the time of observation, location, type and identity of the aircraft, and describe the condition observed. Reports should also include the type of transponder and transponder software version. Since TIS-A performance is monitored by maintenance personnel, not ATC, malfunctions should be reported in the following ways:

- By telephone to the nearest Flight Service Station (FSS) facility
- By FAA Form 8000-7, Safety Improvement Report (postage-paid card can be obtained at FAA FSSs, General Aviation District Offices, Flight Standards District Offices, and General Aviation Fixed Base Operators)

- System Overview
- Flight Instruments
- EIS
- CNS Interface
- GPS Navigation
- Flight Planning
- Hazard Avoidance
- Additional Features
- AFCS
- Annun/Alerts
- Appendix**
- Index

Blank Page

APPENDIX F: ABNORMAL OPERATION

LOSS OF GPS POSITION

When the G3X Touch loses the GPS signal for any reason, the following will occur:

- A red 'X' will appear over the airplane icon on the map.
- Any GPS dependent data fields will not be available.



GPS Signal Lost

HAZARD DISPLAY WITH LOSS OF GPS POSITION

If the Terrain Page doesn't have at least a 3D fix (i.e. altitude unknown), a Red X will be displayed.



Terrain Page Red X (Split-Screen)

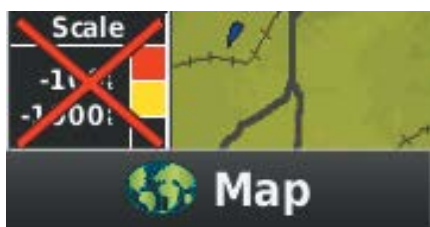

Map Page Red X (Terrain) (Split-Screen)

G3X TOUCH SYSTEM FAILURE ANNUNCIATIONS

When an LRU or an LRU function fails, a large red 'X' is typically displayed over the instrument(s) or data experiencing the failure. After starting the system, certain instruments remain invalid as equipment begins to initialize. All instruments should be operational within one minute of starting the system. If any instrument remains flagged, the G3X Touch should be serviced.



NOTE: Refer to the Pilot's Operating Handbook for additional information regarding pilot responses to these annunciations.



G3X Touch System Failure Annunciations

UNUSUAL ATTITUDES

The Attitude Indicator includes permanent red warning chevrons to indicate extreme pitch angles. A series of downward-pointing chevrons appear at 50° above the horizon line, and upward-pointing chevrons at 30° below the horizon line.

By default, the PFD will also declutter non-essential information when the G3X Touch detects unusual attitude. The declutter is triggered if the aircraft exceeds 30° nose up, OR 20° nose down, OR 65° of bank in either direction. This can be disabled in the G3X Touch Configuration Mode; refer to the Installation Manual for more information.

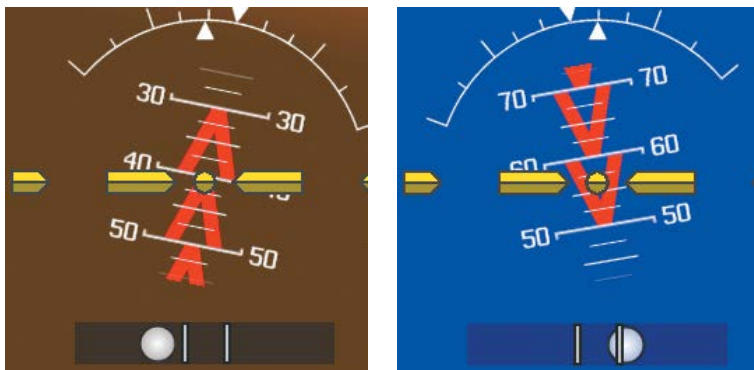

Pitch Attitude Warnings

REVERSIONARY MODE (FULL-SCREEN)

In the event of a display failure, the G3X Touch System automatically switches to reversionary (backup) mode. In reversionary mode, the information is presented on the remaining display in the split-screen configuration.



G3X Touch Full-Screen Reversionary Mode (Failed PFD)

The G3X Touch will revert to showing ADAHRS data from a standby flight display (such as a Garmin G5 or GI 275 Electronic Flight Instrument) if no data is available from a dedicated ADAHRS unit.

AFCS REVERSIONARY MODE

In a two display system, in the event of a PFD failure, the MFD goes into reversionary mode, and the autopilot is disengaged. If the MFD fails, the PFD goes into reversionary mode and the autopilot continues to function.

In a GMC 507 installation, in the event of display failure(s), basic autopilot functionality remains as long as a ADAHRS unit is still available. The FD is no longer available, but LVL, AP, ALT, and YD are available.

FAILURE OF THE EXTERNAL GPS NAVIGATION SOURCE

If the PFD has automatically reverted to using its own internal GPS navigation source due to unavailability of external GPS navigation data, 'REV' is displayed in the lower left quadrant of the HSI and 'VFR' is displayed in the lower right quadrant. In addition, a "Using internal GPS flight plan for navigation" system message is displayed.

SYNTHETIC VISION TROUBLESHOOTING

Synthetic Vision is intended to be used with traditional attitude, heading, obstacle, terrain, and traffic inputs (in most areas). Synthetic Vision is disabled when valid attitude or heading data is not available for the display. In case of invalid Synthetic Vision data, the PFD display reverts to the standard blue-over-brown attitude display.

Synthetic Vision becomes disabled without the following data resources:

- Attitude data
- Heading data
- GPS position data
- Terrain data
- The position of the aircraft exceeds the range of the terrain database

REVERSIONARY MODE WITH SYNTHETIC VISION

Synthetic Vision can be displayed on the remaining display(s) in Reversionary Mode. If it is enabled when the system switches to Reversionary Mode, Synthetic Vision may take up to 30 seconds to display. The standard display will be shown in the interim.

EMERGENCY PAGE

The Emergency Page provides helpful information to enhance situational awareness in the event of an in-flight emergency. This page includes several shortcuts to aid a pilot during an emergency including:

Squawk 7700 Button (Optional)*

Touch to quickly enter 7700 on a configured and connected transponder.

Tune COM 121.500 Button

Touch to quickly tune the standby frequency of a connected COM radio to 121.500.

Best Glide Airport**

Touch to quickly tune the Best Glide Airport tower/CTAF frequency.

Emergency Checklist Button (Optional)

Touch to quickly access the emergency checklist.

Smart Glide Button (Optional)

Touch to activate Smart Glide. Refer to the following section for more information on Smart Glide emergency operations.

*For the Squawk 7700 Button to appear on the G3X Touch, the transponder must be wired to the G3X Touch and GSU and the G3X Touch must be configured as the transponder controller.

**The Best Glide Airport is determined by the GTN™ based on the configured runway surface requirements and prioritized based on METAR reported flight rules (MVFR or better), higher arrival estimated altitude (AGL), and longer runway. Weather information affects prioritization only if the aircraft is equipped for weather data and the weather information is current.

System Overview

Flight Instruments

EIS

CNS Interface

GPS Navigation

Flight Planning

Hazard Avoidance

Additional Features

AFCS

Annun/Alerts

Appendix

Index



Emergency Page (without Smart Glide)



Emergency Page (with Smart Glide)

Accessing the Emergency Page:

From the Main Menu, touch **Emergency**.

Or:

Press and hold the **NRST** Key for two seconds.

Or:

Touch the **Emergency** Data Bar Button (if displayed).

(Refer to the following procedure to display the Emergency button on the Data Bar.)

Displaying the Emergency Button on the Data Bar:

- 1) Press the **MENU** Key twice.
- 2) Touch **Setup** > **Data Bar** > **Data Fields**.
- 3) Touch one of the Data Bar fields.
- 4) Touch **Emergency** from the list.

SMART GLIDE™ EMERGENCY OPERATIONS



NOTE: Smart Glide is only supported when the G3X Touch is installed with a GTN™ Xi running software version 20.22 or later.



NOTE: This section is a general overview of Smart Glide as it pertains to the G3X Touch. For more information about Smart Glide operation refer to the GTN Xi Pilot's Guide.

Smart Glide is designed to assist the pilot by enhancing situational awareness and providing helpful automation during an emergency inoperative engine event. The Smart Glide features referenced here are driven by the GTN Xi's external navigator.

Upon activation, Smart Glide assists the pilot with three critical components of a safe recovery from an engine failure:

- When equipped with a GFC 500 autopilot, the autopilot provides vertical and lateral guidance:
 - IAS mode with configured Best Glide airspeed reference
 - GPS mode with guidance to the destination airport

- Identifies and provides navigation guidance, as well as flight director guidance to a suitable landing location (if one is available)
- Provides quick access to relevant communication channels and emergency checklists

ACTIVATING SMART GLIDE



NOTE: *Smart Glide is armed, meaning it is available for activation, after passing through 1,000 feet above ground level (AGL) after takeoff. Up until that point Smart Glide cannot be armed. Smart Glide remains armed and available for use throughout the remainder of the flight until the aircraft descends below 200 feet AGL. The **Smart Glide Button** is subdued when Smart Glide is not armed.*

Activating Smart Glide:

Press and hold the **Direct-To** Key for two seconds.

Or:

From the Main Menu, touch **Emergency > Smart Glide**.

Or:

Touch the **Emergency Data Bar Button** (if displayed) > **Smart Glide**.
(Refer to previous section to display the **Emergency Data Bar button**.)

Or:

Press the optional Smart Glide discrete switch (if equipped).

*Note: If the Smart Glide Discrete Switch is installed, the GTN **Direct-To** Switch will not activate Smart Glide. The G3X Touch **Direct-To** Switch will activate Smart Glide with or without the Smart Glide discrete switch installed.*

- System Overview
- Flight Instruments
- EIS
- CNS Interface
- GPS Navigation
- Flight Planning
- Hazard Avoidance
- Additional Features
- AFCs
- Annun/Alerts
- Appendix
- Index

Emergency

Squawk 7700 Tune COM 121.500

Activate Emergency Mode

Smart Glide

Emergency Mode Status

No Emergency Mode Active

Best Glide Airport

◆ **KMKC** **133.300**
▶ Charles B Wheeler Downtown Tower

Back Emergency Checklist

Touch to Activate Smart Glide

Selected Best Glide Airport: Upon Smart Glide activation, navigation guidance is provided to this waypoint.

Tower, CTAF, or Unicom (based on the airport's primary frequency) Frequency for Best Glide Airport: Upon Smart Glide activation, the frequency is automatically tuned in the Standby COM.

Emergency Page

When Smart Glide is active and the Emergency Data Bar button is not displayed, the Status Bar displays a **Glide** button. Touch **Glide** to display the Emergency Page.

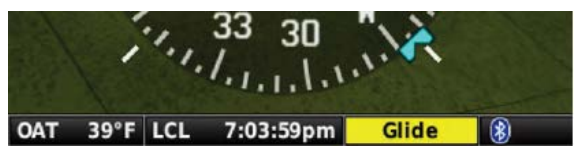

Shortcut To Emergency Page

When Smart Glide is active, the **Glide** button replaces the Message (**MSG**) button on the Data Bar. If a message appears that would cause the **MSG** button to flash, the **Glide** button is replaced with the **MSG** button until the pilot views the message.



Glide Button

AUTOPILOT OPERATION UPON SMART GLIDE ACTIVATION

The GFC 500 autopilot engages servos when the aircraft is more than 2 nm from the destination airport. Coupling will not occur if less than 2 nm; however, the autopilot will remain coupled if servos are already engaged. Flight director modes activate as follows:

- ROL mode (no airport in range) or GPS mode (airport in range)
- IAS (regardless of airport/no airport in range)

SMART GLIDE FUNCTIONALITY

Smart Glide functionality changes based on whether or not a suitable destination airport is within the estimated glide range:

Suitable Airport Within Glide Range	No Suitable Airport Within Glide Range
<ul style="list-style-type: none"> Replaces existing flight plan with a direct glide route to the destination airport 	<ul style="list-style-type: none"> Indicates the configured best glide speed*
<ul style="list-style-type: none"> Triggers autopilot flight director modes to target configured best glide speed and follow the Smart Glide guidance to the destination airport** 	<ul style="list-style-type: none"> Triggers autopilot flight director modes to target configured best glide speed and level the wings**
<ul style="list-style-type: none"> Alerts pilot if glide destination falls outside the Smart Glide Range Ring with the aural alert "Airport out of range" 	<ul style="list-style-type: none"> The aural alert "No airports within glide range" is played
<ul style="list-style-type: none"> Allows direct tuning of emergency transponder code 7700 from the Emergency Page*** 	<ul style="list-style-type: none"> The alert message 'No Airport - Find Alternate Landing Area' is displayed on the Emergency Page
<ul style="list-style-type: none"> Tunes standby COM to destination Tower, CTAF, or Unicom frequency 	<ul style="list-style-type: none"> Allows direct tuning of the emergency transponder code 7700 from the Emergency Page***
<ul style="list-style-type: none"> At Smart Glide engagement, provides an audible annunciation of bearing and distance to the destination airport in the form of "Airport 'X' o'clock, 'X' miles". 	<ul style="list-style-type: none"> Tunes standby COM to emergency frequency 121.500

Suitable Airport Within Glide Range	No Suitable Airport Within Glide Range
<ul style="list-style-type: none"> Approximately 4 NM from the destination airport the aural alert "Approaching airport" is played 	<ul style="list-style-type: none"> Provides altitude voice callouts for 2,000 and 1,000 ft
<ul style="list-style-type: none"> Approximately 2 NM from the destination airport the aural alert "Maneuver and Land. Airport 'X' o'clock, 2 miles" is played 	
<ul style="list-style-type: none"> Approximately 10 seconds after the aircraft is 2 NM from the destination airport, the aural alert "Disconnect Autopilot" is played**** 	

* The configured best glide speed should always be set to the POH/AFM recommended glide speed at the highest gross weight (most limiting case).

** Requires a GFC 500 autopilot.

*** Requires a compatible transponder. If the transponder is controlled by the G3X Touch, the Squawk 7700 button is on the G3X Touch Emergency Page only. If the transponder is controlled by the GTN, the Squawk 7700 button is on the GTN Emergency Page only. If this is the case, the transponder can not be tuned from the G3X Touch.

**** The "Disconnect Autopilot" aural alert will not play if the aircraft has enough altitude to complete a turn back to the airport with an arrival of greater than 2,000 ft AGL.

Smart Glide Operation Upon Activation



NOTE: When a CTAF or Tower frequency cannot be identified for the selected airport, the standby frequency is automatically tuned to 121.500.



CAUTION: During an emergency glide (with a GFC 500 autopilot coupled), up to 30 degrees of bank may be reached when initiating a turn to get on course.



Smart Glide Active - Airport Within Range



NOTE: If desired, the pilot may adjust the airspeed using the pitch wheel.

AIRPORT WITHIN RANGE

The GTN Xi navigates the aircraft to the center of the destination airport. Approximately 4 NM from the destination airport the aural alert "Approaching Airport" is played. At approximately 2 NM from the destination airport the aural alert "Maneuver and Land. Airport 'X' o'clock, 2 Miles" is played. Approximately 10 seconds after the aircraft is 2 NM from the destination airport the aural alert "Disconnect Autopilot" is played.



NOTE: The "Disconnect Autopilot" aural will not play if the aircraft has enough altitude to complete a turn back to the field with an arrival of greater than 2,000 ft AGL.



CAUTION: At 2 NM from the destination airport (regardless of altitude AGL), Smart Glide provides the latest appropriate time for the pilot to take control of the aircraft by issuing an aural "Maneuver and Land" alert. It is the pilot's responsibility to disengage the autopilot and safely land the aircraft.

The GTN Xi monitors the performance of the descent throughout the glide to the airport environment. If the destination airport falls out of the glide range, the aural alert 'Airport Out of Range' is played. The GTN Xi will attempt to establish a new destination airport, if a suitable airport can be located.

Selecting an Alternate Airport:

Selection of an alternate airport is accomplished using the GTN Xi only. Refer to the GTN Xi Pilot's Guide for more information.

AIRPORT NOT WITHIN RANGE

When the GTN Xi determines there is not a suitable airport within glide range, the alert message 'No Airport - Find Alternate Landing Area' is displayed on the Emergency Page and the aural alert "No Airports Within Glide Range" is played. When the GFC 500 is installed, the flight director modes are ROL with a wings level roll attitude and IAS with a configured best glide speed reference. The autopilot automatically engages and follows the Smart Glide flight director guidance.



**Airport Not Within Range
(Smart Glide Not Active)**

**Airport Not Within Range
(Smart Glide Active)**

System Overview

Flight Instruments

EIS

CNS Interface

GPS Navigation

Flight Planning

Hazard Avoidance

Additional Features

AFCs

Annun/Alerts

Appendix

Index

When determining if an airport is within range, the system uses the configured Sink Rate at V_G value. When under partial power, range will be greater than expected by the system. The system monitors for suitable runways that may come into glide range; if an airport comes into glide range, the GTN Xi provides that airport as a Smart Glide option in the 'Alternate Airports' List on the GTN Xi for selection by the pilot. The G3X Touch does not allow for selection of an alternate airport or modification of the flight plan. The flight director and autopilot remain engaged until pilot action is taken.

GLIDE RANGE RING

The Glide Range Ring is displayed on the G3X Touch moving map when the pilot configures it 'ON' in the G3X Touch Map Settings. Under normal conditions the Glide Range Ring is displayed in cyan and is based on the configured glide ratio, terrain, obstacles, and winds. Upon Smart Glide activation, the G3X Touch begins to measure the actual real-time glide ratio and updates the range ring accordingly. This is indicated by a change in the range ring color from cyan to yellow. If any aircraft configuration changes are made (e.g., flaps, gear), it may take up to 30 seconds for the G3X Touch to determine the new glide ratio. Refer to the GTN Xi Pilot's Guide for more information about the Glide Range Ring operation with Smart Glide.

CANCELLING SMART GLIDE

In the event engine power is restored at any point, the pilot may cancel the emergency glide by touching **Cancel Glide**. The flight director will remain engaged in the previously selected lateral and vertical modes. If in GPS mode, the lateral mode will revert to ROL. The autopilot will remain engaged.

Canceling Smart Glide:











From the Emergency Page, touch **Cancel Glide**.

Or:







Use the Smart Glide Discrete Switch (if installed).

APPENDIX G: DISPLAY SYMBOLS

VFR SYMBOLS

Item	Symbol
Unknown	
Non-towered, Non-serviced	
Towered, Non-serviced	
Non-towered, Serviced	
Towered, Serviced	
Soft Surface, Non-serviced	
Soft Surface, Serviced	
Soft Surface, Private	
Paved, Private	
Seaplane Base	
Heliport	

Americas/Pacific Database Airports

Item	Symbol
Civilian, Non-serviced	
Military, Non-serviced	
Civilian, Serviced	
Military, Serviced	
Civilian, Soft/Unknown Surface, Non-serviced	
Civilian, Soft/Unknown Surface, Serviced	

Atlantic Database Airports

- System Overview
- Flight Instruments
- EIS
- CNS Interface
- GPS Navigation
- Flight Planning
- Hazard Avoidance
- Additional Features
- AFCS
- Annun/Alerts
- Appendix
- Index

Item	Symbol
Intersection	
Visual Reporting Point	
LOM (compass locator at outer marker)	
NDB (non-directional radio beacon)	
VOR	
VOR/DME	
ILS/DME or DME only	
VORTAC	
TACAN	

Nav aids

Item	Symbol
Interstate Highway	
US Highway	
State Highway	
National Highway	
Small City	
Medium City	
Large City	

Miscellaneous

IFR SYMBOLS

Item	Symbol
VFR, Soft/unknown Surface, Non-serviced	
VFR, Soft/unknown Surface, Serviced	

Atlantic Database Airports

Item	Symbol
Low-Altitude	
High-Altitude	

Airways

- System Overview
- Flight Instruments
- EIS
- CNS Interface
- GPS Navigation
- Flight Planning
- Hazard Avoidance
- Additional Features
- AFCS
- Annun/Alerts
- Appendix
- Index

Item	Symbol	Item	Symbol
Unknown		Intersection	
VFR Airport, Non-serviced		LOM (compass locator at outer marker)	
IFR Airport, Non-serviced		NDB (non-directional radio beacon)	
VFR Airport, Serviced		VOR	
IFR Airport, Serviced		VOR/DME	
VFR, Soft Surface, Non-serviced		ILS/DME or DME Only	
VFR, Soft Surface, Serviced		VORTAC	
VFR, Soft Surface, Private		TACAN	
VFR, Paved, Private		Nav aids	
VFR Seaplane Base			
VFR Heliport			

Americas/Pacific Database Airports

AIRSPACE SYMBOLS



- System Overview
- Flight Instruments
- EIS
- CNS Interface
- GPS Navigation
- Flight Planning
- Hazard Avoidance
- Additional Features
- AFCs
- Annun/Alerts
- Appendix
- Index

Item	Symbol
Class B, Class E, CTA	
Class A, Class C, TMA	
Class D	
Mode C Veil	
TRSA	
MOA	
Danger, Alert, or Training Area	
Restricted, Prohibited, or Warning Area	
Radar Area	
ATZ, TIZ	
MATZ	
ADIZ	
Misc/Unknown	

VFR Americas/Pacific Database

Item	Symbol
Class B, Class E, CTA	
Class A, Class C, TMA, TRSA	
Class D	
MOA	
Danger, Alert, or Training Area	
Restricted, Prohibited, or Warning Area	
Radar Area	
ATZ, TIZ	
Misc/Unknown	

IFR Americas/Pacific Database

Item	Symbol
Danger or Alert Area	
Restricted, Prohibited, or Warning Area	
Training Area	

VFR Atlantic Database Exceptions

Item	Symbol
Training Area	

IFR Atlantic Database Exceptions

- System Overview
- Flight Instruments
- EIS
- CNS Interface
- GPS Navigation
- Flight Planning
- Hazard Avoidance
- Additional Features
- AFCS
- Annun/Alerts
- Appendix**
- Index

Blank Page

APPENDIX H: GLOSSARY

ADIZ	Air Defense Identification Zone
ADS-B	Automatic Dependant Surveillance-Broadcast
ADS-B In	Ability to receive ADS-B information from other aircraft and Ground Based Transceivers (GBTs)
ADS-B Out	Ability to transmit ADS-B data on 1090 ES or 978 MHz
ADS-B Participating Aircraft	An aircraft that has both ADS-B In and ADS-B Out capabilities.
ADS-R	Automatic Dependent Surveillance-Rebroadcast
AGL	Above Ground Level
AIM	Airman's Information Manual
AIRMET	Airman's Meteorological Information
AP	Autopilot
APT	airport
ASPC	airspace
ARTCC	Air Route Traffic Control Center
ASOS	Automated Surface Observing System
ATC	Air Traffic Control
ATIS	Automatic Terminal Information Service
AWOS	Automated Weather Observing System
Bearing	The compass direction from the present position to a destination waypoint.
°C	degrees Celsius
Calibrated Airspeed	Indicated airspeed corrected for installation and instrument errors.
cm	centimeter
COM	communication radio

System Overview	Course	The line between two points to be followed by the aircraft.
Flight Instruments	Course to Steer	The recommended direction to steer in order to reduce course error or stay on course. Provides the most efficient heading to get back to the desired course and proceed along the flight plan.
EIS	Crosstrack Error	The distance the aircraft is off a desired course in either direction, left or right.
	CTS	Course to Steer
CNS Interface	dBZ	decibels 'Z' (radar return)
	deg	degree
GPS Navigation	Desired Track	The desired course between the active "from" and "to" waypoints.
	DIS	distance
Flight Planning	Distance	The 'great circle' distance from the present position to a destination waypoint.
Hazard Avoidance	DTK	Desired Track
Additional Features	Enroute Safe Altitude	The recommended minimum altitude within ten miles left or right of the desired course on an active flight plan or direct-to.
	ENT	enter
AFCs	ESA	Enroute Safe Altitude
	Estimated Time of Arrival	The estimated time at which the aircraft should reach the destination waypoint, based upon current speed and track.
Annun/Alerts	Estimated Time Enroute	The estimated time it takes to reach the destination waypoint from the present position, based upon current ground speed.
Appendix	ETA	Estimated Time of Arrival
	ETE	Estimated Time Enroute
Index	°F	degrees Fahrenheit
	FAA	Federal Aviation Administration

FAF	Final Approach Fix	System Overview
FCC	Federal Communication Commission	Flight Instruments
FPL	flight plan	EIS
fpm	feet per minute	CNS Interface
FSS	Flight Service Station	GPS Navigation
ft	foot/feet	Flight Planning
gal	gallon(s)	Hazard Avoidance
geodetic altitude	GPS calculated altitude	Additional Features
Glide Ratio, G/R	The ratio of horizontal distance (distance traveled over the ground) to vertical distance traveled (nn.n:1).	AFCS
GND	ground	Annun/Alerts
gph	gallons per hour	Appendix
GPS	Global Positioning System	Index
Grid MORA	Grid Minimum Off-Route Altitude; one degree latitude by one degree longitude in size and clears the highest elevation reference point in the grid by 1000 feet for all areas of the grid	
Groundspeed	The velocity the aircraft is travelling relative to a ground position.	
Ground-Based Transceiver	Provides ADS-R, TIS-B and FIS-B broadcasts to ADS-B participating aircraft.	
Ground Track	see Track	
GS	Ground speed	
Heading	The direction an aircraft is pointed, based upon indications from a magnetic compass or a properly set directional gyro.	
Hg	mercury	
hPa	hectopascal	
hr	hour	
HSI	Horizontal Situation Indicator	
Hz	Hertz	

System Overview	IAF	Initial Approach Fix
	IAT	Indicated Air Temperature
	ICAO	International Civil Aviation Organization
Flight Instruments	IFR	Instrument Flight Rules
	ILS	Instrument Landing System
EIS	IMC	Instrument Meteorological Conditions
	in	inch
CNS Interface	Indicated	Information provided by properly calibrated and set instrumentation on the aircraft panel.
	in HG	inches of mercury
GPS Navigation	kg	kilogram
	kHz	kilohertz
Flight Planning	km	kilometer
	kt	knot
Hazard Avoidance	LAT	latitude
	lb	pound
Additional Features	Leg	The portion of a flight plan between two waypoints.
	LON	longitude
AFCS	m	meter
	MAP	Missed Approach Point
Annun/Alerts	METAR	Meteorological Aviation Routine
	MHz	megahertz
Appendix	Minimum Safe Altitude	Uses Grid MORAs to determine a safe altitude within ten miles of the aircraft present position.
	MOA	Military Operations Area
Index	MSA	Minimum Safe Altitude
	MSL	Mean Sea Level

NAVAID	NAVigation AID
NDB	Non-directional Beacon
NEXRAD	Next Generation Radar
nm	nautical mile(s)
NRST	nearest
OAT	Outside Air Temperature
OBS	Omni Bearing Selector
psi	pounds per square inch
QTY	quantity
rpm	revolutions per minute
SBAS	Satellite-Based Augmentation System
SD	Secure Digital
sec	second(s)
SIGMET	Significant Meteorological Information
TACAN	Tactical Air Navigation System
TAF	Terminal Aerodrome Forecast
TAS	True Airspeed
TER	terrain
TFR	Temporary Flight Restriction
TOPO	topographic
TIS-A	Traffic Information Service
TIS-B	Traffic Information Service-Broadcast

System Overview

Flight Instruments

EIS

CNS Interface

GPS Navigation

Flight Planning

Hazard Avoidance

Additional Features

AFCs

Annun/Alerts

Appendix

Index

System Overview	Track	Direction of aircraft movement relative to a ground position; also 'Ground Track'
	TRSA	Terminal Radar Service Area
Flight Instruments	UTC	Coordinated Universal Time
	VFR	Visual Flight Rules
EIS	VHF	Very High Frequency
	VNAV	vertical navigation
CNS Interface	VOL	volume
	VOR	VHF Omni-directional Range
GPS Navigation	VORTAC	very high frequency omnidirectional range station and tactical air navigation
	VSI	Vertical Speed Indicator
Flight Planning	VSR	Vertical Speed Required
	VTF	vector to final
Hazard Avoidance	WAAS	Wide Area Augmentation System
	WPT	waypoint
Additional Features	WX	weather
AFCS		
Annun/Alerts		
Appendix		
Index		

APPENDIX I: LICENSE AGREEMENT AND WARRANTY

CONTACT GARMIN

Contact Garmin if you have any questions while using your G3X Touch. Contact Garmin Product Support at www.fly.garmin.com.

SOFTWARE LICENSE AGREEMENT

BY USING THE DEVICE, COMPONENT OR SYSTEM MANUFACTURED OR SOLD BY GARMIN ("THE GARMIN PRODUCT"), YOU AGREE TO BE BOUND BY THE TERMS AND CONDITIONS OF THE FOLLOWING SOFTWARE LICENSE AGREEMENT. PLEASE READ THIS AGREEMENT CAREFULLY. Garmin Ltd. and its subsidiaries ("Garmin") grants you a limited license to use the software embedded in the Garmin Product (the "Software") in binary executable form in the normal operation of the Garmin Product. Title, ownership rights, and intellectual property rights in and to the Software remain with Garmin and/or its third-party providers. You acknowledge the Software is the property of Garmin and/or its third-party providers and is protected under the United States of America copyright laws and international copyright treaties. You further acknowledge the structure, organization, and code of the Software are valuable trade secrets of Garmin and/or its third-party providers and the Software in source code form remains a valuable trade secret of Garmin and/or its third-party providers. You agree not to reproduce, decompile, disassemble, modify, reverse assemble, reverse engineer, or reduce to human readable form the Software or any part thereof or create any derivative works based on the Software. You agree not to export or re-export the Software to any country in violation of the export control laws of the United States of America.

LIMITED WARRANTY FOR G3X TOUCH PRODUCTS

Garmin G3X Touch LRUs GAD 29B/29D, GAP 26, GDU 37X, GDU 45X/46X/470, GEA 24, GMC 305, GMC 307, GMU 22, GMU 44, GPS 20A, GSA 28, GSU 25/25B, GSU 73, GTP 59, & GTR 20 are warranted to be free from defects in materials or workmanship for two years from the date of purchase. Within the applicable period, Garmin will, at its sole option, repair or replace any components that fail in normal use. Such repairs or replacement will be made at no charge to the customer for parts or labor, provided the customer shall be responsible for any transportation cost. This warranty does not apply to: (i) cosmetic damage, such as scratches, nicks and dents; (ii) consumable parts, such as batteries, unless product damage has occurred due to a defect in materials or workmanship; (iii) damage caused by accident, abuse, misuse, water, flood, fire, or other acts of nature or external causes; (iv) damage caused by service performed by anyone who is not an authorized service provider of Garmin; or (v) damage to a product that has been modified or altered without the written permission of Garmin. In addition, Garmin reserves the right to refuse warranty claims against products or services that are obtained and/or used in contravention of the laws of any country.

THE WARRANTIES AND REMEDIES CONTAINED HEREIN ARE EXCLUSIVE AND IN LIEU OF ALL OTHER WARRANTIES, WHETHER EXPRESS, IMPLIED OR STATUTORY, INCLUDING ANY LIABILITY ARISING UNDER ANY WARRANTY OF MERCHANTABILITY OR FITNESS FOR A PARTICULAR PURPOSE, STATUTORY OR OTHERWISE. THIS WARRANTY GIVES YOU SPECIFIC LEGAL RIGHTS, WHICH MAY VARY FROM STATE TO STATE.

IN NO EVENT SHALL GARMIN BE LIABLE FOR ANY INCIDENTAL, SPECIAL, INDIRECT OR CONSEQUENTIAL DAMAGES, WHETHER RESULTING FROM THE USE, MISUSE OR INABILITY TO USE THE PRODUCT OR FROM DEFECTS IN THE PRODUCT. SOME STATES DO NOT ALLOW THE EXCLUSION OF INCIDENTAL OR CONSEQUENTIAL DAMAGES, SO THE ABOVE LIMITATIONS MAY NOT APPLY TO YOU.

Garmin retains the exclusive right to repair or replace (with a new or newly-overhauled replacement product) the product or software or offer a full refund of the purchase price at its sole discretion. SUCH REMEDY SHALL BE YOUR SOLE AND EXCLUSIVE REMEDY FOR ANY BREACH OF WARRANTY.

Online Auction Purchases: Products purchased through online auctions are not eligible for warranty coverage. Online auction confirmations are not accepted for warranty verification. To obtain warranty service, an original or copy of the sales receipt from the original retailer is required. Garmin will not replace missing components from any package purchased through an online auction.

International Purchases: A separate warranty may be provided by international distributors for devices purchased outside the United States depending on the country. If applicable, this warranty is provided by the local in-country distributor and this distributor provides local service for your device. Distributor warranties are only valid in the area of intended distribution. Devices purchased in the United States or Canada must be returned to the Garmin service center in the United Kingdom, the United States, Canada, or Taiwan for service.

Garmin International, Inc.

1200 East 151st Street

Olathe, Kansas 66062, U.S.A.

Garmin (Europe) Ltd.

Liberty House, Hounsdown Business Park

Southampton, Hampshire SO40 9LR, U.K.

Refer to the G3X Installation Manual for warranty registration instructions.

AOPA AIRPORT DIRECTORY NOTICE

AOPA MEMBERSHIP PUBLICATIONS, INC. AND ITS RELATED ORGANIZATIONS (HEREINAFTER COLLECTIVELY "AOPA") EXPRESSLY DISCLAIM ALL WARRANTIES, WITH RESPECT TO THE AOPA INFORMATION INCLUDED IN THIS DATA, EXPRESS OR IMPLIED, INCLUDING, BUT NOT LIMITED TO, THE IMPLIED WARRANTIES OF MERCHANTABILITY AND FITNESS FOR A PARTICULAR PURPOSE. THE INFORMATION IS PROVIDED "AS IS" AND AOPA DOES NOT WARRANT OR MAKE ANY REPRESENTATIONS REGARDING ITS ACCURACY, RELIABILITY, OR OTHERWISE. UNDER NO CIRCUMSTANCES INCLUDING NEGLIGENCE, SHALL AOPA BE LIABLE FOR ANY INCIDENTAL, SPECIAL OR CONSEQUENTIAL DAMAGES THAT RESULT FROM THE USE OR INABILITY TO USE THE SOFTWARE OR RELATED DOCUMENTATION, EVEN IF AOPA OR AN AOPA AUTHORIZED REPRESENTATIVE HAS BEEN ADVISED OF THE POSSIBILITY OF SUCH DAMAGES. USER AGREES NOT TO SUE AOPA AND, TO THE MAXIMUM EXTENT ALLOWED BY LAW, TO RELEASE AND HOLD HARMLESS AOPA FROM ANY CAUSES OF ACTION, CLAIMS OR LOSSES RELATED TO ANY ACTUAL OR ALLEGED INACCURACIES IN THE INFORMATION ARISING OUT OF GARMIN'S USE OF THE INFORMATION IN THE DATASETS. SOME JURISDICTIONS DO NOT ALLOW THE LIMITATION OR EXCLUSION OF IMPLIED WARRANTIES OR LIABILITY FOR INCIDENTAL OR CONSEQUENTIAL DAMAGES SO THE ABOVE LIMITATIONS OR EXCLUSIONS MAY NOT APPLY TO YOU.

AC-U-KWIK LICENSE AGREEMENT

AC-U-KWIK AND ITS RELATED ORGANIZATIONS (HEREINAFTER COLLECTIVELY "AC-U-KWIK ORGANIZATIONS") EXPRESSLY DISCLAIM ALL WARRANTIES WITH RESPECT TO THE AC-U-KWIK INFORMATION INCLUDED IN THIS DATA, EXPRESS OR IMPLIED, INCLUDING, BUT NOT LIMITED TO, THE IMPLIED WARRANTIES OF MERCHANTABILITY AND FITNESS FOR A PARTICULAR PURPOSE. THE INFORMATION IS PROVIDED "AS IS" AND AC-U-KWIK ORGANIZATIONS DO NOT WARRANT OR MAKE ANY REPRESENTATIONS REGARDING ITS ACCURACY, RELIABILITY, OR OTHERWISE. LICENSEE AGREES NOT TO SUE AC-U-KWIK ORGANIZATIONS AND, TO THE MAXIMUM EXTENT ALLOWED BY LAW, TO RELEASE AND HOLD HARMLESS AC-U-KWIK ORGANIZATIONS FROM ANY CAUSES OF ACTION, CLAIMS OR LOSSES RELATED TO ANY ACTUAL OR ALLEGED INACCURACIES IN THE INFORMATION ARISING OUT OF GARMIN'S USE OF THE INFORMATION IN THE DATASETS. SOME JURISDICTIONS DO NOT ALLOW THE LIMITATION OR EXCLUSION OF IMPLIED WARRANTIES OR LIABILITY FOR INCIDENTAL OR CONSEQUENTIAL DAMAGES SO THE ABOVE LIMITATIONS OR EXCLUSIONS MAY NOT APPLY TO LICENSEE.

SIRIUSXM SATELLITE RADIO SERVICE AGREEMENT

Hardware and required monthly subscription sold separately. USER ACKNOWLEDGES THAT GARMIN HAS NO CONTROL OVER THE TERMS AND REQUIREMENTS OF THE SUBSCRIPTION. COMPATABILITY OF HARDWARE EQUIPMENT WITH THEN-CURRENT SUBSCRIPTION OFFERING OF SERVICE PROVIDER IS ALSO BEYOND GARMIN'S CONTROL. GARMIN SHALL HAVE NO LIABILITY IF CHANGES IN SERVICE PROVIDER'S SUBSCRIPTION OFFERING NEGATIVELY IMPACTS OR RENDERS IMPOSSIBLE THE USE OF PURCHASED GARMIN HARDWARE EQUIPMENT WITH THE SERVICE PROVIDER'S OFFERING IN THE FUTURE. Subscription fee is consumer only. Other fees and taxes, including a one-time activation fee may apply. All programming fees and weather data subject to change. Sirius XM weather data and individual product availability vary by hardware equipment. Reception of the Sirius XM signal may vary depending on location. Subscriptions subject to Customer Agreement included with the Sirius XM Welcome Kit and available at www.siriusxm.com. USER ACKNOWLEDGES THAT GARMIN IS AN INTENDED THIRD PARTY BENEFICIARY OF SUCH CUSTOMER AGREEMENT, AND THAT ALL DISCLAIMERS CONTAINED THEREIN EQUALLY APPLY AS IF SUCH DISCLAIMERS WERE MADE DIRECTLY BY GARMIN. Available only in the 48 contiguous United States.

THE USER AGREES THE SIRIUS XM WEATHER SERVICE OFFERING IS PROVIDED "AS IS", THAT YOUR GARMIN HARDWARE EQUIPMENT ONLY ALLOWS THE DISPLAY OF SUCH SERVICE OFFERING, AND THAT ANY CHANGES BY THE SERVICE PROVIDER MAY INTERFERE WITH THE ABILITY OF YOUR GARMIN HARDWARE EQUIPMENT TO RECEIVE OR DISPLAY SUCH SERVICE OFFERING. FURTHER, SUCH SERVICE OFFERING CONTAINS INFORMATION FURNISHED BY OTHERS WHO ARE NOT UNDER THE CONTROL OF GARMIN, AND THEREFORE THE SERVICE OFFERING IS ACCORDINGLY FURNISHED WITHOUT ANY WARRANTY OF GARMIN, EXPRESS OR IMPLIED, INCLUDING WITHOUT LIMITATION, IMPLIED WARRANTIES OF MERCHANTABILITY AND FITNESS FOR A PARTICULAR PURPOSE.

Contact SiriusXM Satellite Radio by phone at 800.985.9200 to subscribe to XM WX Weather and/or SiriusXM Radio.

WEATHER DATA WARRANTY

THE WEATHER DATA SOFTWARE PRODUCT IS PROVIDED "AS IS." ALL OTHER WARRANTIES, EXPRESSED OR IMPLIED, INCLUDING ANY WARRANTY OF MERCHANTABILITY OR FITNESS FOR A PARTICULAR PURPOSE OR OF NON-INFRINGEMENT ARE HEREBY EXCLUDED.

USER SAFETY

If you use XM Services it is your responsibility to exercise prudent discretion and observe all safety measures required by law and your own common sense. You assume the entire risk related to your use of the Services. XM and Garmin assume no responsibility for accidents resulting from or associated with use of the Services. Your Radio Service includes traffic and weather information, and you acknowledge that such information is not for “safety for life”, but is merely supplemental and advisory in nature, and therefore cannot be relied upon as safety-critical in connection with any aircraft, sea craft or automobile usage. This information is provided “as is” and XM and Garmin disclaim any and all warranties, express and implied, with respect thereto or the transmission or reception thereof. XM and Garmin further do not warrant the accuracy, reliability, completeness or timeliness of the traffic and weather information disclosed on the Radio Service. In no event will XM and Garmin, their data suppliers, service providers, marketing/distribution, software or Internet partners or hardware manufacturers be liable to you or to any third party for any direct, indirect, incidental, consequential, special, exemplary or punitive damages or lost profits resulting from use of or interruptions in the transmission or reception of the Services.

LIMITS ON OUR RESPONSIBILITY

a) DISCLAIMERS.

EXCEPT AS EXPRESSLY PROVIDED HEREIN, WE MAKE NO WARRANTY OR REPRESENTATION, EITHER EXPRESS OR IMPLIED, REGARDING THE RADIO SERVICE. YOUR USE OF THE SERVICE IS AT YOUR SOLE RISK. THE CONTENT AND FUNCTIONALITY OF THE SERVICE IS PROVIDED “AS IS” WITHOUT ANY WARRANTY OF ANY KIND, EXPRESS OR IMPLIED. ALL SUCH WARRANTIES OR REPRESENTATIONS (INCLUDING, WITHOUT LIMITATION, THE IMPLIED WARRANTIES OF MERCHANTABILITY, FITNESS FOR A PARTICULAR PURPOSE, TITLE AND NON-INFRINGEMENT) ARE HEREBY DISCLAIMED.

b) LIMITATIONS OF LIABILITY.

WE ARE NOT RESPONSIBLE FOR ANY SPECIAL, INCIDENTAL, OR CONSEQUENTIAL DAMAGES OR LOSSES RELATING TO THE USE OF THE RADIO SERVICE, WHETHER BASED ON NEGLIGENCE OR OTHERWISE. OUR TOTAL LIABILITY TO YOU AND ANY OTHER PERSONS RECEIVING OUR SERVICES, REGARDLESS OF THE CAUSE, WILL IN NO EVENT EXCEED THE AMOUNTS THAT YOU HAVE PAID TO US FOR THE SERVICE THAT YOU RECEIVED DURING THE SIX (6) MONTH PERIOD IMMEDIATELY PRIOR TO THE SPECIFIC EVENT THAT GAVE RISE TO THE APPLICABLE DAMAGE OR LOSS. THIS ALLOCATION OF RISK IS REFLECTED IN OUR PRICES. YOU MAY HAVE GREATER RIGHTS THAN DESCRIBED ABOVE UNDER YOUR STATE’S LAWS

This product was developed using DAFIF™, a product of the National Geospatial-Intelligence Agency.

This product has not been endorsed or otherwise approved by the National Geospatial-Intelligence Agency, or the United States Department of Defense (10 U.S.C. 425)

- a. Under 10 U.S.C. 456, no civil action may be brought against the United States on the basis of the content of a navigational aid prepared or disseminated by either the former Defense Mapping Agency (DMA), National Imagery and Mapping Agency (NIMA), or the National Geospatial-Intelligence Agency (NGA).
- b. The DAFIF™ product is provided “as is,” and no warranty, express or implied, including, but not limited to the implied warranties of merchantability and fitness for particular purpose or arising by statute or otherwise in law or from a course of dealing or usage in trade, is made by NGA as to the accuracy and functioning of the product.
- c. Neither NGA nor its personnel will be liable for any claims, losses, or damages arising from or connected with the use of this product. The user agrees to hold harmless the United States National Geospatial-Intelligence Agency. The user’s sole and exclusive remedy is to stop using the DAFIF product.

A

Acquiring Satellites 31
 ADS-B 246
 ADS-B In 238
 ADS-B Out 238
 ADS-B participating 238
 ADS-R 239
 Air Data Computer (ADC) 2
 AIRMET 205, 206
 Airport
 Review 153
 Weather 157
 Airspace 140, 162
 Alerts 162
 Selecting and Viewing 162
 Smart 163
 Airspeed Indicator 50
 Airways 150
 Reviewing 151
 Alarms 43, 45
 Alerts 335
 Altimeter 54–59
 Altitude Alerting 58
 Altitude Hold Mode (ALT) 309
 Altitude Reference 308
 AOPA 271
 Approach 182
 Activating Vectors-to-Final 185
 Chart 184
 Loading 183
 Removing 184
 Selecting 183
 Approach Mode 325
 Attitude and Heading Reference System
 (AHRS) 2, 23
 Attitude Indicator 52

Automatic Dependent Surveillance-
 Broadcast 237
 Automatic Dependent Surveillance-
 Rebroadcast 239
 Automatic Reversion 313
 Automatic squelch 101, 103
 Autopilot Disconnect 299
 Auto-Slewing 73

B

Barometric setting, Altimeter 49, 56–57
 Basemap 377
 Bearing/Distance, Measuring 143, 144,
 147
 Bearing source 67
 Bluetooth 284

C

CDI source 65
 Chart Not Available 266, 270
 Cloud Tops 198
 Cloud Tops Forecast 198
 Command Bars 303
 Comparator Window 346
 Compass Arc 135
 Course Deviation Indicator (CDI) 65
 Crew Alerting System (CAS) 90, 94, 95,
 96, 343, 344
 Current Icing Product (CIP) 212

D

Data Bar Fields 34, 351
 Databases 376
 Updating 380
 Data Entry 25–26
 Date & Time 40

- Delete
 - Flight Plans 176, 178
 - Flight Records 361
 - Individual Waypoint 179
- Direct-to 164
 - Cancelling 166
- Display
 - Backlighting 33
 - Overview 14
 - Symbols 405
- E**
- Echo Tops 199
- Emergency Page 395
- Engine Indication System (EIS) 87
- Engine Manifold Pressure 89
- ENG Page 87
- Exhaust Gas Temperature 89
- F**
- Field of View 262
- FIS-B 239
- Flight director (FD) 294
- Flight Information Service-Broadcast 239
- Flight Instruments 47
- Flight Level Change Mode 311
- Flight Log 359
- Flight Plan 167
 - Activation 174
 - Active 169
 - Adding Waypoints 175
 - Approaches 182
 - Copying 178
 - Creation 169
 - Data Fields 168
 - Editing 175
 - Fuel Flow 177
 - Inverting 180
 - Name 176
 - Speed 176
 - Waypoints, Adding 175
- Flight Plan (FPL) Pages 28
- FliteCharts 268
 - Expiration 271
 - Range 266, 271
- FMS Joystick 15
- Freezing Levels 211
- Frequencies 104, 106
- Fuel Calculator 94
- Fuel Flow Indicator 89
- Fuel Pressure Indicator 89
- Fuel Quantity Indicator 89
- Fuel Range Ring 143, 144, 147
- G**
- Garmin Display Unit (GDU) 156
- Garmin Sensor Unit (GSU) 2, 6, 7
- GBT 238
- GDU 370 2, 8
- Glidepath Mode (GP) 315
- Glideslope Mode 316
- GMC 507 6, 7
- GMU 44 3
- GPS Receiver Status 30
- Ground Based Transceivers 238
- GTP 59 2, 3, 4, 5
- H**
- Hazard Display 391

Heading 49
 Heading Line 366
 Heading Select Mode 319
 Heading Strip 73
 Horizontal Situation Indicator (HSI) 49,
 63
 Annunciations 65

I

Icing Forecast 212
 Information Window 67
 Integrated Autopilot
 Alerts 348
 Disengaging 299
 Engaging 299
 Intersections 157
 Inverting, Flight Plan 180

K

Keyboard 46

L

Lean Assist 90
 Legends 192
 License Agreement 417
 Limited Warranty 417
 Line Replaceable Unit (LRU) 1
 Location Formats 43, 385

M

Magnetometer 3
 Main Pages 27, 28
 Map
 Airways 151

Customizing 140
 Detail 149
 Displays 136
 Orientation 137
 Panning 142
 Range 141
 Satellite View 148
 Setup 137
 Symbols 149, 405
 Map Datum 385
 MAP Page
 Defaults 192
 XM Weather 192
 Map Range 141
 Map Symbols 149
 Measuring
 Bearing 147
 Distance 147
 MENU Key 15
 Menus 25
 Navigating 301
 Messages
 Miscellaneous 335, 336
 System 337
 METAR 204
 Flag Color 204

N

Navigation Mode 321–322
 Navigation Source 12, 69
 NDBs 158
 Nearest
 Airport 156
 Airspaces 162
 NDB 158

VORs 159
 Nearest Information 155
 Nearest Type
 Changing 32
 NEXRAD 194, 197
 NRST Key 15

O

OBS Mode 74, 76
 Obstacles 218
 Oil Pressure Indicator 89
 Oil Temperature Indicator 89
 Outside Air Temperature (OAT) 77

P

Pages 27
 Flight Plan (FPL) 28
 MAIN 27, 28
 Panning 142
 PFD
 Annunciations 343
 PIREP 209
 Pitch Hold Mode 306
 Position 32
 Settings 43
 Proximity Waypoints 372

R

Red X 23, 391
 Roll Hold Mode 319
 Runway Extension line 139
 Runway Number 139

S

SafeTaxi 250, 264
 Satellite Information 32
 Satellite View 148
 Secure Digital (SD) Cards 16, 375
 Installing 16
 Selected Altitude 307, 308, 310
 Selected Altitude Capture Mode 307,
 308, 310
 Selected Ground Track 320
 Selected Heading 63, 319
 Settings 33
 SIGMET 206
 SiriusXM 188, 191, 192, 249, 273,
 274, 419
 Smart Airspace 163
 Smart Glide 396
 Sound 40
 Standard Rate Turn Bank Angle Point-
 ers 53
 Storm Cells 203
 Supercooled Large Droplet (SLD) 212
 Surface Pressure 202
 Symbols 149
 Synthetic Vision (SVX) 249
 System
 Annunciations 23
 Date & Time 42, 43
 Functionality 25
 Initialization 16
 Power-up 16
 Settings 33

System ID 380

T

Tachometer (RPM) 89
 TAFs 204
 Takeoff Mode 317
 TAS 387
 TCAS 387
 Temperature Probe 3
 Temporary Flight Restrictions (TFRS)
 208
 Terrain 213, 216
 Alerts 219, 220
 Annunciations 345
 Obstacle Information 218
 Shading 217
 Views 218
 TIS-B 239
 Topography 148
 Track Log 362
 Track Select Mode 320
 Traffic Information Service-Broadcast
 239
 Traffic Information Service (TIS) 222,
 387–388
 Annunciations 225, 345
 Audio Alerts 227
 General Information 387
 Ground Track 228
 Limitations 388
 Traffic Warning Window 227
 Transponder
 Status Box 49
 True Airspeed (TAS) 49, 50

Turbulence Forecast 211

Turn Rate Indicator 49

U

UAT 238
 Universal Access Transceiver 237
 User Waypoints 159
 Creating 159, 160, 162
 Deleting 161
 Editing 161
 Nearest 160
 Renaming 161

V

Vertical Deviation Indicator (VDI) 60
 Vertical Navigation Mode (VNAV) 312
 Vertical Navigation (VNAV)
 Capturing 84
 Configuring 83
 Vertical Speed Indicator (VSI) 59
 Vertical Speed Mode 310
 Vertical Speed Reference 310
 VNAV Target Altitude Capture Mode
 (ALTV) 314
 Voltmeter 89
 VORs 159
 Vspeed Reference 44

W

Warranty 417
 Waypoints 152, 159
 Creating 159, 160, 162
 User 159
 Weather Information 157

Weight & Balance 368
Wind Data 78
Winds Aloft 200

X

XM
 Accessing 191
 XM Satellite Radio 273, 275
X Symbol 217

System
Overview

Flight
Instruments

EIS

CNS
Interface

GPS
Navigation

Flight
Planning

Hazard
Avoidance

Additional
Features

AFCs

Annun/Alerts

Appendix

Index



Garmin International, Inc.
1200 East 151st Street
Olathe, Kansas 66062, U.S.A.
Garmin Product Support: www.fly.garmin.com

Garmin AT, Inc.
2345 Turner Road SE
Salem, OR 97302, U.S.A.
Garmin Product Support: www.fly.garmin.com

Garmin (Europe) Ltd.
Liberty House, Hounslow Business Park
Southampton, Hampshire SO40 9LR U.K.
Garmin Product Support: www.fly.garmin.com

Garmin Würzburg GmbH
Beethovenstrasse 1a
97080 Würzburg, Germany
Garmin Product Support: flygarmin.com

Garmin Corporation
No. 68, Zhongshu 2nd Road
Xizhi District, New Taipei City, Taiwan
Garmin Product Support: www.fly.garmin.com

www.garmin.com

