

GARMIN[®]

FF 350 Plus



Owner's Manual

© 2017 Garmin Ltd. or its subsidiaries

All rights reserved. Under the copyright laws, this manual may not be copied, in whole or in part, without the written consent of Garmin. Garmin reserves the right to change or improve its products and to make changes in the content of this manual without obligation to notify any person or organization of such changes or improvements. Go to www.garmin.com for current updates and supplemental information concerning the use of this product.

Garmin®, Ultrascroll®, and the Garmin logo are trademarks of Garmin Ltd. or its subsidiaries, registered in the USA and other countries. Garmin ClearVü™ is a trademark of Garmin Ltd. or its subsidiaries. These trademarks may not be used without the express permission of Garmin.

Table of Contents

Introduction	1
FF 350 Plus Dimensions	1
Device Overview	1
Keys	1
Contacting Garmin® Product Support	1
Selecting the Transducer Type	1
Adjusting the Backlight	1
Changing the Color Mode	1
Setting the Beeper	1
Panning on the FF 350 Plus	1
Home Screen	2
Customizing the Home Screen	2
Adding the Data Graphs or Temperature Data Graphs Screen	2
Pages Shortcuts	2
Sonar	2
Traditional Sonar	2
Garmin ClearVü Sonar View	2
Split-Screen Frequency	3
Shift-Zoom View	3
Pausing the Sonar	3
Adjusting the Zoom	3
Locking the Screen to the Water Bottom	3
Reducing the Clutter	4
Sonar Frequencies	4
Selecting Frequencies	4
Sonar Gain	4
Setting the Gain Automatically	4
Setting the Gain Manually	4
Adjusting the Range of the Depth Scale	4
Showing and Customizing the Overlay Numbers	4
Sonar Setup	5
Showing and Adjusting the Depth Line	5
Setting the Scroll Speed	5
Sonar Appearance Settings	5
Overlay Numbers	5
Device Configuration	6
FF 350 Plus Settings Menu Tree	6
System Settings	6
System Information	6
My Vessel Settings	6
Setting the Keel Offset	6
Setting the Water Temperature Offset	7
Calibrating a Water Speed Device	7
Alarms Settings	7
System Alarm	7
Sonar Alarms	7
Restoring the Factory Default Settings	7
Appendix	7
Registering Your Device	7
FF 350 Plus Specifications	8
Troubleshooting	8
My device does not turn on	8
My sonar does not work	8
物質宣言	8
Index	9

Introduction

⚠ WARNING

See the *Important Safety and Product Information* guide in the product box for product warnings and other important information.

FF 350 Plus Dimensions

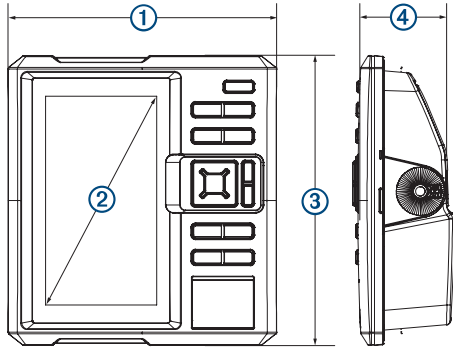

①	176 mm (6.94 in.)
②	178 mm (7 in.)
③	190 mm (7.5 in.)
④	81.8 mm (3.25 in.)

Device Overview



①	Power key
②	Device keys

Keys

	Hold to turn the device on or off. Select to adjust the backlight, adjust the color mode, configure colors, and enable and disable sonar.
CLUTTER	Select to adjust the appearance of clutter on the screen.
ZOOM	Select to adjust the zoom.
GAIN	Select to adjust the gain.
RANGE	Select to adjust the sonar range.
	Select to scroll, highlight options, and move the cursor.
	Select to scroll, highlight options, and move the cursor.
	Select to pause sonar.
	Select to zoom in to a view.
	Select to zoom out of a view.

BACK	Select to return to the previous screen. Hold to return to the home screen.
SELECT	Select to select options and acknowledge messages.
MENU	Select to open the options menu for each page.
PAGE	Select to scroll through the main pages.

Contacting Garmin® Product Support

Go to my.garmin.com for in-country product support contact information.

Selecting the Transducer Type

If you are not using the included transducer, you must set the transducer type to enable the sonar to function optimally. If you are using the included transducer, you do not need to complete these steps.

- 1 Select **Settings > My Vessel > Transducer Type**.
- 2 Select the type of transducer you are using.

Adjusting the Backlight

- 1 Select **Settings > System > Display > Backlight**.

TIP: Press > **Backlight** from any screen to open the backlight settings.

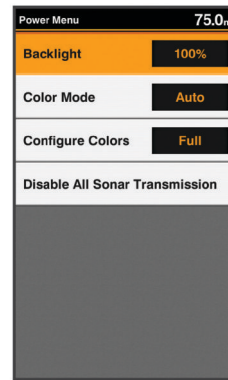

- 2 Adjust the backlight.

Changing the Color Mode

- 1 Select **Settings > System > Display > Color Mode**.

TIP: Press > **Color Mode** from any screen to access the color settings.

- 2 Select an option:

- To use a light background, select **Day Colors**.
- To use a dark background, select **Night Colors**.

TIP: You can configure the night color mode. Select **Configure Colors**, and select an option.

Setting the Beeper

You can set when the device makes sounds.

- 1 Select **Settings > System > Beeper**.

- 2 Select an option:

- To have the device beep when you select an item and when an alarm is triggered, select **On (Selections and Alarms)**.
- To have the device beep only when alarms are triggered, select **Alarms Only**.

Panning on the FF 350 Plus

You can move the sonar view to view an area other than your present location.

- 1 Select or to start panning.

2 Use the arrow keys to pan.

TIP: You can select BACK to stop panning.

Home Screen

The home screen provides access to all of the features in the device. The features are dependent on the accessories you have connected to the device.

When viewing another screen, you can return to the home screen by holding BACK. You can customize the layout of the screens and the items shown on the home screen.

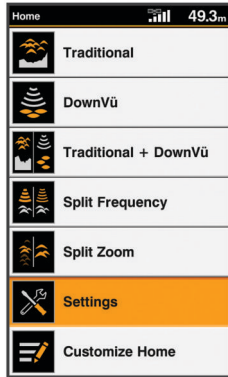

Customizing the Home Screen

You can add items to and rearrange items on the Home screen.

1 From the Home screen, select **Customize Home**.

2 Select an option:

- To rearrange an item, select **Rearrange**, select the item to move, and select the new location.
- To add an item to the Home screen, select **Add**, and select the new item.
- To remove an item you have added to the Home screen, select **Remove**, and select the item.

Adding the Data Graphs or Temperature Data Graphs Screen

You can view graphical sonar data on the home screen using the Depth Data Graph screen. You can view temperature data on the home screen using the Temperature Data Graph screen.

1 From the home screen, select **Customize Home > Add**.

2 Select **Depth Data Graph** or **Temperature Data Graph**.

Pages Shortcuts

You can quickly open commonly used pages by selecting PAGE from any page.



	Traditional
	ClearVü
	Split Frequency
	Shift Zoom
	ClearVü Shift Zoom

Default Shortcuts

	Depth Data Graph
	Temperature Data Graph

Available Shortcuts

Sonar

Traditional Sonar

You can see a full-view graph of sonar readings from a transducer on the full screen.

Select Traditional.

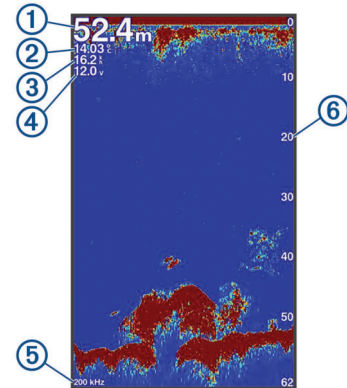

①	Bottom depth
②	Water temperature
③	GPS speed
④	Device voltage
⑤	Transducer frequency
⑥	Depth indicator as the sonar data the screen scrolls from right to left

Garmin ClearVü Sonar View

NOTE: To receive Garmin ClearVü scanning sonar, you need a compatible transducer.

Garmin ClearVü high-frequency sonar provides a detailed picture of the fishing environment around the boat in a detailed representation of structures the boat is passing over.

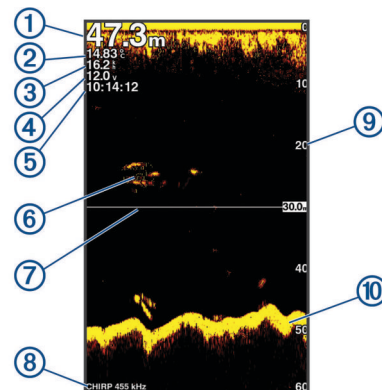

①	Bottom depth
②	Water temperature
③	GPS speed
④	Device voltage
⑤	Time
⑥	Suspended targets (fish)
⑦	Depth line
⑧	Transducer type and frequency, and zoom type
⑨	Depth indicator as the sonar data screen scrolls from right to left
⑩	Bottom echo

Traditional transducers emit a conical beam. The Garmin ClearVü scanning sonar technology emits two narrow beams, similar to the shape of the beam in a copying machine. These beams provide a clearer, picture-like image of what is around the boat.

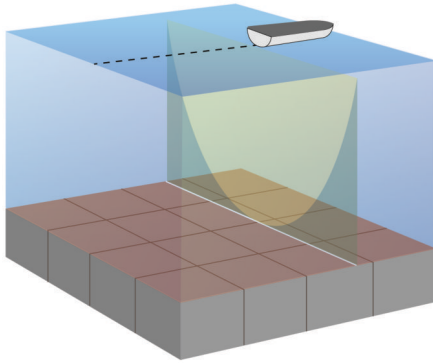

Split-Screen Frequency

You can view two frequencies from the split frequency screen.

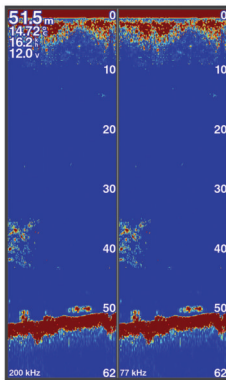

Shift-Zoom View

On the sonar screen, you can see a full-view graph of sonar readings on the right side of the screen, and a magnified portion of that graph on the left side of the screen.

Shift allows you to set the depth range on which the sonar is focused. This allows you to zoom in a higher resolution in the focused depth.

When using shift, bottom tracking may not work effectively, because the sonar looks for data within the depth range of the focused area, which may not include the bottom. Using shift also can impact the scroll speed, because data outside the depth range of the focused area is not processed, which reduces the time required to receive and display the data. You can zoom in

to the focused area, which enables you to evaluate target returns more closely at a higher resolution than just zooming alone.

The shift-zoom view is not available on all sonar screens.

From a sonar screen, select **ZOOM > Shift Zoom**.

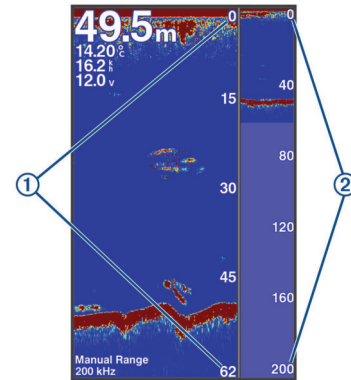

①	Zoomed depth scale
②	Depth range

Pausing the Sonar

From the **Traditional** sonar screen, select ◀ or ▶.

Adjusting the Zoom

You can adjust the zoom manually by specifying the span and a fixed starting depth. For example, when the depth is 15 m and the starting depth is 5 m, the device displays a magnified area from 5 to 20 m deep.

You also can allow the device to adjust the zoom automatically by specifying a span. The device calculates the zoom area from the bottom of the water. For example, if you select a span of 10 m, the device displays a magnified area from the bottom of the water to 10 m above the bottom.

1 From a sonar screen, select **ZOOM**.

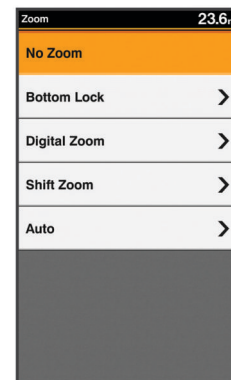

2 Select an option:

- Select **Bottom Lock** to lock the screen to the water bottom.
- Select **Manual** or **Digital Zoom** to manually set the zoom.
- Select **Auto** to automatically set the zoom.
- Select **Shift Zoom** to manually adjust the zoom.

Locking the Screen to the Water Bottom

You can lock the screen to the water bottom. For example, if you select a span of 20 meters, the device shows an area from the water bottom to 20 meters above the bottom. The span appears on the right side.

1 From a sonar view, select **MENU > ZOOM > Bottom Lock**.

2 Select a span.

Reducing the Clutter

You can quickly change the settings to reduce noise and clutter on the sonar screen.

- 1 From a sonar view, hold **CLUTTER**.
- 2 Select one or more options:
 - To adjust the sensitivity to reduce the effects of interference from nearby sources of noise, select **Interference**.
 - To hide sonar returns near the surface of the water, select **Surface Noise**.
 - To adjust the time varying gain, which can reduce noise, select **TVG**.

Sonar Frequencies

NOTE: The frequencies that are available depend on the transducer being used.

Adjusting the frequency helps adapt the sonar for your particular goals and the present depth of the water.

Selecting Frequencies

NOTE: You cannot adjust the frequency for all sonar views and transducers.

You can indicate which frequencies appear on the sonar screen.

- 1 From a sonar view, select **MENU > Frequency**.

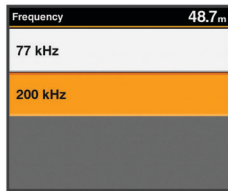

- 2 Select a frequency suited to your needs and water depth. For more information on frequencies, see [Sonar Frequencies, page 4](#).

Sonar Gain

The gain setting controls the sensitivity of the sonar receiver to compensate for water depth and water clarity. Increasing the gain shows more detail, and decreasing the gain reduces screen clutter.

NOTE: Setting the gain on one sonar view applies the setting to all the views.

Setting the Gain Automatically

NOTE: To set the gain on the split-frequency screen, you must set each frequency separately.

- 1 From a sonar view, select **GAIN**.

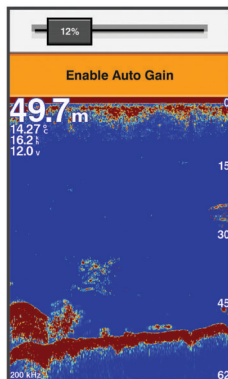

- 2 Select **▼ > Enable Auto Gain**.
- 3 Select an option:

- To display higher-sensitivity, weaker sonar returns with more noise automatically, select **Auto High**.
- To display medium-sensitivity sonar returns with moderate noise automatically, select **Auto Med**.
- To display lower-sensitivity sonar returns with less noise automatically, select **Auto Low**.

Setting the Gain Manually

- 1 From a sonar screen, select **GAIN**.

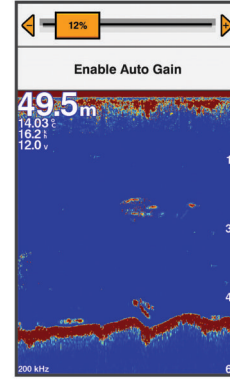

- 2 Select **+** or **▶** until you begin to see noise in the water portion of the screen.
- 3 Select **-** or **◀** to decrease the gain.

Adjusting the Range of the Depth Scale

You can adjust the range of the depth scale that appears on the right side of the screen. Automatic ranging keeps the bottom within the lower third of the sonar screen, and can be useful for tracking the bottom where there are slow or moderate terrain changes.

When the depth changes dramatically, like a drop off or cliff, manually adjusting the range allows a view of a specified depth range. The bottom is shown on the screen as long as the bottom is anywhere within the manual range established.

- 1 From a sonar screen, select **RANGE**.

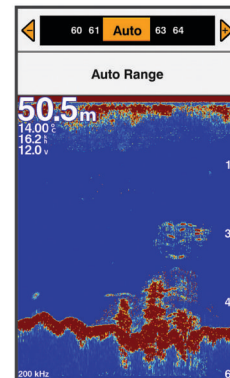

- 2 Select an option:
 - To allow the device to adjust the range automatically based on the depth, select **Auto Range**.
 - To increase or decrease the range manually, select **+** or **-**.

NOTE: From a sonar screen, select **+** and **-** to quickly manually adjust the range.

Showing and Customizing the Overlay Numbers

You can customize the data shown on the screen.

- 1 From an applicable screen, select **MENU**.

2 Select **Sonar Setup > Overlay Numbers > Show**.

Sonar Setup

NOTE: Not all options and settings apply to all models, sounder modules, and transducers.

Showing and Adjusting the Depth Line

You can show and adjust a horizontal line on a sonar screen. The depth of the line is indicated on the right side of the screen.

NOTE: Showing a depth line on one screen displays the depth line on all the screens.

- 1 From a sonar screen, select **MENU > Sonar Setup > Depth Line**.
- 2 Select **MENU**.
- 3 To adjust the **Depth Line**, select ▲ or ▼.

Setting the Scroll Speed

You can set the rate at which the sonar image moves across the screen. A higher scroll speed shows more detail, especially while moving or trolling. A lower scroll speed displays sonar information on the screen longer. Setting the scroll speed on one sonar view applies to all the sonar views.

- 1 From a sonar view, select **MENU > Sonar Setup > Scroll Speed**.

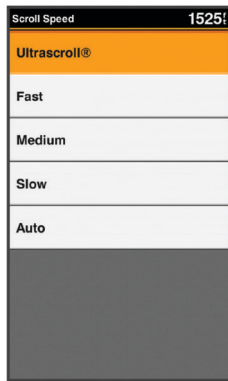

- 2 Select an option:
 - To adjust the scroll speed automatically using speed-over-ground, select **Auto**.
The Auto setting selects a scroll rate to match the boat speed, so targets in the water are drawn with the correct aspect ratio and appear less distorted.
 - To use a very fast scroll speed, select **Ultrascroll®**.
The Ultrascroll option quickly scrolls new sonar data, but with a reduced image quality. For most situations, the Fast option provides a good balance between a quickly scrolling image and targets that are less distorted.

Sonar Appearance Settings

From a sonar view, select **MENU > Sonar Setup > Appearance**.

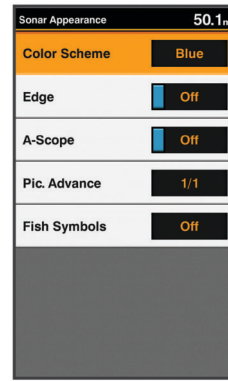

WARNING

Information is for reference only. Disabling warnings for underwater hazards can result in death, personal injury, or property damage. You are responsible for the safe and prudent operation of your vessel.

Color Scheme: Sets the color scheme.

Edge: Highlights the strongest signal from the bottom to help define the hardness or softness of the signal.

A-Scope: Displays a vertical flasher along the right side of the screen that shows instantaneously the range to targets along a scale.

Pic. Advance: Allows the sonar picture to advance faster by drawing more than one column of data on the screen for each column of sounder data received. This is especially helpful when you are using the sounder in deep water, because the sonar signal takes longer to travel to the water bottom and back to the transducer.

The 1/1 setting draws one column of information on the screen per sounder return. The 2/1 setting draws two columns of information on the screen per sounder return, and so on for the 4/1 and 8/1 settings.

Fish Symbols: Sets how the sonar interprets suspended targets.

Turning On the A-Scope

NOTE: This feature is not available in all sonar views.

The a-scope is a vertical flasher along the right side of the full-screen sonar view. This feature expands the most recently received sonar data so that it is easier to see. It can also be helpful for detecting fish that are close to the bottom.

From a sonar view, select **MENU > Sonar Setup > Appearance > A-Scope**.

Configuring the Appearance of Suspended Targets

NOTE: Configuring the appearance of suspended targets on one screen applies that setting to all screens.

NOTE: This feature is not available on all sonar views.

	Shows suspended targets as symbols.
	Shows suspended targets as symbols with target depth information.
	Shows suspended targets as symbols with background sonar information.
	Shows suspended targets as symbols with background sonar information and target depth information.

- 1 From a sonar screen, select **MENU > Sonar Setup > Appearance > Fish Symbols**.
- 2 Select an option.

Overlay Numbers

You can customize the data shown on the sonar screen.

From a sonar screen, select **MENU > Sonar Setup > Overlay Numbers**.

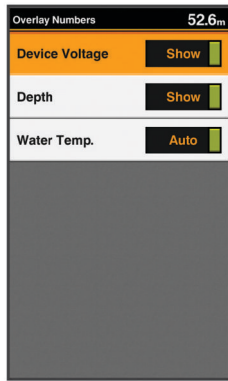

Device Voltage: Shows the voltage of the device.

Depth: Shows the transducer's present depth.

Water Temp.: Shows the present water temperature.

Device Configuration

FF 350 Plus Settings Menu Tree

- System
 - Display
 - Backlight
 - Color Mode
 - Configure Colors
 - Beeper
 - Off
 - Alarms Only
 - On (Selections and Alarms)
 - Auto Power
 - Language
 - System Information
 - Event Log
 - Software Information
 - Factory Settings
 - Simulator
- My Vessel
 - Keel Offset
 - Temp. Offset
 - Calibrate Water Speed
- Alarms
 - System
 - Device Voltage
 - Sonar
 - Shallow Water
 - Deep Water
 - Water Temp.
 - Fish
 - Off
 -
 -
 -
- Units
 - System Units

System Settings

Select **Settings > System**.

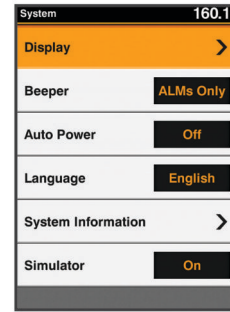

Display: Adjusts the backlight brightness (*Adjusting the Backlight, page 1*) and color scheme (*Changing the Color Mode, page 1*).

Beeper: Turns on and off the tone that sounds for alarms and selections (*Setting the Beeper, page 1*).

Auto Power: Turns on the device automatically when power is applied.

Language: Sets the on-screen language.

System Information: Provides information about the device and the software version.

Simulator: Turns on the simulator.

System Information

Select **Settings > Settings > System Information**.

Event Log: Allows you to view a log of system events.

Software Information: Provides information about the device and the software version.

Garmin Devices: Provides information about connected Garmin devices.

Factory Settings: Restores the device to factory settings.

NOTE: This deletes any setting information you have entered.

My Vessel Settings

NOTE: Some settings and options require additional hardware.

Select **Settings > My Vessel**.

Keel Offset: Offsets the surface reading for the depth of a keel, making it possible to measure depth from the bottom of the keel instead of from the transducer location (*Setting the Keel Offset, page 6*).

Temp. Offset: Compensates for the water temperature reading from a temperature-capable transducer (*Setting the Water Temperature Offset, page 7*).

Calibrate Water Speed: Calibrates the speed-sensing transducer or sensor (*Calibrating a Water Speed Device, page 7*).

Transducer Type: Displays the type of transducer connected to the device (*Selecting the Transducer Type, page 1*).

Setting the Keel Offset

You can enter a keel offset to compensate the surface reading for the depth of a keel, making it possible to measure water depth or depth below the keel instead of depth below the transducer. Enter a positive number to offset for a keel. You can enter a negative number to compensate for a large vessel that may draw several feet of water.

NOTE: A buffer of 2 to 3 feet from the bottom of the keel is recommended to ensure a safe distance from the keel to the bottom.

- Complete an action, based on the location of the transducer:
 - If the transducer is installed at the water line ①, measure the distance from the transducer location to the keel of the boat. Enter this value in steps 3 and 4 as a positive number to display depth below keel.
 - If the transducer is installed at the bottom of the keel ②, measure the distance from the transducer to the water line. Enter this value in steps 3 and 4 as a negative number to display water depth. Enter a 0 in this value to display depth below keel and depth below transducer.

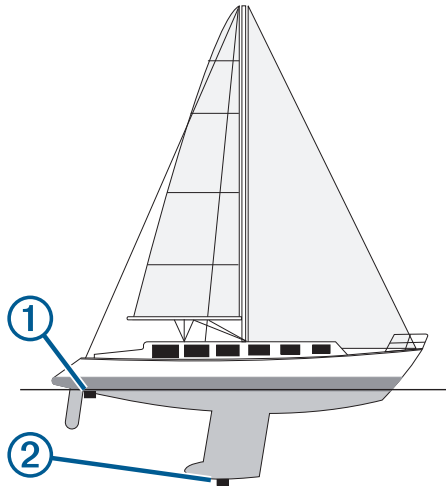

- Select **Settings > My Vessel > Keel Offset**.
- Select **+** or **-** based on the location of the transducer.
- Enter the distance measured in step 1.

Setting the Water Temperature Offset

You can set the temperature offset to compensate for the temperature reading from a temperature-capable sensor.

- Measure the water temperature using the temperature-capable transducer that is connected to the device.
- Measure the water temperature using a different thermometer or temperature sensor that is known to be accurate.
- Subtract the water temperature measured in step 1 from the water temperature measured in step 2.
This is the temperature offset. Enter this value in step 5 as a positive number if the sensor connected to the device measures the water temperature as being colder than it actually is. Enter this value in step 5 as a negative number if the sensor connected to the device measures the water temperature as being warmer than it actually is.
- Select **Settings > My Vessel > Temp. Offset**.
- Use the arrow keys to enter water temperature offset measured in step 3.

Calibrating a Water Speed Device

If you have a speed-sensing transducer connected to the chartplotter, you can calibrate that speed-sensing device to improve the accuracy of water-speed data displayed by the chartplotter.

- Select **Settings > My Vessel > Calibrate Water Speed**.
- Follow the on-screen instructions.
If the boat is not moving fast enough or the speed sensor is not registering a speed, a message appears.
- Select **OK**, and safely increase the boat speed.
- If the message appears again, stop the boat, and ensure the speed-sensor wheel is not stuck.
- If the wheel turns freely, check the cable connections.

- If you continue to get the message, contact Garmin product support.

Alarms Settings

System Alarm

Select **Settings > Alarms > System**.



Device Voltage: Sets an alarm to sound when the battery reaches a specified low voltage.

Sonar Alarms

Select **Settings > Alarms > Sonar**.

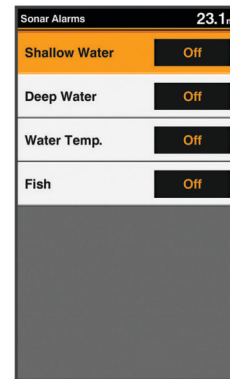

Shallow Water: Sounds when the water depth is shallower than the specified depth.

Deep Water: Sounds when the water depth is deeper than the specified depth.

Water Temp.: Sounds when the water temperature varies more than $\pm 2^{\circ}\text{F}$ ($\pm 1.1^{\circ}\text{C}$). Alarm settings are saved when the device is turned off.

NOTE: You must connect the device to a temperature-capable transducer to use this alarm.

Fish: Sets an alarm to sound when the device detects a suspended target.

- sets the alarm to sound when fish of all sizes are detected.
- sets the alarm to sound only when medium or large fish are detected.
- sets the alarm to sound only when large fish are detected.

Restoring the Factory Default Settings

NOTE: This deletes all settings information you have entered.

- Select **MENU > System > System Information > Factory Settings**.
- Select an option.

Appendix

Registering Your Device

Help us better support you by completing our online registration today.

- Go to my.garmin.com.

- Keep the original sales receipt, or a photocopy, in a safe place.

FF 350 Plus Specifications

Item	Measurement
Dimensions (W x H x D)	176 x 190 x 81.8 mm (6.94 x 7.5 x 3.25 in.)
Weight	696 g (1.5 lbs)
Screen size	6 inch
Resolution (W x H)	480 x 800 pixels
Temperature range	From -15° to 55°C (from 5° to 131°F)
Input power	From 10 to 36 Vdc
Typical current draw	0.7 A
Max power usage	15W @ 12 Vdc
Fuse	6 A
Water rating*	IEC 60529 IPX7
Frequencies	Traditional: 50/77/200 kHz Garmin ClearVü™: 260/455/800 kHz
Transmit power (RMS)**	300 W
Maximum depth***	1750 ft. freshwater, 830 ft. seawater
Compass-safe distance	30 cm (11.8 in.)

*The device withstands incidental exposure to water of up to 1 m for up to 30 min. For more information, go to www.garmin.com/waterrating.

**Dependent upon transducer rating and depth.

***Dependent upon the transducer, water salinity, bottom type, and other water conditions.

Troubleshooting

My device does not turn on

- Push the power cable all the way into the back of the device. Even if the cable seems to be connected, you should push firmly so that it is fully seated.
- Make sure the power source is generating power. You can check this several ways. For example, you can check whether other devices powered by the source are functioning.
- Check the fuse in the power cable. The fuse should be located in a holder that is part of the red wire of the power cable. Check that the proper size fuse is installed. Refer to the label on the cable or the installation instructions for the exact fuse size needed. Check the fuse to make sure there is still a connection inside of the fuse. You can test the fuse using a multimeter. If the fuse is good, the multimeter reads 0 ohm.
- Check to make sure the device is receiving at least 10 Vdc, but 12 Vdc is recommended. To check the voltage, measure the female power and ground sockets of the power cable for DC voltage. If the voltage is less than 10 Vdc, the device will not turn on.

My sonar does not work

- Push the transducer cable all the way into the back of the device. Even if the cable seems to be connected, you should push firmly so that it is fully seated.
- Check to make sure the sonar transmission is turned on.

物質宣言

部件名称	有毒有害物质或元素					
	铅	汞	镉	六价铬	多溴联苯	多溴二苯醚
印刷电路板组件	X	○	○	○	○	○

屏幕/背光	X	X	○	○	○	○
金属零件	X	○	○	○	○	○
电缆 电缆组件 连接器	X	○	○	○	○	○

本表格依据 SJ/T11364 的规定编制。

○: 代表此种部件的所有均质材料中所含的该种有害物质均低于 (GB/T26572) 规定的限量

X: 代表此种部件所用的均质材料中, 至少有一类材料其所含的有害物质高于

(GB/T26572) 规定的限量

*該產品說明書應提供在環保使用期限和特殊標記的部分詳細講解產品的擔保使用條件。



Index

A

alarms **7**
sonar **7**

B

backlight **1**
beeper **1**

C

clutter **4**
color mode **1**
compass **4**

D

data fields **5**
device
keys **1**
registration **7**
display settings **1, 6**

E

event log **6**

F

factory settings **6, 7**

G

Garmin ClearVü **2**

H

home screen **2**
customizing **2**

K

keel offset **6**
keys **1**
power **1**

L

language **6**

M

menu **6**

N

noise rejection **4**

O

overlay numbers **4, 5**

P

pages **2**. See sonar
panning **1**
product registration **7**
product support **1**

R

registering the device **7**

S

screen, brightness **1**
scroll speed **5**
settings **1, 6**
system information **6**
sonar **2, 3**
a-scope **5**
alarms **7**
appearance **2, 5**
bottom lock **3**
color scheme **5**
depth line **5**
depth scale **2, 4**
frequencies **3, 4**
gain **4**
Garmin ClearVü **2**
log **2**
noise **4**
suspended targets **2, 5**
views **2, 3**
zoom **3**

T

transducer **1, 2**
troubleshooting **8**

V

voltage **7**

W

water
speed **7**
temperature offset **7**

Z

zoom, sonar **3**

support.garmin.com

EAC CE

February 2017
190-02144-00_0B