

echo™ 200, 300c, 500c and 550c owner's manual



GARMIN®

© 2011 Garmin Ltd. or its subsidiaries

All rights reserved. Except as expressly provided herein, no part of this manual may be reproduced, copied, transmitted, disseminated, downloaded or stored in any storage medium, for any purpose without the express prior written consent of Garmin. Garmin hereby grants permission to download a single copy of this manual onto a hard drive or other electronic storage medium to be viewed and to print one copy of this manual or of any revision hereto, provided that such electronic or printed copy of this manual must contain the complete text of this copyright notice and provided further that any unauthorized commercial distribution of this manual or any revision hereto is strictly prohibited.

Information in this document is subject to change without notice. Garmin reserves the right to change or improve its products and to make changes in the content without obligation to notify any person or organization of such changes or improvements. Visit the Garmin Web site (www.garmin.com) for current updates and supplemental information concerning the use and operation of this and other Garmin products.

Garmin® and the Garmin logo are trademarks of Garmin Ltd. or its subsidiaries, registered in the USA and other countries. echo™ is a trademark of Garmin Ltd. or its subsidiaries. These trademarks may not be used without the express permission of Garmin.

Introduction

WARNING

See the *Important Safety and Product Information* guide in the product box for product warnings and other important information.

This manual includes information for the echo™ 200, the echo 300c, the echo 500c, and the echo 550c fishfinders.

Registering Your Device

Help us better support you by completing our online registration today.

- Go to <http://my.garmin.com>.
- Keep the original sales receipt, or a photocopy, in a safe place.

Contacting Garmin Product Support





Contact Garmin Product Support if you have any questions about this product.

- In the USA, go to www.garmin.com/support, or contact Garmin USA by phone at (913) 397.8200 or (800) 800.1020.
- In the UK, contact Garmin (Europe) Ltd. by phone at 0808 2380000.
- In Europe, go to www.garmin.com/support and click **Contact Support** for in-country support.

Manual Conventions

In this manual, the term “select” is used to describe these actions:

- Highlighting an item in a menu and pressing **ENTER**.
- Pressing a key, such as **ENTER** or **MENU**.

When you are instructed to select menu items, small arrows (>) may appear in the text. They indicate that you should highlight a series of items using  or  keys (page 1), and press the **ENTER** key after each item. For example, if you see “select **MENU** > **Pause/Rewind Sonar**,” you should press **MENU**, press  or  until **Pause/Rewind Sonar** is highlighted, and then press **ENTER**.

Entering Numerical Values

You can enter numerical values when setting alarms or setting an offset.



1. Select the value of the first digit using  and .
2. Select an option:
 - For the echo 200, echo 500c, and echo 550c, select  to advance to the next digit.
 - For the echo 300c, select **ENTER** to advance to the next digit.
3. Repeat steps 1 and 2 to adjust the value of all digits.

Table of Contents

Introduction	i	Flasher Page	8
Registering Your Device	i	Opening the Numbers Page	8
Contacting Garmin Product Support.....	i	Using the echo	9
Manual Conventions.....	i	Sonar Screen Settings.....	9
Entering Numerical Values	i	Alarms	13
Getting Started	1	Sonar Numbers	15
Keys.....	1	Calibration	16
Turning On and Turning Off the Device	1	Appendix	18
Color or Grayscale Display	1	Specifications	18
Configuring the Initial Device Settings.....	1	Cleaning the Outer Casing	18
Turning On the Device Automatically	1	Cleaning the Screen	18
Adjusting the Backlight	1	System Settings.....	18
Adjusting the Color Scheme	2	Software License Agreement.....	19
Setting the Color Mode.....	2	Index	20
Adjusting the Contrast of the echo 200	2		
Setting the Beeper	2		
Menu Timeout.....	3		
Using Quick Adjust	3		
Viewing Pages	4		
Selecting a Page	4		
Full Screen Page.....	4		
Split Zoom Page.....	5		
Split Frequency Page	5		
Log Pages	6		

Getting Started





Keys



echo 300c



echo 200, echo 500c,
and echo 550c

MENU	Displays or hides a list of options.
ENTER	Selects a menu item.
 	Scrolls through options or changes settings.
 	Selects page options (page 4) on the echo 200, echo 500c, and echo 550c.
	Turns the device on or off and adjusts the backlight.

Turning On and Turning Off the Device

Press .

Color or Grayscale Display

The echo 200 has a grayscale display. The echo 300c, echo 500c, and echo 550c have color displays.

Configuring the Initial Device Settings

When you turn on the device the first time, you must configure a series of initial settings.

You must also configure these settings after restoring original factory settings ([page 19](#)). You can update each of these settings later.

1. Turn on the device.
The device prompts you to enter the initial device settings.
2. Follow the on-screen instructions.



Turning On the Device Automatically

You can set the device to turn on when power is applied.

From any page, select **MENU > Setup > System > Auto Power > On**.

Adjusting the Backlight

1. From any page, select **MENU > Setup > System > Backlight**.
2. Select  and  to adjust the brightness of the backlight.

TIP: Press  to open the backlight adjustment bar. Press  repeatedly to cycle through the brightness settings.

Adjusting the Color Scheme

Before you can adjust the color scheme, you must open the Full Screen page (page 4), the Split Zoom page (page 5), the Split Frequency page (page 5), or the Flasher page (page 8).

For the echo 300c, the echo 500c, and the echo 550c, you can select the color scheme displayed on a sonar screen.

Color Scheme	Color	Description
White	Yellow	Strong return
	Purple	Medium return
	Blue	Weak return
	White (Black in night mode)	No return
Blue	Red	Strong return
	Yellow	Medium return
	Light Blue	Weak return
	Blue	No return
echo 200	Darker shades	Stronger return
	Lighter shades	Weaker return
	White	No return





1. From any page, select **MENU > Setup > Sonar Setup > Color Scheme**.
2. Select a color scheme.

Setting the Color Mode

For the echo 300c, the echo 500c, and the echo 550c, you can select the color mode (for day or night use) of the sonar screen.

1. From any page, select **MENU > Setup > System > Color Mode**.
2. Select **Day** or **Night**.

Adjusting the Contrast of the echo 200

1. From any page, select **MENU > Setup > System > Contrast**.
2. Select  or  to adjust the contrast.
TIP: Hold  or  to make large adjustments quickly.
3. Select **ENTER**.

Setting the Beeper

You can set when the device makes audible sounds.

1. From any page, select **MENU > Setup > System > Beeper**.
2. Select an option:
 - To have the device beep when you select an item and when an alarm is triggered, select **On**.
 - To have the device beep only when alarms are triggered, select **Alarms Only**.



Menu Timeout

If a menu is open for 15 seconds and no keys are selected, the menu closes and your previous screen is displayed.

Using Quick Adjust

Before you can use quick adjust, you must open the Full Screen page (page 4), the Split Zoom page (page 5), the Split Frequency page (page 5), or the Flasher page (page 8).

After adjusting a setting and returning to a page, you can quickly return to the setting options.

After returning to the page, select  or .





Viewing Pages

Pages allow you to view sonar information in different formats.

- Three sonar pages
 - Full Screen page (page 4)
 - Split Zoom page (page 5)
 - Split Frequency page (page 5)
- Log page for temperature or depth (page 6)
- Flasher page (page 8)
- Numbers page (page 8)

Selecting a Page

1. From any page, select **MENU** > **Pages**.
2. Select a page.

TIP: When using the echo 200, the echo 500c, or the echo 550c, select  or  from any page to quickly access the page menu. Select  or  to select a page.

Full Screen Page

The Full Screen page shows a full-view graph of sonar readings from a transducer.

From any page, select **MENU** > **Pages** > **Full Screen**.

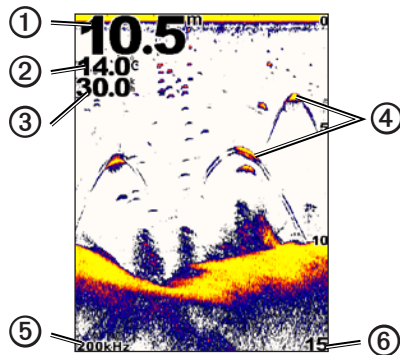

①	Bottom depth at your present location.
②	Water temperature.
③	Water speed (if a water-speed capable transducer is connected).
④	Suspended targets.
⑤	Transducer frequency.
⑥	Screen depth as screen scrolls from right to left.

Split Zoom Page

The Split Zoom page shows a full-view graph of sonar readings on the right side of the screen, and a magnified portion of that graph on the left side of the screen.

From any page, select **MENU > Pages > Split Zoom**.

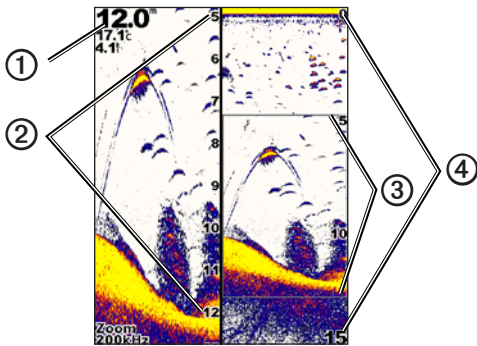

①	Depth, water temperature, and water speed.
②	Zoomed depth scale.
③	Zoom window.
④	Depth range.

Increasing the Width of the Zoom Screen

You can increase the width of the magnified portion of the Split Zoom page.

From the Split Zoom page, select **MENU > Setup > Sonar Setup > Split Size > Large**.

Split Frequency Page

On the Split Frequency page, the left side of the screen shows 77 kHz frequency sonar data, and the right side of the screen shows 200 kHz frequency sonar data.

NOTE: The Split Frequency page requires the use of a dual-beam transducer.

From any page, select **MENU > Pages > Split Frequency**.

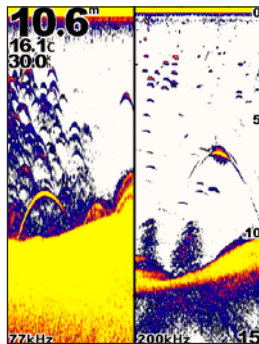

Log Pages

You can view a log of depth readings (page 6) or water temperature readings (page 7) on the full screen. You can also view both logs simultaneously on a split screen log (page 7). The graph scrolls to the left as information is received.

When you open a log page, the last log page you selected is shown (depth, water temperature, or both). You can then select a different log page.

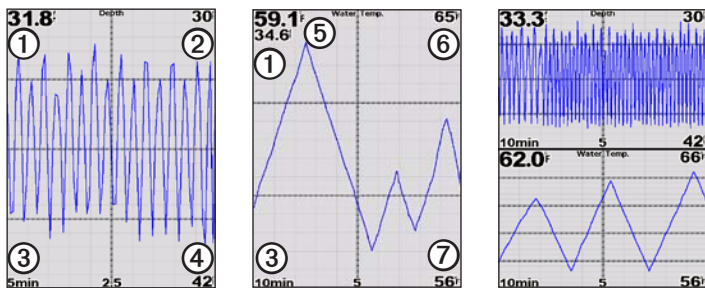

Depth Log

Temperature Log

Split Screen Log

①	Depth at your present location.
②	Depth value at top of log.
③	Log duration.
④	Depth value at bottom of log.
⑤	Water temperature at your present location.
⑥	Temperature value at top of log.
⑦	Temperature value at bottom of log.

Opening the Depth Log Page

The Depth Log page displays a graphic log of depth readings over time.

1. From any page, select **MENU > Pages > Log**.
2. If the temperature log or the split screen log is shown, select **MENU > Change Log > Depth**.

Setting the Depth Log Duration

Before you can set the depth log duration, you must open the depth log or the split screen log.

You can change the time scale (duration) on the depth log. Increasing the duration allows you to view depth variations over a longer period of time. Decreasing the duration allows you to view more detail over a shorter period of time.

The duration appears in the lower-left corner of the screen.

Setting the Depth Log Scale

Before you can set the depth-range scale, you must open the depth log or the split screen log.

You can change the depth-range scale on the depth log. Increasing the depth-range scale allows you to view more variations in depth. Decreasing the depth-range scale allows you to view more detail in the variation. When the scale is set to **Auto**, the depth range automatically adjusts to display all the log values within the selected duration.

1. Select **MENU > Depth Log Options > Scale**.
2. Select a depth-range scale.

Viewing the Temperature Log Page

The Temperature Log page displays a graphic log of water temperature readings over time.

1. From any page, select **MENU > Pages > Log**.
2. If the temperature log or the split screen log is shown, select **MENU > Change Log > Temperature**.

Setting the Temperature Log Duration

Before you can set the temperature log duration, you must open the temperature log ([page 7](#)) or the split screen log ([page 7](#)).

You can change the time scale on the water temperature log. Increasing the time scale allows you to view temperature variations over a longer period of time. Decreasing the time scale allows you to view more detail over a shorter period of time.

1. Select **MENU > Temp. Log Options > Duration**.
2. Select a duration.

Setting the Temperature Log Scale

Before you can set the temperature-range scale, you must open the temperature log ([page 7](#)) or the split screen log ([page 7](#)).

You can change the temperature-range scale on the temperature log. Increasing the temperature-range scale allows you to view more variations in temperature. Decreasing the temperature-range scale allows you to view more detail in the variation. When the scale is set to **Auto**, the temperature range automatically adjusts to display all the log values within the selected duration.

1. Select **MENU > Temp. Log Options > Scale**.
2. Select a temperature-range scale.

Viewing the Depth Log and the Temperature Log Simultaneously.

You can view the depth log and temperature log simultaneously on the split screen log. You can adjust the depth log duration ([page 6](#)), the depth log scale ([page 6](#)), the temperature log duration ([page 7](#)), or the temperature log scale ([page 7](#)) from this screen.

1. From any page, select **MENU > Pages > Log**.
2. If the temperature log or the depth log is shown, select **MENU > Change Log > Both**.

Flasher Page

The Flasher page displays sonar information on a circular depth scale, indicating what is beneath your boat. It is organized as a ring that starts at the top and progresses clockwise. Depth is indicated by the scale inside the ring. Sonar information flashes on the ring when it is received at the depth indicated. The colors indicate different strengths of the sonar return (refer to the table on [page 2](#)).

From any page, select **MENU > Pages > Flasher**.

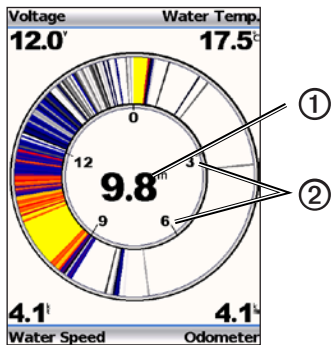

①	Depth at your present location.
②	Depth scale.

Opening the Numbers Page

The Numbers page displays numeric information instead of a graph.

From any page, select **MENU > Pages > Numbers**.

Resetting the Odometer to Zero

NOTE: The device must be connected to a speed-wheel transducer to use the odometer.

From the Numbers page, select **MENU > Reset Odometer**.

Using the echo



Sonar Screen Settings

The Full Screen page, the Split Zoom page, the Split Frequency page, and the Flasher page are a visual representation of the area beneath your boat. These sonar views can be customized as indicated in the following paragraphs.

Adjusting the Range of the Depth Scale

Before you can adjust the range of the depth scale, you must open the Full Screen page (page 4), the Split Zoom page (page 5), the Split Frequency page (page 5), or the Flasher page (page 8).

You can adjust the range of the depth scale that appears on the right side of the Full Screen page, the Split Zoom page, and the Split Frequency page, and the inside of the flasher. This setting determines how deep the sonar will search for targets.

1. Select **MENU > Range**.
2. Select an option:
 - To allow the device to adjust the range automatically based on the depth, select **Auto**.
 - To increase or decrease the range of the depth scale manually, select **Manual**, select  or , then select **ENTER**.

When you set the range on one page, that setting is applied to the other pages.

Zoom Adjustments

You can adjust the zoom of the Full Screen page, the Split Zoom page, and the Split Frequency page manually, or you can allow the device to adjust the zoom automatically.



Adjust the zoom manually by selecting the span (amount of sonar data that will be displayed in the zoomed window) and selecting a fixed starting depth. For example, if you select a span of 15 meters and a starting depth of 5 meters, the device will display an area from 5 meters deep to 20 meters deep.

When you adjust the zoom automatically, the span is the area that will be displayed on the screen from the contour of the bottom of the water. For example, if you select a span of 10 meters, the device will display an area from the bottom of the water to 10 meters above the bottom.

Adjusting the Zoom Manually

Before you can adjust the zoom manually, you must open the Full Screen page (page 4), the Split Zoom page (page 5), or the Split Frequency page (page 5).

When you set the span of the zoom on one page, the other pages are not affected.

1. Select **MENU > Zoom > Manual Zoom > Span**.
2. Select the span you would like to show.
3. Select **Depth**.
4. Select  or , to adjust the viewing window.
5. Select **ENTER > Done**.

Adjusting the Zoom Automatically

Before you can adjust the zoom automatically, you must open the Full Screen page (page 4), the Split Zoom page (page 5), or the Split Frequency page (page 5).

When you set the zoom to **Auto Zoom** on one page, that setting does not affect the other pages.

1. Select **MENU > Zoom > Auto Zoom**.
2. Select the span.

Locking the Screen to the Water Bottom

Before you can adjust the zoom, you must open the Full Screen page (page 4), the Split Zoom page (page 5), or the Split Frequency page (page 5).

You can lock the screen to the water bottom of the Full Screen page, the Split Zoom page, or the Split Frequency page by selecting the span and locking the screen to the bottom of the water. For example, if you select a span of 20 meters, the device will display an area from the water bottom to 20 meters above the bottom. The distance from the bottom is displayed on the right side of the screen.

When you set the zoom to bottom lock on one page, that setting does not affect the other pages.

1. Select **MENU > Zoom > Bottom Lock**.
2. Select a span.

Pausing the Sonar Screen

Before you can pause the screen, you must open the Full Screen page (page 4), the Split Zoom page (page 5), or the Split Frequency page (page 5).

1. Select **MENU**.
2. Select an option.
 - For the echo 200, echo 500c, or echo 550c, select **Pause/Rewind Sonar**.
 - For the echo 300c, select **Pause Sonar**.

Resuming the Sonar Screen

After pausing the screen or viewing the sonar history, select **MENU > Resume Sonar**.

Sonar History Rewind

When using the echo 200, the echo 500c, or the echo 550c, you can pause the screen and then scroll the screen to view your sonar history.

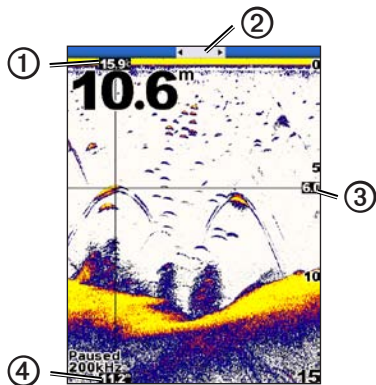

①	Water temperature at the location indicated by the vertical line.
②	Scroll bar gives an indication of how far back you have scrolled.
③	Depth of the horizontal line.
④	Depth at the location indicated by the vertical line.

Opening the Sonar History

Before you can view your sonar history, you must open the Full Screen page (page 4), the Split Zoom page (page 5), or the Split Frequency page (page 5) in the echo 200, echo 500c, or the echo 550c.

1. Select **MENU > Pause/Rewind Sonar**.
2. Select **◀** or **▶** to scroll the screen and move the vertical line.
3. Select **▲** or **▼** to adjust the horizontal depth line.

Setting the Sonar Scroll Speed

Before you can adjust the scroll speed of the depth scale, you must open the Full Screen page (page 4), the Split Zoom page (page 5), the Split Frequency page (page 5), or the Flasher page (page 8).

You can set the rate at which the sonar scrolls from right to left.

Use a higher scroll speed to see more detail, especially while moving or trolling. Use a lower scroll speed to display the sonar information on the screen longer.

When you set the scroll speed on one page, that setting is applied to the other pages.

1. Select **MENU > Setup > Sonar Setup > Scroll Speed**.
2. Select a scroll speed.

Showing and Adjusting the Depth Line

Before you can show the depth line, you must open the Full Screen page (page 4), the Split Zoom page (page 5), or the Split Frequency page (page 5).

You can show and adjust a horizontal line on a sonar screen. The depth of the line is indicated on the right side of the screen.

When you show a depth line on one page, the line is also displayed on the other pages.

1. Select **MENU > Depth Line > On**.

2. To adjust the depth line, select  or .

Selecting a Frequency

Before you can select a frequency, you must open the Full Screen page ([page 4](#)), the Split Zoom page ([page 5](#)), or the Flasher page ([page 8](#)).

When using a dual-beam transducer, you can select a frequency of 200 kHz or 77 kHz.

The 200 kHz frequency shows better detail, has a narrower beam, and is typically used in shallower waters.

The 77 kHz frequency has a wider beam, so it can be used to cover a larger area. It can be used as a search tool to locate structure, such as brush piles, and to see more fish.

When you select a frequency on one page, that setting is applied to the other pages.



1. Select **MENU > Setup > Sonar Setup > Frequency**.
2. Select a frequency.

Configuring the Appearance of Suspended Targets

Before you can set how the sonar interprets suspended targets, you must open the Full Screen page ([page 4](#)), the Split Zoom page ([page 5](#)), or the Split Frequency page ([page 5](#)).

When you configure the appearance of suspended targets on one page, that setting is applied to the other pages.

1. Select **MENU > Setup > Sonar Setup > Fish Symbols**.
2. Select an option:
 - To show suspended targets as symbols, select .

- To show suspended targets as symbols with target depth information, select .
- To show suspended targets as symbols with background sonar information, select .
- To show suspended targets as symbols with background sonar information and target depth information, Select .

A-Scope

The A-Scope is a vertical flasher along the right side of the Full Screen page that shows the range to targets in real time along a scale. This view expands the most recently received sonar data so that it is easier to see. It can also be helpful in detecting fish that are located close to the bottom.

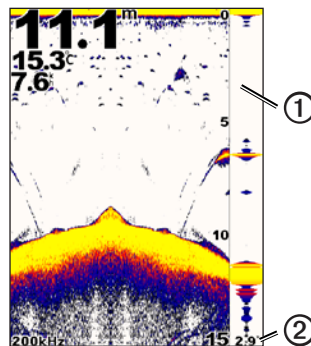

①	A-Scope
②	Diameter of the sonar cone at the present depth.

Turning On the A-Scope

From the Full Screen page (page 4), select **MENU > Setup > Sonar Setup > A-Scope > On**.

Alarms

Setting the Shallow Water and Deep Water Alarms

You can set an alarm to sound when the depth is shallower or deeper than a specified value.

NOTE: Alarm settings are saved when the device is turned off.

1. From any page, select **MENU > Setup > Alarms**.
2. Select an option:
 - To sound an alarm when the depth is shallower than the specified depth, select **Shallow Water > On**.
 - To sound an alarm when the depth is deeper than the specified depth, select **Deep Water > On**.
3. Enter the value (page i) of the alarm setting.
4. Select **ENTER** to accept the value.

The alarm setting appears.
5. Select **Done** or **Confirm**.

Setting the Battery Voltage Alarm

You can set an alarm to sound when the battery reaches a specified low voltage.

NOTE: Alarm settings are saved when the device is turned off.

1. From any page, select **MENU > Setup > Alarms > Battery > On**.







2. Enter the value of the alarm setting (page i).
3. Select **ENTER** to accept the value.

The alarm setting appears.
4. Select **Done** or **Confirm**.

Setting Fish Alarms

You can set an alarm to sound when the device detects a suspended target.

NOTE: Alarm settings are saved when the device is turned off.

1. From any page, select **MENU > Setup > Alarms > Fish**.
2. Select an option:
 - Select    to sound an alarm for all fish sizes.
 - Select   to sound an alarm for medium and large fish only.
 - Select  to sound an alarm for large fish only.

Setting the Water Temperature Alarm

If the device is connected to a temperature transducer, you can set an alarm to sound when the water temperature varies more than ± 2 °F (± 1.1 °C).

NOTE: Alarm settings are saved when the device is turned off.

1. From any page, select **MENU > Setup > Alarms > Water Temperature > On**.
2. Enter the value of the alarm setting (page i).
3. Select **ENTER** to accept the value.

The alarm setting appears.
4. Select **Done** or **Confirm**.

Setting the Drift Alarm

You can set an alarm to sound when variations in depth at your present location exceed the specified depth.

NOTE: Alarm settings are saved when the device is turned off.

1. From any page, select **MENU > Setup > Alarms > Drift > On**.
2. Enter the value of the alarm setting (page i).
3. Select **ENTER** to accept the value.

The alarm setting appears.

4. Select **Done** or **Confirm**.

Sonar Gain and Noise Settings

You can adjust the amount of gain and noise on a sonar screen.

When you set the gain on one page, that setting is applied to the other pages.



Setting the Gain Manually

Before you can adjust the gain, you must open the Full Screen page (page 4), the Split Zoom page (page 5), the Split Frequency page (page 5), or the Flasher page (page 8).

The gain setting controls the sensitivity of the sonar receiver to compensate for water depth and water clarity. To see more detail, increase the gain. If the screen is cluttered, decrease the gain.

To set the gain manually, increase the gain setting until you begin to see “noise” in the water portion of the screen, then slightly decrease the gain.

NOTE: To set the gain on the Split Frequency page, you must set the 77 kHz and the 200 kHz screens separately.

1. Select **MENU > Gain > Manual**.
2. Select  to increase the gain setting until you begin to see noise in the water portion of the screen.
3. Select  to decrease the gain.

Setting the Gain to Auto

Before you can adjust the gain, you must open the Full Screen page (page 4), the Split Zoom page (page 5), the Split Frequency page (page 5), or the Flasher page (page 8).

NOTE: To set the gain on the Split Frequency page, you must set the 77 kHz and the 200 kHz screens separately.

1. Select **MENU > Gain**.
2. Select an option:
 - To display the sonar screen with higher sensitivity and to show weaker signals and more noise, select **Auto-High**.
 - To display the sonar screen with normal sensitivity, select **Auto-Med**.
 - To display the sonar screen with lower sensitivity and less noise, select **Auto-Low**.

Setting Noise Rejection

Before you can set the noise rejection, you must open the Full Screen page (page 4), the Split Zoom page (page 5), or the Split Frequency page (page 5).

You can minimize the appearance of weak sonar returns by increasing noise rejection.

When you set noise rejection on one page, that setting is applied to the other pages.

NOTE: To set noise rejection on the Split Frequency page, you must set the 77 kHz and the 200 kHz screens separately.

1. Select **MENU > Setup > Sonar Setup > Noise Reject**.
2. Select the level of noise rejection.

Hiding Surface Noise

Before you can hide surface noise, you must open the Full Screen page (page 4), the Split Zoom page (page 5), or the Split Frequency page (page 5).

You can set whether the sonar returns near the surface of the water appear. Hide surface noise to help reduce clutter.

When you show or hide the surface noise on one page, that setting is applied to the other pages.

Select **MENU > Setup > Sonar Setup > Surface Noise > Hide**.

Sonar Numbers

You can adjust which numbers (water temperature, battery voltage, water speed, and water speed odometer) are displayed on the Full Screen page, the Split Zoom page, and the Split Frequency page. You can also adjust the size of those numbers.

NOTE: The device must be connected to a temperature transducer to show the water temperature. The device must be connected to a speed-wheel transducer to show the water speed.

Showing the Water Temperature

Before you can show the water temperature, you must open the Full Screen page (page 4), the Split Zoom page (page 5), or the Split Frequency page (page 5).

1. Select **MENU > Setup > Sonar Numbers > Water Temperature**.
2. Select **Auto**.

Showing the Water Speed

Before you can show the water speed, you must open the Full Screen page (page 4), the Split Zoom page (page 5), or the Split Frequency page (page 5).

1. Select **MENU > Setup > Sonar Numbers > Water Speed**.
2. Select **Auto**.

Showing the Battery Voltage

Before you can show the battery voltage, you must open the Full Screen page (page 4), the Split Zoom page (page 5), or the Split Frequency page (page 5).

1. Select **MENU > Setup > Sonar Numbers > Battery**.
2. Select **Show**.

Showing the Water Speed Odometer

Before you can show the odometer, you must open the Full Screen page (page 4), the Split Zoom page (page 5), or the Split Frequency page (page 5).

To reset the odometer to zero, see page (page 8).

1. Select **MENU > Setup > Sonar Numbers > Odometer**.
2. Select **Auto**.

Setting the Number Size

Before you can set the number size, you must open the Full Screen page (page 4), the Split Zoom page (page 5), or the Split Frequency page (page 5).

1. Select **MENU > Setup > Sonar Numbers > Number Size**.
2. Select a number size.

Calibration

Setting the Keel Offset

The keel offset compensates for the surface reading for the depth of a keel, making it possible to measure depth from the bottom of the keel instead of from the transducer location.

1. Select an option, based on the location of the transducer:
 - If the transducer is installed at the water line ①, measure the distance from the transducer location to the keel of the boat. Enter this value in steps 4 and 5 as a positive number.
 - If the transducer is installed at the bottom of the keel ②, measure the distance from the transducer to the water line. Enter this value in steps 4 and 5 as a negative number.

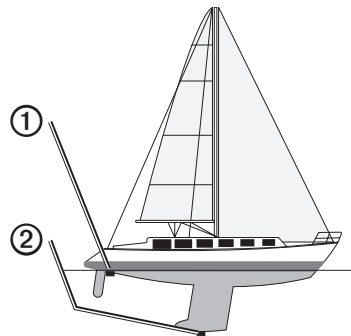

2. From any page, select **MENU > Setup > Calibration > Keel Offset**.
3. Use **▲** and **▼** to select positive (+) or negative (-), based on the location of the transducer.



4. Enter the value (page i) of the offset.
5. Select **ENTER**.
6. Check the keel offset value on the Calibration screen to ensure you have entered the correct value.

Setting the Water Temperature Offset

The temperature offset compensates for the temperature reading from a temperature-capable sensor.

1. Measure the water temperature using the temperature-capable transducer that is connected to the echo.
2. Measure the water temperature using a thermometer or a different temperature sensor that is known to be accurate.
3. Subtract the water temperature measured in step 1 from the water temperature measured in step 2.

This is the temperature offset. Enter this value in steps 5 and 7 as a positive number if the sensor connected to the echo measures the water temperature as being colder than it actually is. Enter this value in steps 5 and 7 as a negative number if the sensor connected to the echo measures the water temperature as being warmer than it actually is.

4. From any page, select **MENU > Setup > Calibration > Temperature Offset**.
5. Use  and  to select positive (+) or negative (-), based on the value measured in step 3.
6. Enter the value (page i) of the alarm setting.
7. Select **ENTER**.
8. Check the temperature offset value on the Calibration screen to ensure you have entered the correct value.

Calibrating the Water Speed Sensor

1. From any page, select **MENU > Setup > Calibration > Calibrate Water Speed**.
2. Follow the on-screen instructions.

NOTE: Be sure to enter the top speed as measured by an external source, such as a GPS. (Do not enter the Water Speed value displayed on the Calibrate Water Speed screen.)

Appendix

Specifications

Specification	Measurement
Temperature Range	echo 200: From 5°F to 158°F (from -15°C to 70°C) echo 300c/500c/550c: From 5°F to 131°F (from -15°C to 55°C)
Compass Safe Distance	echo 200: 9.9 in. (250 mm) echo 300c: 13.8 in. (350 mm) echo 500c/550c: 15.75 in. (400 mm)
Power Source Voltage Range	10–28 Vdc
Rated Current	1 A
Fuse	AGC/3AG - 3.0 A
Freshwater Depth*	echo 200/300c: 1500 ft. (457 m) echo 500c/550c: 1900 ft. (579 m)
Saltwater Depth*	echo 200/300c: 600 ft. (183 m) echo 500c/550c: 700 ft. (213 m)

*Depth capacity is dependent on water salinity, bottom type, and other water conditions.

The transducer provided with the echo 200/300c/500/550c has beam angles of 15 and 45 degrees at 3dB. However, when this transducer is used with the echo device, it can detect the smallest signals up to 60 and 120 degrees. Shallow and deep water performance is maximized because the echo series shows more fish when shallow, and reaches deep to show structure and bottom contours.

Cleaning the Outer Casing

NOTICE

Avoid chemical cleaners and solvents that can damage plastic components.

1. Clean the outer casing (not the screen) of the device using a cloth dampened with a mild detergent solution.
2. Wipe the device dry.

Cleaning the Screen

NOTICE

Cleaners containing ammonia will harm the anti-reflective coating.

The device is coated with a special anti-reflective coating which is very sensitive to skin oils, waxes, and abrasive cleaners.

1. Apply an eyeglass lens cleaner specified as safe for anti-reflective coatings to the cloth.
2. Gently wipe the screen with a soft, clean, lint-free cloth.

System Settings

Setting the Language

1. From any page, select **MENU > Setup > Units > Language**.
2. Select the language.

Setting the Units of Measure

You can set the units of measure the echo shows.

1. From any page, select **MENU > Setup > Units**.
2. Select an option:
 - Select **Depth**, and select **Feet (ft)**, **Meters (m)**, or **Fathoms (fa)**.
 - Select **Temperature**, and select **Fahrenheit (°F)** or **Celsius (°C)**.
 - Select **Water Speed**, and select **Miles/Hour (mh)**, **Kilometers/Hour (kh)**, or **Knots (kt)**.
 - Select **Distance**, and select **Statute (mi, ft)**, **Metric (km, m)**, **Nautical (nm, ft)**, or **Nautical (nm, m)**.

Viewing System Information

From any page, select **MENU > Setup > System > System Information**.

Restoring the Original Factory Settings

NOTE: This procedure deletes all settings information you have entered.

From any page, select **MENU > Setup > System > System Information > Factory Settings > Yes**.

Software License Agreement

BY USING THE ECHO 200, THE ECHO 300C, THE ECHO 500C, OR ECHO 550C, YOU AGREE TO BE BOUND BY THE TERMS AND CONDITIONS OF THE FOLLOWING SOFTWARE LICENSE AGREEMENT. PLEASE READ THIS AGREEMENT CAREFULLY.

Garmin Ltd. and its subsidiaries (“Garmin”) grant you a limited license to use the software embedded in this device (the “Software”) in binary executable form in the normal operation of the product. Title, ownership rights, and intellectual property rights in and to the Software remain in Garmin and/or its third-party providers.

You acknowledge that the Software is the property of Garmin and/or its third-party providers and is protected under the United States of America copyright laws and international copyright treaties. You further acknowledge that the structure, organization, and code of the Software, for which source code is not provided, are valuable trade secrets of Garmin and/or its third-party providers and that the Software in source code form remains a valuable trade secret of Garmin and/or its third-party providers. You agree not to decompile, disassemble, modify, reverse assemble, reverse engineer, or reduce to human readable form the Software or any part thereof or create any derivative works based on the Software. You agree not to export or re-export the Software to any country in violation of the export control laws of the United States of America or the export control laws of any other applicable country.

 - LAMPS INSIDE THE ECHO 500C AND THE ECHO 550C CONTAIN MERCURY AND MUST BE RECYCLED OR DISPOSED OF ACCORDING TO LOCAL, STATE, OR FEDERAL LAWS.

For more information go to:

www.garmin.com/aboutGarmin/environment/disposal.jsp.

Index

A

alarms

- battery voltage 13
- beeper 2
- drift 14
- fish 13
- shallow and deep water 13
- temperature 13

A-Scope 12

B

- backlight 1
- battery voltage
 - alarm 13
 - showing 16
- beeper 2
- bottom lock 10
- brightness 1
- buttons 1

C

- calibration
 - keel offset 16
 - temperature offset 17
 - water speed sensor 17

cleaning

- outer casing 18
- screen 18
- color mode 2
- color scheme 2
- compass safe distance 18
- contacting product support i
- contrast, screen 2

D

- day and night settings 2
- deep water alarm 13
- depth line 11
- depth log
 - duration 6
 - scale 6
 - viewing 6,7
- depth scale 9
- drift alarm 14

F

- factory settings, restoring 19
- fish
 - alarm 13
 - symbols 12
- Flasher page 8
- frequency
 - selecting 12
 - split screen 5
- Full Screen page 4

G

- gain
 - setting automatically 14
 - setting manually 14

I

- identification number 19

K

- keel offset 16
- keys 1

L

- language 18
- line, depth 11
- Log page 6
 - depth 6
 - temperature 7

M

- measurement units 19

N

- night and day settings 2
- noise rejection 15
- numbers
 - showing 15
 - size on screen 16
 - sonar 15
- Numbers page 8

O

- odometer
 - resetting 8
 - showing 16

P

- pages 4
- pause/rewind sonar 10,11
- product support, contacting i

R

- registering your device i

S

- screen
 - brightness 1
 - contrast 2
 - day or night 2
 - pausing 10
 - resuming after pausing 10
 - scroll speed 11
 - sensor, speed, calibrating 17
 - shallow water alarm 13
 - software version 19
 - sonar history 10,11
 - sonar numbers 15
 - span 9,10
 - speed sensor, calibrating 17
 - speed, showing 15
 - Split Frequency page 5
 - split size 5

Split Zoom page 5
surface noise 15
symbols, fish 12
system information 19

T

temperature alarm 13
temperature log
 duration 7
 scale 7
 viewing 7
temperature offset 17
temperature, showing 15

U

units of measure 19

V

version, software 19
voltage alarm 13

W

water speed
 odometer, displaying 16
 sensor, calibrating 17
 showing 15
water temperature alarm 13
water temperature offset 17
water temperature, showing 15

Z

zoom
 adjusting automatically 10
 adjusting manually 9
 split screen 5



© 2011 Garmin Ltd. or its subsidiaries

Garmin International, Inc.
1200 East 151st Street, Olathe, Kansas 66062, USA

Garmin (Europe) Ltd.
Liberty House, Hounslow Business Park, Southampton, Hampshire, SO40 9LR UK

Garmin Corporation
No. 68, Zhangshu 2nd Road, Xizhi Dist., New Taipei City, 221, Taiwan (R.O.C.)

www.garmin.com